

EconoPACK™4 Modul mit Trench/Feldstopp IGBT4 und Emitter Controlled Diode und NTC
EconoPACK™4 module with trench/fieldstop IGBT4 and Emitter Controlled Diode and NTC

Vorläufige Daten / Preliminary Data

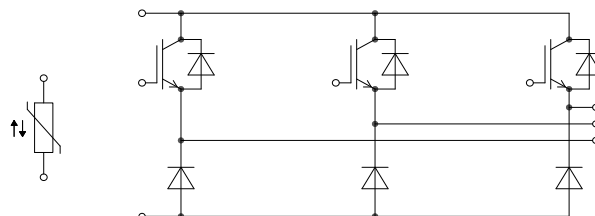
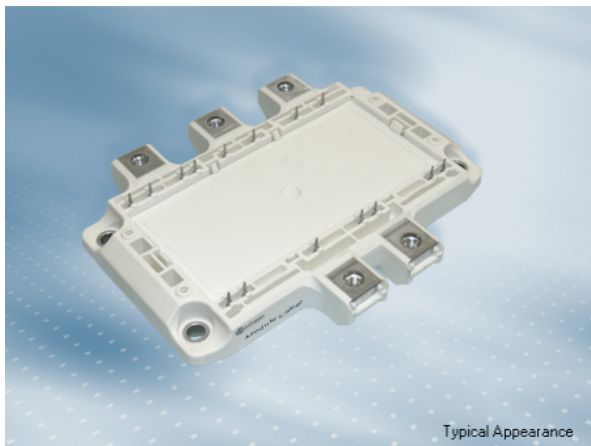

$V_{CES} = 650V$
 $I_{C\ nom} = 300A / I_{CRM} = 600A$

Typische Anwendungen

- Anwendungen mit hohen Schaltfrequenzen
- Chopper-Anwendungen
- Motorantriebe
- USV-Systeme

Typical Applications

- High Frequency Switching Application
- Chopper Applications
- Motor Drives
- UPS Systems

Elektrische Eigenschaften

- Erhöhte Sperrspannungsfestigkeit auf 650V
- Erweiterte Sperrschichttemperatur $T_{vj\ op}$
- Trench IGBT 4
- $T_{vj\ op} = 150^{\circ}C$
- V_{CESat} mit positivem Temperaturkoeffizienten

Electrical Features

- Increased blocking voltage capability to 650V
- Extended Operation Temperature $T_{vj\ op}$
- Trench IGBT 4
- $T_{vj\ op} = 150^{\circ}C$
- V_{CESat} with positive Temperature Coefficient

Mechanische Eigenschaften

- 4 kV AC 1min Isolationsfestigkeit
- Hohe mechanische Robustheit
- Integrierter NTC Temperatur Sensor
- Isolierte Bodenplatte
- Standardgehäuse

Mechanical Features

- 4 kV AC 1min Insulation
- High mechanical robustness
- Integrated NTC temperature sensor
- Isolated Base Plate
- Standard Housing

Module Label Code

Barcode Code 128



DMX - Code



Content of the Code

Digit

| | |
|----------------------------|---------|
| Module Serial Number | 1 - 5 |
| Module Material Number | 6 - 11 |
| Production Order Number | 12 - 19 |
| Datecode (Production Year) | 20 - 21 |
| Datecode (Production Week) | 22 - 23 |

| | | |
|-----------------|---------------------------------|----------------------|
| prepared by: AA | date of publication: 2013-11-11 | |
| approved by: MK | revision: 2.1 | UL approved (E83335) |



**Vorläufige Daten
Preliminary Data**

**IGBT, Brems-Chopper / IGBT, Brake-Chopper
Höchstzulässige Werte / Maximum Rated Values**

| | | | | |
|--|---|--------------------|-------|---|
| Kollektor-Emitter-Sperrspannung Collector-emitter voltage | $T_{vj} = 25^{\circ}\text{C}$ | V_{CES} | 650 | V |
| Kollektor-Dauergleichstrom Continuous DC collector current | $T_C = 70^{\circ}\text{C}, T_{vj\text{ max}} = 175^{\circ}\text{C}$ | $I_{C\text{ nom}}$ | 300 | A |
| Periodischer Kollektor-Spitzenstrom Repetitive peak collector current | $t_P = 1\text{ ms}$ | I_{CRM} | 600 | A |
| Gesamt-Verlustleistung Total power dissipation | $T_C = 25^{\circ}\text{C}, T_{vj\text{ max}} = 175^{\circ}\text{C}$ | P_{tot} | 940 | W |
| Gate-Emitter-Spitzenspannung Gate-emitter peak voltage | | V_{GES} | +/-20 | V |

Charakteristische Werte / Characteristic Values

| | | | min. | typ. | max. | |
|---|---|---|---------------------|----------------------|------|---|
| Kollektor-Emitter-Sättigungsspannung Collector-emitter saturation voltage | $I_C = 300\text{ A}, V_{GE} = 15\text{ V}$ $I_C = 300\text{ A}, V_{GE} = 15\text{ V}$ $I_C = 300\text{ A}, V_{GE} = 15\text{ V}$ | $T_{vj} = 25^{\circ}\text{C}$ $T_{vj} = 125^{\circ}\text{C}$ $T_{vj} = 150^{\circ}\text{C}$ | $V_{CE\text{ sat}}$ | 1,55 1,70 1,75 | 1,95 | V V V |
| Gate-Schwellenspannung Gate threshold voltage | $I_C = 4,80\text{ mA}, V_{CE} = V_{GE}, T_{vj} = 25^{\circ}\text{C}$ | | V_{GEth} | 5,0 5,8 | 6,5 | V |
| Gateladung Gate charge | $V_{GE} = -15\text{ V} \dots +15\text{ V}$ | | Q_G | 3,20 | | μC |
| Interner Gatewiderstand Internal gate resistor | $T_{vj} = 25^{\circ}\text{C}$ | | R_{Gint} | 1,0 | | Ω |
| Eingangskapazität Input capacitance | $f = 1\text{ MHz}, T_{vj} = 25^{\circ}\text{C}, V_{CE} = 25\text{ V}, V_{GE} = 0\text{ V}$ | | C_{ies} | 18,5 | | nF |
| Rückwirkungskapazität Reverse transfer capacitance | $f = 1\text{ MHz}, T_{vj} = 25^{\circ}\text{C}, V_{CE} = 25\text{ V}, V_{GE} = 0\text{ V}$ | | C_{res} | 0,57 | | nF |
| Kollektor-Emitter-Reststrom Collector-emitter cut-off current | $V_{CE} = 650\text{ V}, V_{GE} = 0\text{ V}, T_{vj} = 25^{\circ}\text{C}$ | | I_{CES} | | 1,0 | mA |
| Gate-Emitter-Reststrom Gate-emitter leakage current | $V_{CE} = 0\text{ V}, V_{GE} = 20\text{ V}, T_{vj} = 25^{\circ}\text{C}$ | | I_{GES} | | 400 | nA |
| Einschaltverzögerungszeit, induktive Last Turn-on delay time, inductive load | $I_C = 300\text{ A}, V_{CE} = 300\text{ V}$ $V_{GE} = \pm 15\text{ V}$ $R_{Gon} = 2,0\ \Omega$ | $T_{vj} = 25^{\circ}\text{C}$ $T_{vj} = 125^{\circ}\text{C}$ $T_{vj} = 150^{\circ}\text{C}$ | t_{don} | 0,08 0,09 0,09 | | μs μs μs |
| Anstiegszeit, induktive Last Rise time, inductive load | $I_C = 300\text{ A}, V_{CE} = 300\text{ V}$ $V_{GE} = \pm 15\text{ V}$ $R_{Gon} = 2,0\ \Omega$ | $T_{vj} = 25^{\circ}\text{C}$ $T_{vj} = 125^{\circ}\text{C}$ $T_{vj} = 150^{\circ}\text{C}$ | t_r | 0,06 0,06 0,06 | | μs μs μs |
| Abschaltverzögerungszeit, induktive Last Turn-off delay time, inductive load | $I_C = 300\text{ A}, V_{CE} = 300\text{ V}$ $V_{GE} = \pm 15\text{ V}$ $R_{Goff} = 2,0\ \Omega$ | $T_{vj} = 25^{\circ}\text{C}$ $T_{vj} = 125^{\circ}\text{C}$ $T_{vj} = 150^{\circ}\text{C}$ | t_{doff} | 0,38 0,43 0,43 | | μs μs μs |
| Fallzeit, induktive Last Fall time, inductive load | $I_C = 300\text{ A}, V_{CE} = 300\text{ V}$ $V_{GE} = \pm 15\text{ V}$ $R_{Goff} = 2,0\ \Omega$ | $T_{vj} = 25^{\circ}\text{C}$ $T_{vj} = 125^{\circ}\text{C}$ $T_{vj} = 150^{\circ}\text{C}$ | t_f | 0,15 0,25 0,26 | | μs μs μs |
| Einschaltverlustenergie pro Puls Turn-on energy loss per pulse | $I_C = 300\text{ A}, V_{CE} = 300\text{ V}, L_S = 30\text{ nH}$ $V_{GE} = \pm 15\text{ V}, di/dt = 4750\text{ A}/\mu\text{s} (T_{vj} = 150^{\circ}\text{C})$ $R_{Gon} = 2,0\ \Omega$ | $T_{vj} = 25^{\circ}\text{C}$ $T_{vj} = 125^{\circ}\text{C}$ $T_{vj} = 150^{\circ}\text{C}$ | E_{on} | 2,80 3,85 4,30 | | mJ mJ mJ |
| Abschaltverlustenergie pro Puls Turn-off energy loss per pulse | $I_C = 300\text{ A}, V_{CE} = 300\text{ V}, L_S = 30\text{ nH}$ $V_{GE} = \pm 15\text{ V}, du/dt = 3200\text{ V}/\mu\text{s} (T_{vj} = 150^{\circ}\text{C})$ $R_{Goff} = 2,0\ \Omega$ | $T_{vj} = 25^{\circ}\text{C}$ $T_{vj} = 125^{\circ}\text{C}$ $T_{vj} = 150^{\circ}\text{C}$ | E_{off} | 12,5 15,5 16,5 | | mJ mJ mJ |
| Kurzschlußverhalten SC data | $V_{GE} \leq 15\text{ V}, V_{CC} = 360\text{ V}$ $V_{CEmax} = V_{CES} - L_{SCE} \cdot di/dt$ | $t_P \leq 10\ \mu\text{s}, T_{vj} = 25^{\circ}\text{C}$ $t_P \leq 10\ \mu\text{s}, T_{vj} = 150^{\circ}\text{C}$ | I_{SC} | 1500 1200 | | A A |
| Wärmewiderstand, Chip bis Gehäuse Thermal resistance, junction to case | pro IGBT / per IGBT | | R_{thJC} | | 0,16 | K/W |
| Wärmewiderstand, Gehäuse bis Kühlkörper Thermal resistance, case to heatsink | pro IGBT / per IGBT $\lambda_{Paste} = 1\text{ W}/(\text{m}\cdot\text{K}) / \lambda_{grease} = 1\text{ W}/(\text{m}\cdot\text{K})$ | | R_{thCH} | 0,093 | | K/W |
| Temperatur im Schaltbetrieb Temperature under switching conditions | | | $T_{vj\text{ op}}$ | -40 | 150 | $^{\circ}\text{C}$ |

| | |
|-----------------|---------------------------------|
| prepared by: AA | date of publication: 2013-11-11 |
| approved by: MK | revision: 2.1 |



**Vorläufige Daten
Preliminary Data**

**Diode, Brems-Chopper / Diode, Brake-Chopper
Höchstzulässige Werte / Maximum Rated Values**

| | | | | |
|---|--|-----------|--------------|--|
| Periodische Spitzensperrspannung Repetitive peak reverse voltage | $T_{vj} = 25^{\circ}\text{C}$ | V_{RRM} | 650 | V |
| Dauergleichstrom Continuous DC forward current | | I_F | 300 | A |
| Periodischer Spitzenstrom Repetitive peak forward current | $t_P = 1\text{ ms}$ | I_{FRM} | 600 | A |
| Grenzlastintegral I^2t - value | $V_R = 0\text{ V}, t_P = 10\text{ ms}, T_{vj} = 125^{\circ}\text{C}$ $V_R = 0\text{ V}, t_P = 10\text{ ms}, T_{vj} = 150^{\circ}\text{C}$ | I^2t | 6450 5950 | A^2s A^2s |

Charakteristische Werte / Characteristic Values

| | | | min. | typ. | max. | |
|---|---|---|--------------------|----------------------|------|---|
| Durchlassspannung Forward voltage | $I_F = 300\text{ A}, V_{GE} = 0\text{ V}$ $I_F = 300\text{ A}, V_{GE} = 0\text{ V}$ $I_F = 300\text{ A}, V_{GE} = 0\text{ V}$ | $T_{vj} = 25^{\circ}\text{C}$ $T_{vj} = 125^{\circ}\text{C}$ $T_{vj} = 150^{\circ}\text{C}$ | V_F | 1,55 1,50 1,45 | 1,95 | V V V |
| Rückstromspitze Peak reverse recovery current | $I_F = 300\text{ A}, -di_F/dt = 4750\text{ A}/\mu\text{s} (T_{vj}=150^{\circ}\text{C})$ $V_R = 300\text{ V}$ | $T_{vj} = 25^{\circ}\text{C}$ $T_{vj} = 125^{\circ}\text{C}$ $T_{vj} = 150^{\circ}\text{C}$ | I_{RM} | 170 225 235 | | A A A |
| Sperrverzögerungsladung Recovered charge | $I_F = 300\text{ A}, -di_F/dt = 4750\text{ A}/\mu\text{s} (T_{vj}=150^{\circ}\text{C})$ $V_R = 300\text{ V}$ | $T_{vj} = 25^{\circ}\text{C}$ $T_{vj} = 125^{\circ}\text{C}$ $T_{vj} = 150^{\circ}\text{C}$ | Q_r | 11,0 21,5 24,5 | | μC μC μC |
| Abschaltenergie pro Puls Reverse recovery energy | $I_F = 300\text{ A}, -di_F/dt = 4750\text{ A}/\mu\text{s} (T_{vj}=150^{\circ}\text{C})$ $V_R = 300\text{ V}$ | $T_{vj} = 25^{\circ}\text{C}$ $T_{vj} = 125^{\circ}\text{C}$ $T_{vj} = 150^{\circ}\text{C}$ | E_{rec} | 3,10 6,00 6,75 | | mJ mJ mJ |
| Wärmewiderstand, Chip bis Gehäuse Thermal resistance, junction to case | pro Diode / per diode | | R_{thJC} | | 0,32 | K/W |
| Wärmewiderstand, Gehäuse bis Kühlkörper Thermal resistance, case to heatsink | pro Diode / per diode $\lambda_{Paste} = 1\text{ W}/(\text{m}\cdot\text{K}) / \lambda_{grease} = 1\text{ W}/(\text{m}\cdot\text{K})$ | | R_{thCH} | 0,185 | | K/W |
| Temperatur im Schaltbetrieb Temperature under switching conditions | | | $T_{vj\text{ op}}$ | -40 | 150 | $^{\circ}\text{C}$ |

**Diode, Revers / Diode, Reverse
Höchstzulässige Werte / Maximum Rated Values**

| | | | | |
|---|--|-----------|--------------|--|
| Periodische Spitzensperrspannung Repetitive peak reverse voltage | $T_{vj} = 25^{\circ}\text{C}$ | V_{RRM} | 650 | V |
| Dauergleichstrom Continuous DC forward current | | I_F | 100 | A |
| Periodischer Spitzenstrom Repetitive peak forward current | $t_P = 1\text{ ms}$ | I_{FRM} | 200 | A |
| Grenzlastintegral I^2t - value | $V_R = 0\text{ V}, t_P = 10\text{ ms}, T_{vj} = 125^{\circ}\text{C}$ $V_R = 0\text{ V}, t_P = 10\text{ ms}, T_{vj} = 150^{\circ}\text{C}$ | I^2t | 1250 1150 | A^2s A^2s |

Charakteristische Werte / Characteristic Values

| | | | min. | typ. | max. | |
|---|---|---|--------------------|----------------------|------|--------------------|
| Durchlassspannung Forward voltage | $I_F = 100\text{ A}, V_{GE} = 0\text{ V}$ $I_F = 100\text{ A}, V_{GE} = 0\text{ V}$ $I_F = 100\text{ A}, V_{GE} = 0\text{ V}$ | $T_{vj} = 25^{\circ}\text{C}$ $T_{vj} = 125^{\circ}\text{C}$ $T_{vj} = 150^{\circ}\text{C}$ | V_F | 1,55 1,50 1,45 | 1,95 | V V V |
| Wärmewiderstand, Chip bis Gehäuse Thermal resistance, junction to case | pro Diode / per diode | | R_{thJC} | | 0,75 | K/W |
| Wärmewiderstand, Gehäuse bis Kühlkörper Thermal resistance, case to heatsink | pro Diode / per diode $\lambda_{Paste} = 1\text{ W}/(\text{m}\cdot\text{K}) / \lambda_{grease} = 1\text{ W}/(\text{m}\cdot\text{K})$ | | R_{thCH} | 0,435 | | K/W |
| Temperatur im Schaltbetrieb Temperature under switching conditions | | | $T_{vj\text{ op}}$ | -40 | 150 | $^{\circ}\text{C}$ |

| | |
|-----------------|---------------------------------|
| prepared by: AA | date of publication: 2013-11-11 |
| approved by: MK | revision: 2.1 |



**Vorläufige Daten
Preliminary Data**

**NTC-Widerstand / NTC-Thermistor
Charakteristische Werte / Characteristic Values**

| | | | min. | typ. | max. | |
|--|--|--------------|------|------|------|------------|
| Nennwiderstand Rated resistance | $T_C = 25^\circ\text{C}$ | R_{25} | | 5,00 | | k Ω |
| Abweichung von R100 Deviation of R100 | $T_C = 100^\circ\text{C}, R_{100} = 493 \Omega$ | $\Delta R/R$ | -5 | | 5 | % |
| Verlustleistung Power dissipation | $T_C = 25^\circ\text{C}$ | P_{25} | | | 20,0 | mW |
| B-Wert B-value | $R_2 = R_{25} \exp [B_{25/50}(1/T_2 - 1/(298,15 \text{ K}))]$ | $B_{25/50}$ | | 3375 | | K |
| B-Wert B-value | $R_2 = R_{25} \exp [B_{25/80}(1/T_2 - 1/(298,15 \text{ K}))]$ | $B_{25/80}$ | | 3411 | | K |
| B-Wert B-value | $R_2 = R_{25} \exp [B_{25/100}(1/T_2 - 1/(298,15 \text{ K}))]$ | $B_{25/100}$ | | 3433 | | K |

Angaben gemäß gültiger Application Note.
Specification according to the valid application note.

Modul / Module

| | | | | | | |
|--|--|-------------|------|--------------------------------|------|------------------|
| Isolations-Prüfspannung Isolation test voltage | RMS, f = 50 Hz, t = 1 min. | V_{ISOL} | | 4,0 | | kV |
| Material Modulgrundplatte Material of module baseplate | | | | Cu | | |
| Innere Isolation Internal insulation | Basisisolation (Schutzklasse 1, EN61140) basic insulation (class 1, IEC 61140) | | | Al ₂ O ₃ | | |
| Kriechstrecke Creepage distance | Kontakt - Kühlkörper / terminal to heatsink Kontakt - Kontakt / terminal to terminal | | | 15,0 12,5 | | mm |
| Luftstrecke Clearance | Kontakt - Kühlkörper / terminal to heatsink Kontakt - Kontakt / terminal to terminal | | | 11,0 7,0 | | mm |
| Vergleichszahl der Kriechwegbildung Comperative tracking index | | CTI | | > 200 | | |
| | | | min. | typ. | max. | |
| Wärmewiderstand, Gehäuse bis Kühlkörper Thermal resistance, case to heatsink | pro Modul / per module $\lambda_{Paste} = 1 \text{ W}/(\text{m}\cdot\text{K}) / \lambda_{grease} = 1 \text{ W}/(\text{m}\cdot\text{K})$ | R_{thCH} | | 0,009 | | K/W |
| Modulstreuinduktivität Stray inductance module | | L_{sCE} | | 20 | | nH |
| Modulleitungswiderstand, Anschlüsse - Chip Module lead resistance, terminals - chip | $T_C = 25^\circ\text{C}$, pro Schalter / per switch | R_{CC+EE} | | 1,40 | | m Ω |
| Lagertemperatur Storage temperature | | T_{stg} | -40 | | 125 | $^\circ\text{C}$ |
| Anzugsdrehmoment f. Modulmontage Mounting torque for modul mounting | Schraube M5 - Montage gem. gültiger Applikationsschrift Screw M5 - Mounting according to valid application note | M | 3,00 | - | 6,00 | Nm |
| Anzugsdrehmoment f. elektr. Anschlüsse Terminal connection torque | Schraube M6 - Montage gem. gültiger Applikationsschrift Screw M6 - Mounting according to valid application note | M | 3,0 | - | 6,0 | Nm |
| Gewicht Weight | | G | | 400 | | g |

Der Dauergleichstrom ist auf 225A @Tc=100°C, 240A @Tc=90°C und 300A @Tc=50°C rms pro Anschlussterminal begrenzt. (T_{terminal}=125°C)
The DC forward current is limited to 225A @Tc=100°C, 240A @Tc=90°C and 300A @Tc=50°C rms per connector terminal. (T_{terminal}=125°C)

| | |
|-----------------|---------------------------------|
| prepared by: AA | date of publication: 2013-11-11 |
| approved by: MK | revision: 2.1 |

**Vorläufige Daten
Preliminary Data**

**Ausgangskennlinie IGBT, Brems-Chopper (typisch)
output characteristic IGBT, Brake-Chopper (typical)**

$I_C = f(V_{CE})$
 $V_{GE} = 15\text{ V}$

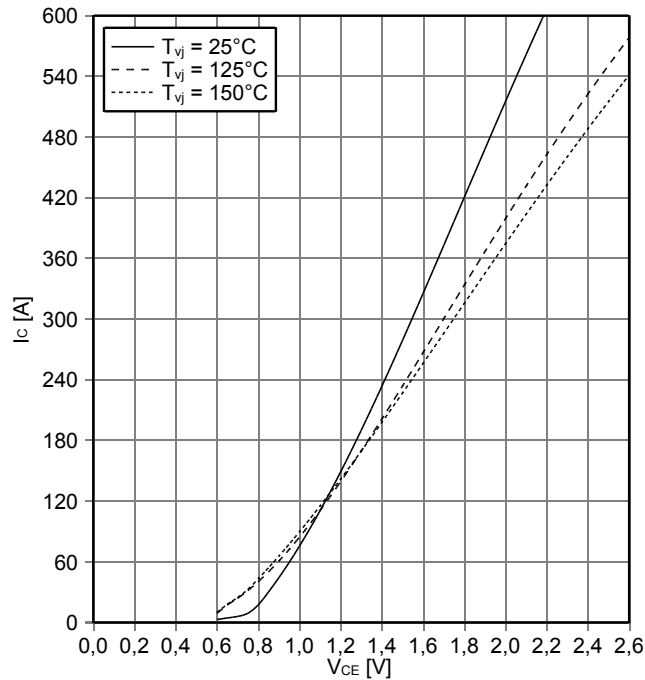

**Ausgangskennlinienfeld IGBT, Brems-Chopper (typisch)
output characteristic IGBT, Brake-Chopper (typical)**

$I_C = f(V_{CE})$
 $T_{vj} = 150^\circ\text{C}$

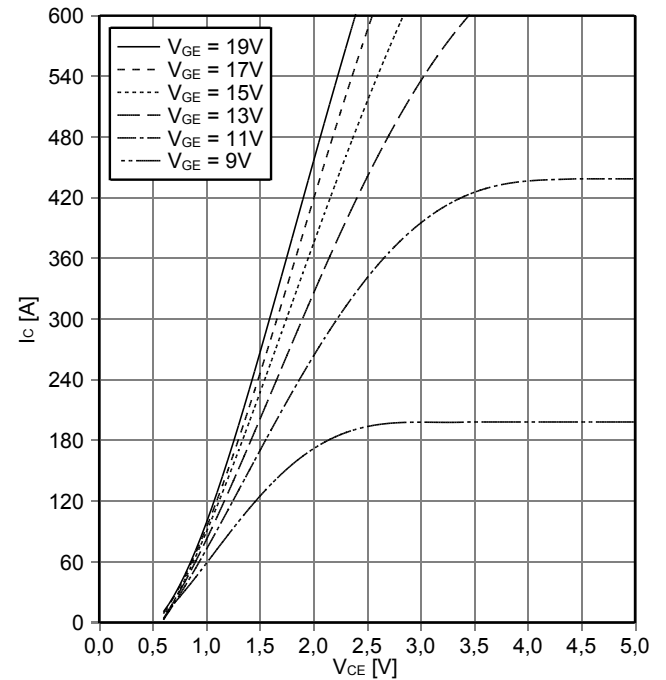

**Übertragungscharakteristik IGBT, Brems-Chopper (typisch)
transfer characteristic IGBT, Brake-Chopper (typical)**

$I_C = f(V_{GE})$
 $V_{CE} = 20\text{ V}$

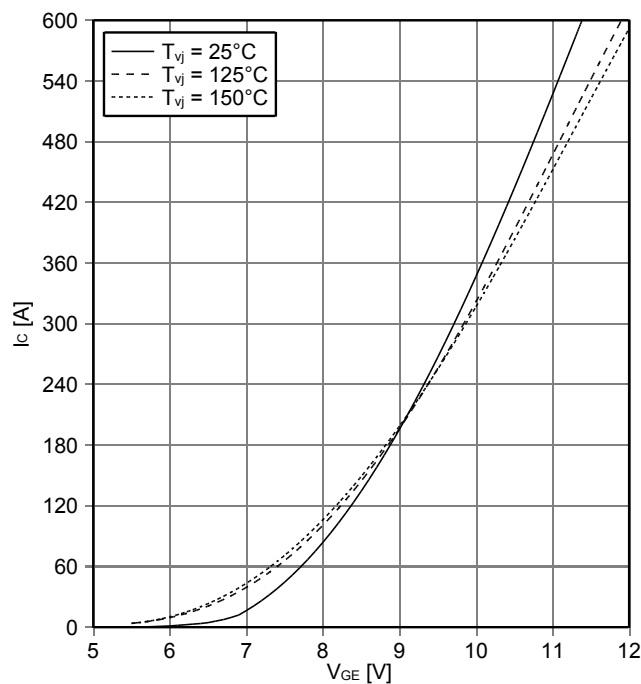

**Schaltverluste IGBT, Brems-Chopper (typisch)
switching losses IGBT, Brake-Chopper (typical)**

$E_{on} = f(I_C)$, $E_{off} = f(I_C)$
 $V_{GE} = \pm 15\text{ V}$, $R_{Gon} = 2\ \Omega$, $R_{Goff} = 2\ \Omega$, $V_{CE} = 300\text{ V}$

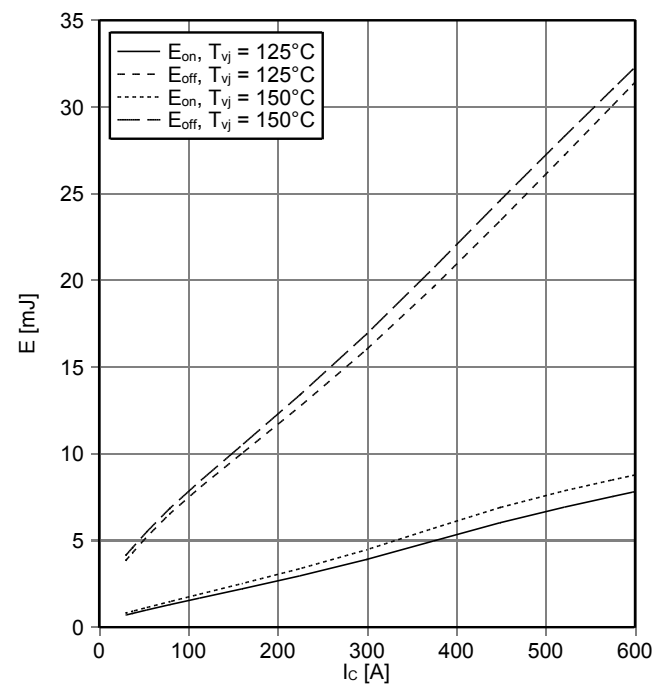

| | |
|-----------------|---------------------------------|
| prepared by: AA | date of publication: 2013-11-11 |
| approved by: MK | revision: 2.1 |

Vorläufige Daten
Preliminary Data

Schaltverluste IGBT, Brems-Chopper (typisch)
switching losses IGBT, Brake-Chopper (typical)

$E_{on} = f(R_G)$, $E_{off} = f(R_G)$
 $V_{GE} = \pm 15\text{ V}$, $I_C = 300\text{ A}$, $V_{CE} = 300\text{ V}$

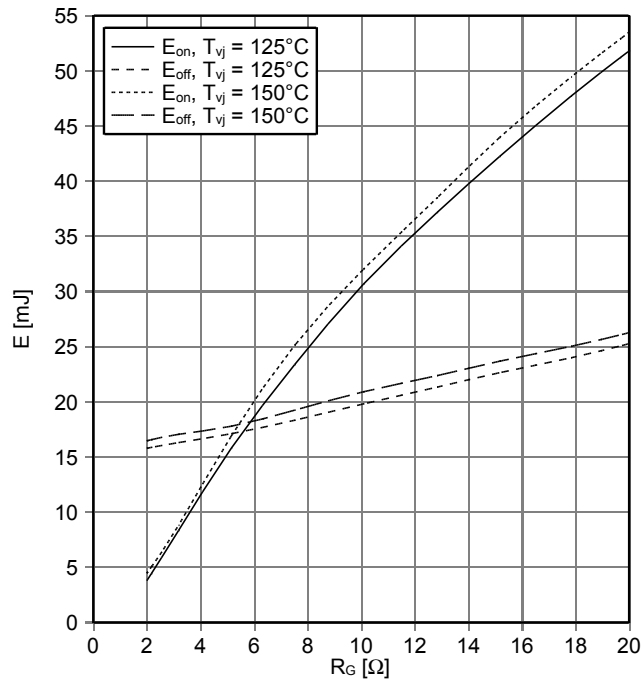

Transienter Wärmewiderstand IGBT, Brems-Chopper
transient thermal impedance IGBT, Brake-Chopper

$Z_{thJC} = f(t)$

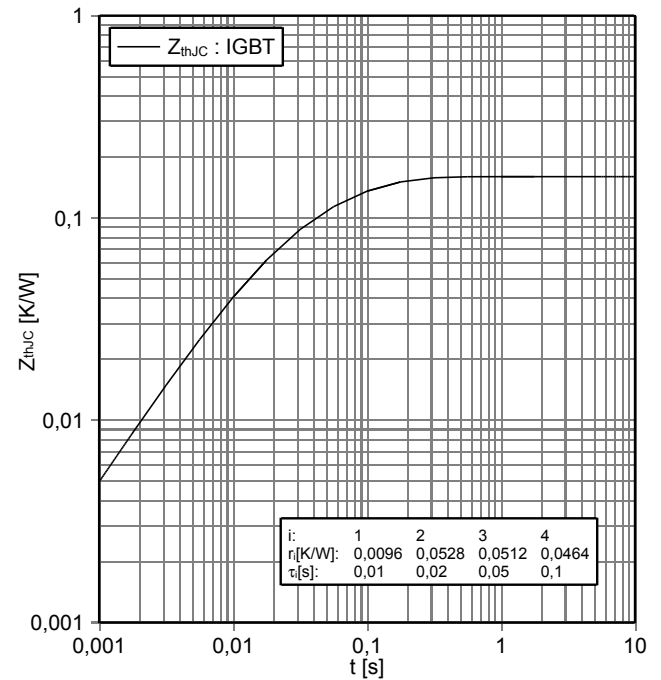

Sicherer Rückw.-Arbeitsber. IGBT, Brems-Chopper (RBSOA)
reverse bias safe operating area IGBT, Brake-Chopper (RBSOA)

$I_C = f(V_{CE})$
 $V_{GE} = \pm 15\text{ V}$, $R_{Goff} = 2\ \Omega$, $T_{vj} = 150^\circ\text{C}$

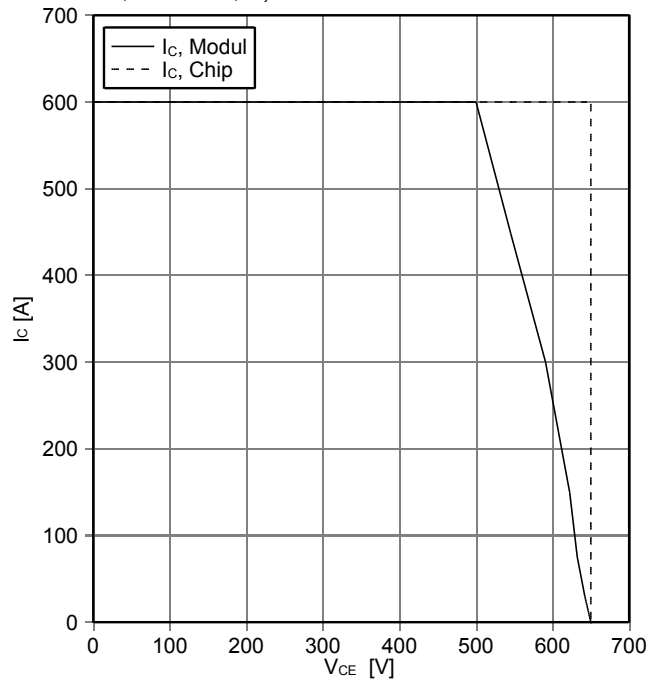

Durchlasskennlinie der Diode, Brems-Chopper (typisch)
forward characteristic of Diode, Brake-Chopper (typical)

$I_F = f(V_F)$

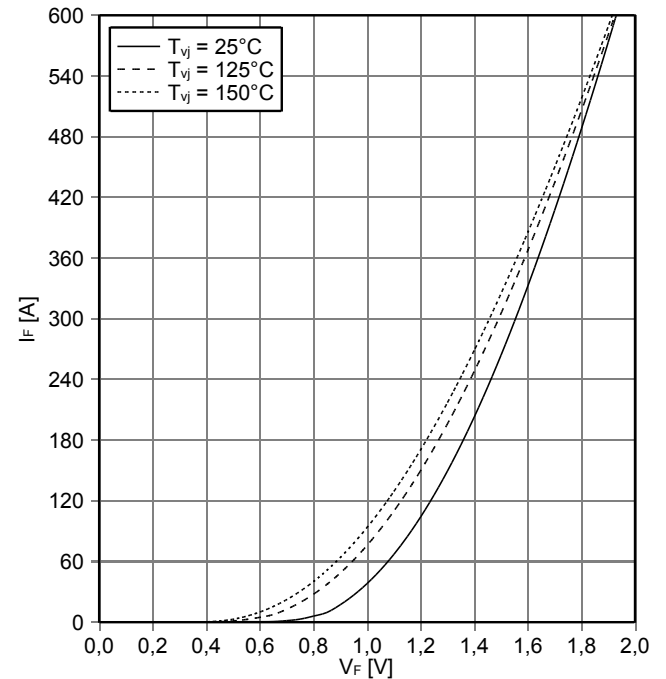

| | |
|-----------------|---------------------------------|
| prepared by: AA | date of publication: 2013-11-11 |
| approved by: MK | revision: 2.1 |

Vorläufige Daten
Preliminary Data

Schaltverluste Diode, Brems-Chopper (typisch)
switching losses Diode, Brake-Chopper (typical)

$E_{rec} = f(I_F)$
 $R_{Gon} = 2 \Omega, V_{CE} = 300 V$

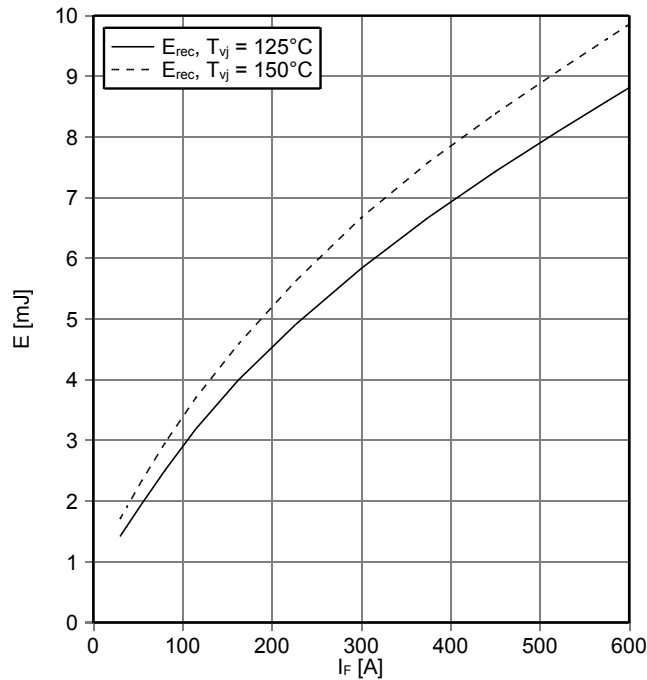

Schaltverluste Diode, Brems-Chopper (typisch)
switching losses Diode, Brake-Chopper (typical)

$E_{rec} = f(R_G)$
 $I_F = 300 A, V_{CE} = 300 V$

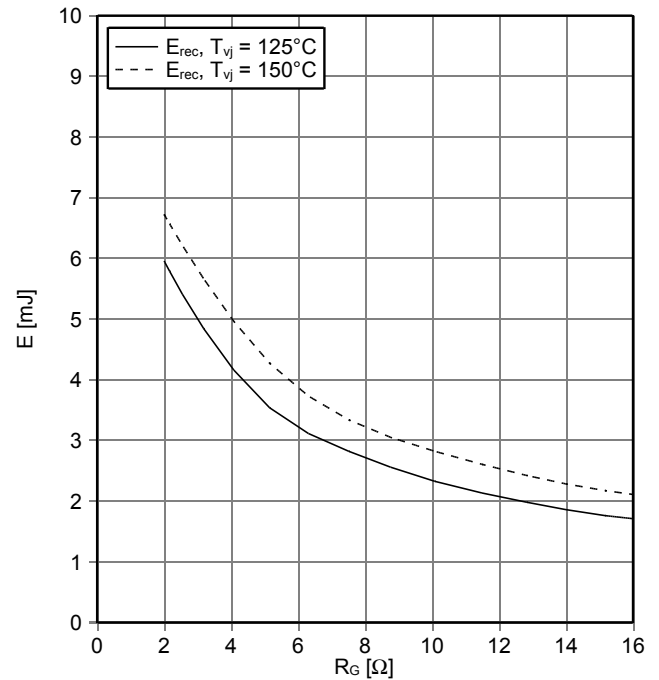

Transienter Wärmewiderstand Diode, Brems-Chopper
transient thermal impedance Diode, Brake-Chopper

$Z_{thJC} = f(t)$

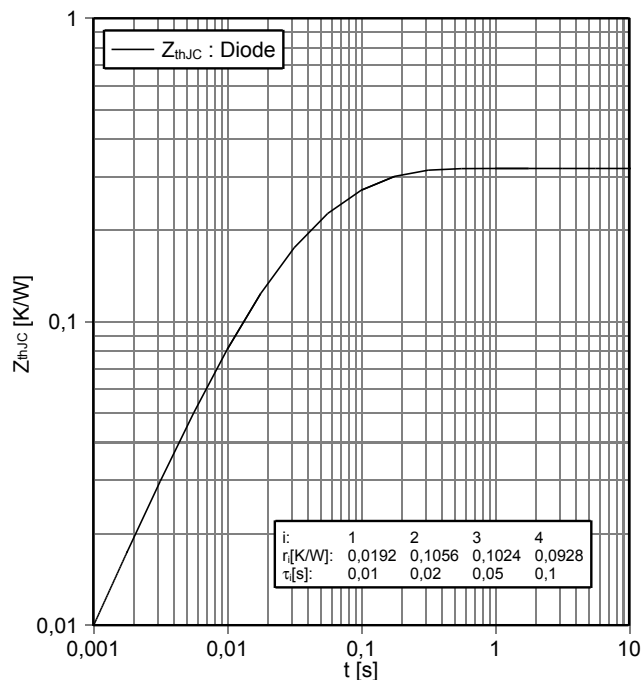

Durchlasskennlinie der Diode, Revers (typisch)
forward characteristic of Diode, Reverse (typical)

$I_F = f(V_F)$

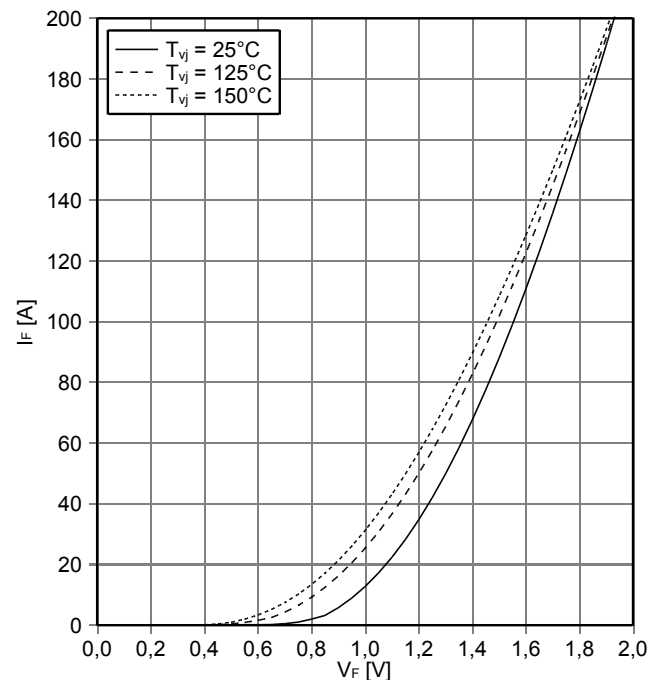

| | |
|-----------------|---------------------------------|
| prepared by: AA | date of publication: 2013-11-11 |
| approved by: MK | revision: 2.1 |



**Vorläufige Daten
Preliminary Data**

Transienter Wärmewiderstand Diode, Revers
transient thermal impedance Diode, Reverse
 $Z_{thJC} = f(t)$

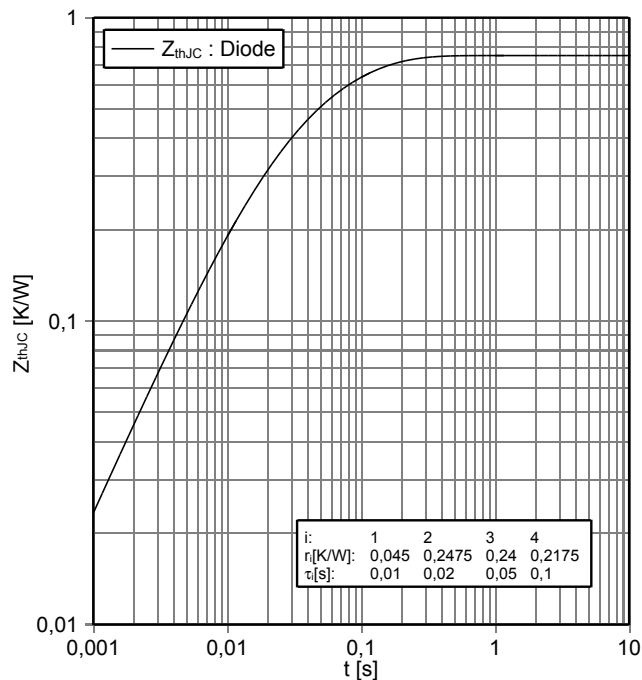

NTC-Widerstand-Temperaturkennlinie (typisch)
NTC-Thermistor-temperature characteristic (typical)
 $R = f(T)$

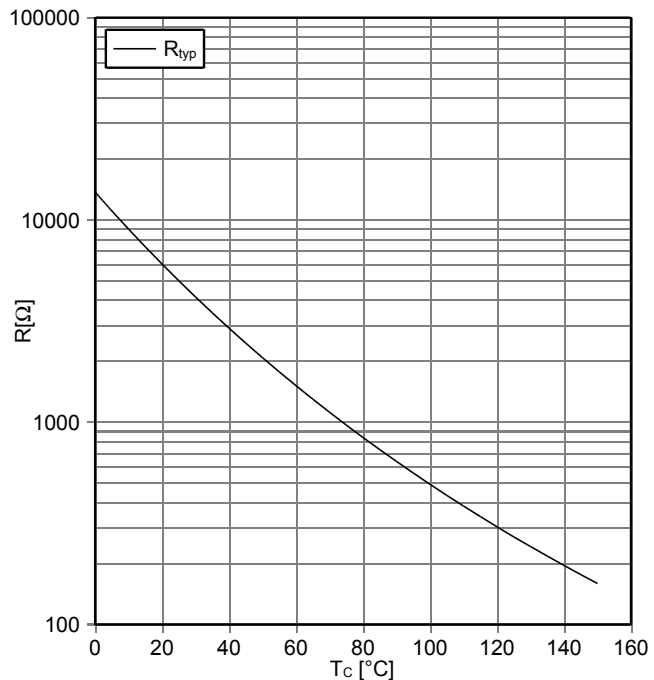

| | |
|-----------------|---------------------------------|
| prepared by: AA | date of publication: 2013-11-11 |
| approved by: MK | revision: 2.1 |

Vorläufige Daten
Preliminary Data

Schaltplan / circuit_diagram_headline

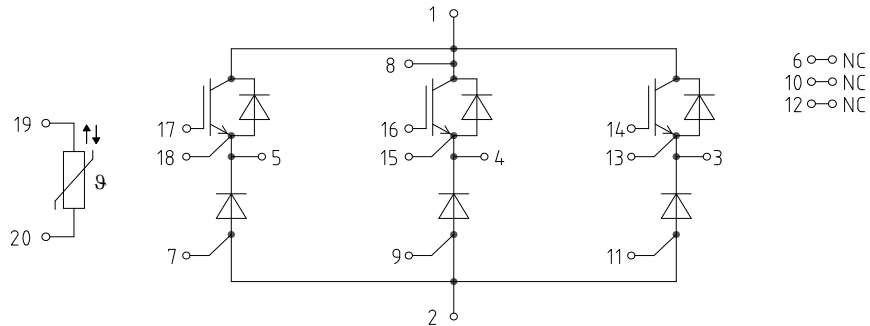

Gehäuseabmessungen / package outlines

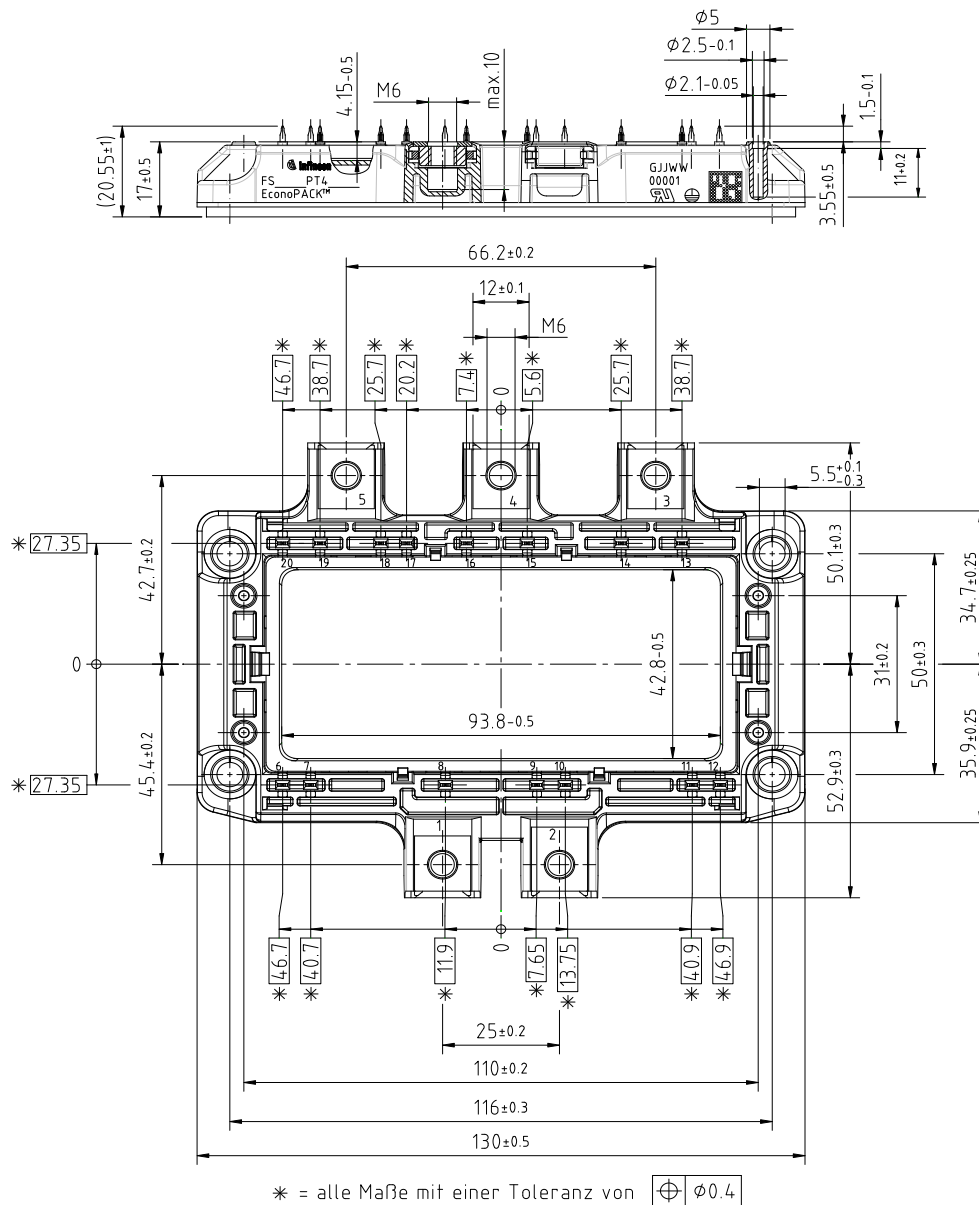

prepared by: AA
approved by: MK

date of publication: 2013-11-11
revision: 2.1



Vorläufige Daten Preliminary Data

Nutzungsbedingungen

Die in diesem Produktdatenblatt enthaltenen Daten sind ausschließlich für technisch geschultes Fachpersonal bestimmt. Die Beurteilung der Eignung dieses Produktes für Ihre Anwendung sowie die Beurteilung der Vollständigkeit der bereitgestellten Produktdaten für diese Anwendung obliegt Ihnen bzw. Ihren technischen Abteilungen.

In diesem Produktdatenblatt werden diejenigen Merkmale beschrieben, für die wir eine liefervertragliche Gewährleistung übernehmen. Eine solche Gewährleistung richtet sich ausschließlich nach Maßgabe der im jeweiligen Liefervertrag enthaltenen Bestimmungen. Garantien jeglicher Art werden für das Produkt und dessen Eigenschaften keinesfalls übernommen. Die Angaben in den gültigen Anwendungs- und Montagehinweisen des Moduls sind zu beachten.

Sollten Sie von uns Produktinformationen benötigen, die über den Inhalt dieses Produktdatenblatts hinausgehen und insbesondere eine spezifische Verwendung und den Einsatz dieses Produktes betreffen, setzen Sie sich bitte mit dem für Sie zuständigen Vertriebsbüro in Verbindung (siehe www.infineon.com, Vertrieb&Kontakt). Für Interessenten halten wir Application Notes bereit.

Aufgrund der technischen Anforderungen könnte unser Produkt gesundheitsgefährdende Substanzen enthalten. Bei Rückfragen zu den in diesem Produkt jeweils enthaltenen Substanzen setzen Sie sich bitte ebenfalls mit dem für Sie zuständigen Vertriebsbüro in Verbindung.

Sollten Sie beabsichtigen, das Produkt in Anwendungen der Luftfahrt, in gesundheits- oder lebensgefährdenden oder lebenserhaltenden Anwendungsbereichen einzusetzen, bitten wir um Mitteilung. Wir weisen darauf hin, dass wir für diese Fälle

- die gemeinsame Durchführung eines Risiko- und Qualitätsassessments;
- den Abschluss von speziellen Qualitätssicherungsvereinbarungen;
- die gemeinsame Einführung von Maßnahmen zu einer laufenden Produktbeobachtung dringend empfehlen und gegebenenfalls die Belieferung von der Umsetzung solcher Maßnahmen abhängig machen.

Soweit erforderlich, bitten wir Sie, entsprechende Hinweise an Ihre Kunden zu geben.

Inhaltliche Änderungen dieses Produktdatenblatts bleiben vorbehalten.

Terms & Conditions of usage

The data contained in this product data sheet is exclusively intended for technically trained staff. You and your technical departments will have to evaluate the suitability of the product for the intended application and the completeness of the product data with respect to such application.

This product data sheet is describing the characteristics of this product for which a warranty is granted. Any such warranty is granted exclusively pursuant the terms and conditions of the supply agreement. There will be no guarantee of any kind for the product and its characteristics. The information in the valid application- and assembly notes of the module must be considered.

Should you require product information in excess of the data given in this product data sheet or which concerns the specific application of our product, please contact the sales office, which is responsible for you (see www.infineon.com). For those that are specifically interested we may provide application notes.

Due to technical requirements our product may contain dangerous substances. For information on the types in question please contact the sales office, which is responsible for you.

Should you intend to use the Product in aviation applications, in health or live endangering or life support applications, please notify. Please note, that for any such applications we urgently recommend

- to perform joint Risk and Quality Assessments;
- the conclusion of Quality Agreements;
- to establish joint measures of an ongoing product survey, and that we may make delivery depended on the realization of any such measures.

If and to the extent necessary, please forward equivalent notices to your customers.

Changes of this product data sheet are reserved.

| | |
|-----------------|---------------------------------|
| prepared by: AA | date of publication: 2013-11-11 |
| approved by: MK | revision: 2.1 |

Данный компонент на территории Российской Федерации

Вы можете приобрести в компании MosChip.

Для оперативного оформления запроса Вам необходимо перейти по данной ссылке:

<http://moschip.ru/get-element>

Вы можете разместить у нас заказ для любого Вашего проекта, будь то серийное производство или разработка единичного прибора.

В нашем ассортименте представлены ведущие мировые производители активных и пассивных электронных компонентов.

Нашей специализацией является поставка электронной компонентной базы двойного назначения, продукции таких производителей как XILINX, Intel (ex.ALTERA), Vicor, Microchip, Texas Instruments, Analog Devices, Mini-Circuits, Amphenol, Glenair.

Сотрудничество с глобальными дистрибьюторами электронных компонентов, предоставляет возможность заказывать и получать с международных складов практически любой перечень компонентов в оптимальные для Вас сроки.

На всех этапах разработки и производства наши партнеры могут получить квалифицированную поддержку опытных инженеров.

Система менеджмента качества компании отвечает требованиям в соответствии с ГОСТ Р ИСО 9001, ГОСТ РВ 0015-002 и ЭС РД 009

Офис по работе с юридическими лицами:

105318, г.Москва, ул.Щербаковская д.3, офис 1107, 1118, ДЦ «Щербаковский»

Телефон: +7 495 668-12-70 (многоканальный)

Факс: +7 495 668-12-70 (доб.304)

E-mail: info@moschip.ru

Skype отдела продаж:

moschip.ru

moschip.ru_4

moschip.ru_6

moschip.ru_9