

## ADA4627-1/ADA4637-1

### FEATURES

**Low offset voltage: 200  $\mu$ V maximum**  
**Offset drift: 1  $\mu$ V/ $^{\circ}$ C typical**  
**Very low input bias current: 5 pA maximum**  
**Extended temperature range:  $-40^{\circ}$ C to  $+125^{\circ}$ C**  
 **$\pm 5$  V to  $\pm 15$  V dual supply**  
**ADA4627-1 GBW: 19 MHz**  
**ADA4637-1 GBW: 79 MHz**  
**Voltage noise: 6.1 nV/ $\sqrt{\text{Hz}}$  at 1 kHz**  
**ADA4627-1 slew rate: 82 V/ $\mu$ s**  
**ADA4637-1 slew rate: 170 V/ $\mu$ s**  
**High gain: 120 dB typical**  
**High CMRR: 116 dB typical**  
**High PSRR: 112 dB typical**

### APPLICATIONS

**High impedance sensors**  
**Photodiode amplifier**  
**Precision instrumentation**  
**Phase-locked loop filters**  
**High end, professional audio**  
**DAC output amplifier**  
**ATE**  
**Medical**

### GENERAL DESCRIPTION

The ADA4627-1/ADA4637-1 are wide bandwidth precision amplifiers featuring low noise, very low offset, drift, and bias current. The parts operate from  $\pm 5$  V to  $\pm 15$  V dual supply.

The ADA4627-1/ADA4637-1 provide benefits previously found in few amplifiers. These amplifiers combine the best specifications of precision dc and high speed ac op amps. The ADA4637-1 is a decompensated version of the ADA4627-1 and is stable at a noise gain of 5 or greater.

With a typical offset voltage of only 70  $\mu$ V, drift of less than 1  $\mu$ V/ $^{\circ}$ C, and noise of only 0.86  $\mu$ V p-p (0.1 Hz to 10 Hz), the ADA4627-1/ADA4637-1 are suited for applications where error sources cannot be tolerated.

**Table 1. High Speed Precision Op Amps**

| Supply | 5 V Low Cost | 5 V    | 26 V Low Power | 30 V Low Cost | 30 V                |
|--------|--------------|--------|----------------|---------------|---------------------|
| Single | AD8615       | AD8651 | AD8610         | AD8510        | ADA4627-1/ADA4637-1 |
| Dual   | AD8616       | AD8652 | AD8620         | AD8512        |                     |
| Quad   | AD8618       |        |                | AD8513        |                     |

### PIN CONFIGURATIONS

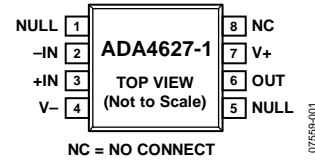

Figure 1. 8-Lead SOIC\_N (R-8)

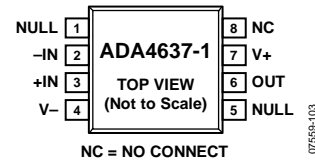
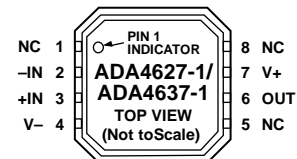

Figure 2. 8-Lead SOIC\_N (R-8)



**NOTES**  
 1. NC = NO CONNECT.  
 2. IT IS RECOMMENDED THAT THE EXPOSED PAD BE CONNECTED TO V-.

Figure 3. 8-Lead LFCSP\_VD (CP-8-2)

The ADA4627-1/ADA4637-1 are specified for both the industrial temperature range of  $-25^{\circ}$ C to  $+85^{\circ}$ C and the extended industrial temperature range of  $-40^{\circ}$ C to  $+125^{\circ}$ C. The ADA4627-1/ADA4637-1 are available in tiny 8-lead LFCSP and 8-lead SOIC packages.

The ADA4627-1/ADA4637-1 are members of a growing series of high speed, precision op amps offered by Analog Devices, Inc. (see Table 1).

### Rev. D

Information furnished by Analog Devices is believed to be accurate and reliable. However, no responsibility is assumed by Analog Devices for its use, nor for any infringements of patents or other rights of third parties that may result from its use. Specifications subject to change without notice. No license is granted by implication or otherwise under any patent or patent rights of Analog Devices. Trademarks and registered trademarks are the property of their respective owners.

**TABLE OF CONTENTS**

|   |    |   |    |
|---|----|---|----|
| Features .....                                  | 1  | Input Voltage Range .....                                 | 14 |
| Applications .....                              | 1  | Input Offset Voltage Adjust Range.....                    | 14 |
| Pin Configurations .....                        | 1  | Input Bias Current.....                                   | 14 |
| General Description .....                       | 1  | Noise Considerations.....                                 | 14 |
| Revision History .....                          | 2  | THD + N Measurements.....                                 | 15 |
| Specifications.....                             | 3  | Printed Circuit Board Layout, Bias Current, and Bypassing | 15 |
| Electrical Characteristics—30 V Operation ..... | 3  | Output Phase Reversal.....                                | 15 |
| Absolute Maximum Ratings.....                   | 5  | Decompensated Op Amps .....                               | 16 |
| Thermal Resistance .....                        | 5  | Driving Capacitive Loads.....                             | 16 |
| ESD Caution.....                                | 5  | Outline Dimensions .....                                  | 17 |
| Typical Performance Characteristics .....       | 6  | Ordering Guide .....                                      | 18 |
| Theory of Operation .....                       | 14 |   |    |

**REVISION HISTORY**

**10/10—Rev. C to Rev. D**

|  |    |
|--|----|
| Changes to Figure 1 and General Description..... | 1  |
| Changes to Ordering Guide .....                  | 18 |

**7/10—Rev. B to Rev. C**

|   |           |
|---|-----------|
| Added ADA4637-1.....  | Universal |
| Added Figure 2; Renumbered Sequentially .....               | 1         |
| Changes to Table 2.....                                     | 3         |
| Change to Table 3 .....                                     | 5         |
| Changes to Typical Performance Characteristics Section..... | 6         |
| Updated Outline Dimensions .....                            | 17        |
| Changes to Ordering Guide .....                             | 18        |

**10/09—Rev. A to Rev. B**

|                          |   |
|--------------------------|---|
| Changes to Figure 2..... | 1 |
|--------------------------|---|

**9/09—Rev. 0 to Rev. A**

|  |    |
|--|----|
| Changes to General Description Section ..... | 1  |
| Changes to Table 2.....                      | 3  |
| Updated Outline Dimensions.....              | 14 |
| Changes to Ordering Guide .....              | 15 |

**7/09—Revision 0: Initial Version**

# SPECIFICATIONS

## ELECTRICAL CHARACTERISTICS—30 V OPERATION

$V_{SY} = \pm 15\text{ V}$ ,  $V_{CM} = 0\text{ V}$ ,  $T_A = 25^\circ\text{C}$ , unless otherwise noted.

Table 2.

| Parameter                            | Symbol                   | Test Conditions/Comments   | B Grade |                    |       | A Grade |                    |                        | Unit                         |
|--------------------------------------|--------------------------|--|---------|--------------------|-------|---------|--------------------|------------------------|------------------------------|
|                                      |                          |  | Min     | Typ                | Max   | Min     | Typ                | Max                    |                              |
| INPUT CHARACTERISTICS                |                          |  |         |                    |       |         |                    |                        |                              |
| Offset Voltage <sup>1</sup>          | $V_{OS}$                 | $-40^\circ\text{C} \leq T_A \leq +85^\circ\text{C}$  |         | 70                 | 200   |         | 120                | 300                    | $\mu\text{V}$                |
|                                      |                          | $-40^\circ\text{C} \leq T_A \leq +125^\circ\text{C}$   |         |                    | 350   |         |                    | 410                    | $\mu\text{V}$                |
|                                      |                          | $-40^\circ\text{C} \leq T_A \leq +125^\circ\text{C}$   |         |                    |       | 400     |                    |                        | 660                          |
| Offset Voltage Drift, Average        | $\Delta V_{OS}/\Delta T$ | $-40^\circ\text{C} \leq T_A \leq +125^\circ\text{C}$   |         | 1                  | 2     |         | 1                  | 3                      | $\mu\text{V}/^\circ\text{C}$ |
| Power Supply Rejection Ratio         | PSRR                     | $V_{SY} = \pm 4.5\text{ V to } \pm 18\text{ V}$  | 106     | 112                |       | 103     | 108                |                        | dB                           |
|                                      |                          | $-40^\circ\text{C} \leq T_A \leq +125^\circ\text{C}$   | 101     |                    |       | 99      |                    |                        | dB                           |
| Input Bias Current <sup>2</sup>      | $I_B$                    | $-40^\circ\text{C} \leq T_A \leq +85^\circ\text{C}$  |         | 1                  | 5     |         | 1                  | 5                      | pA                           |
|                                      |                          | $-40^\circ\text{C} \leq T_A \leq +125^\circ\text{C}$   |         |                    | 0.5   |         |                    | 0.5                    | nA                           |
|                                      |                          | $-40^\circ\text{C} \leq T_A \leq +125^\circ\text{C}$   |         |                    | 2     |         |                    | 2                      | nA                           |
| Input Offset Current                 | $I_{OS}$                 | $-40^\circ\text{C} \leq T_A \leq +85^\circ\text{C}$  |         | 0.5                | 5     |         | 0.5                | 5                      | pA                           |
|                                      |                          | $-40^\circ\text{C} \leq T_A \leq +125^\circ\text{C}$   |         |                    | 0.5   |         |                    | 0.5                    | nA                           |
|                                      |                          | $-40^\circ\text{C} \leq T_A \leq +125^\circ\text{C}$   |         |                    | 2     |         |                    | 2                      | nA                           |
| NOISE PERFORMANCE                    |                          |  |         |                    |       |         |                    |                        |                              |
| Voltage Noise Density                | $e_n$                    | f = 10 Hz  |         | 16.5               | 40    |         | 16.5               | 40                     | nV/ $\sqrt{\text{Hz}}$       |
|                                      |                          | f = 100 Hz   |         | 7.9                | 20    |         | 7.9                | 20                     | nV/ $\sqrt{\text{Hz}}$       |
|                                      |                          | f = 1 kHz  |         | 6.1                | 8     |         | 6.1                | 8                      | nV/ $\sqrt{\text{Hz}}$       |
|                                      |                          | f = 10 kHz   |         | 4.8                | 6     |         | 4.8                | 6                      | nV/ $\sqrt{\text{Hz}}$       |
| Voltage Noise                        | $e_n$ p-p                | 0.1 Hz to 10 Hz  |         | 0.7                | 1.6   |         | 0.7                | 1.6                    | $\mu\text{V p-p}$            |
| Current Noise Density                | $i_n$                    | f = 100 Hz   |         | 1.6                |       | 2.5     |                    | fA/ $\sqrt{\text{Hz}}$ |                              |
| Current Noise                        | $i_n$ p-p                | 0.1 Hz to 10 Hz  |         | 30                 |       | 48      |                    | fA p-p                 |                              |
| Input Resistance                     | $R_{IN}$                 |  |         | 10                 |       | 10      |                    | T $\Omega$             |                              |
| Input Capacitance, Differential Mode | $C_{INDM}$               |  |         | 8                  |       | 8       |                    | pF                     |                              |
| Input Capacitance, Common Mode       | $C_{INCM}$               |  |         | 7                  |       | 7       |                    | pF                     |                              |
| Input Voltage Range                  | IVR                      |  | -11     |                    | +11   | -11     |                    | +11                    | V                            |
|                                      |                          | $-40^\circ\text{C} \leq T_A \leq +125^\circ\text{C}$   | -10.5   |                    | +10.5 | -10.5   |                    | +10.5                  | V                            |
| Common-Mode Rejection Ratio          | CMRR                     | $T_A = 25^\circ\text{C}$ ,<br>$V_{CM} = -11\text{ V to } +11\text{ V}$   | 106     | 116                |       | 100     | 110                |                        | dB                           |
|                                      |                          | $-40^\circ\text{C} \leq T_A \leq +125^\circ\text{C}$ ,<br>$V_{CM} = -10.5\text{ V to } +10.5\text{ V}$                     | 98      |                    |       | 97      |                    |                        | dB                           |
| Large Signal Voltage Gain            | $A_{VO}$                 | $R_L = 1\text{ k}\Omega$ , $V_O = -10\text{ V to } +10\text{ V}$   | 112     | 120                |       | 106     | 120                |                        | dB                           |
|                                      |                          | $-40 \leq T_A \leq +85^\circ\text{C}$  | 110     |                    |       | 104     |                    |                        | dB                           |
|                                      |                          | $-40 \leq T_A \leq +125^\circ\text{C}$   | 102     |                    |       | 100     |                    |                        | dB                           |
| DYNAMIC PERFORMANCE                  |                          |  |         |                    |       |         |                    |                        |                              |
| Slew Rate ADA4627-1                  | SR                       | $\pm 10\text{ V step}$ , $R_L = 1\text{ k}\Omega$ ,<br>$C_L = 100\text{ pF}$ , $A_V = +1$                                  | 40      | 56/78 <sup>3</sup> |       | 40      | 56/78 <sup>3</sup> |                        | V/ $\mu\text{s}$             |
|                                      | SR                       | $\pm 10\text{ V step}$ , $R_L = 1\text{ k}\Omega$ , $C_L = 100\text{ pF}$ ,<br>$R_s = R_f = 1\text{ k}\Omega$ , $A_V = -1$ | 40      | 82/84 <sup>3</sup> |       | 40      | 82/84 <sup>3</sup> |                        | V/ $\mu\text{s}$             |
| Slew Rate ADA4637-1                  | SR                       | $\pm 10\text{ V out}$ , $C_f = 4.8\text{ pF}$ , $A_V = -4$   |         | 170                |       | 170     |                    |                        | V/ $\mu\text{s}$             |
|                                      | SR                       | $\pm 10\text{ V out}$ , $C_f = 4.8\text{ pF}$ , $A_V = +5$   |         | 170                |       | 170     |                    |                        | V/ $\mu\text{s}$             |

# ADA4627-1/ADA4637-1

| Parameter                           | Symbol    | Test Conditions/Comments   | B Grade         |           |           | A Grade         |           |           | Unit      |    |
|-------------------------------------|-----------|--|-----------------|-----------|-----------|-----------------|-----------|-----------|-----------|----|
|                                     |           |  | Min             | Typ       | Max       | Min             | Typ       | Max       |           |    |
| Settling Time to 0.01%<br>ADA4627-1 | $t_s$     | $V_{IN} = 10\text{ V step}, C_L = 35\text{ pF},$<br>$R_L = +1\text{ k}\Omega, A_V = -1$  |                 | 550       |           | 550             |           | ns        |           |    |
| ADA4637-1                           |           | $V_{IN} = 10\text{ V step}, C_L = 35\text{ pF},$<br>$R_L = +1\text{ k}\Omega, A_V = -4$  |                 | 300       |           | 300             |           | ns        |           |    |
| Settling Time to 0.1%<br>ADA4627-1  | $t_s$     | $V_{IN} = 10\text{ V step}, C_L = 35\text{ pF},$<br>$R_L = +1\text{ k}\Omega, A_V = -1$  |                 | 450       |           | 450             |           | ns        |           |    |
| ADA4637-1                           |           | $V_{OUT} = 10\text{ V step}, C_L = 35\text{ pF},$<br>$R_L = +1\text{ k}\Omega, A_V = -4$   |                 | 200       |           | 200             |           | ns        |           |    |
| Gain Bandwidth Product<br>ADA4627-1 | GBP       | $R_L = 1\text{ k}\Omega, C_L = 20\text{ pF}, A_V = 1$<br>$A_V = 10$  | 16 <sup>4</sup> | 19        |           | 16 <sup>4</sup> | 19        | MHz       |           |    |
| ADA4637-1                           |           |  |                 | 79.9      |           | 79.9            |           |           |           |    |
| Phase Margin<br>ADA4627-1           | $\Phi_M$  | $R_L = 1\text{ k}\Omega, C_L = 20\text{ pF}, A_V = 1$<br>$A_V = 10$  |                 | 72        |           | 72              |           | Degrees   |           |    |
| ADA4637-1                           |           |  | 85              |           | 85        |                 |           |           |           |    |
| Total Harmonic Distortion + Noise   | THD + N   | $f = 1\text{ kHz}, A_V = 1, \text{ADA4627-1}$  |                 | 0.000045  |           |                 | 0.000045  |           | %         |    |
| POWER SUPPLY                        |           |  |                 |           |           |                 |           |           |           |    |
| Supply Current per Amplifier        | $I_{SY}$  | $I_O = 0\text{ mA}$<br>$-40^\circ\text{C} \leq T_A \leq +125^\circ\text{C}$  |                 | $\pm 7.0$ | $\pm 7.5$ |                 | $\pm 7.0$ | $\pm 7.5$ | mA        |    |
|                                     |           |  |                 |           |           | $\pm 7.8$       |           |           | $\pm 7.8$ | mA |
| OUTPUT CHARACTERISTICS              |           |  |                 |           |           |                 |           |           |           |    |
| Output Voltage High                 | $V_{OH}$  | $R_L = 1\text{ k}\Omega \text{ to } V_{CM}$<br>$-40^\circ\text{C} \leq T_A \leq +85^\circ\text{C}$<br>$-40^\circ\text{C} \leq T_A \leq +125^\circ\text{C}$ | 12.0            | 12.3      |           | 12.0            | 12.3      | V         |           |    |
|                                     |           |  | 11.8            |           |           | 11.8            |           | V         |           |    |
|                                     |           |  | 11.7            |           |           | 11.7            |           | V         |           |    |
| Output Voltage Low                  | $V_{OL}$  | $R_L = 1\text{ k}\Omega \text{ to } V_{CM}$<br>$-40^\circ\text{C} \leq T_A \leq +85^\circ\text{C}$<br>$-40^\circ\text{C} \leq T_A \leq +125^\circ\text{C}$ |                 | -12.7     | -12.3     |                 | -12.7     | -12.3     | V         |    |
|                                     |           |  |                 |           | -12.1     |                 |           |           | -12.1     | V  |
|                                     |           |  |                 |           | -12.0     |                 |           |           | -12.0     | V  |
| Output Current                      | $I_{OUT}$ | $V_O = \pm 10\text{ V}$  |                 | $\pm 45$  |           | $\pm 45$        |           | mA        |           |    |
| Short-Circuit Current               | $I_{SC}$  | $T_A = 25^\circ\text{C}$   |                 | +70/-55   |           | +70/-55         |           | mA        |           |    |
| Closed-Loop Output Impedance        | $Z_{OUT}$ | $f = 1\text{ MHz}, A_V = -100$   |                 | 41        |           | 41              |           | $\Omega$  |           |    |

<sup>1</sup>  $V_{OS}$  is measured fully warmed up.

<sup>2</sup> Tested/extrapolated from 125°C.

<sup>3</sup> Rising/falling.

<sup>4</sup> Not tested. Guaranteed by simulation and characterization.

## ABSOLUTE MAXIMUM RATINGS

Table 3.

| Parameter                               | Rating   |
|---|--|
| Supply Voltage                          | 36 V   |
| Input Voltage Range <sup>1</sup>        | (V <sub>-</sub> ) - 0.3 V to (V <sub>+</sub> ) + 0.3 V |
| Input Current <sup>1</sup>              | ±10 mA   |
| Differential Input Voltage <sup>2</sup> | ±V <sub>SY</sub>                                       |
| Output Short-Circuit Duration to GND    | Indefinite   |
| Storage Temperature Range               | -65°C to +150°C  |
| Operating Temperature Range             | -40°C to +125°C  |
| Junction Temperature Range              | -65°C to +150°C  |
| Lead Temperature (Soldering, 60 sec)    | 300°C  |
| ESD Human Body Model                    | 4 kV   |

<sup>1</sup> Input pin has clamp diodes to the power supply pins. Input current should be limited to 10 mA or less whenever input signals exceed the power supply rail by 0.3 V.

<sup>2</sup> Differential input voltage is limited to ±30 V or the supply voltage, whichever is less.

Stresses above those listed under Absolute Maximum Ratings may cause permanent damage to the device. This is a stress rating only; functional operation of the device at these or any other conditions above those indicated in the operational section of this specification is not implied. Exposure to absolute maximum rating conditions for extended periods may affect device reliability.

## THERMAL RESISTANCE

$\theta_{JA}$  is specified for the worst-case conditions, that is, a device soldered in a circuit board for surface-mount packages. This was measured using a standard 2-layer board. For the LFCSP package, the exposed pad should be soldered to a copper plane.

Table 4. Thermal Resistance

| Package Type          | $\theta_{JA}$ | $\theta_{JC}$ | Unit |
|-----------------------|---------------|---------------|------|
| 8-Lead SOIC_N (R-8)   | 155           | 45            | °C/W |
| 8-Lead LFCSP (CP-8-2) | 77            | 14            | °C/W |

## ESD CAUTION



**ESD (electrostatic discharge) sensitive device.** Charged devices and circuit boards can discharge without detection. Although this product features patented or proprietary protection circuitry, damage may occur on devices subjected to high energy ESD. Therefore, proper ESD precautions should be taken to avoid performance degradation or loss of functionality.

## TYPICAL PERFORMANCE CHARACTERISTICS

$T_A = 25^\circ\text{C}$ , unless otherwise noted.

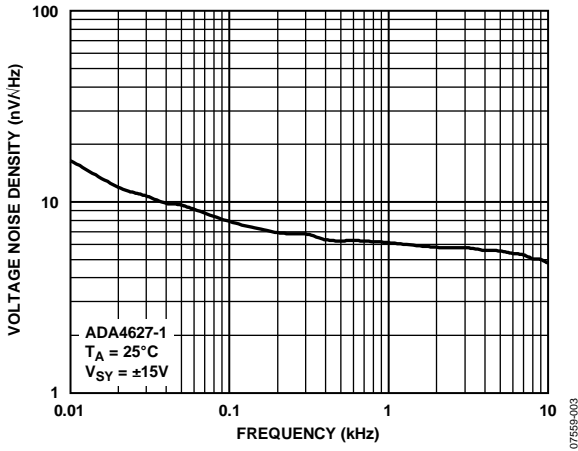

Figure 4. Voltage Noise Density vs. Frequency

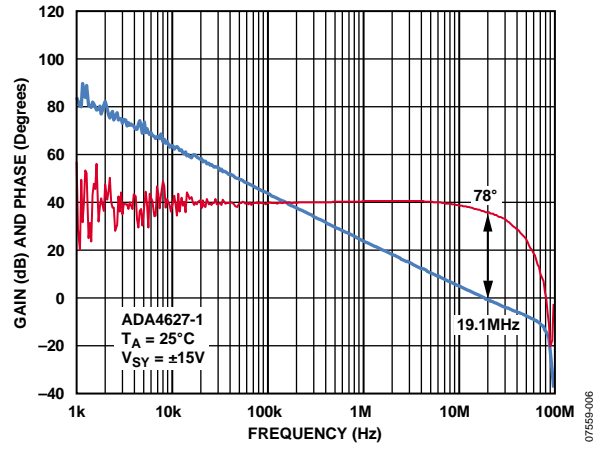

Figure 7. Open-Loop Gain and Phase vs. Frequency

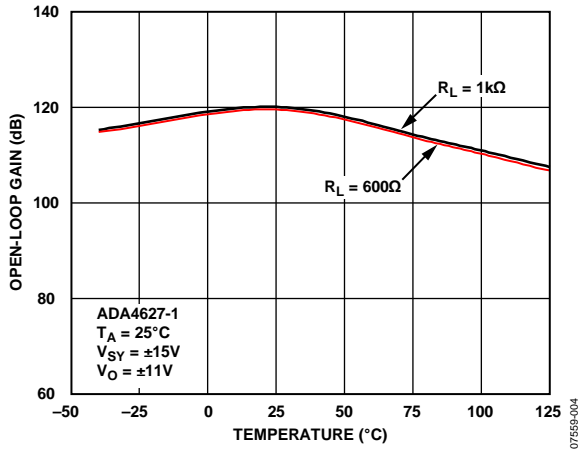

Figure 5. Open-Loop Gain vs. Temperature

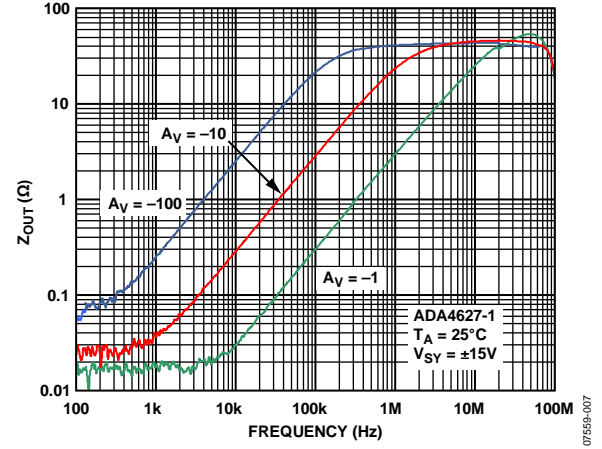

Figure 8. Closed-Loop  $Z_{OUT}$  vs. Frequency

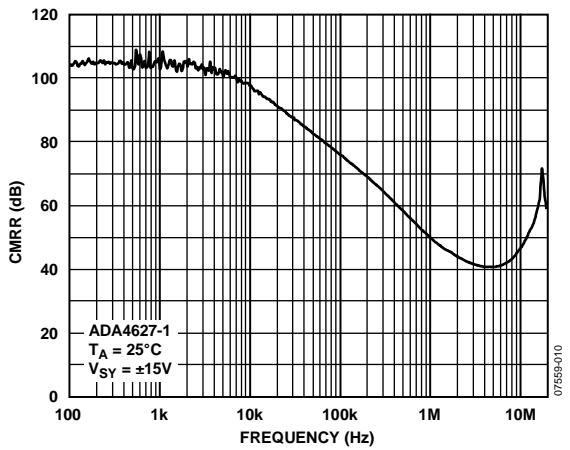

Figure 6. CMRR vs. Frequency

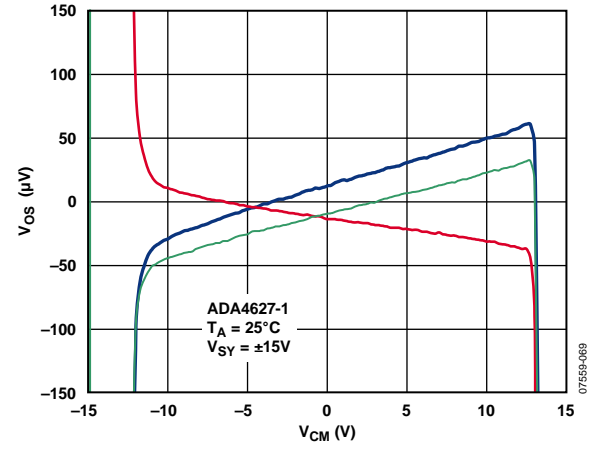

Figure 9.  $V_{OS}$  vs. Common-Mode Voltage

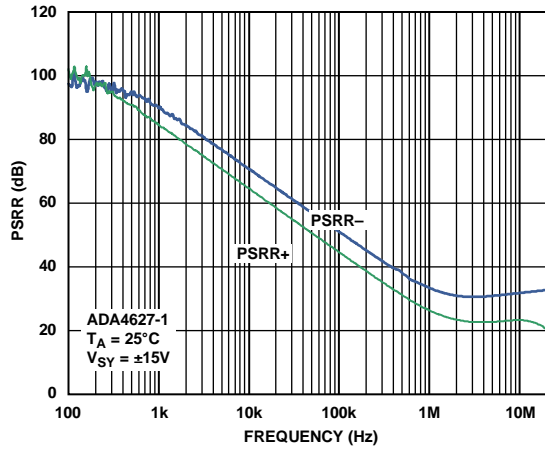

Figure 10. PSRR vs. Frequency

07559-009

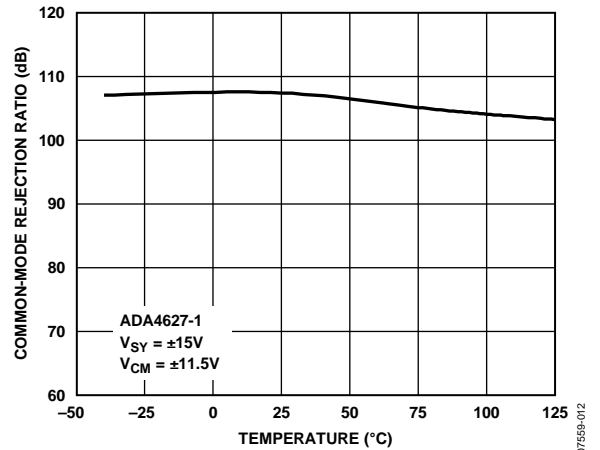

Figure 13. CMRR vs. Temperature

07559-012

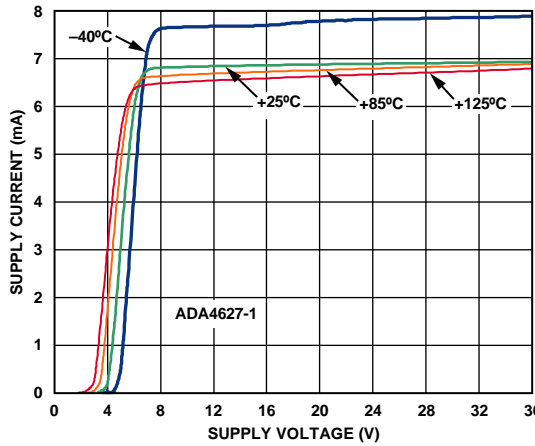

Figure 11. Supply Current vs. Supply Voltage and Temperature

07559-011

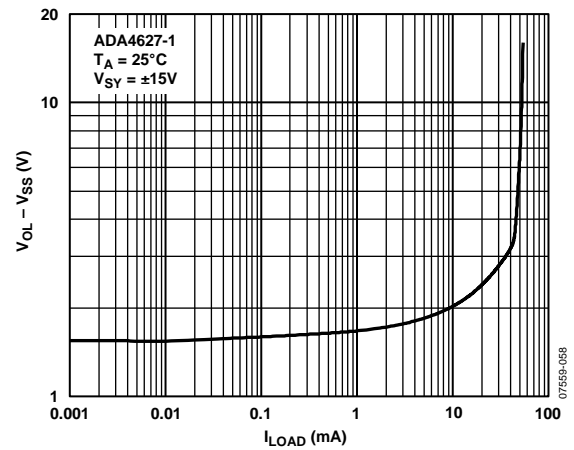

Figure 14.  $V_{OUT}$  Sinking vs.  $I_{LOAD}$  Current

07559-068

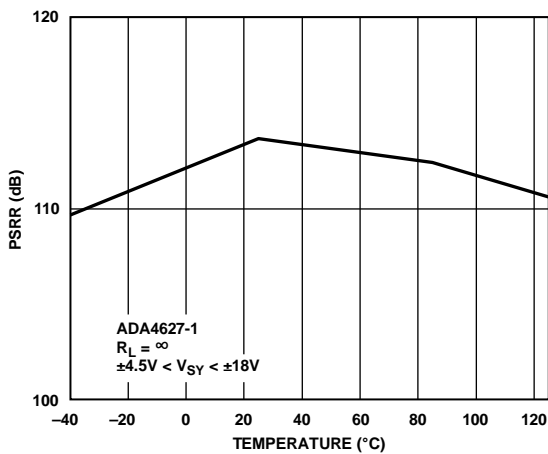

Figure 12. PSRR vs. Temperature

07559-068

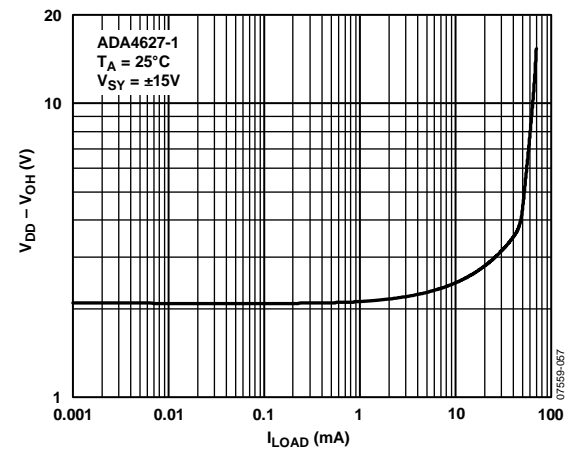

Figure 15.  $V_{OUT}$  Sourcing vs.  $I_{LOAD}$  Current

07559-067

# ADA4627-1/ADA4637-1

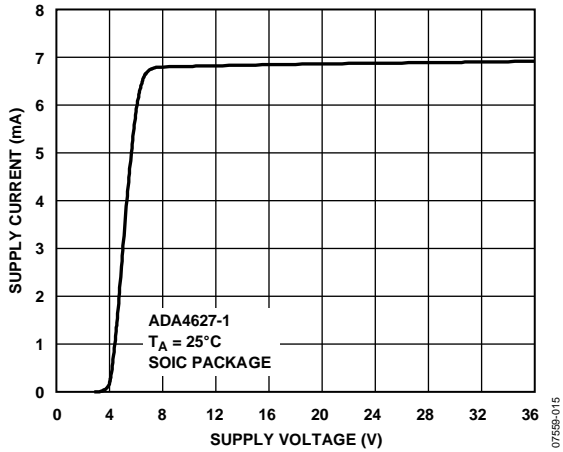

Figure 16. Supply Current vs. Supply Voltage

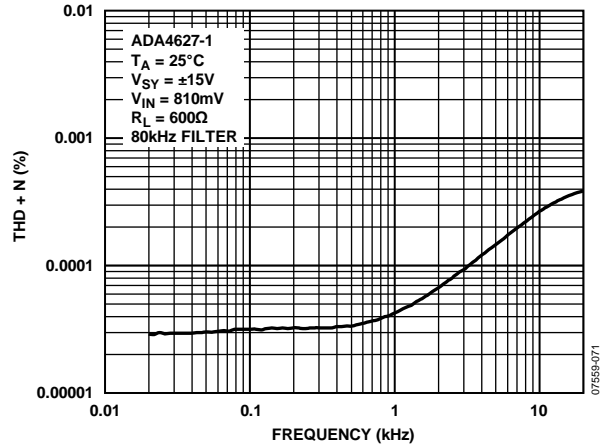

Figure 19. THD + N vs. Frequency

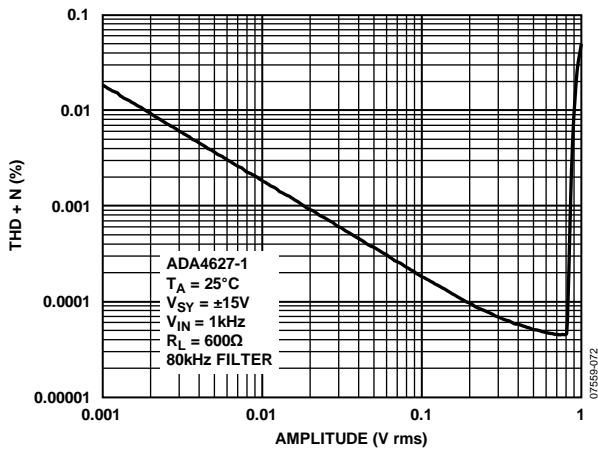

Figure 17. THD + N vs.  $V_{IN}$

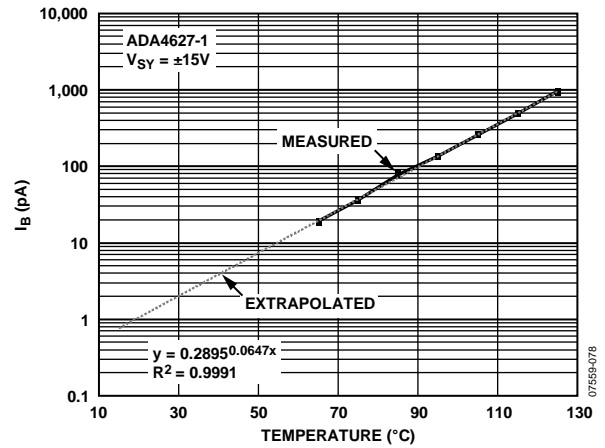

Figure 20. Input Bias Current vs. Temperature

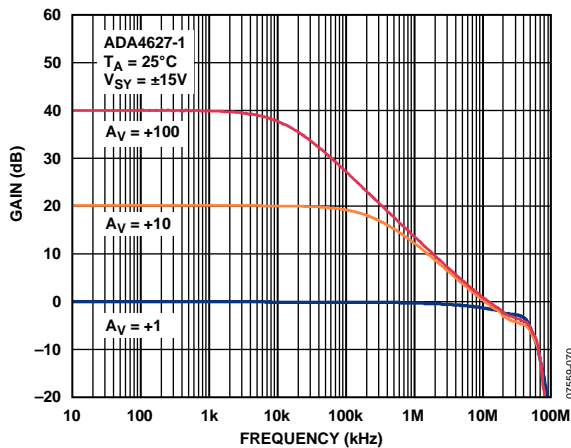

Figure 18. Closed-Loop Gain vs. Frequency

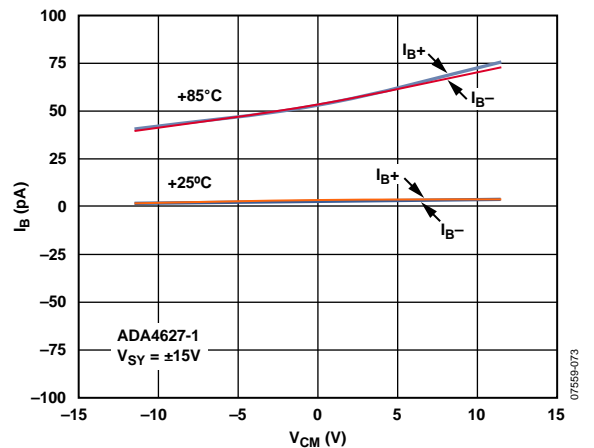

Figure 21. Input Bias Current vs.  $V_{CM}$  and Temperature



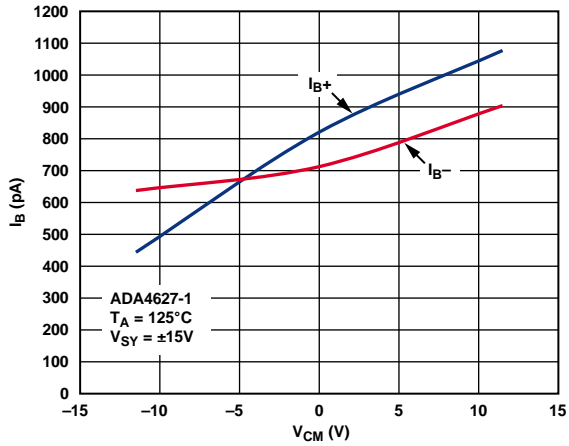

Figure 22. Input Bias Current vs.  $V_{CM}$  at  $125^\circ\text{C}$

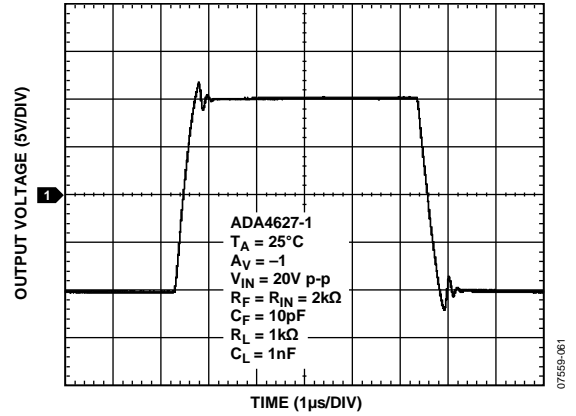

Figure 25. Large Signal Transient Response

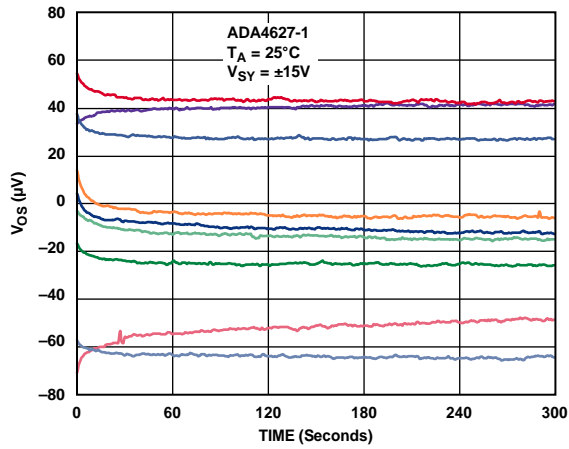

Figure 23. Input Offset Voltage vs. Time

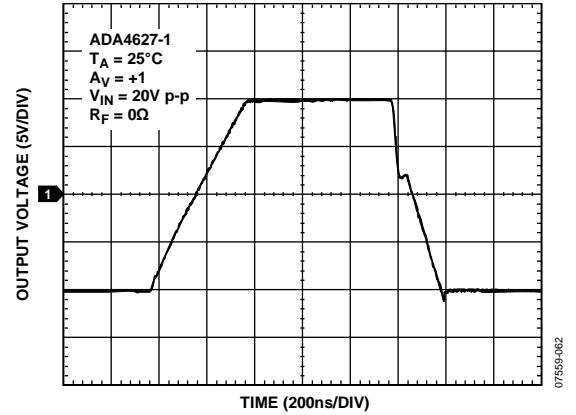

Figure 26. Large Signal Transient Response

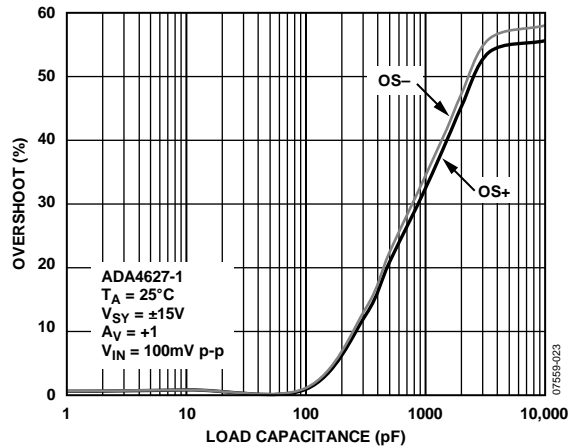

Figure 24. Small Signal Overshoot vs. Load Capacitance

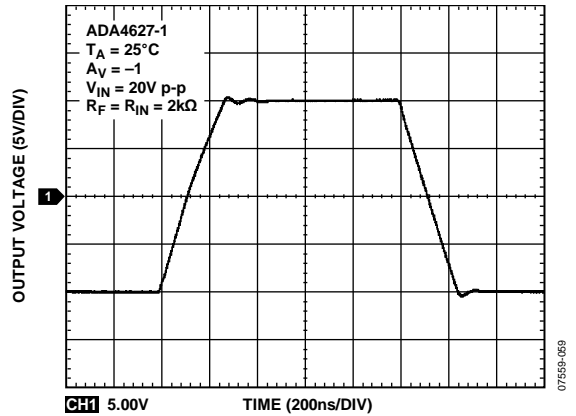

Figure 27. Large Signal Transient Response

# ADA4627-1/ADA4637-1

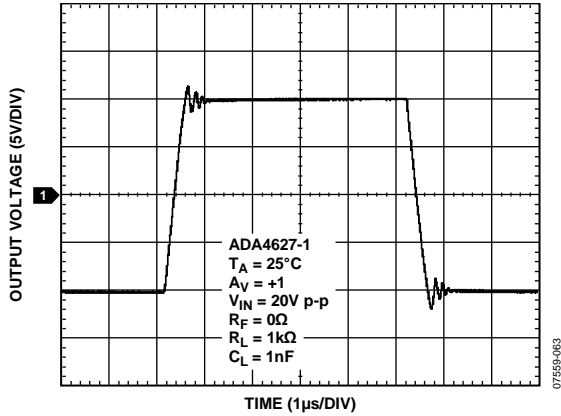

Figure 28. Large Signal Transient Response

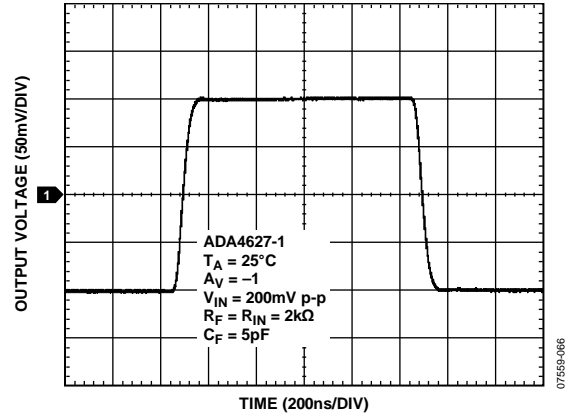

Figure 31. Small Signal Transient Response

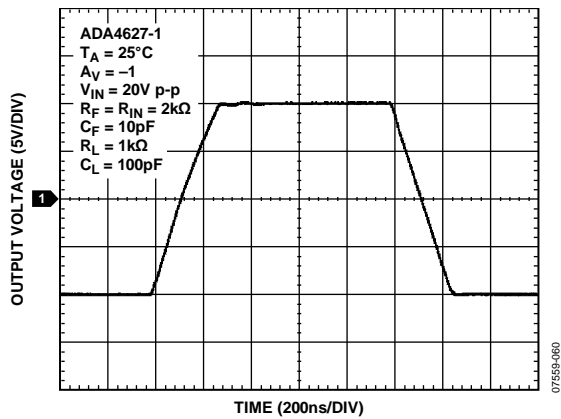

Figure 29. Large Signal Transient Response

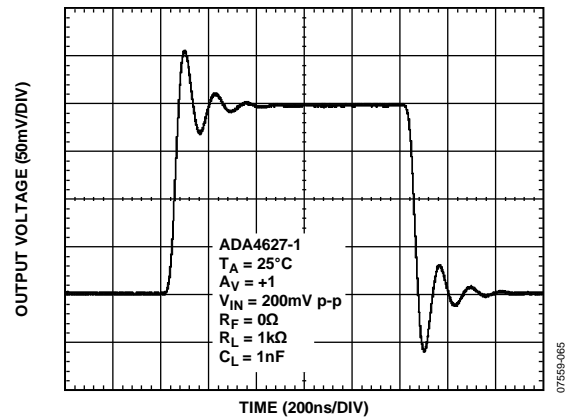

Figure 32. Small Signal Transient Response

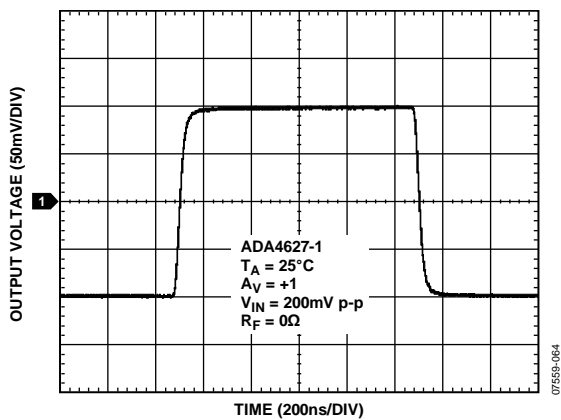

Figure 30. Small Signal Transient Response

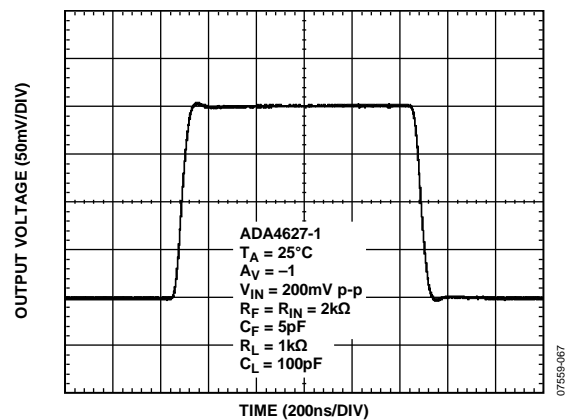

Figure 33. Small Signal Transient Response

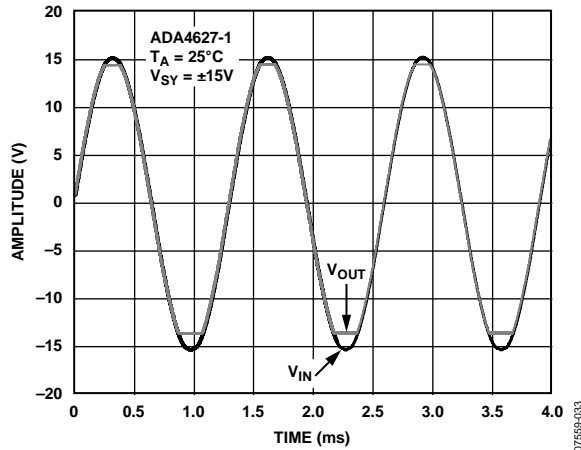

Figure 34. No Phase Reversal

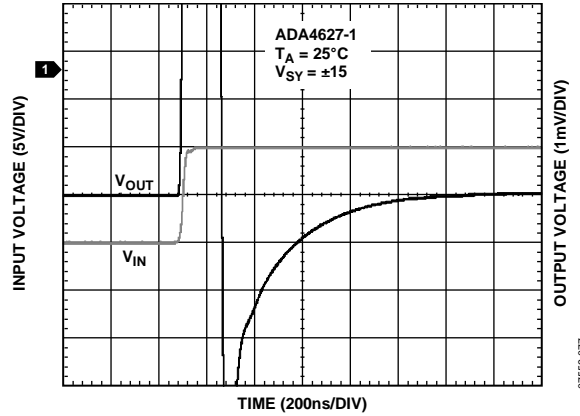

Figure 37. Positive Settling Time to 0.01%

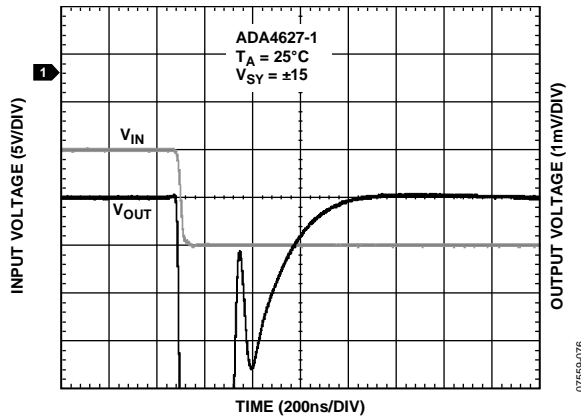

Figure 35. Negative Settling Time to 0.01%

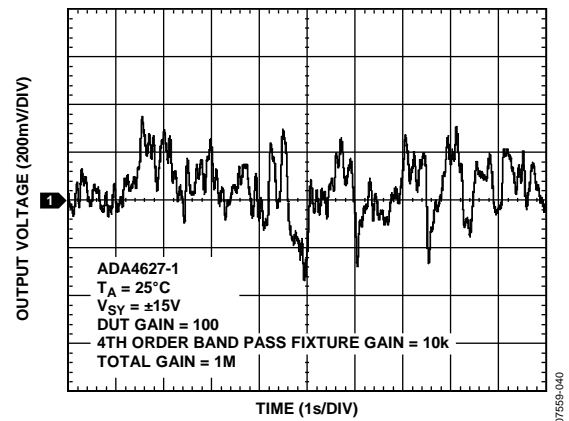

Figure 38. 0.1 Hz to 10 Hz Noise

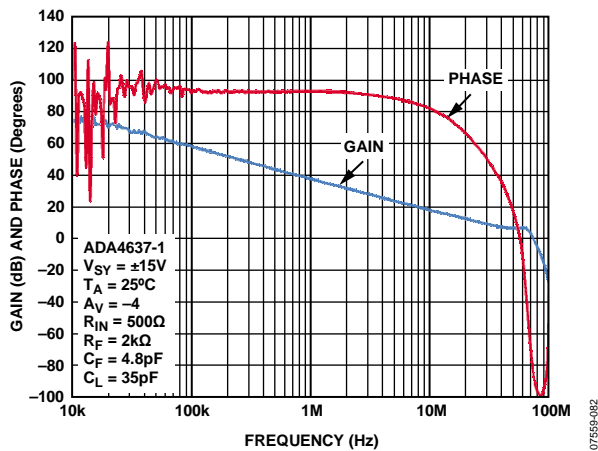

Figure 36. Open-Loop Gain and Phase vs. Frequency

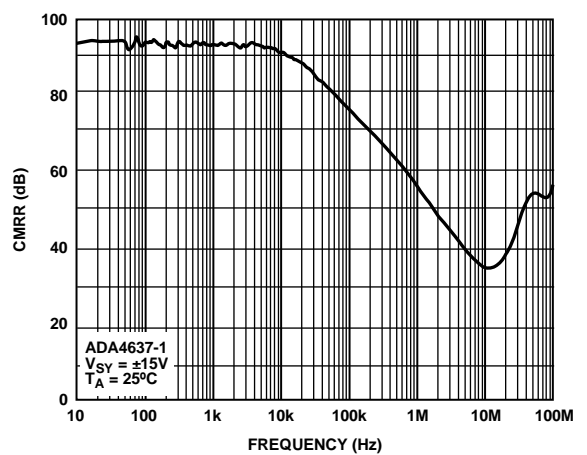

Figure 39. CMRR vs. Frequency

# ADA4627-1/ADA4637-1

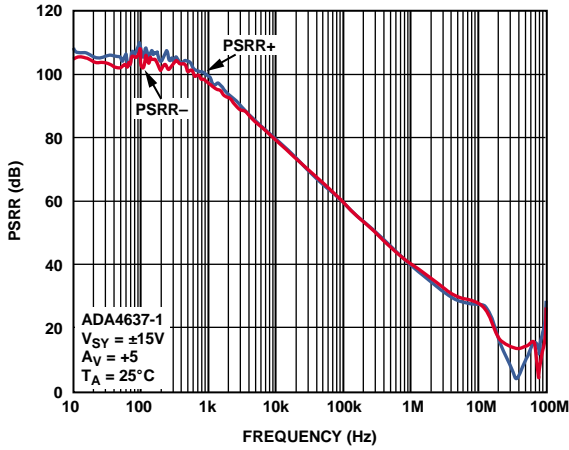

Figure 40. PSRR vs. Frequency

07559-081

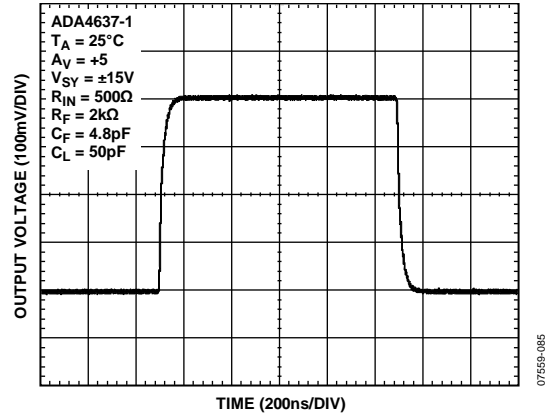

Figure 43. Small Signal Transient Response

07559-085

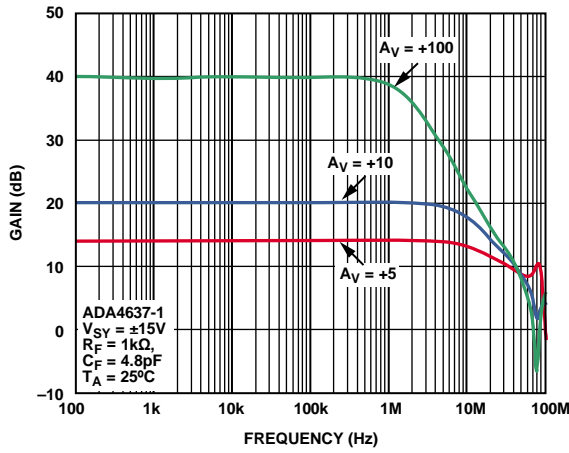

Figure 41. Closed-Loop Gain vs. Frequency

07559-079

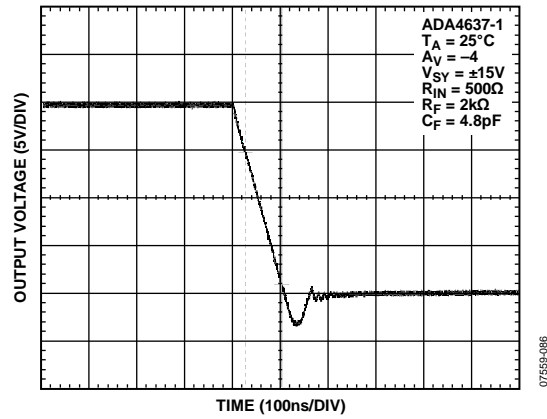

Figure 44. Slew Rate Falling

07559-086

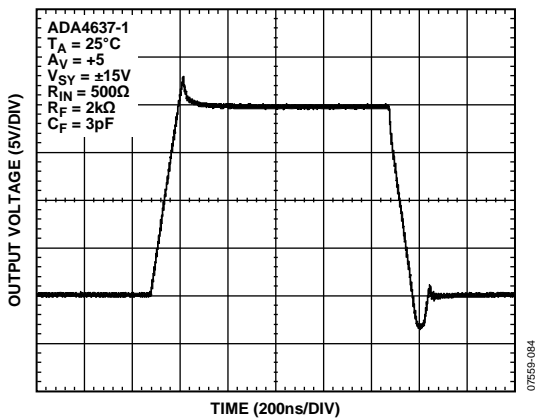

Figure 42. Large Signal Transient Response

07559-084

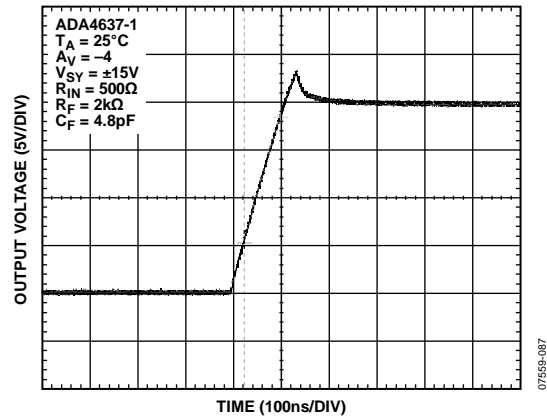

Figure 45. Slew Rate Rising

07559-087

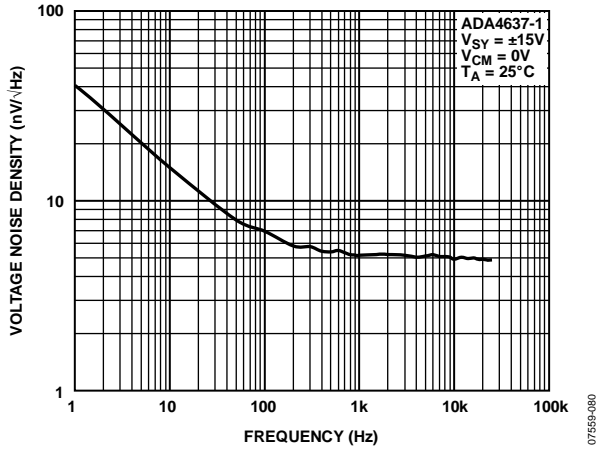

Figure 46. Voltage Noise Density vs. Frequency

## THEORY OF OPERATION

The ADA4627-1 is a high speed, unity gain stable amplifier with excellent dc characteristics. The ADA4637-1 is a decompensated version that is stable at a gain of 5 or greater. The typical offset voltage of 70  $\mu\text{V}$  allows the amplifiers to be easily configured for high gains without the risk of excessive output voltage errors. The small temperature drift of 2  $\mu\text{V}/^\circ\text{C}$  ensures a minimum offset voltage error over the entire temperature range of  $-40^\circ\text{C}$  to  $+125^\circ\text{C}$ , making the amplifiers ideal for a variety of sensitive measurement applications in harsh operating environments.

### INPUT VOLTAGE RANGE

The ADA4627-1/ADA4637-1 are not rail-to-rail input amplifiers; therefore, care is required to ensure that both inputs do not exceed the input voltage range. Under normal negative feedback operating conditions, the amplifier corrects its output to ensure that the two inputs are at the same voltage. However, if either input exceeds the input voltage range, the loop opens, and large currents begin to flow through the ESD protection diodes in the amplifier.

These diodes are connected between the inputs and each supply rail to protect the input transistors against an electrostatic discharge event, and they are normally reverse-biased. However, if the input voltage exceeds the supply voltage, these ESD diodes can become forward-biased. Without current limiting, excessive amounts of current can flow through these diodes, causing permanent damage to the device. If inputs are subject to overvoltage, insert appropriate series resistors to limit the diode current to less than 5 mA.

### INPUT OFFSET VOLTAGE ADJUST RANGE

The ADA4627-1/ADA4637-1 SOIC packages have offset adjust pins for compatibility with some existing designs. The recommended offset nulling circuit is shown in Figure 47.

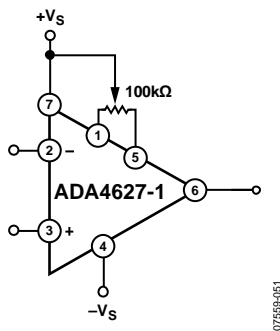

Figure 47. Standard Offset Null Circuit

With a 100 k $\Omega$  potentiometer, the adjustment range is more than  $\pm 11$  mV. However, the  $V_{OS}$  temperature drift increases by several  $\mu\text{V}/^\circ\text{C}$  for every millivolt of offset adjust. The ADA4627-1/ADA4637-1 have matching thin film resistors that are laser trimmed at two temperatures to minimize both offset voltage and offset voltage drift. The offset voltage at room temperature is less than 0.5 mV, and the offset voltage drift is only a few  $\mu\text{V}/^\circ\text{C}$  or less; therefore, it is not recommended to

use the offset adjust pins, especially for offset adjust of a complete signal chain. Signal chain offset can be addressed with an auto-zero amplifier used to form a composite amplifier; or, if the ADA4627-1 or the ADA4637-1 is in an inverting amplifier stage, it can be modified easily to add a potentiometer (see Figure 48). The LFCSP package does not have offset adjust pins.

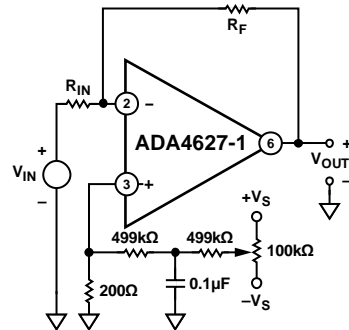

Figure 48. Alternate Offset Null Circuit for Inverting Stage

### INPUT BIAS CURRENT

Because the ADA4627-1/ADA4637-1 have a JFET input stage, the input bias current, due to the reverse-biased junction, has a leakage current that approximately doubles every  $10^\circ\text{C}$ . The power dissipation of the part, combined with the thermal resistance of the package, results in the junction temperature increasing up to 20 degrees to 30 degrees Celsius above ambient. This parameter is tested with high speed ATE equipment, which does not result in the die temperature reaching equilibrium. This is correlated with bench measurements to match the guaranteed maximum at room temperature shown in Table 2.

The input current can be reduced by keeping the temperature as low as possible and using a light load on the output.

### NOISE CONSIDERATIONS

The JFET input stage offers very low input voltage noise and input current noise. The thermal noise of a 1 k $\Omega$  resistor at room temperature is 4 nV/ $\sqrt{\text{Hz}}$ ; therefore, low values of resistance should be used for dc-coupled inverting and noninverting amplifier configurations. In the case of transimpedance amplifiers (TIAs), current noise is more important.

The ADA4627-1/ADA4637-1 are an excellent choice for both of these applications. Analog Devices offers a wide variety of low voltage noise and low current noise op amps in a variety of processes that are optimized for different supply voltage ranges. Refer to Application Note AN-940 for a discussion of noise, calculations, and selection tables for more than three dozen low noise, op amp families.

**THD + N MEASUREMENTS**

Total harmonic distortion plus noise (THD + N) is usually measured with an audio analyzer, such as those from Audio Precision, Inc™. The analyzer consists of a low distortion oscillator that is swept from the starting frequency to the ending frequency. The oscillator is connected to the circuit under test, and the output of the circuit goes back to the analyzer.

The analyzer has a tunable notch filter in lock step with the swept oscillator. This removes the fundamental frequency but allows all of the harmonics and wideband noise to be measured with an integrating voltmeter. However, there is a switchable low-pass filter in series with the notch filter. If the sine wave is at 100 Hz, then the tenth harmonic is still at 1 kHz; therefore, having a low pass at 80 kHz is not a problem. When the oscillator reaches 20 kHz, the fourth harmonic (80 kHz) is partially attenuated, resulting in a lower reading from the voltmeter. When evaluating THD + N curves from any manufacturer, careful attention should be paid to the test conditions. The difference between an 80 kHz low-pass filter and a 500 kHz filter is shown in Figure 49.

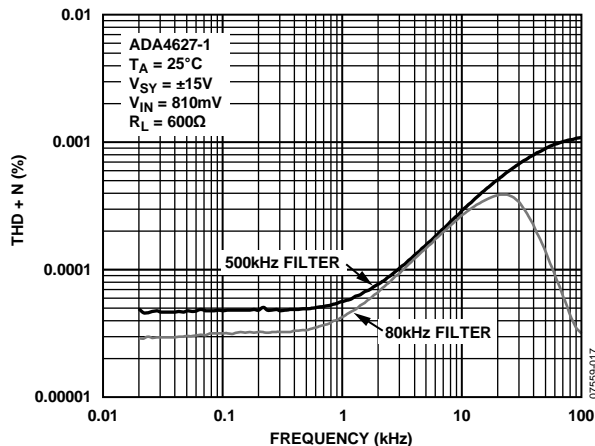

Figure 49. THD + N vs. Frequency

**PRINTED CIRCUIT BOARD LAYOUT, BIAS CURRENT, AND BYPASSING**

To take advantage of the very low input bias current of the ADA4627-1/ADA4637-1 at room temperature, leakage paths must be considered. A printed circuit board (PCB), with dust and humidity, can have 100 MΩ of resistance over a few tenths of an inch. A 1 mV differential between the two points results in 10 pA of leakage current, more than the guaranteed maximum.

The op amp inputs should be guarded by surrounding the nets with a metal trace maintained at the predicted voltage. In the case of an inverting configuration or transimpedance amplifier, (see Figure 50), the inverting and noninverting nodes can be surrounded by traces held at a quiet analog ground.

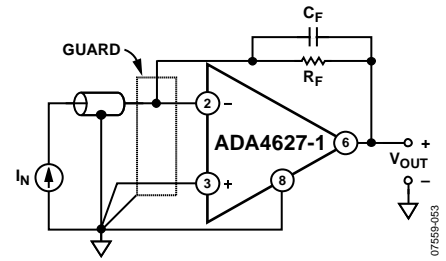

Figure 50. Inverting Amplifier with Guard

For a noninverting configuration, the trace can be driven from the feedback divider, but the resistors should be chosen to offer a low impedance drive to the trace (see Figure 51).

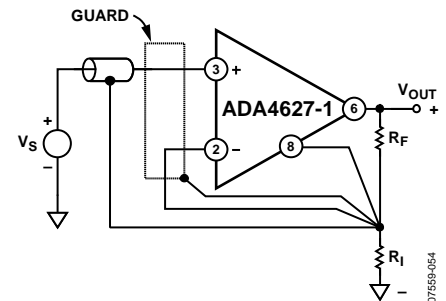

Figure 51. Noninverting Amplifier with Guard

The board layout should be compact with traces as short as possible. For second-order board considerations, such as triboelectric effects and piezoelectric effects, as well as a table of insulating material properties, see the AD549 data sheet.

In some cases, shielding from air currents may be helpful. A general rule of thumb, for op amps with gain bandwidth products higher than 1 MHz, bypass capacitors should be very close to the part, within 3 mm. Each supply should be bypassed with a 0.01 μF ceramic capacitor in parallel with a 1 μF bulk decoupling capacitor. The ceramic capacitors should be closer to the op amp. Sockets, which add inductance and capacitance, should not be used.

**OUTPUT PHASE REVERSAL**

Output phase reversal occurs in some amplifiers when the input common-mode voltage range is exceeded. As common-mode voltage is moved outside the common-mode range, the outputs of these amplifiers can suddenly jump in the opposite direction to the supply rail. This is the result of the differential input pair shutting down, causing a radical shifting of internal voltages that results in the erratic output behavior.

The ADA4627-1/ADA4637-1 amplifiers have been carefully designed to prevent any output phase reversal if both inputs are maintained within the specified input voltage range. If one or both inputs exceed the input voltage range but remain within the supply rails, an internal loop opens and the output varies. Therefore, the inputs should always be a minimum of 3 V away from either supply rail.

## ADA4627-1/ADA4637-1

### DECOMPENSATED OP AMPS

The ADA4637-1 is a decompensated op amp, and, as such, must always be operated at a noise gain of 5 or greater. See tutorial MT-033, “Voltage Feedback Op Amp Gain and Bandwidth”, at [www.analog.com](http://www.analog.com) for more information.

### DRIVING CAPACITIVE LOADS

Adding capacitance to the output of any op amp results in additional phase shift, which reduces stability and leads to overshoot

or oscillation. The ADA4627-1/ADA4637-1 have a high phase margin and low output impedance, so they can drive reasonable values of capacitance. This is a common situation when an amplifier is used to drive the input of switched capacitor ADCs. For other considerations and various circuit solutions, see the Analog Dialogue article titled *Ask the Applications Engineer-25, Op Amps Driving Capacitive Loads*, available at [www.analog.com](http://www.analog.com).



OUTLINE DIMENSIONS

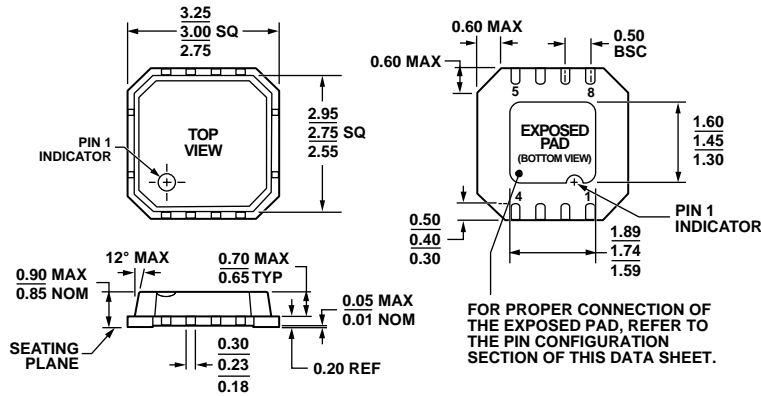
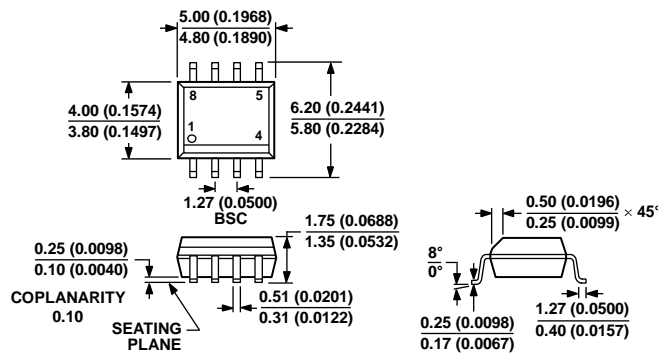

Figure 52. 8-Lead Lead Frame Chip Scale Package [LFCSP\_VD]  
 3 mm x 3 mm Body, Very Thin, Dual Lead  
 (CP-8-2)  
 Dimensions shown in millimeters

090308-B



COMPLIANT TO JEDEC STANDARDS MS-012-A A  
 CONTROLLING DIMENSIONS ARE IN MILLIMETERS; INCH DIMENSIONS  
 (IN PARENTHESES) ARE ROUNDED-OFF MILLIMETER EQUIVALENTS FOR  
 REFERENCE ONLY AND ARE NOT APPROPRIATE FOR USE IN DESIGN.

Figure 53. 8-Lead Standard Small Outline Package [SOIC\_N]  
 Narrow Body  
 (R-8)  
 Dimensions shown in millimeters and (inches)

012407-A

# ADA4627-1/ADA4637-1

## ORDERING GUIDE

| Model <sup>1</sup> | Temperature Range | Package Description | Package Option | Branding |
|--------------------|-------------------|---------------------|----------------|----------|
| ADA4627-1ACPZ-R2   | -40°C to +125°C   | 8-Lead LFCSP_VD     | CP-8-2         | A29      |
| ADA4627-1ACPZ-RL   | -40°C to +125°C   | 8-Lead LFCSP_VD     | CP-8-2         | A29      |
| ADA4627-1ACPZ-R7   | -40°C to +125°C   | 8-Lead LFCSP_VD     | CP-8-2         | A29      |
| ADA4627-1ARZ       | -40°C to +125°C   | 8-Lead SOIC_N       | R-8            |          |
| ADA4627-1ARZ-RL    | -40°C to +125°C   | 8-Lead SOIC_N       | R-8            |          |
| ADA4627-1ARZ-R7    | -40°C to +125°C   | 8-Lead SOIC_N       | R-8            |          |
| ADA4627-1BRZ       | -40°C to +125°C   | 8-Lead SOIC_N       | R-8            |          |
| ADA4627-1BRZ-R7    | -40°C to +125°C   | 8-Lead SOIC_N       | R-8            |          |
| ADA4627-1BRZ-RL    | -40°C to +125°C   | 8-Lead SOIC_N       | R-8            |          |
| ADA4637-1ACPZ-R2   | -40°C to +125°C   | 8-Lead LFCSP_VD     | CP-8-2         | A25      |
| ADA4637-1ACPZ-RL   | -40°C to +125°C   | 8-Lead LFCSP_VD     | CP-8-2         | A25      |
| ADA4637-1ACPZ-R7   | -40°C to +125°C   | 8-Lead LFCSP_VD     | CP-8-2         | A25      |
| ADA4637-1ARZ       | -40°C to +125°C   | 8-Lead SOIC_N       | R-8            |          |
| ADA4637-1ARZ-RL    | -40°C to +125°C   | 8-Lead SOIC_N       | R-8            |          |
| ADA4637-1ARZ-R7    | -40°C to +125°C   | 8-Lead SOIC_N       | R-8            |          |
| ADA4637-1BRZ       | -40°C to +125°C   | 8-Lead SOIC_N       | R-8            |          |
| ADA4637-1BRZ-R7    | -40°C to +125°C   | 8-Lead SOIC_N       | R-8            |          |
| ADA4637-1BRZ-RL    | -40°C to +125°C   | 8-Lead SOIC_N       | R-8            |          |

<sup>1</sup> Z = RoHS Compliant Part.

**NOTES**

**NOTES**

## Данный компонент на территории Российской Федерации

### Вы можете приобрести в компании MosChip.

Для оперативного оформления запроса Вам необходимо перейти по данной ссылке:

<http://moschip.ru/get-element>

Вы можете разместить у нас заказ для любого Вашего проекта, будь то серийное производство или разработка единичного прибора.

В нашем ассортименте представлены ведущие мировые производители активных и пассивных электронных компонентов.

Нашей специализацией является поставка электронной компонентной базы двойного назначения, продукции таких производителей как XILINX, Intel (ex.ALTERA), Vicor, Microchip, Texas Instruments, Analog Devices, Mini-Circuits, Amphenol, Glenair.

Сотрудничество с глобальными дистрибьюторами электронных компонентов, предоставляет возможность заказывать и получать с международных складов практически любой перечень компонентов в оптимальные для Вас сроки.

На всех этапах разработки и производства наши партнеры могут получить квалифицированную поддержку опытных инженеров.

Система менеджмента качества компании отвечает требованиям в соответствии с ГОСТ Р ИСО 9001, ГОСТ РВ 0015-002 и ЭС РД 009

### Офис по работе с юридическими лицами:

105318, г.Москва, ул.Щербаковская д.3, офис 1107, 1118, ДЦ «Щербаковский»

Телефон: +7 495 668-12-70 (многоканальный)

Факс: +7 495 668-12-70 (доб.304)

E-mail: [info@moschip.ru](mailto:info@moschip.ru)

Skype отдела продаж:

moschip.ru

moschip.ru\_4

moschip.ru\_6

moschip.ru\_9