



00-9175-00X-701-XX6

PREFIX

SERIES

NO. OF WAYS

CODE	NO. OF WAYS
002	2
003	3

Elco Europe (A Division of AVX Ltd) CONFIDENTIAL PROPRIETARY  
The document on this print and information therewith are PROPRIETY  
to Elco Europe (A Division of AVX Ltd) and shall not be copied  
or disclosed in whole or in part without Elco Europe's written consent.

WIRE GAUGE SIZE

CODE	DESCRIPTION	ACCEPTED WIRE GAUGE	WIRE INSULATION
701	CAP PRE-ASSEMBLED	28 GAUGE SOLID OR STRANDED 26 GAUGE SOLID OR STRANDED	MIN Ø0.70 MAX Ø1.00

INSULATION COLOUR

CODE	INSULATION COLOUR	AVAILABILITY
0	BLACK	SPECIAL ORDER
1	WHITE	STANDARD

CAP OPTIONS

CODE	CAP OPTION	DESCRIPTION	SHEET
0	THROUGH WIRE	ALLOWS WIRE TO BE TERMINATED AT ANY POINT	2&3
9	WIRE STOP	TERMINATES END OF WIRE END PROTECTED BY STOP FACE	4&5

PLATING OPTION

CODE	DESCRIPTION
6	PURE TIN OVER ALL OVER



ELCO EUROPE (A DIVISION OF AVX LTD.) CONFIDENTIAL PROPRIETARY  
THE DRAWING ON THIS PRINT AND INFORMATION THEREWITH ARE  
PROPRIETARY TO ELCO EUROPE (A DIVISION OF AVX LTD.) AND  
SHALL NOT BE USED OR DISCLOSED IN WHOLE OR IN PART  
WITHOUT ELCO EUROPE'S WRITTEN CONSENT.

SHEET 1 OF 6

Release No.  
History  
102869  
04.05.2012  
22.05.2012

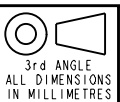

**ELCO**  
© COPYRIGHT ELCO EUROPE  
NOT TO BE DISCLOSED OR COPIED  
WITHOUT WRITTEN PERMISSION

Drawn N.C.H.	Description 26-28AWG IDC WIRE TO BOARD CONNECTOR	DATE 04-Apr-12
Size CV	Part Number 00-9175-01_700S	Issue B

FORM-106-01-036-6 ISS 7

**26-28 AWG 2 WAY IDC CONNECTOR  
THROUGH WIRE CAPPED IDC**

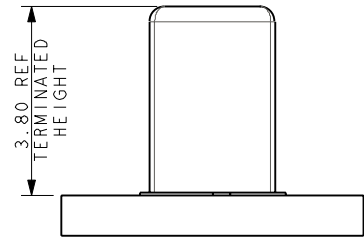
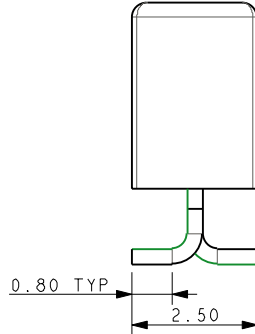
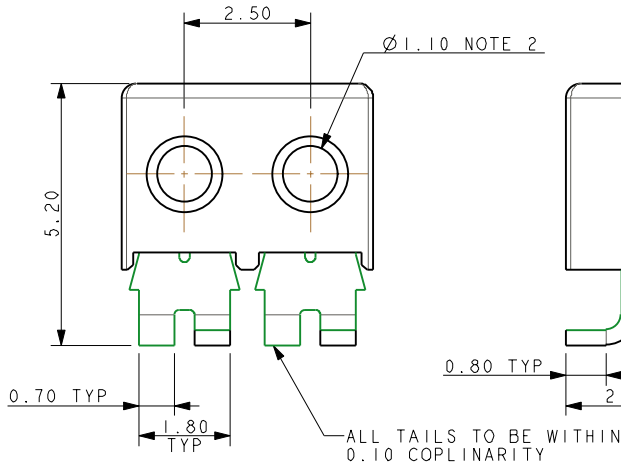
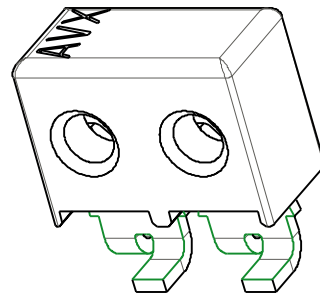
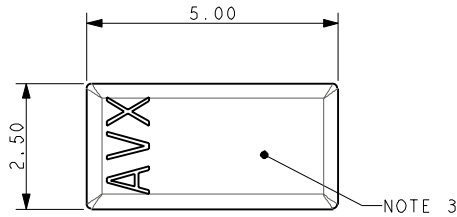

**MOUNTED ON PCB**

**Elco Europe (A Division of AVX Ltd) CONFIDENTIAL PROPRIETY**  
The document on this print and information therewith are PROPRIETY to Elco Europe (A Division of AVX Ltd) and shall not be copied or disclosed in whole or in part without Elco Europe's written consent.

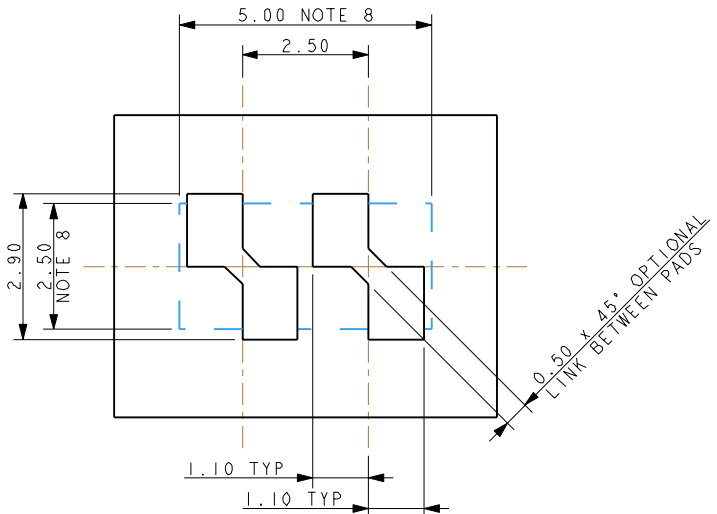
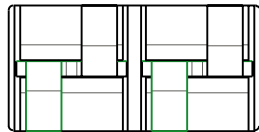

**SUGGESTED PCB LAYOUT**

**PACKING DETAILS**

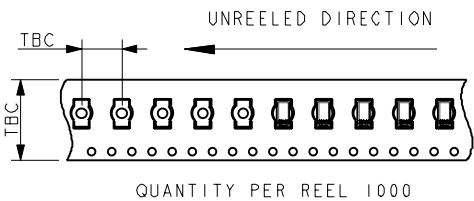
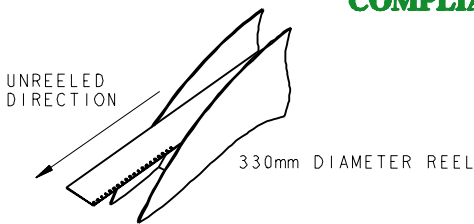

**NOTES :-**

- 2 WAY CONNECTOR FOR IDC WIRE TO BOARD CONNECTION, PRE-ASSEMBLED THROUGH WIRE CAP.
- CONTACT/CAP TO MATCH 26AWG AND 28AWG WIRES, SOLID OR STANDED CONDUCTOR, MAXIMUM INSULATOR 1.00mm DIAMETER.
- FLAT FACE ON TOP OF CAP TO AID PICK AND PLACE ASSEMBLY.
- FOR FULL DETAILS REFER TO ELCO SPECIFICATION 201-01-139.
- ASSEMBLY PROCEDURE, REFER TO APPLICATION NOTES 201-01-140.
- GENERAL TOLERANCE  $\pm 0.20$  UNLESS STATED.
- PACKED IN TAPE AND REEL, QUANTITY PER REEL 1000.
- CONNECTOR OUTLINE.
- CONTACT MATERIAL :- TIN PLATED COPPER ALLOY.
- INSULATOR MATERIAL :- HIGH TEMPERATURE NYLON, GLASS FILLED, UL94 V-0, COLOUR REFER TO SHEET 1.

ELCO EUROPE (A DIVISION OF AVX LTD.) CONFIDENTIAL PROPRIETY  
THE DRAWING ON THIS PRINT AND INFORMATION THEREWITH ARE PROPRIETY TO ELCO EUROPE (A DIVISION OF AVX LTD.) AND SHALL NOT BE USED OR DISCLOSED IN WHOLE OR IN PART WITHOUT ELCO EUROPE'S WRITTEN CONSENT.

SHEET 2 OF 6

Release No. 102869  
History 04.05.2012  
22.05.2012

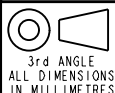

**ELCO**  
© COPYRIGHT ELCO EUROPE  
NOT TO BE DISCLOSED OR COPIED  
WITHOUT WRITTEN PERMISSION

Drawn N.C.H.	Description 26-28AWG IDC WIRE TO BOARD CONNECTOR	DATE 03-Apr-12
Size CV	Part Number 00-9175-01_700S	Issue B

A

B

**26-28 AWG 3 WAY IDC CONNECTOR  
THROUGH WIRE CAPPED IDC**

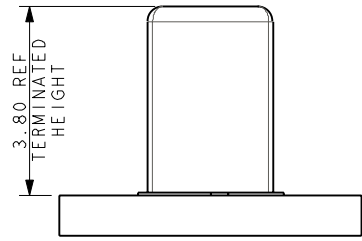
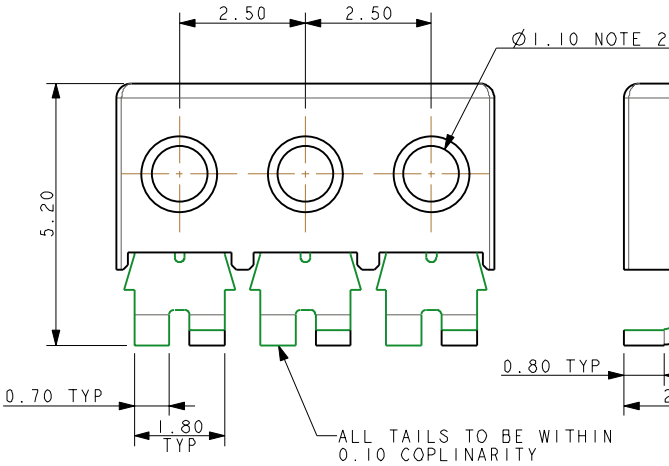
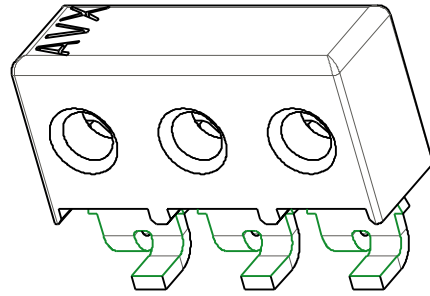
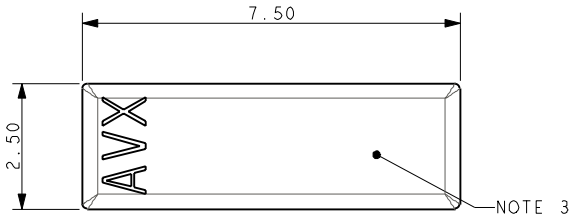

**MOUNTED ON PCB**

Elco Europe (A Division of AVX Ltd) CONFIDENTIAL PROPRIETY  
The document on this print and information therewith are PROPRIETY  
to Elco Europe (A Division of AVX Ltd) and shall not be copied  
or disclosed in whole or in part without Elco Europe's written consent.

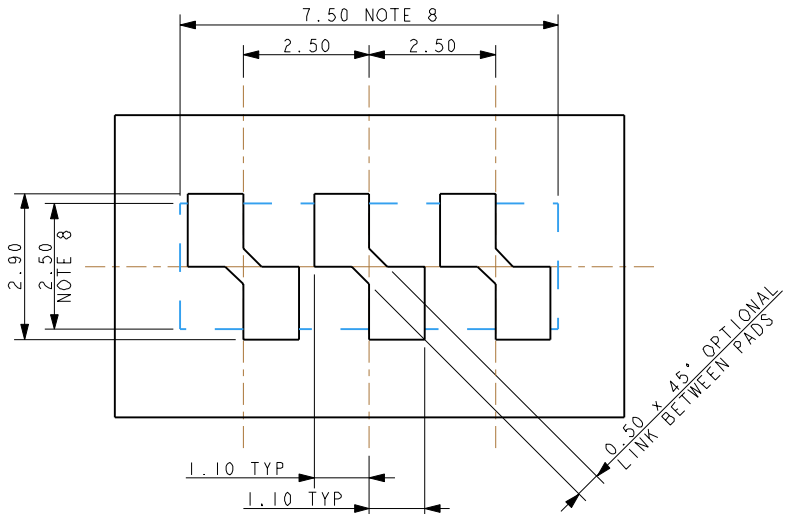
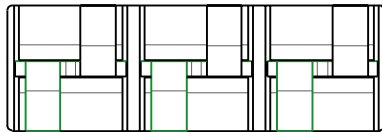

**SUGGESTED PCB LAYOUT**

**PACKING DETAILS**

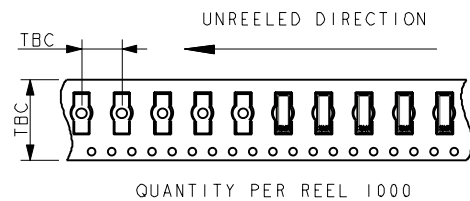
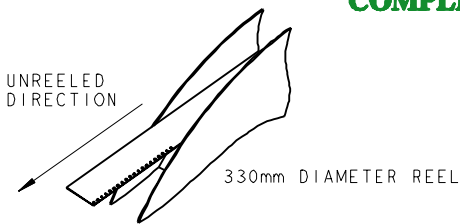

**NOTES :-**

1. 3 WAY CONNECTOR FOR IDC WIRE TO BOARD CONNECTION, PRE-ASSEMBLED THROUGH WIRE CAP.
2. CONTACT/CAP TO MATCH 26AWG AND 28AWG WIRES, SOLID OR STANDED CONDUCTOR, MAXIMUM INSULATOR 1.00mm DIAMETER.
3. FLAT FACE ON TOP OF CAP TO AID PICK AND PLACE ASSEMBLY.
4. FOR FULL DETAILS REFER TO ELCO SPECIFICATION 201-01-139.
5. ASSEMBLY PROCEDURE, REFER TO APPLICATION NOTES 201-01-140.
6. GENERAL TOLERANCE  $\pm 0.20$  UNLESS STATED.
7. PACKED IN TAPE AND REEL, QUANTITY PER REEL 1000.
8. CONNECTOR OUTLINE.
9. CONTACT MATERIAL :- TIN PLATED COPPER ALLOY.
10. INSULATOR MATERIAL :- HIGH TEMPERATURE NYLON, GLASS FILLED, UL94 V-0, COLOUR REFER TO SHEET 1.

ELCO EUROPE (A DIVISION OF AVX LTD.) CONFIDENTIAL PROPRIETY  
THE DRAWING ON THIS PRINT AND INFORMATION THEREWITH ARE  
PROPRIETARY TO ELCO EUROPE (A DIVISION OF AVX LTD.) AND  
SHALL NOT BE USED OR DISCLOSED IN WHOLE OR IN PART  
WITHOUT ELCO EUROPE'S WRITTEN CONSENT.

SHEET 3 OF 6

FORM-106-01-056-6 ISS 7

Release No.  
History  
102869  
04.05.2012  
22.05.2012

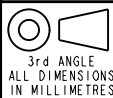

**ELCO**  
© COPYRIGHT ELCO EUROPE  
NOT TO BE DISCLOSED OR COPIED  
WITHOUT WRITTEN PERMISSION

Drawn  
N.C.H.  
Size  
CV

Description  
26-28AWG IDC WIRE TO BOARD CONNECTOR  
Part Number  
00-9175-01\_700S

DATE  
03-Apr-12  
Issue  
B

A

B

**26-28 AWG 2 WAY IDC CONNECTOR  
WIRE STOP CAPPED IDC**

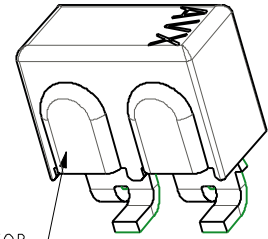
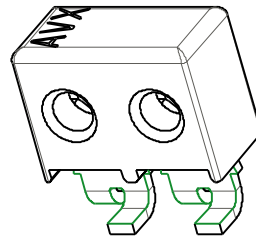
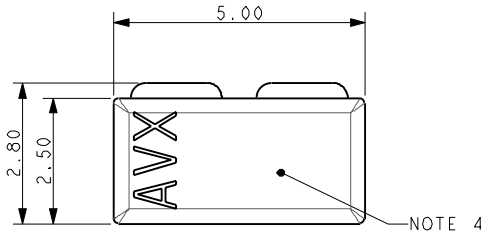

WIRE STOP  
NOTE 2

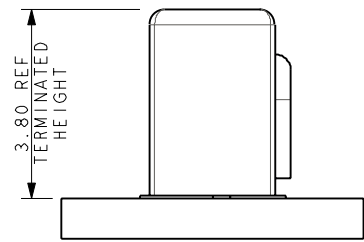
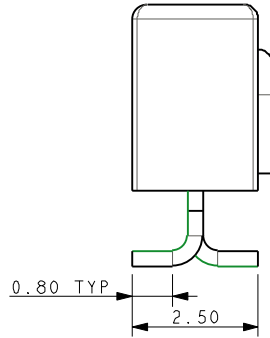
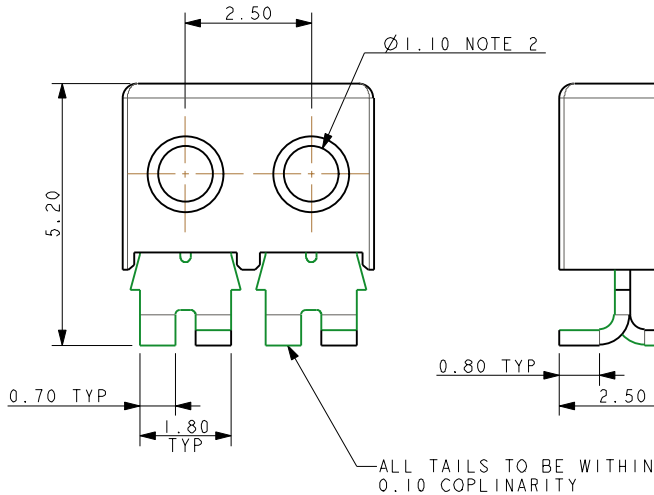

**MOUNTED ON PCB**

Elco Europe (A Division of AVX Ltd) CONFIDENTIAL PROPRIETY  
The document on this print and information therewith are PROPRIETY  
to Elco Europe (A Division of AVX Ltd) and shall not be copied  
or disclosed in whole or in part without Elco Europe's written consent.

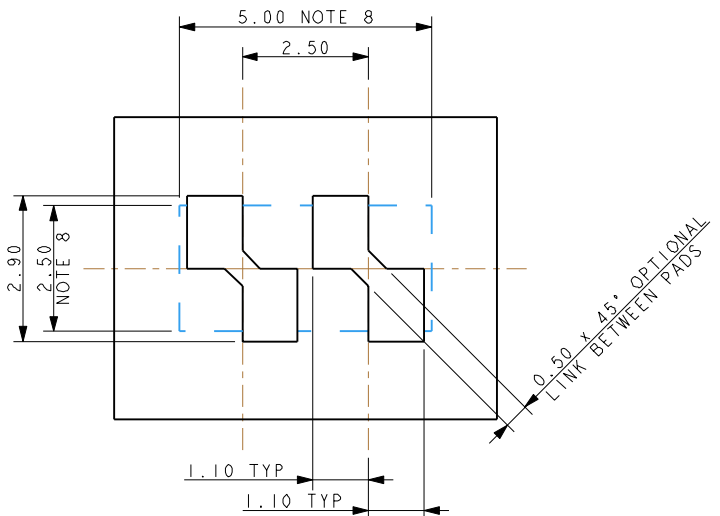
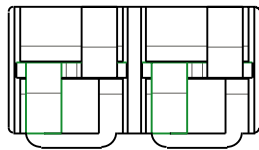

**SUGGESTED PCB LAYOUT**

**PACKING DETAILS**



**RoHS  
COMPLIANT**

UNREELED  
DIRECTION

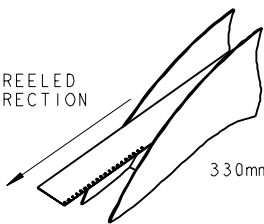

330mm DIAMETER REEL

UNREELED DIRECTION

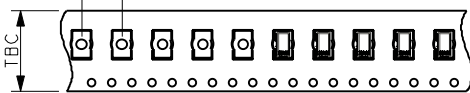

QUANTITY PER REEL 1000

**NOTES :-**

1. 2 WAY CONNECTOR FOR IDC WIRE TO BOARD CONNECTION, PRE-ASSEMBLED WIRE STOP CAP.
2. WIRE STOP CAP PROTECTS END OF WIRE.
3. CONTACT/CAP TO MATCH 26AWG AND 28AWG WIRES, SOLID OR STANDED CONDUCTOR, MAXIMUM INSULATOR 1.00mm DIAMETER.
4. FLAT FACE ON TOP OF CAP TO AID PICK AND PLACE ASSEMBLY.
5. FOR FULL DETAILS REFER TO ELCO SPECIFICATION 201-01-139.
6. ASSEMBLY PROCEDURE, REFER TO APPLICATION NOTES 201-01-140.
7. GENERAL TOLERANCE  $\pm 0.20$  UNLESS STATED.
8. PACKED IN TAPE AND REEL, QUANTITY PER REEL 1000.
9. CONNECTOR OUTLINE.
10. CONTACT MATERIAL :- TIN PLATED COPPER ALLOY.
11. INSULATOR MATERIAL :- HIGH TEMPERATURE NYLON, GLASS FILLED, UL94 V-0, COLOUR REFER TO SHEET 1.

ELCO EUROPE (A DIVISION OF AVX LTD.) CONFIDENTIAL PROPRIETY  
THE DRAWING ON THIS PRINT AND INFORMATION THEREWITH ARE  
PROPRIETARY TO ELCO EUROPE (A DIVISION OF AVX LTD.) AND  
SHALL NOT BE USED OR DISCLOSED IN WHOLE OR IN PART  
WITHOUT ELCO EUROPE'S WRITTEN CONSENT.

SHEET 4 OF 6

Release No.  
History  
102869  
04.05.2012  
22.05.2012

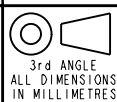

**ELCO**  
© COPYRIGHT ELCO EUROPE  
NOT TO BE DISCLOSED OR COPIED  
WITHOUT WRITTEN PERMISSION

Drawn N.C.H.	Description 26-28AWG IDC WIRE TO BOARD CONNECTOR	DATE 03-Apr-12
Size CV	Part Number 00-9175-01_700S	Issue B

A

B

**26-28 AWG 3 WAY IDC CONNECTOR  
WIRE STOP CAPPED IDC**

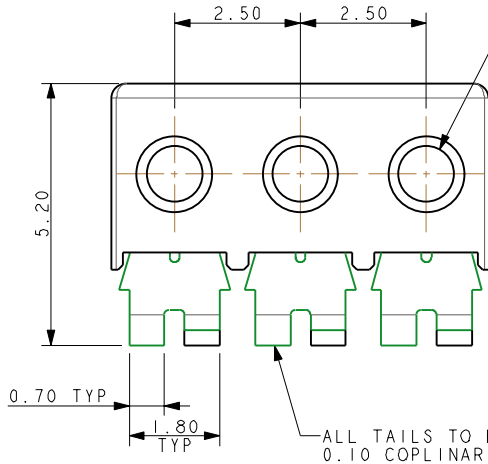
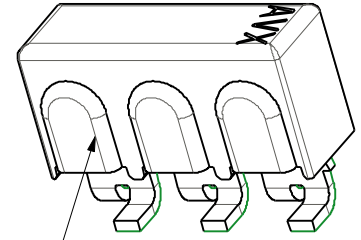
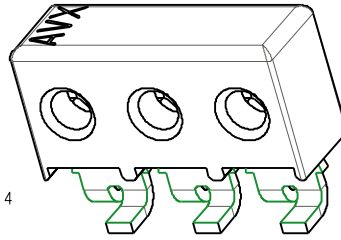
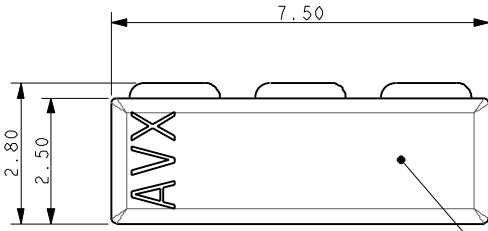

NOTE 4

WIRE STOP NOTE 2

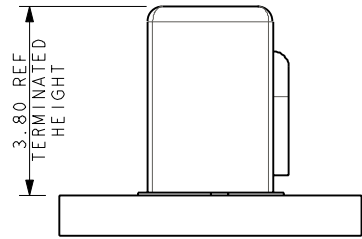
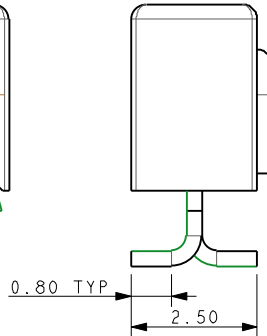

**MOUNTED ON PCB**

Elco Europe (A Division of AVX Ltd) CONFIDENTIAL PROPRIETY  
The document on this print and information therewith are PROPRIETY to Elco Europe (A Division of AVX Ltd) and shall not be copied or disclosed in whole or in part without Elco Europe's written consent.

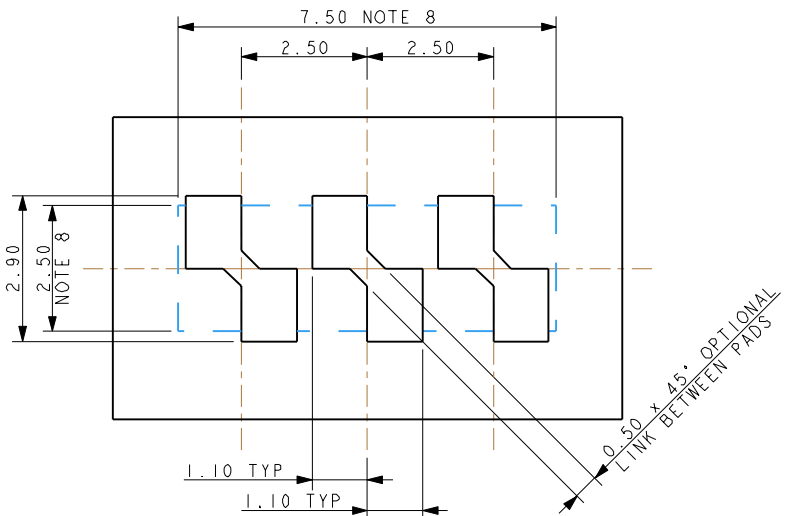
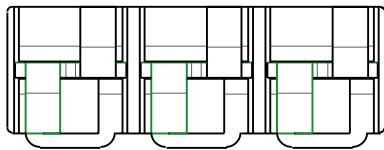

**SUGGESTED PCB LAYOUT**

**PACKING DETAILS**

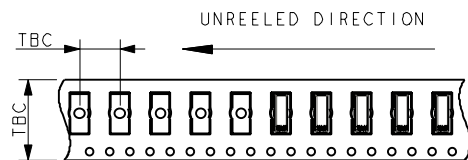
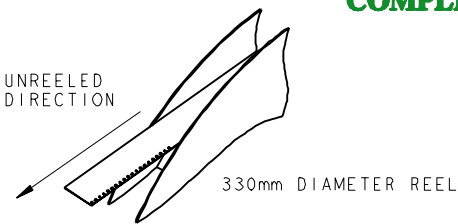

QUANTITY PER REEL 1000

**NOTES :-**

1. 3 WAY CONNECTOR FOR IDC WIRE TO BOARD CONNECTION, PRE-ASSEMBLED WIRE STOP CAP.
2. WIRE STOP PROTECTS END OF WIRE.
3. CONTACT/CAP TO MATCH 26AWG AND 28AWG WIRES, SOLID OR STANDED CONDUCTOR, MAXIMUM INSULATOR 1.00mm DIAMETER.
4. FLAT FACE ON TOP OF CAP TO AID PICK AND PLACE ASSEMBLY.
5. FOR FULL DETAILS REFER TO ELCO SPECIFICATION 201-01-139.
6. ASSEMBLY PROCEDURE, REFER TO APPLICATION NOTES 201-01-140.
7. GENERAL TOLERANCE  $\pm 0.20$  UNLESS STATED.
8. PACKED IN TAPE AND REEL, QUANTITY PER REEL 1000.
9. CONNECTOR OUTLINE.
10. CONTACT MATERIAL :- TIN PLATED COPPER ALLOY.
11. INSULATOR MATERIAL :- HIGH TEMPERATURE NYLON, GLASS FILLED, UL94 V-0, COLOUR REFER TO SHEET 1.

ELCO EUROPE (A DIVISION OF AVX LTD.) CONFIDENTIAL PROPRIETARY  
THE DRAWING ON THIS PRINT AND INFORMATION THEREWITH ARE PROPRIETARY TO ELCO EUROPE (A DIVISION OF AVX LTD.) AND SHALL NOT BE USED OR DISCLOSED IN WHOLE OR IN PART WITHOUT ELCO EUROPE'S WRITTEN CONSENT.

SHEET 5 OF 6

Release No.  
History  
102869  
04.05.2012  
22.05.2012

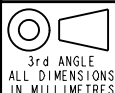

**ELCO**  
© COPYRIGHT ELCO EUROPE  
NOT TO BE DISCLOSED OR COPIED  
WITHOUT WRITTEN PERMISSION

Drawn N.C.H.	Description 26-28AWG IDC WIRE TO BOARD CONNECTOR	DATE 03-Apr-12
Size CV	Part Number 00-9175-01_700S	Issue B

A

B

A

B

### 26-28 AWG ASSEMBLED CAPPED IDC CONNECTORS



Elco Europe (A Division of AVX Ltd) CONFIDENTIAL PROPRIETY  
 The document on this print and information therewith are PROPRIETY  
 to Elco Europe (A Division of AVX Ltd) and shall not be copied  
 or disclosed in whole or in part without Elco Europe's written consent.

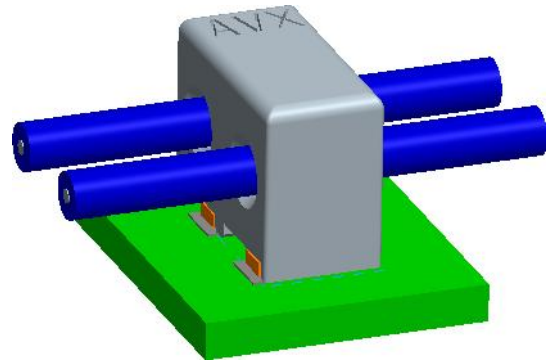
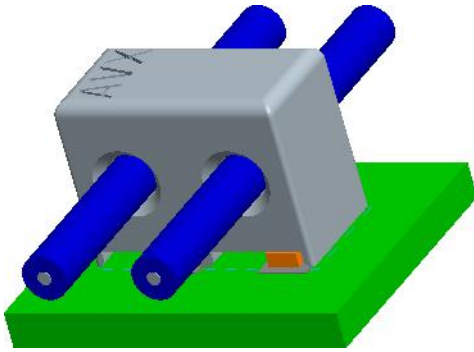

TYPICAL THROUGH WIRE ASSEMBLY

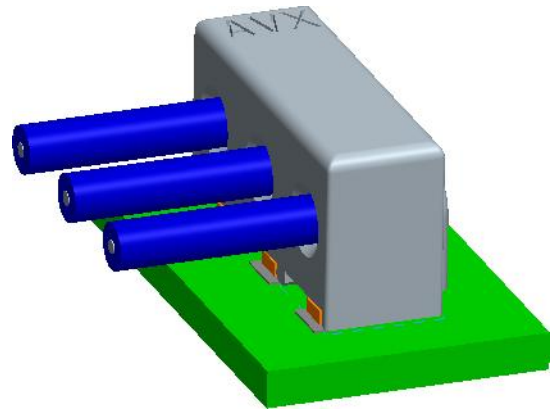
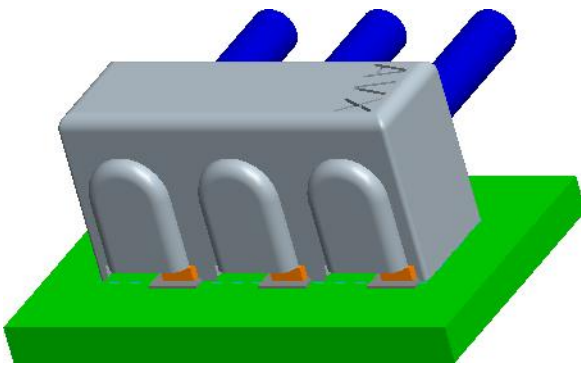

TYPICAL WIRE STOP ASSEMBLY

FORM-106-01-036-6 ISS 7

ELCO EUROPE (A DIVISION OF AVX LTD.) CONFIDENTIAL PROPRIETY  
 THE DRAWING ON THIS PRINT AND INFORMATION THEREWITH ARE  
 PROPRIETARY TO ELCO EUROPE (A DIVISION OF AVX LTD.) AND  
 SHALL NOT BE USED OR DISCLOSED IN WHOLE OR IN PART  
 WITHOUT ELCO EUROPE'S WRITTEN CONSENT.

SHEET 6 OF 6

Release No.  
 History  
 102869  
 04.05.2012  
 22.05.2012

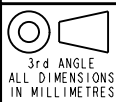

**ELCO**  
 © COPYRIGHT ELCO EUROPE  
 NOT TO BE DISCLOSED OR COPIED  
 WITHOUT WRITTEN PERMISSION

Drawn  
 N.C.H.  
 Size  
 CV

Description  
 26-28AWG IDC WIRE TO BOARD CONNECTOR  
 Part Number  
 00-9175-01\_700S

DATE  
 03-Apr-12  
 Issue  
 B

A

B

## Данный компонент на территории Российской Федерации

### Вы можете приобрести в компании MosChip.

Для оперативного оформления запроса Вам необходимо перейти по данной ссылке:

<http://moschip.ru/get-element>

Вы можете разместить у нас заказ для любого Вашего проекта, будь то серийное производство или разработка единичного прибора.

В нашем ассортименте представлены ведущие мировые производители активных и пассивных электронных компонентов.

Нашей специализацией является поставка электронной компонентной базы двойного назначения, продукции таких производителей как XILINX, Intel (ex.ALTERA), Vicor, Microchip, Texas Instruments, Analog Devices, Mini-Circuits, Amphenol, Glenair.

Сотрудничество с глобальными дистрибьюторами электронных компонентов, предоставляет возможность заказывать и получать с международных складов практически любой перечень компонентов в оптимальные для Вас сроки.

На всех этапах разработки и производства наши партнеры могут получить квалифицированную поддержку опытных инженеров.

Система менеджмента качества компании отвечает требованиям в соответствии с ГОСТ Р ИСО 9001, ГОСТ РВ 0015-002 и ЭС РД 009

### Офис по работе с юридическими лицами:

105318, г.Москва, ул.Щербаковская д.3, офис 1107, 1118, ДЦ «Щербаковский»

Телефон: +7 495 668-12-70 (многоканальный)

Факс: +7 495 668-12-70 (доб.304)

E-mail: [info@moschip.ru](mailto:info@moschip.ru)

Skype отдела продаж:

moschip.ru

moschip.ru\_4

moschip.ru\_6

moschip.ru\_9