

PCB terminal block - PTSM 0,5/ 7-2,5-H THR R32 - 1770937

Please be informed that the data shown in this PDF Document is generated from our Online Catalog. Please find the complete data in the user's documentation. Our General Terms of Use for Downloads are valid (<http://phoenixcontact.com/download>)



PCB terminal block, nominal current: 6 A, nom. voltage: 160 V, pitch: 2.5 mm, number of positions: 7, connection method: Push-in spring connection, mounting: THR soldering, conductor/PCB connection direction: 0°, color: black

The figure shows the 3-pos. version

Your advantages

- ✓ Time saving push-in connection, tools not required
- ✓ Defined contact force ensures that contact remains stable over the long term
- ✓ High current carrying capacity of 6 A in very compact dimensions
- ✓ Designed for integration into the SMT soldering process



Key Commercial Data

Packing unit	530 pc
Minimum order quantity	530 pc
GTIN	
GTIN	4046356459518

Technical data

Dimensions

Length [l]	10 mm
Pitch	2.5 mm
Dimension a	15 mm
Width [w]	18 mm
Height	5 mm
Height [h]	7.1 mm
Solder pin [P]	2.1 mm
Pin spacing	5 mm
Hole diameter	1.2 mm

General

PCB terminal block - PTSM 0,5/ 7-2,5-H THR R32 - 1770937

Technical data

General

Range of articles	PTSM 0,5/..-H-THR
Insulating material group	IIIa
Rated surge voltage (III/3)	2.5 kV
Rated surge voltage (III/2)	2.5 kV
Rated surge voltage (II/2)	2.5 kV
Rated voltage (III/3)	63 V
Rated voltage (III/2)	160 V
Rated voltage (II/2)	200 V
Connection in acc. with standard	EN-VDE
Nominal current I_N	6 A
Nominal cross section	0.5 mm ²
Maximum load current	6 A
Insulating material	LCP
Flammability rating according to UL 94	V0
Stripping length	6 mm
Number of positions	7

Connection data

Conductor cross section solid min.	0.14 mm ²
Conductor cross section solid max.	0.5 mm ²
Conductor cross section flexible min.	0.2 mm ²
Conductor cross section flexible max.	0.5 mm ²
Conductor cross section flexible, with ferrule without plastic sleeve min.	0.25 mm ²
Conductor cross section flexible, with ferrule without plastic sleeve max.	0.5 mm ²
Conductor cross section flexible, with ferrule with plastic sleeve min.	0.25 mm ²
Conductor cross section flexible, with ferrule with plastic sleeve max.	0.34 mm ²
Conductor cross section AWG min.	26
Conductor cross section AWG max.	20

Standards and Regulations

Connection in acc. with standard	EN-VDE
	UL
Flammability rating according to UL 94	V0

Environmental Product Compliance

China RoHS	Environmentally friendly use period: unlimited = EFUP-e
	No hazardous substances above threshold values

Drawings

PCB terminal block - PTSM 0,5/ 7-2,5-H THR R32 - 1770937

Drilling diagram

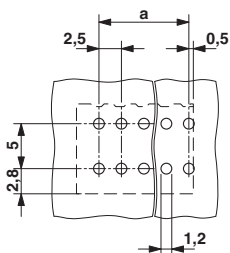

Diagram

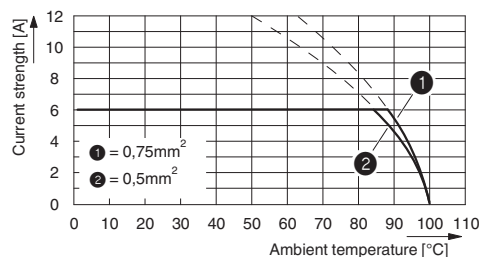

Dimensional drawing

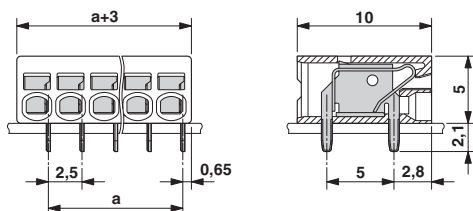

Dimensional drawing

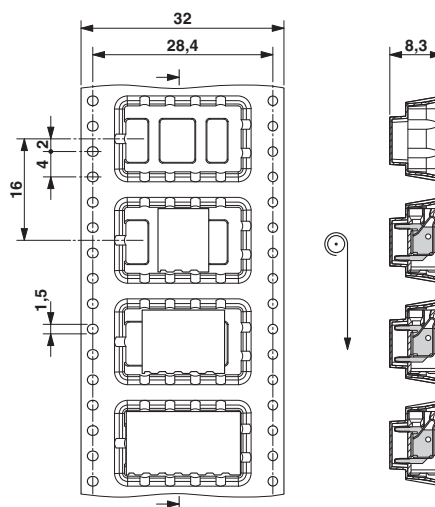

Approvals

Approvals

Approvals

UL Recognized / VDE Zeichengenehmigung / EAC / cULus Recognized

Ex Approvals

Approval details

UL Recognized		http://database.ul.com/cgi-bin/XYV/template/LISEXT/1FRAME/index.htm E118976-20130619
Nominal voltage UN	B	150 V
Nominal current IN		5 A

PCB terminal block - PTSM 0,5/ 7-2,5-H THR R32 - 1770937

Approvals

	B
mm ² /AWG/kcmil	26-18

VDE Zeichengenehmigung		http://www2.vde.com/de/Institut/Online-Service/VDE-gepruefteProdukte/Seiten/Online-Suche.aspx	40048725
------------------------	---	---	----------

EAC		B.01742
-----	---	---------

cULus Recognized		http://database.ul.com/cgi-bin/XYV/template/LISEXT/1FRAME/index.htm	E60425-20030527
	B		
Nominal voltage UN	150 V		
Nominal current IN	5 A		
mm ² /AWG/kcmil	26-20		

Phoenix Contact 2018 © - all rights reserved
<http://www.phoenixcontact.com>

PHOENIX CONTACT GmbH & Co. KG
 Flachsmarktstr. 8
 32825 Blomberg
 Germany
 Tel. +49 5235 300
 Fax +49 5235 3 41200
<http://www.phoenixcontact.com>

Данный компонент на территории Российской Федерации

Вы можете приобрести в компании MosChip.

Для оперативного оформления запроса Вам необходимо перейти по данной ссылке:

<http://moschip.ru/get-element>

Вы можете разместить у нас заказ для любого Вашего проекта, будь то серийное производство или разработка единичного прибора.

В нашем ассортименте представлены ведущие мировые производители активных и пассивных электронных компонентов.

Нашей специализацией является поставка электронной компонентной базы двойного назначения, продукции таких производителей как XILINX, Intel (ex.ALTERA), Vicor, Microchip, Texas Instruments, Analog Devices, Mini-Circuits, Amphenol, Glenair.

Сотрудничество с глобальными дистрибьюторами электронных компонентов, предоставляет возможность заказывать и получать с международных складов практически любой перечень компонентов в оптимальные для Вас сроки.

На всех этапах разработки и производства наши партнеры могут получить квалифицированную поддержку опытных инженеров.

Система менеджмента качества компании отвечает требованиям в соответствии с ГОСТ Р ИСО 9001, ГОСТ РВ 0015-002 и ЭС РД 009

Офис по работе с юридическими лицами:

105318, г.Москва, ул.Щербаковская д.3, офис 1107, 1118, ДЦ «Щербаковский»

Телефон: +7 495 668-12-70 (многоканальный)

Факс: +7 495 668-12-70 (доб.304)

E-mail: info@moschip.ru

Skype отдела продаж:

moschip.ru

moschip.ru_4

moschip.ru_6

moschip.ru_9