

High operation force satisfies the needs in automotive applications. Wide stem & good mountability



Typical Specifications



| Items | Specifications |
|----------------------------|--------------------|
| Rating (max.) | 50mA 16V DC |
| Rating (min.) | 10 μ A 1V DC |
| Initial contact resistance | 500m Ω max. |
| Travel (mm) | 0.2 |

Product Line

Standard type

| Product No. | Operating force | Operating direction | Operating life (5mA 5V DC) | Stem color | Minimum order unit (pcs.) | |
|-------------------|-----------------|---------------------|----------------------------|------------|---------------------------|-------|
| | | | | | Japan | Japan |
| SKRPABE010 | 1.57N | Top push | 100,000cycles | Natural | 4,000 | 4,000 |
| SKRPACE010 | 2.55N | | 50,000cycles | | | |
| SKRPADE010 | 4N | | 100,000cycles | Black | | |
| SKRPARE010 | 5N | | 300,000cycles | | | |

Long-life type

| Product No. | Operating force | Operating direction | Operating life (5mA 5V DC) | Stem color | Minimum order unit (pcs.) | |
|-------------------|-----------------|---------------------|----------------------------|------------|---------------------------|-------|
| | | | | | Japan | Japan |
| SKRPANE010 | 1.57N | Top push | 1,000,000cycles | Natural | 4,000 | 4,000 |
| SKRPASE010 | 2.55N | | 500,000cycles | Black | | |

Packing Specifications

Taping

| Number of packages (pcs.) | | | Tape width (mm) | Export package measurements (mm) |
|---------------------------|----------------|-------------------------|-----------------|----------------------------------|
| 1 reel | 1 case / Japan | 1 case / export packing | | |
| 4,000 | 40,000 | 40,000 | 12 | 395×395×205 |

Note

For reels of 330mm diameter, please inquire.

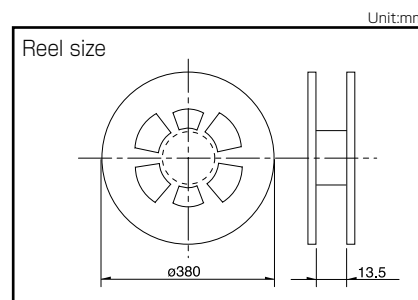

Refer to P.249 for soldering conditions.









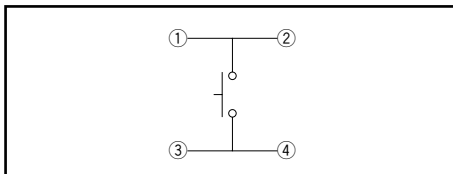







■ Dimensions

Unit:mm

| Style | PC board land dimensions (Viewed from switch mounting face) |
|-------|--|
| | |

■ Circuit Diagram



| Type | | Sharp Feeling Type | | | | | | | |
|-----------------------------|-----------------------------------|--|---|---|---|---|---|---|---|
| | | Surface Mount | | | | | | | |
| Series | | SKRK | SKTH | SKRP | SKQM | SKQY | SKTQ | SKTR | SKSU |
| Photo | |  |  |  |  |  |  |  |  |
| Features | | Compact size Low-profile | Compact size | High operation force Compact size | Compact size | | Middle travel | | |
| Water-proof | | — | — | — | — | — | — | — | ● |
| Dust-proof | | — | ● | — | — | — | — | — | ● |
| IP standard | | — | — | — | — | — | — | — | 67 equivalent |
| Operating direction | Top push | ● | ● | ● | ● | ● | ● | ● | ● |
| | Side push | — | — | — | — | — | — | — | — |
| Dimensions (mm) | W | 3.9 | 3.5 | 4.2 | 6 | 6.1 | 5.3 | □6.1 | 5.3 |
| | D | 2.9 | 3.2 | | 3.5 | 3.7 | 5.4 | | 5.4 |
| | H | 1.5/2 | 1.8/2.5 | 2.5 | 4.3/5 | 2.5 | 4.25 | 4.1 | 3.85/4.34 |
| Operation force coverage | 1N max. | ↕ | ↕ | ↕ | ↕ | ↕ | ↕ | ↕ | ↕ |
| | 1N to 2N | | | | | | | | |
| | 2N to 3N | | | | | | | | |
| | 3N to 4N | | | | | | | | |
| 4N to 5N | ↕ | ↕ | ↕ | ↕ | ↕ | ↕ | ↕ | ↕ | |
| Travel (mm) | | 0.13 | 0.12 | 0.2 | 0.25 | | 0.71 | 0.72 | 0.7/0.9 |
| Ground terminal | | — | — | — | — | ○ | — | — | — |
| Operating temperature range | | -40°C to +85°C | | | -40°C to +90°C | | | | |
| Automotive use | | — | ● | ● | ● | ● | ● | ● | ● |
| Life Cycle | |  |  |  |  |  |  |  |  |
| Electrical performance | Rating (max.) (Resistive load) | 50mA 12V DC | 25mA 16V DC | 50mA 16V DC | 50mA 12V DC | | 50mA 16V DC | | |
| | Rating (min.) (Resistive load) | 10μA 1V DC | | | | | | | |
| | Insulation resistance | 100MΩ min. 100V DC 1min. | | | | | | | |
| | Voltage proof | 250V AC 1min. | 100V AC 1min. | 250V AC 1min. | | | | | |
| Durability | Vibration | 10 to 55 to 10Hz/min., the amplitude is 1.5mm for all the frequencies, in the 3 direction of X, Y and Z for 2 hours respectively | | | | | | | |
| | Lifetime | Shall be in accordance with individual specifications. | | | | | | | |
| Environmental performance | Cold | -40°C 96h | | -40°C 1,000h | -40°C 96h | | -40°C 1,000h | | |
| | Dry heat | 90°C 96h | | 90°C 1,000h | 90°C 96h | | 90°C 1,000h | | |
| | Damp heat | 60°C, 90 to 95%RH 96h | | 60°C, 90 to 95%RH 1,000h | 60°C, 90 to 95%RH 96h | | 60°C, 90 to 95%RH 1,000h | | |
| Page | | 218 | 220 | 222 | 224 | 225 | 227 | 228 | 229 |

W : Width. The most outer dimension excluding terminal portion.
D : Depth. The most outer dimension excluding terminal portion.
H : Height. The minimum dimension if there are variances.

TACT Switch™ Soldering Conditions 249
TACT Switch™ Cautions 250

Notes

- The automotive operating temperature range to be individually discussed upon request.
- Indicates applicability to all products in the series, while ○ indicates applicability to some products in the series.

Condition for Reflow

Available for Surface Mount Type.

Temperature profile



Notes

1. Please confirm the specifications of our product for the detailed condition.
2. Soldering conditions differ depending on reflow soldering machines. Prior verification of soldering condition is highly recommended.

Conditions for Auto-dip

Available for Snap-in Type and Radial Type.

| Items | Condition |
|------------------------|---|
| Flux built-up | Mounting surface should not be exposed to flux |
| Preheating temperature | Ambient temperature of the soldered surface of PC board. 100°C max. |
| Preheating time | 60s max. |
| Soldering temperature | 260°C max. |
| Duration of immersion | 5s max. |
| Number of soldering | 2times max. |

SKHH Series

| Items | Condition |
|------------------------|---|
| Flux built-up | Mounting surface should not be exposed to flux |
| Preheating temperature | Ambient temperature of the soldered surface of PC board. 110°C max. |
| Preheating time | 60s max. |
| Soldering temperature | 260°C max. |
| Duration of immersion | 5s max. |
| Number of soldering | 2times max. |

SKHL Top Push Type, SKQJ Series

| Items | Condition |
|------------------------|---|
| Flux built-up | Mounting surface should not be exposed to flux |
| Preheating temperature | Ambient temperature of the soldered surface of PC board. 100°C max. |
| Preheating time | 45s max. |
| Soldering temperature | 255°C max. |
| Duration of immersion | 5s max. |
| Number of soldering | 2times max. |

Notes

1. Prevent flux penetration from the top side of the TACT Switch™.
2. Switch terminals and a PC board should not be coated with flux prior to soldering.
3. The second soldering should be done after the switch is stable with normal temperature.
4. Use the flux with a specific gravity of min 0.81.
(EC-19S-8 by TAMURA CORPORATION, or equivalents.)

Manual Soldering

| Items | Condition |
|----------------------------|------------|
| Soldering temperature | 350°C max. |
| Duration of soldering | 3s max. |
| Capacity of soldering iron | 60W max. |

SKHH, SKHW Series

| Items | Condition |
|----------------------------|------------|
| Soldering temperature | 360°C max. |
| Duration of soldering | 3s max. |
| Capacity of soldering iron | 60W max. |

SKTD, SKTG, SKQJ Series

| Items | Condition |
|----------------------------|------------|
| Soldering temperature | 350°C max. |
| Duration of soldering | 3s max. |
| Capacity of soldering iron | 20W max. |

Данный компонент на территории Российской Федерации

Вы можете приобрести в компании MosChip.

Для оперативного оформления запроса Вам необходимо перейти по данной ссылке:

<http://moschip.ru/get-element>

Вы можете разместить у нас заказ для любого Вашего проекта, будь то серийное производство или разработка единичного прибора.

В нашем ассортименте представлены ведущие мировые производители активных и пассивных электронных компонентов.

Нашей специализацией является поставка электронной компонентной базы двойного назначения, продукции таких производителей как XILINX, Intel (ex.ALTERA), Vicor, Microchip, Texas Instruments, Analog Devices, Mini-Circuits, Amphenol, Glenair.

Сотрудничество с глобальными дистрибьюторами электронных компонентов, предоставляет возможность заказывать и получать с международных складов практически любой перечень компонентов в оптимальные для Вас сроки.

На всех этапах разработки и производства наши партнеры могут получить квалифицированную поддержку опытных инженеров.

Система менеджмента качества компании отвечает требованиям в соответствии с ГОСТ Р ИСО 9001, ГОСТ РВ 0015-002 и ЭС РД 009

Офис по работе с юридическими лицами:

105318, г.Москва, ул.Щербаковская д.3, офис 1107, 1118, ДЦ «Щербаковский»

Телефон: +7 495 668-12-70 (многоканальный)

Факс: +7 495 668-12-70 (доб.304)

E-mail: info@moschip.ru

Skype отдела продаж:

moschip.ru

moschip.ru_4

moschip.ru_6

moschip.ru_9