

Features

- Attenuation: 1.0 dB Steps to 31 dB
- High Accuracy to 6 GHz
- Small Footprint, JEDEC Package
- Integral TTL driver
- 50 ohm impedance
- Test boards are available
- Tape and Reel Packaging Available
- Lead-Free CSP-1 Package
- 100% Matte Tin Plating over Copper
- Halogen-Free “Green” Mold Compound
- 260°C Reflow Compatible
- RoHS* Compliant Version of AT90-0001

Description

M/A-COM’s MAAD-007083-000100 is a GaAs FET 5-bit digital attenuator with an integral TTL driver. Step size is 1.0 dB providing 31 dB total attenuation range. This device is in a 32 lead FQFP-N surface mount package. Due to superior grounding techniques this digital attenuator offers superior performance to 6 GHz. The MAAD-007083-000100 is ideally suited for use where accuracy, fast speed, very low power consumption and low costs are required.

Ordering Information

Part Number	Package
MAAD-007083-000100	Bulk Packaging
MAAD-007083-0001TR	1000 piece reel
MAAD-007083-0001TB	Sample Test Board

Note: Reference Application Note M513 for reel size information.

* Restrictions on Hazardous Substances, European Union Directive 2002/95/EC.

Functional Schematic

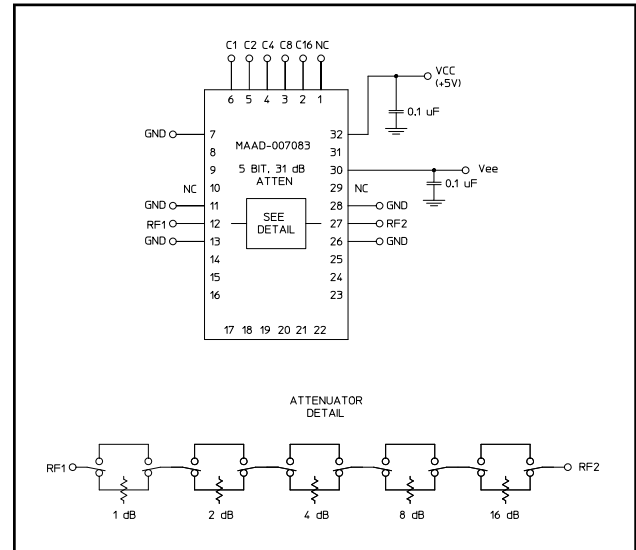

Pin Configuration¹

Pin No.	Function	Pin No.	Function
1	NC	17	NC
2	C16	18	NC
3	C8	19	NC
4	C4	20	NC
5	C2	21	NC
6	C1	22	NC
7	GND	23	NC
8	NC	24	NC
9	NC	25	NC
10	NC ²	26	GND
11	GND	27	RF2
12	RF1	28	GND
13	GND	29	NC ²
14	NC	30	-Vee
15	NC	31	NC
16	NC	32	+Vcc

1. The exposed pad centered on the package bottom must be connected to RF and DC ground. (For PQFN Packages)
2. Pins 10 and 29 must be isolated.

ADVANCED: Data Sheets contain information regarding a product M/A-COM Technology Solutions is considering for development. Performance is based on target specifications, simulated results, and/or prototype measurements. Commitment to develop is not guaranteed.
PRELIMINARY: Data Sheets contain information regarding a product M/A-COM Technology Solutions has under development. Performance is based on engineering tests. Specifications are typical. Mechanical outline has been fixed. Engineering samples and/or test data may be available. Commitment to produce in volume is not guaranteed.

• **North America** Tel: 800.366.2266 • **Europe** Tel: +353.21.244.6400
 • **India** Tel: +91.80.4155721 • **China** Tel: +86.21.2407.1588
 Visit www.macomtech.com for additional data sheets and product information.

M/A-COM Technology Solutions Inc. and its affiliates reserve the right to make changes to the product(s) or information contained herein without notice.

Digital Attenuator, 31.0 dB, 5-Bit, TTL Driver, DC-6.0 GHz

Rev. V4

Electrical Specifications: $T_A = 25^\circ\text{C}$, $Z_0 = 50\Omega$, $V_{CC} = 5.0\text{V}$, $V_{EE} = -5.0\text{V}$

Parameter	Test Conditions	Frequency	Units	Min	Typ	Max
Insertion Loss	—	DC - 2.0 GHz	dB	—	2.5	3.1
		DC - 4.0 GHz	dB	—	3.3	3.8
		DC - 6.0 GHz	dB	—	5.0	5.8
Attenuation Accuracy	1 to 24 dB Bits	DC - 6.0 GHz	dB	—	—	$\pm(0.3 + 4\% \text{ of atten.})$
	25 to 31 dB Bits	DC - 6.0 GHz	dB	—	—	$\pm(0.3 + 5\% \text{ of atten.})$
VSWR	Full Range	DC - 2.0 GHz	Ratio	—	1.4:1	1.7:1
		DC - 6.0 GHz	Ratio	—	1.7:1	2.4:1
1 dB Compression	—	50 MHz	dBm	—	+22	—
		0.5 - 6.0 GHz	dBm	—	+24	—
Input IP2	Two tone inputs to +5 dBm	50 MHz	dBm	—	+43	—
		0.5 - 6.0 GHz	dBm	—	+60	—
Input IP3	Two-tone inputs up to +5 dBm	50 MHz	dB	—	+37	—
		0.5-6.0 GHz	dB	—	+48	—
V _{CC}	—	—	V	4.75	5.0	5.25
V _{EE}	—	—	V	-8.0	-5.0	-4.75
Switching Speed	50% Cntl to 90%/10% RF 10% to 90% or 90% to 10%	—	ns	—	25	—
		—	ns	—	15	—
V _{IL}	LOW-level input voltage	—	V	0.0	-	0.8
V _{IH}	HIGH-level input voltage	—	V	2.0	-	5.0
I _{in} (Input Leakage Current)	V _{in} = V _{CC} or GND	—	uA	-1.0	-	1.0
I _{CC} (Quiescent Supply Current)	V _{cntrl} = V _{CC} or GND	—	uA	—	250	400
ΔI_{CC}^3 (Additional Supply Current Per TTL Input Pin)	V _{CC} = Max, V _{cntrl} = V _{CC} - 2.1V	—	mA	—	—	1.0
I _{EE}	V _{EE} min to max, V _{in} = V _{IL} or V _{IH}	—	mA	-1.0	-0.2	-
Thermal Resistance θ_{JC}	—	—	°C/W	—	15	—

3. The 16 dB bit is connected to two driver input pins, so ΔI_{CC} needs to be calculated based on 6 TTL inputs.

Truth Table (Digital Attenuator)

C16	C8	C4	C2	C1	Attenuation
0	0	0	0	0	Loss, Reference
0	0	0	0	1	1 dB
0	0	0	1	0	2 dB
0	0	1	0	0	4 dB
0	1	0	0	0	8 dB
1	0	0	0	0	16 dB
1	1	1	1	1	31 dB

0 = TTL Low; 1 = TTL High

Absolute Maximum Ratings^{4,5}

Parameter	Absolute Maximum
Max. Input Power 0.05 GHz 0.5 - 6.0 GHz	+27 dBm +34 dBm
V _{CC}	-0.5V ≤ V _{CC} ≤ +7.0V
V _{EE}	-8.5V ≤ V _{EE} ≤ +0.5V
V _{CC} - V _{EE}	-0.5V ≤ V _{CC} - V _{EE} ≤ 14.5V
V _{in} ⁶	-0.5V ≤ V _{in} ≤ V _{CC} + 0.5V
Operating Temperature	-40°C to +85°C
Storage Temperature	-65°C to +125°C

4. Exceeding any one or combination of these limits may cause permanent damage to this device.
 5. M/A-COM does not recommend sustained operation near these survivability limits.
 6. Standard CMOS TTL interface, latch-up will occur if logic signal is applied prior to power supply.

Handling Procedures

Please observe the following precautions to avoid damage:

Static Sensitivity

Gallium Arsenide Integrated Circuits are sensitive to electrostatic discharge (ESD) and can be damaged by static electricity. Proper ESD control techniques should be used when handling these devices.

Moisture Sensitivity

The MSL rating for this part is defined as Level 2 per IPC/JEDEC J-STD-020. Parts shall be stored and/or baked as required for MSL Level 2 parts.

Typical Performance Curves

Insertion Loss vs. Frequency

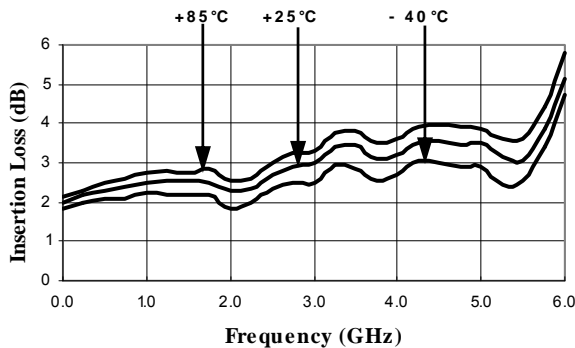

Accuracy (dB) vs. Frequency

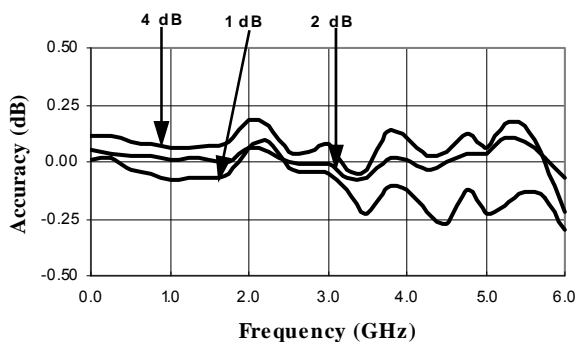

Recommended PCB Configuration⁷

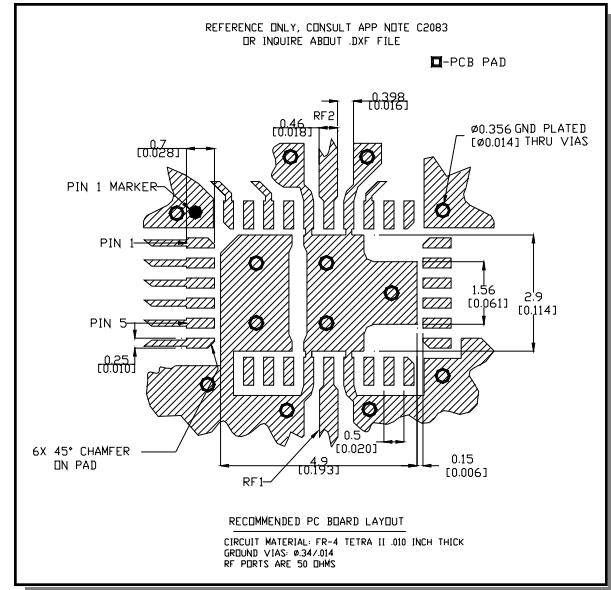

7. Application Note S2083 is available on line at www.macom.com

VSWR vs. Frequency

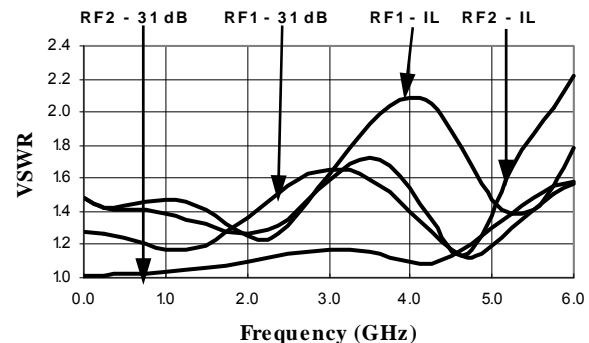

Accuracy (dB) vs. Frequency

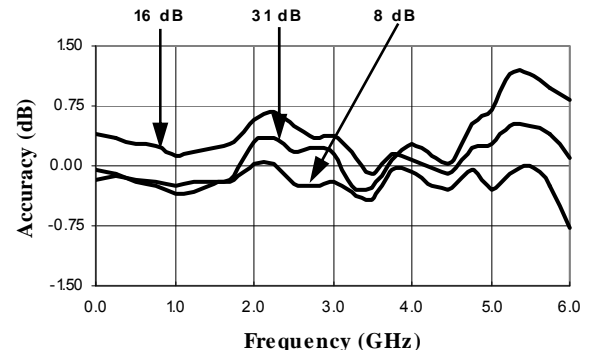

**CSP-1, Lead-Free 4 x 6 mm, 32-lead
PQFN[†]**

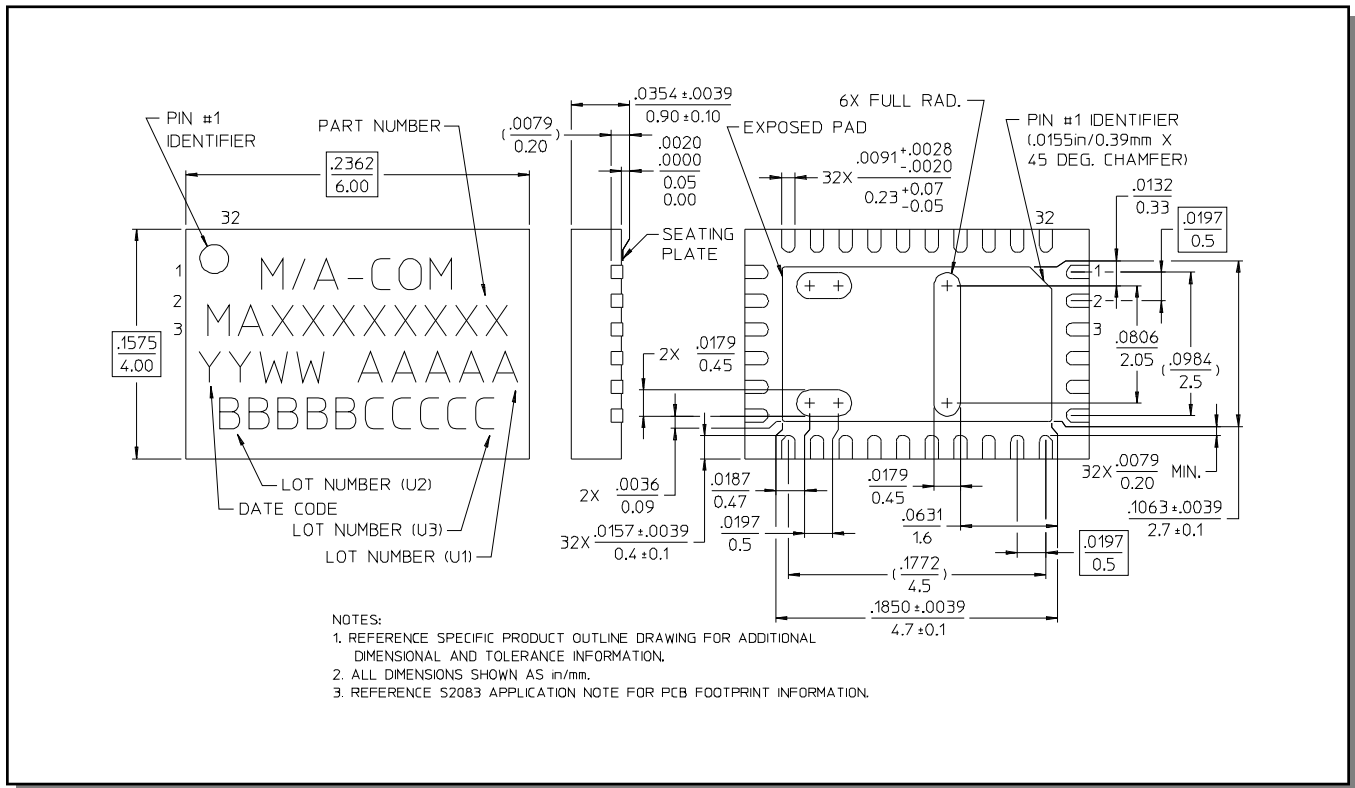

[†] Reference Application Note M538 for lead-free solder reflow recommendations.

Данный компонент на территории Российской Федерации

Вы можете приобрести в компании MosChip.

Для оперативного оформления запроса Вам необходимо перейти по данной ссылке:

<http://moschip.ru/get-element>

Вы можете разместить у нас заказ для любого Вашего проекта, будь то серийное производство или разработка единичного прибора.

В нашем ассортименте представлены ведущие мировые производители активных и пассивных электронных компонентов.

Нашей специализацией является поставка электронной компонентной базы двойного назначения, продукции таких производителей как XILINX, Intel (ex.ALTERA), Vicor, Microchip, Texas Instruments, Analog Devices, Mini-Circuits, Amphenol, Glenair.

Сотрудничество с глобальными дистрибьюторами электронных компонентов, предоставляет возможность заказывать и получать с международных складов практически любой перечень компонентов в оптимальные для Вас сроки.

На всех этапах разработки и производства наши партнеры могут получить квалифицированную поддержку опытных инженеров.

Система менеджмента качества компании отвечает требованиям в соответствии с ГОСТ Р ИСО 9001, ГОСТ РВ 0015-002 и ЭС РД 009

Офис по работе с юридическими лицами:

105318, г.Москва, ул.Щербаковская д.3, офис 1107, 1118, ДЦ «Щербаковский»

Телефон: +7 495 668-12-70 (многоканальный)

Факс: +7 495 668-12-70 (доб.304)

E-mail: info@moschip.ru

Skype отдела продаж:

moschip.ru

moschip.ru_4

moschip.ru_6

moschip.ru_9