

MAX40010

76V Precision, High-Voltage, Current-Sense Amplifier

General Description

The MAX40010 single-channel high-side precision current-sense amplifier with an input common-mode voltage range from 2.7V to 76V, making it ideal for communications, automotive, data centers and other systems where high-voltage current monitoring is critical. The MAX40010 offer accuracy specifications of less than 12 μ V (max) Input Offset voltage and less than 0.1% (max) gain error. By offering precision offset and gain error specifications, the MAX40010 makes it possible to sense very small sense/shunt resistors, further improving system efficiencies and power dissipation through the sense element.

The MAX40010 features 80kHz of small signal bandwidth and four unique gain options (12.5V/V, 20V/V, 50V/V, and 100V/V). The device's current sense inputs have EMIR filters to reject RF found in communications equipment.

The MAX40010 operates over the -40 $^{\circ}$ C to + 125 $^{\circ}$ C temperature range and is offered in a 6-bump, 1mm x 1.5mm wafer-lever package (WLP) with 0.5mm pitch and a SOT23 U6SN+1 package.

Benefits and Features

- Input Common Mode +2.7V to +76V
- Ultra-Tiny 1mm x 1.5mm 6-bump WLP and SOT23 Packages
- Low 12 μ V (max) Input Offset Voltage
- Low 0.1%(max) Gain Error
- Available Gain Options:
 - G = 12.5V/V: MAX40010L
 - G = 20V/V: MAX40010T
 - G = 50V/V: MAX40010F
 - G = 100V/V: MAX40010H

Applications

- Base-Station and Communication Equipment
- Server Backplanes/Data Centers
- Automotive Sensing
- Energy Management
- Solar Panel Monitoring

Ordering Information appears at end of data sheet.

Typical Operating Circuit

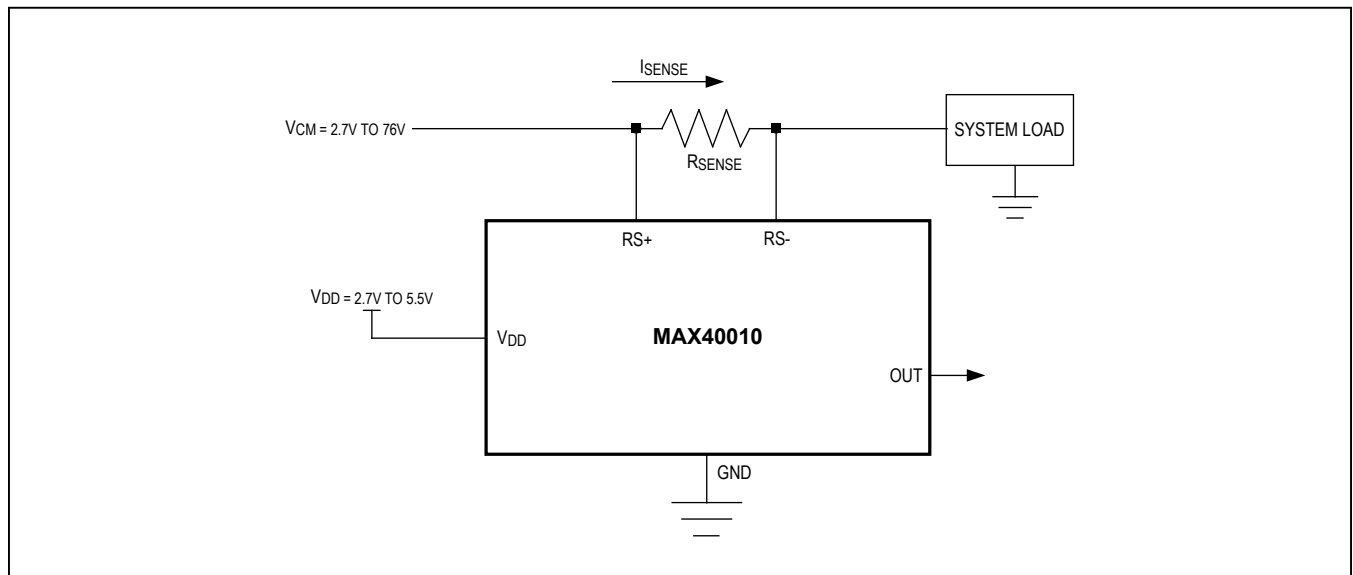

Absolute Maximum Ratings

| | | | |
|------------------------------------------------|----------------|---------------------------------------------------|-----------------|
| V _{DD} to GND | -0.3V to +6.0V | Operating Temperature Range..... | -40°C to +125°C |
| RS+, RS- to GND | -0.3V to +80V | Junction Temperature..... | +150°C |
| RS+ to RS- (Continuous) | ±24V | Storage Temperature Range..... | -65°C to +150°C |
| Continuous (> 1s) Input Current (Any Pin)..... | ±10mA | Reflow Soldering Peak Temperature (Pb-free) | +260°C |

Package Thermal Characteristics (Note 1)

| | | | |
|-----------------------------------------------------------------|-----------|-----------------------------------------------------------------|-----------|
| 6-Bump WLP | | 6-Pin SOT23 | |
| Continuous Power Dissipation (Derate mW/°C above +70°C)..... | 12.34mW | Continuous Power Dissipation (Derate mW/°C above +70°C)..... | 13.40mW |
| Junction-to-Ambient Thermal Resistance (θ _{JA}) | 81.03°C/W | Junction-to-Ambient Thermal Resistance (θ _{JA}) | 74.60°C/W |
| | | Junction-to-Case Thermal Resistance (θ _{JC}) | 6.0°C/W |

Note 1: Package thermal resistances were obtained using the method described in JEDEC specification JESD51-7, using a four-layer board. For detailed information on package thermal considerations, refer to www.maximintegrated.com/thermal-tutorial.

Stresses beyond those listed under "Absolute Maximum Ratings" may cause permanent damage to the device. These are stress ratings only, and functional operation of the device at these or any other conditions beyond those indicated in the operational sections of the specifications is not implied. Exposure to absolute maximum rating conditions for extended periods may affect device reliability.

Electrical Characteristics

(V_{RS+} = V_{RS-} = +36V, V_{DD} = +3.3V, V_{SENSE} = V_{RS+} - V_{RS-} = 1mV, T_A = -40°C to +125°C unless otherwise noted. Typical values are at T_A = +25°C). (Note 2)

| PARAMETER | SYMBOL | CONDITIONS | MIN | TYP | MAX | UNITS |
|-------------------------------------------------------------|-------------------------------------|----------------------------------------------|-----|-----|-----|-------|
| DC CHARACTERISTICS | | | | | | |
| Supply Voltage | V _{DD} | Guaranteed by PSRR | 2.7 | | 5.5 | V |
| Supply Current | I _{DD} | T _A = +25°C | | 350 | | µA |
| | | -40°C < T _A < +125°C | | | 800 | |
| Power-Supply Rejection Ratio | PSRR | 2.7V ≤ V _{DD} ≤ 5.5V | 110 | 120 | | dB |
| Input Common-Mode Voltage Range | V _{CM} | Guaranteed by CMRR | 2.7 | | 76 | V |
| Input Bias Current at V _{RS+} and V _{RS-} | I _{RS+} , I _{RS-} | | | | 65 | µA |
| Input Offset Current | I _{RS+} - I _{RS-} | | | | 400 | nA |
| Input Leakage Current | I _{RS+} , I _{RS-} | V _{DD} = 0V, V _{RS+} = 76V | | | 5 | µA |
| Common-Mode Rejection Ratio | CMRR | +4.5V < V _{RS+} < +76V | 125 | 140 | | dB |
| Input Offset Voltage | V _{OS} | T _A = +25°C | | | ±12 | µV |
| | | -40°C ≤ T _A ≤ +85°C | | | ±25 | |
| | | -40°C ≤ T _A ≤ +125°C | | | ±25 | |
| Input Offset Voltage Drift | TCV _{OS} | | | | 130 | nV/°C |
| Input Sense Voltage | V _{SENSE} | MAX40010L (G = 12.5V/V) | | 200 | | mV |
| | | MAX40010T (G = 20V/V) | | 125 | | |
| | | MAX40010F (G = 50V/V) | | 50 | | |
| | | MAX40010H (G=100V/V) | | 25 | | |

Electrical Characteristics (continued)

($V_{RS+} = V_{RS-} = +36V$, $V_{DD} = +3.3V$, $V_{SENSE} = V_{RS+} - V_{RS-} = 1mV$, $T_A = -40^{\circ}C$ to $+125^{\circ}C$ unless otherwise noted. Typical values are at $T_A = +25^{\circ}C$). (Note 2)

| PARAMETER | SYMBOL | CONDITIONS | MIN | TYP | MAX | UNITS |
|---------------------------------|------------|-----------------------------------------------------------------------------------------------------------------------------|------------------|------|-----|-----------------|
| Gain (Note 3) | G | Full-Scale $V_{SENSE} = 200mV$, Int. reference = 2.5V | | 12.5 | | V/V |
| | | Full-Scale $V_{SENSE} = 125mV$, Int. reference = 2.5V | | 20 | | |
| | | Full-Scale $V_{SENSE} = 50mV$, Int. reference = 2.5V | | 50 | | |
| | | Full-Scale $V_{SENSE} = 25mV$, Int. reference = 2.5V | | 100 | | |
| Gain Error | GE | $T_A = +25^{\circ}C$ | | | 0.1 | % |
| | | $-40^{\circ}C \leq T_A \leq +85^{\circ}C$ | | | 0.5 | |
| | | $-40^{\circ}C \leq T_A \leq +125^{\circ}C$ | | | 0.7 | |
| Output Resistance | R_{OUT} | | | 0.1 | | m Ω |
| Output Low Voltage | V_{OL} | Sink 500 μA | | | 15 | mV |
| Output High Voltage | V_{OH} | Source 500 μA | $V_{DD} - 0.016$ | | | V |
| AC CHARACTERISTICS | | | | | | |
| Signal Bandwidth | BW -3dB | Gain = 50V/V Configuration $V_{SENSE} > 5mV$ | | 80 | | kHz |
| AC Power Supply Rejection Ratio | AC PSRR | $f = 200kHz$ | | 40 | | dB |
| AC CMRR | AC CMRR | $f = 200kHz$ | | 48 | | dB |
| Output Transient Recovery Time | | $\Delta V_{OUT} = 2V_{P-P}$, 0.1% final V_{OUT} settling with 400 Ω and 1nF onto 6pF ADC input sampling capacitor | | 2 | | μs |
| Capacitive load stability | C_{LOAD} | With 240 Ω isolation resistor | | 20 | | nF |
| | | Without any isolation resistor | | 200 | | pF |
| Input Voltage Noise Density | e_n | $f = 1kHz$ | | 65 | | nV/ \sqrt{Hz} |
| Total Harmonic Distortion | THD | $f = 1kHz$, $V_{OUT} = 1V_{P-P}$ | | 60 | | dB |
| Power-up time (Note 4) | | | | 200 | | μs |
| Saturation Recovery Time | | | | 10 | | μs |

Note 2: All Devices are 100% production tested at $T_A = +25^{\circ}C$. All temperature limits are guaranteed by design.

Note 3: Gain and offset voltage are calculated based on two point measurements: $V_{SENSE1} = 20\%$ full scale and $V_{SENSE2} = 80\%$ full scale

Note 4: Output is high-Z during power-up.

Typical Operating Characteristics

($V_{RS+} = V_{RS-} = +36V$, $V_{DD} = +3.3V$, $V_{SENSE} = V_{RS+} - V_{RS-} = 1mV$, $T_A = -40^{\circ}C$ to $+125^{\circ}C$, unless otherwise noted. Typical values are at $T_A = +25^{\circ}C$)

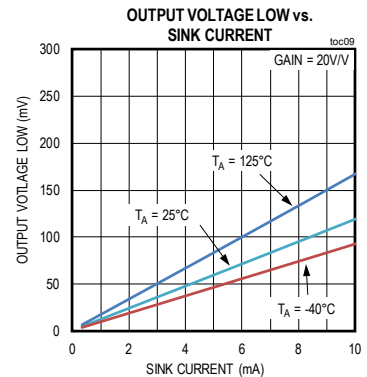
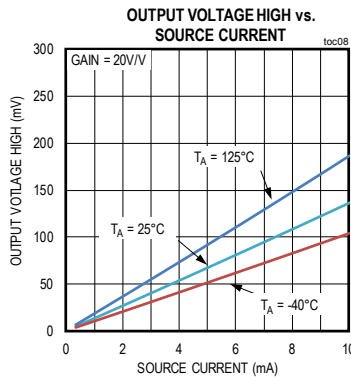
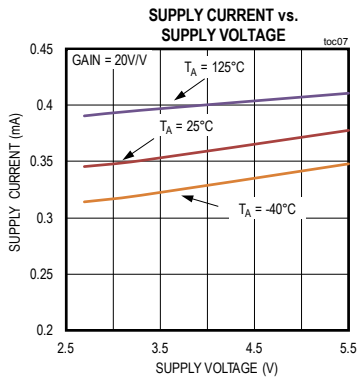
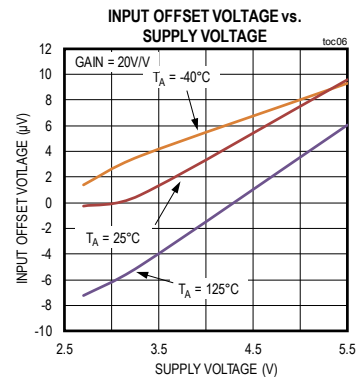
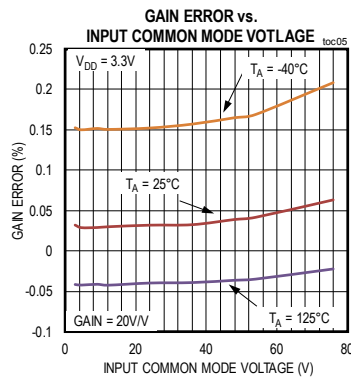
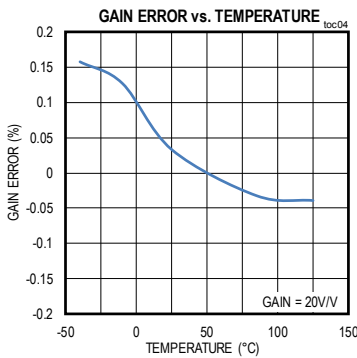
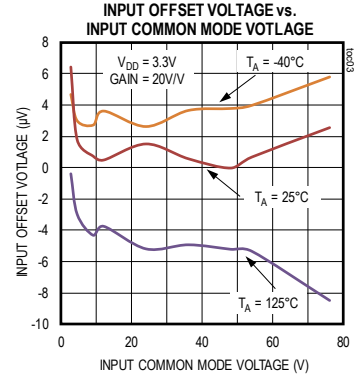
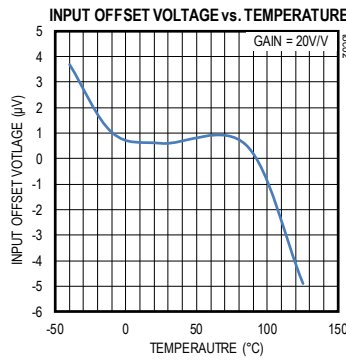
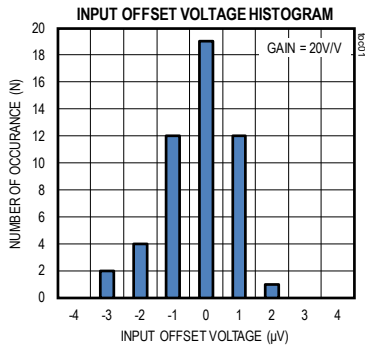

Typical Operating Characteristics (continued)

($V_{RS+} = V_{RS-} = +36V$, $V_{DD} = +3.3V$, $V_{SENSE} = V_{RS+} - V_{RS-} = 1mV$, $T_A = -40^{\circ}C$ to $+125^{\circ}C$, unless otherwise noted. Typical values are at $T_A = +25^{\circ}C$)

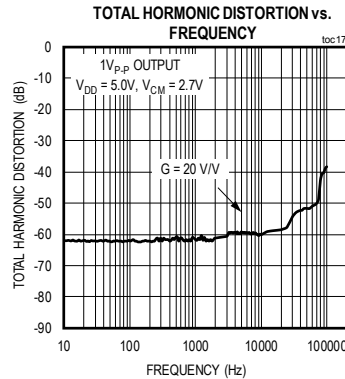
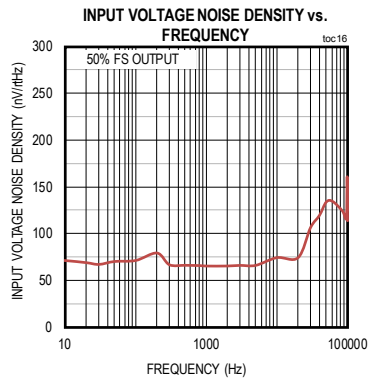
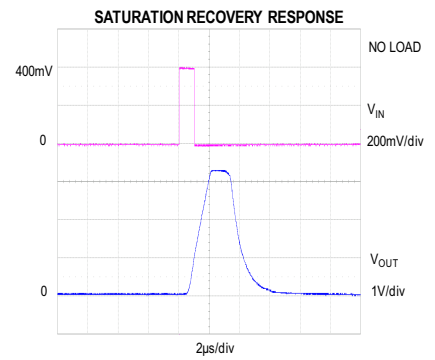
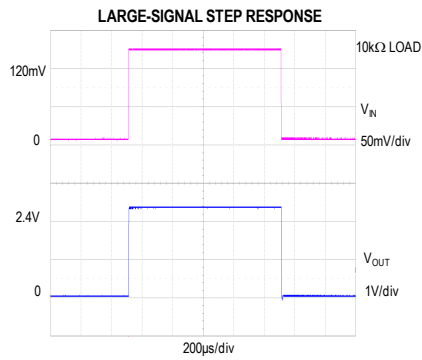
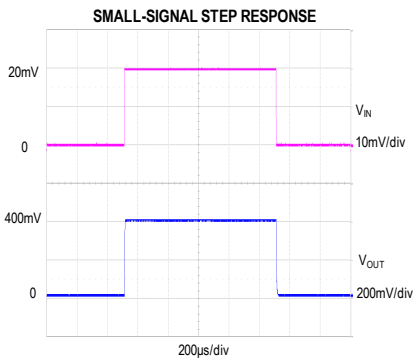
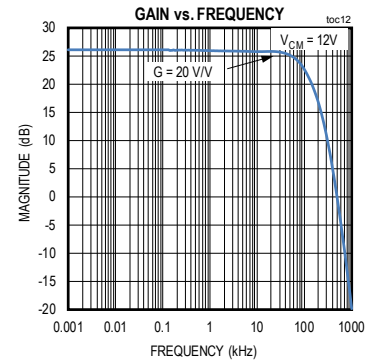
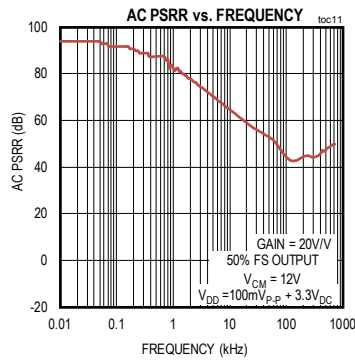
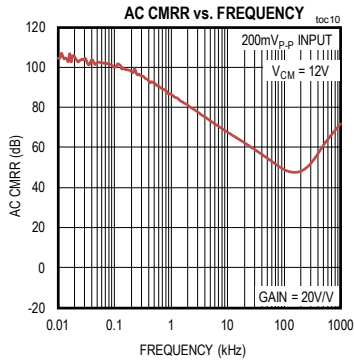

Pin Configurations

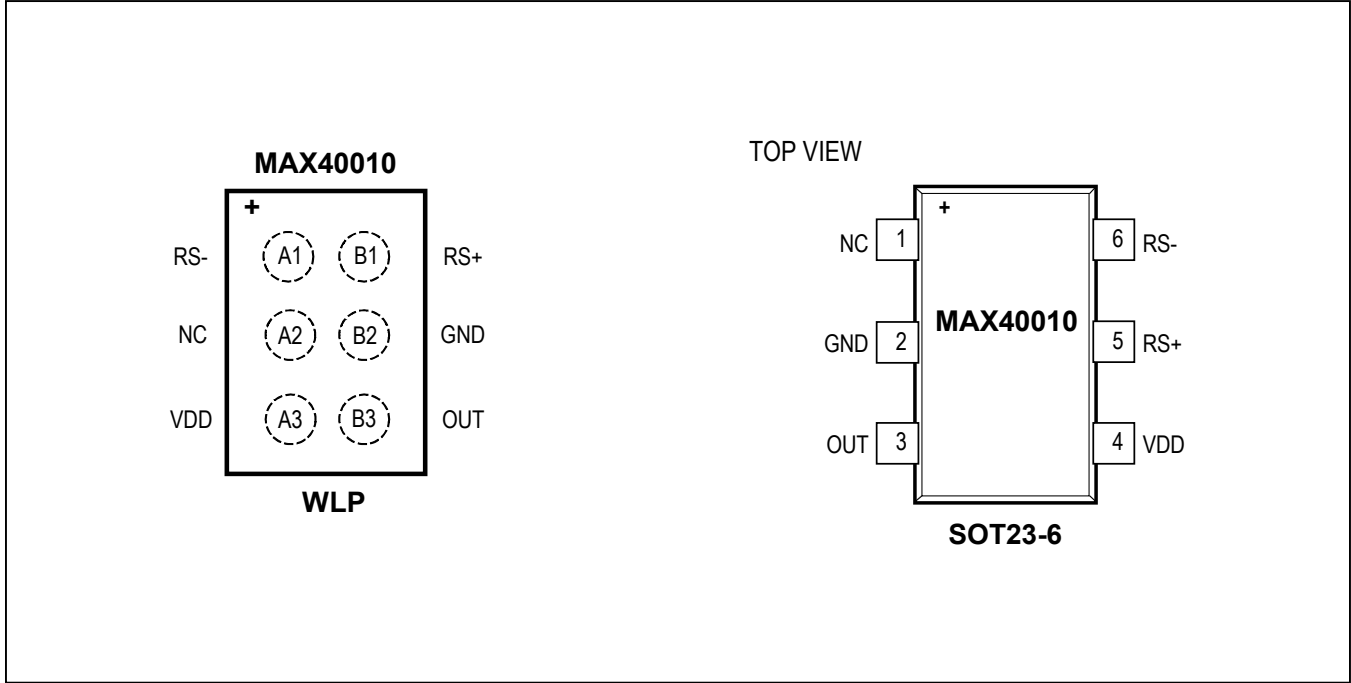

Pin Description

| PIN | | NAME | FUNCTION |
|-----|-------|------|--------------------------------------------------------------------------------------|
| WLP | SOT23 | | |
| B1 | 5 | RS+ | External Resistor Power-Side Connection Input |
| A1 | 6 | RS- | External Resistor Load-Side Connection Input |
| A3 | 4 | VDD | Supply Voltage Input |
| B2 | 2 | GND | Ground or Supply Return Input |
| B3 | 3 | OUT | Output. Output is proportional to the magnitude of differential sense input voltage. |
| A2 | 1 | NC | No Connect. |

Functional (or Block) Diagram

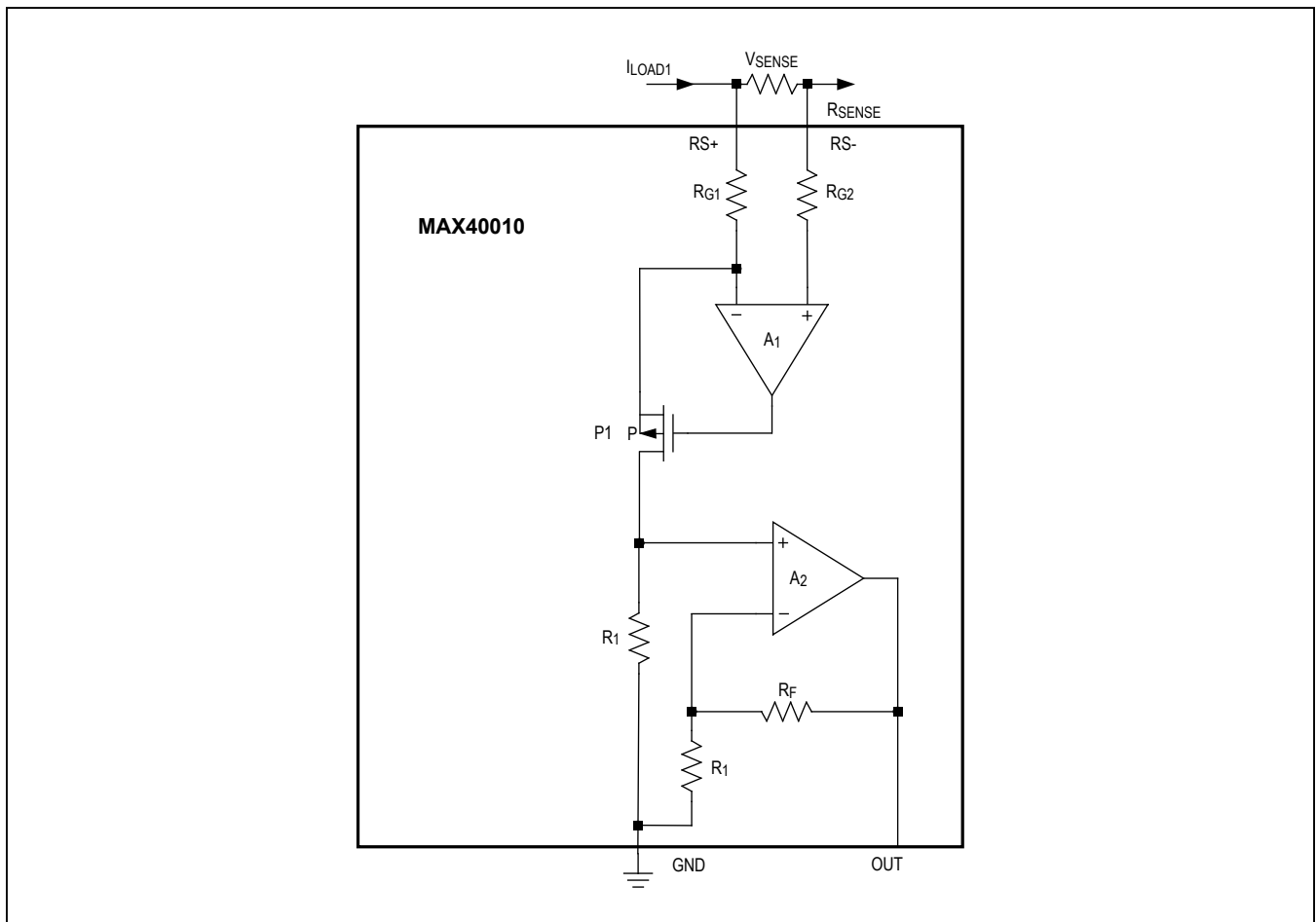

Figure 1 : MAX40010 Functional Diagram

Detailed Description

The MAX40010 high-side, current-sense amplifiers feature a 2.7V to 76V input common-mode range that is independent of supply voltage. This feature allows the monitoring of current out of a battery as low as 2.7V and enables high-side current sensing at voltages greater than the supply voltage (VDD). The MAX40010 monitors current through an external current-sense resistor and amplifies the voltage across the resistor.

High-side current monitoring does not interfere with the ground path of the load being measured, making the MAX40010 particularly useful in a wide range of high-voltage systems.

The MAX40010 operates as follows: current from the source flows through R_{SENSE} to the load (Figure 1), creating a sense voltage, V_{SENSE} . The internal op amp A1 force the current through an internal gain resistor $RG1$ at $RS+$ input, such that its voltage drop equals the voltage drop (V_{SENSE}) across the external sense resistors (R_{SENSE}). The internal resistor at $RS-$ input ($RG2$) has the same value as $RG1$ to minimize the error. The current through $RG1$ is sourced by a high-voltage p-channel FET. Its source current is the same as the drain current which flows through a second gain resistor, $R1$, producing a voltage $VR1 = V_{SENSE} \times R1 / RG1$.

The output voltage V_{OUT} is produced from a second op amp A2 with the gain $(1 + RF1 / R1)$. Hence the $V_{OUT} = I_{LOAD} \times R_{SENSE} (R1 / RG1) \times (1 + RF1 / R1)$. The value of internal resistors $R1$, $R2$, $RG1$, $RG2$, RF are available in Table 1.

Total gain is 12.5V/V for MAX40010L, 20V/V for the MAX40010T, 50V/V for the MAX40010F and 100V/V for the MAX40010H.

Table 1. Internal Gain-Setting Resistors

| | GAIN (V/V) | R1, R2 (kΩ) | RG1, RG2 (kΩ) | RF (kΩ) |
|-----------|------------|-------------|---------------|---------|
| MAX40010L | 12.5 | 25 | 10 | 100 |
| MAX40010T | 20 | 25 | 10 | 175 |
| MAX40010F | 50 | 25 | 10 | 475 |
| MAX40010H | 100 | 25 | 10 | 975 |

Application Information

Recommended Component Values

Ideally, the maximum load current develops the full-scale sense voltage across the current-sense resistor. Choose the gain needed to yield the maximum output voltage required for the application:

$$V_{OUT} = V_{SENSE} \times AV$$

where V_{SENSE} is the full-scale sense voltage, 200mV for gain of 12.5V/V, 125mV for gain of 20V/V, 50mV for gain of 50V/V, 25mV for gain of 100V/V, and AV is the gain of the device.

In applications monitoring a high current, ensure that R_{SENSE} is able to dissipate its own I^2R loss. If the resistor's power dissipation exceeds the nominal value, its value may drift or it may fail altogether.

The MAX40010 sense a wide variety of currents with different sense-resistor values.

Choosing the Sense Resistor

Choose R_{SENSE} based on the following criteria:

- **Voltage Loss:** A high R_{SENSE} value causes the power-source voltage to degrade through IR loss. For minimal voltage loss, use the lowest R_{SENSE} value.
- **Accuracy:** A high R_{SENSE} value allows lower currents measured more accurately. This is due to offsets becoming less significant when the sense voltage is larger. For best performance, select R_{SENSE} to provide approximately 200mV (gain of 12.5V/V), 125mV (gain of 20V/V), or 50mV (gain of 50V/V), 25mV (gain of 100V/V) of sense voltage for the full-scale current in each application.

• **Efficiency and Power Dissipation:** At high current levels, the I^2R losses in R_{SENSE} can be significant. Consider this when choosing the resistor value and its power dissipation (wattage) rating. In addition, the sense resistor's value might drift if it heats up excessively.

• **Inductance:** Keep inductance low if I_{SENSE} has a large high-frequency component. Wire-wound resistors have the highest inductance, while metal film is somewhat better. Low-inductance, metal-film resistors are also available. Instead of being spiral wrapped around a core, as in metal-film or wire wound resistors, they are a straight band of metal and are available in values under 1Ω .

Take care to eliminate parasitic trace resistance from causing errors in the sense voltage because of the high currents that flow through R_{SENSE} . Either use a four terminal current-sense resistor or use Kelvin (force and sense) PC board layout techniques.

EMIRR Input Filter

These devices have input EMI filters to prevent effects of radio frequency interference on the output. The EMI filters comprise passive devices that present significant higher impedance to RF signals. See the EMIRR vs. Frequency plot in the Typical Operating Characteristics section for details.

Typical Application Circuit

An example of typical application (Figure 2) of this high-voltage, high-precision current-sense amplifier is in base station systems where there is a need to monitor the current flowing in the power amplifier. Such amplifier, depending on the technology, can be biased up to 50V or 60V thus requiring a current-sense amplifier like the MAX40010 with high voltage common mode. The very low input offset voltage of the MAX40010 minimizes the value of the external sense resistor, resulting in system power saving.

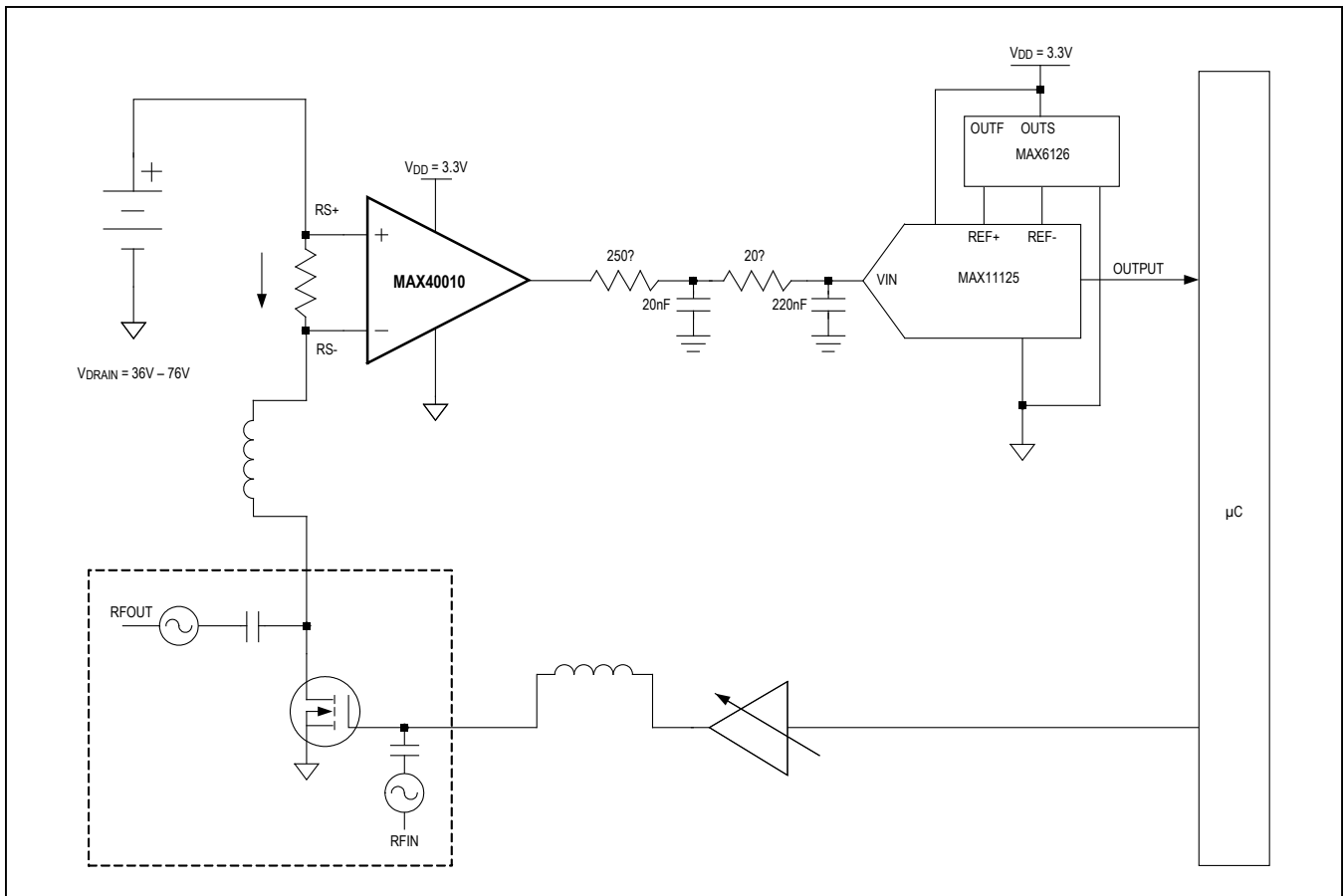

Figure 2: MAX40010 Used in Base Station Application

Ordering Information

| PART | GAIN(V/V) | TEMP RANGE | PIN-PACKAGE | TOP-MARK |
|----------------|-----------|-----------------|-------------|----------|
| MAX40010LAUT+* | 12.5 | -40°C to +125°C | 6 SOT23 | +ACUR |
| MAX40010LAWT+* | 12.5 | -40°C to +125°C | 6 WLP | +DX |
| MAX40010TAUT+* | 20 | -40°C to +125°C | 6 SOT23 | +ACUS |
| MAX40010TAWT+* | 20 | -40°C to +125°C | 6 WLP | +DY |
| MAX40010FAUT+ | 50 | -40°C to +125°C | 6 SOT23 | +ACUT |
| MAX40010FAWT+* | 50 | -40°C to +125°C | 6 WLP | +DV |
| MAX40010HAUT+* | 100 | -40°C to +125°C | 6 SOT23 | +ACUU |
| MAX40010HAWT+* | 100 | -40°C to +125°C | 6 WLP | +DW |

*Future Product—Contact factory for availability.

+Denotes a lead(Pb)-free/RoHS-compliant package.

Package Information

For the latest package outline information and land patterns (footprints), go to www.maximintegrated.com/packages. Note that a "+", "#", or "-" in the package code indicates RoHS status only. Package drawings may show a different suffix character, but the drawing pertains to the package regardless of RoHS status.

| PACKAGE TYPE | PACKAGE CODE | OUTLINE NO. | LAND PATTERN NO. |
|--------------|--------------|---------------------------|------------------------------------------------|
| 6 WLP | W61K1+1 | 21-100121 | Refer to Application Note 1891 |
| 6 SOT23 | U6SN+1 | 21-0058 | 91-0175 |

Revision History

| REVISION NUMBER | REVISION DATE | DESCRIPTION | PAGES CHANGED |
|-----------------|---------------|-----------------|---------------|
| 0 | 10/16 | Initial release | — |

For pricing, delivery, and ordering information, please contact Maxim Direct at 1-888-629-4642, or visit Maxim Integrated's website at www.maximintegrated.com.

Maxim Integrated cannot assume responsibility for use of any circuitry other than circuitry entirely embodied in a Maxim Integrated product. No circuit patent licenses are implied. Maxim Integrated reserves the right to change the circuitry and specifications without notice at any time. The parametric values (min and max limits) shown in the Electrical Characteristics table are guaranteed. Other parametric values quoted in this data sheet are provided for guidance.

Данный компонент на территории Российской Федерации

Вы можете приобрести в компании MosChip.

Для оперативного оформления запроса Вам необходимо перейти по данной ссылке:

<http://moschip.ru/get-element>

Вы можете разместить у нас заказ для любого Вашего проекта, будь то серийное производство или разработка единичного прибора.

В нашем ассортименте представлены ведущие мировые производители активных и пассивных электронных компонентов.

Нашей специализацией является поставка электронной компонентной базы двойного назначения, продукции таких производителей как XILINX, Intel (ex.ALTERA), Vicor, Microchip, Texas Instruments, Analog Devices, Mini-Circuits, Amphenol, Glenair.

Сотрудничество с глобальными дистрибьюторами электронных компонентов, предоставляет возможность заказывать и получать с международных складов практически любой перечень компонентов в оптимальные для Вас сроки.

На всех этапах разработки и производства наши партнеры могут получить квалифицированную поддержку опытных инженеров.

Система менеджмента качества компании отвечает требованиям в соответствии с ГОСТ Р ИСО 9001, ГОСТ РВ 0015-002 и ЭС РД 009

Офис по работе с юридическими лицами:

105318, г.Москва, ул.Щербаковская д.3, офис 1107, 1118, ДЦ «Щербаковский»

Телефон: +7 495 668-12-70 (многоканальный)

Факс: +7 495 668-12-70 (доб.304)

E-mail: info@moschip.ru

Skype отдела продаж:

moschip.ru

moschip.ru_4

moschip.ru_6

moschip.ru_9