

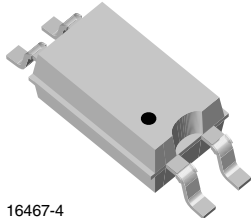

Optocoupler, Phototransistor Output, AC Input, Low Input Current, SSOP-4, Half Pitch, Mini-Flat Package

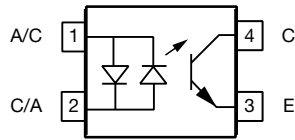

16467-4



FEATURES

- High CTR with low input current
- Low profile package (half pitch)
- High collector emitter voltage, $V_{CE0} = 80\text{ V}$
- Isolation test voltage, 3750 V_{RMS}
- Low coupling capacitance
- High common mode transient immunity
- Compliant to RoHS Directive 2002/95/EC and in accordance to WEEE 2002/96/EC



RoHS COMPLIANT

DESCRIPTION

The VOS628A series has a GaAs infrared emitting diode emitter, which is optically coupled to a silicon planar phototransistor detector, and is incorporated in a 4-pin 50 mil lead pitch mini-flat package.

It features a high current transfer ratio at low input current, low coupling capacitance, and high isolation voltage.

The coupling devices are designed for signal transmission between two electrically separated circuits.

APPLICATIONS

- Telecom
- Industrial controls
- Battery powered equipment
- Office machines
- Programmable controllers

AGENCY APPROVALS

- UL1577, file no. E76222 system code M, double protection (pending)
- cUL CSA 22.2 bulletin 5A, double protection (pending)
- DIN EN 60747-5-2 (pending) (VDE 0884)/DIN EN 60747-5-5 available with option 1
- BSI: EN 60065:2002 (pending), EN 60950-1:2006 (pending)
- FIMKO

ORDERING INFORMATION			
V	O	S	6
2	8	A	-
#	X	0	0
1	T		
PART NUMBER			CTR BIN
		PACKAGE OPTION	TAPE AND REEL
			SSOP-#
			7 mm
AGENCY CERTIFIED/PACKAGE	CTR (%)		
	± 1 mA		
UL, cUL, BSI	63 to 125	100 to 200	160 to 320
SSOP-4, 50 mil pitch	VOS628A-2T	VOS628A-3T	VOS628A-4T
UL, cUL, BSI, VDE	63 to 125	100 to 200	160 to 320
SSOP-4, 50 mil pitch	-	VOS628A-3X001T	-

Note

- Additional options may be possible, please contact sales office.



ABSOLUTE MAXIMUM RATINGS ($T_{amb} = 25\text{ }^{\circ}\text{C}$, unless otherwise specified)				
PARAMETER	TEST CONDITION	SYMBOL	VALUE	UNIT
INPUT				
Power dissipation		P_{diss}	100	mW
Forward current		I_F	60	mA
OUTPUT				
Collector emitter voltage		V_{CE}	80	V
Emitter collector voltage		V_{EC}	7	V
Collector current		I_C	50	mA
	$t_p/T = 0.5$, $t_p < 10\text{ ms}$	I_C	100	mA
Power dissipation		P_{diss}	150	mW
COUPLER				
Isolation test voltage between emitter and detector		V_{ISO}	3750	V_{RMS}
Isolation resistance	$V_{IO} = 500\text{ V}$, $T_{amb} = 25\text{ }^{\circ}\text{C}$	R_{IO}	$\geq 10^{12}$	Ω
	$V_{IO} = 500\text{ V}$, $T_{amb} = 100\text{ }^{\circ}\text{C}$	R_{IO}	$\geq 10^{11}$	Ω
Storage temperature range		T_{stg}	- 40 to + 125	$^{\circ}\text{C}$
Ambient temperature range		T_{amb}	- 40 to + 110	$^{\circ}\text{C}$
Junction temperature		T_j	125	$^{\circ}\text{C}$
Soldering temperature ⁽¹⁾	max. 10 s, dip soldering distance to seating plane $\geq 1.5\text{ mm}$	T_{sld}	260	$^{\circ}\text{C}$

Notes

- Stresses in excess of the absolute maximum ratings can cause permanent damage to the device. Functional operation of the device is not implied at these or any other conditions in excess of those given in the operational sections of this document. Exposure to absolute maximum ratings for extended periods of the time can adversely affect reliability.
- ⁽¹⁾ Refer to reflow profile for soldering conditions for surface mounted devices.

ELECTRICAL CHARACTERISTICS ($T_{amb} = 25\text{ }^{\circ}\text{C}$, unless otherwise specified)							
PARAMETER	TEST CONDITION	PART	SYMBOL	MIN.	TYP.	MAX.	UNIT
INPUT							
Forward voltage	$I_F = \pm 5\text{ mA}$		V_F		1.16	1.5	V
Capacitance	$V_R = 0\text{ V}$, $f = 1\text{ MHz}$		C_O		25		pF
OUTPUT							
Collector emitter leakage current	$V_{CE} = 10\text{ V}$		I_{CEO}		10	200	nA
Collector emitter capacitance	$V_{CE} = 5\text{ V}$, $f = 1\text{ MHz}$		C_{CE}		7		pF
COUPLER							
Collector emitter saturation voltage	$I_C = 0.32\text{ mA}$, $I_F = \pm 1\text{ mA}$	VOS628A-2	V_{CEsat}		0.25	0.4	V
	$I_C = 0.5\text{ mA}$, $I_F = \pm 1\text{ mA}$	VOS628A-3	V_{CEsat}		0.25	0.4	V
	$I_C = 0.8\text{ mA}$, $I_F = \pm 1\text{ mA}$	VOS628A-4	V_{CEsat}		0.25	0.4	V
Coupling capacitance			C_C		0.25		pF

Note

- Minimum and maximum values are testing requirements. Typical values are characteristics of the device and are the result of engineering evaluation. Typical values are for information only and are not part of the testing requirements.

CURRENT TRANSFER RATIO ($T_{amb} = 25\text{ }^{\circ}\text{C}$, unless otherwise specified)							
PARAMETER	TEST CONDITION	PART	SYMBOL	MIN.	TYP.	MAX.	UNIT
I_C/I_F	$I_F = \pm 1\text{ mA}$, $V_{CE} = 5\text{ V}$	VOS628A-2	CTR	63		125	%
		VOS628A-3	CTR	100		200	%
		VOS628A-4	CTR	160		320	%

SWITCHING CHARACTERISTICS ($T_{amb} = 25\text{ }^{\circ}\text{C}$, unless otherwise specified)						
PARAMETER	TEST CONDITION	SYMBOL	MIN.	TYP.	MAX.	UNIT
Turn on time	$V_{CC} = 5\text{ V}$, $I_C = 2\text{ mA}$, $R_L = 100\text{ }\Omega$	t_{on}		6		μs
Rise time	$V_{CC} = 5\text{ V}$, $I_C = 2\text{ mA}$, $R_L = 100\text{ }\Omega$	t_r		3.5		μs
Turn off time	$V_{CC} = 5\text{ V}$, $I_C = 2\text{ mA}$, $R_L = 100\text{ }\Omega$	t_{off}		5.5		μs
Fall time	$V_{CC} = 5\text{ V}$, $I_C = 2\text{ mA}$, $R_L = 100\text{ }\Omega$	t_f		5		μs

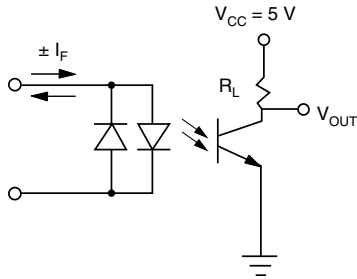

Fig. 1 - Test Circuit

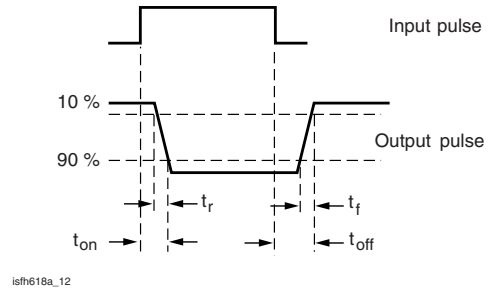

Fig. 2 - Test Circuit and Waveforms

SAFETY AND INSULATION RATINGS						
PARAMETER	TEST CONDITION	SYMBOL	MIN.	TYP.	MAX.	UNIT
Climatic classification (according to IEC 68 part 1)				40/110/21		
Comparative tracking index		CTI	175		399	
V_{IOTM}			6000			V_{peak}
V_{IORM}			707			V_{peak}
P_{SO}					265	mW
I_{SI}					130	mA
T_{SI}					150	$^{\circ}\text{C}$
Creepage distance			5			mm
Clearance distance			5			mm
Insulation thickness	Reinforce rated, per IEC 60950 2.10.5.1		0.4			mm

Note

- As per IEC 60747-5-2, §7.4.3.8.1, this optocoupler is suitable for “safe electrical insulation” only within the safety ratings. Compliance with the safety ratings shall be ensured by means of protective circuits.

TYPICAL CHARACTERISTICS ($T_{amb} = 25\text{ }^{\circ}\text{C}$, unless otherwise specified)

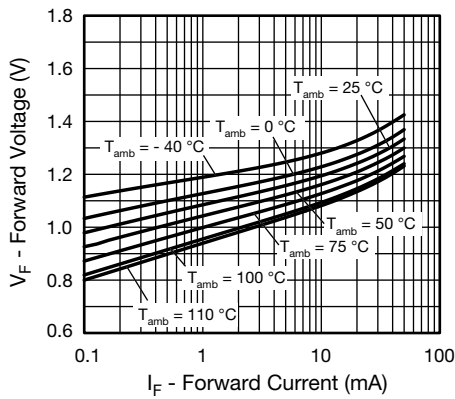

Fig. 3 - Forward Voltage vs. Forward Current

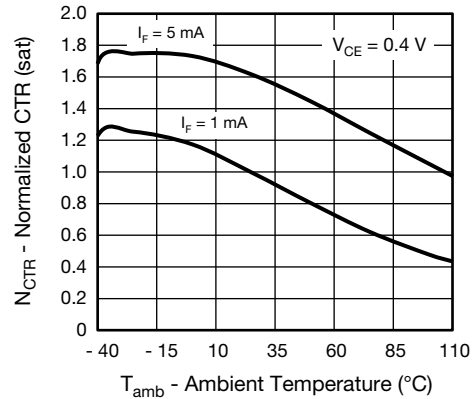

Fig. 6 - Normalized CTR (sat) vs. Ambient Temperature

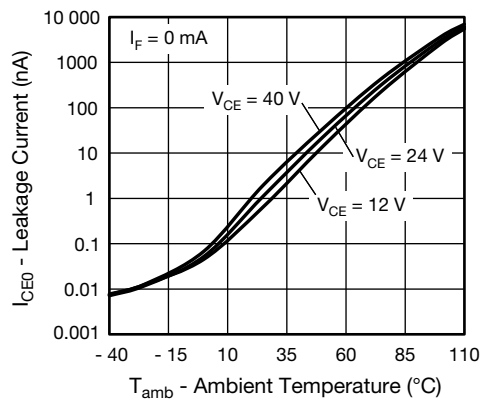

Fig. 4 - Leakage Current vs. Ambient Temperature

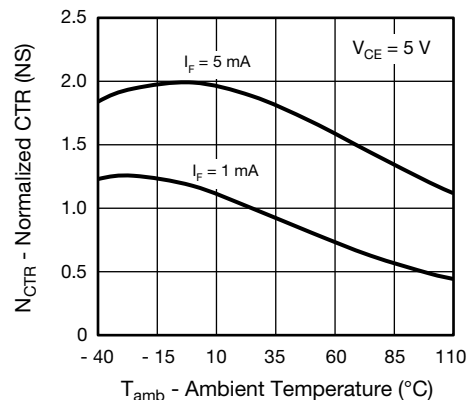

Fig. 7 - Normalized CTR (NS) vs. Ambient Temperature

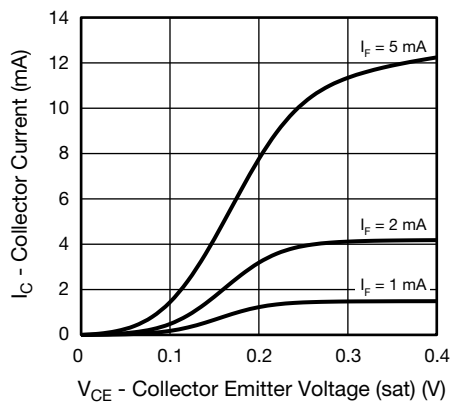

Fig. 5 - Collector Current vs. Collector Emitter Voltage (sat)

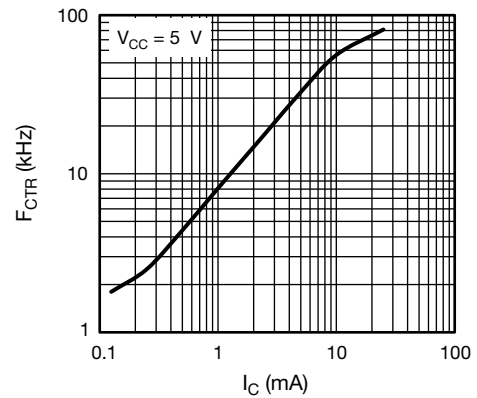

Fig. 8 - F_{CTR} vs. I_C

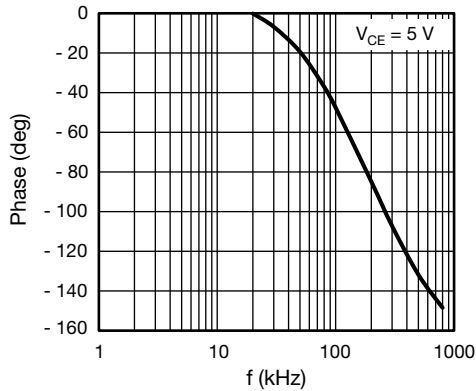
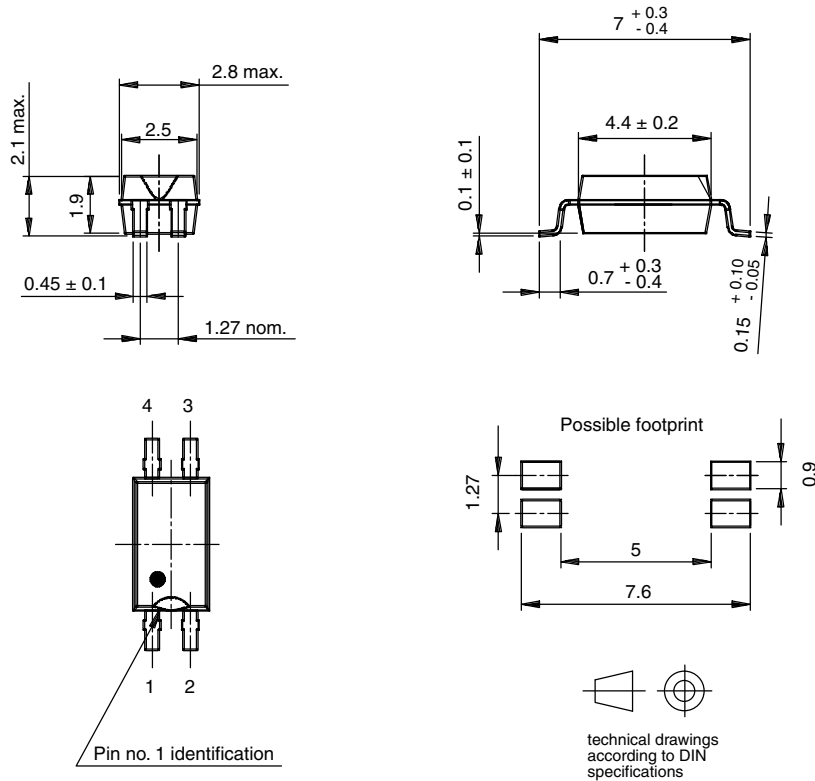

Fig. 9 - F_{CTR} vs. Phase Angle

PACKAGE DIMENSIONS in millimeters



16283

PACKAGE MARKING (example)

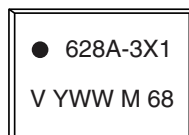

Notes

- Only option 1 is reflected in the package marking, it is indicated by the characters "X1".
- Tape and reel suffix (T) is not part of the package marking.



Disclaimer

ALL PRODUCT, PRODUCT SPECIFICATIONS AND DATA ARE SUBJECT TO CHANGE WITHOUT NOTICE TO IMPROVE RELIABILITY, FUNCTION OR DESIGN OR OTHERWISE.

Vishay Intertechnology, Inc., its affiliates, agents, and employees, and all persons acting on its or their behalf (collectively, "Vishay"), disclaim any and all liability for any errors, inaccuracies or incompleteness contained in any datasheet or in any other disclosure relating to any product.

Vishay makes no warranty, representation or guarantee regarding the suitability of the products for any particular purpose or the continuing production of any product. To the maximum extent permitted by applicable law, Vishay disclaims (i) any and all liability arising out of the application or use of any product, (ii) any and all liability, including without limitation special, consequential or incidental damages, and (iii) any and all implied warranties, including warranties of fitness for particular purpose, non-infringement and merchantability.

Statements regarding the suitability of products for certain types of applications are based on Vishay's knowledge of typical requirements that are often placed on Vishay products in generic applications. Such statements are not binding statements about the suitability of products for a particular application. It is the customer's responsibility to validate that a particular product with the properties described in the product specification is suitable for use in a particular application. Parameters provided in datasheets and/or specifications may vary in different applications and performance may vary over time. All operating parameters, including typical parameters, must be validated for each customer application by the customer's technical experts. Product specifications do not expand or otherwise modify Vishay's terms and conditions of purchase, including but not limited to the warranty expressed therein.

Except as expressly indicated in writing, Vishay products are not designed for use in medical, life-saving, or life-sustaining applications or for any other application in which the failure of the Vishay product could result in personal injury or death. Customers using or selling Vishay products not expressly indicated for use in such applications do so at their own risk and agree to fully indemnify and hold Vishay and its distributors harmless from and against any and all claims, liabilities, expenses and damages arising or resulting in connection with such use or sale, including attorneys fees, even if such claim alleges that Vishay or its distributor was negligent regarding the design or manufacture of the part. Please contact authorized Vishay personnel to obtain written terms and conditions regarding products designed for such applications.

No license, express or implied, by estoppel or otherwise, to any intellectual property rights is granted by this document or by any conduct of Vishay. Product names and markings noted herein may be trademarks of their respective owners.

Данный компонент на территории Российской Федерации

Вы можете приобрести в компании MosChip.

Для оперативного оформления запроса Вам необходимо перейти по данной ссылке:

<http://moschip.ru/get-element>

Вы можете разместить у нас заказ для любого Вашего проекта, будь то серийное производство или разработка единичного прибора.

В нашем ассортименте представлены ведущие мировые производители активных и пассивных электронных компонентов.

Нашей специализацией является поставка электронной компонентной базы двойного назначения, продукции таких производителей как XILINX, Intel (ex.ALTERA), Vicor, Microchip, Texas Instruments, Analog Devices, Mini-Circuits, Amphenol, Glenair.

Сотрудничество с глобальными дистрибьюторами электронных компонентов, предоставляет возможность заказывать и получать с международных складов практически любой перечень компонентов в оптимальные для Вас сроки.

На всех этапах разработки и производства наши партнеры могут получить квалифицированную поддержку опытных инженеров.

Система менеджмента качества компании отвечает требованиям в соответствии с ГОСТ Р ИСО 9001, ГОСТ РВ 0015-002 и ЭС РД 009

Офис по работе с юридическими лицами:

105318, г.Москва, ул.Щербаковская д.3, офис 1107, 1118, ДЦ «Щербаковский»

Телефон: +7 495 668-12-70 (многоканальный)

Факс: +7 495 668-12-70 (доб.304)

E-mail: info@moschip.ru

Skype отдела продаж:

moschip.ru

moschip.ru_4

moschip.ru_6

moschip.ru_9