

ANGELA-S-B

~10° spot beam compatible with BJB connectors

TECHNICAL SPECIFICATIONS:

Dimensions	Ø 119.5 mm
Height	74.5 mm
Fastening	socket
ROHS compliant	yes ⓘ

MATERIAL SPECIFICATIONS:

Component	Type	Material	Colour	Finish	Coating
ANGELA-S-B	Reflector	PC	metal		HMDS



ORDERING INFORMATION:

Component	Qty in box	MOQ	MPQ	Box weight (kg)
F13662_ANGELA-S-B » Box size: 398 x 298 x 265 mm	180	90	45	8.6

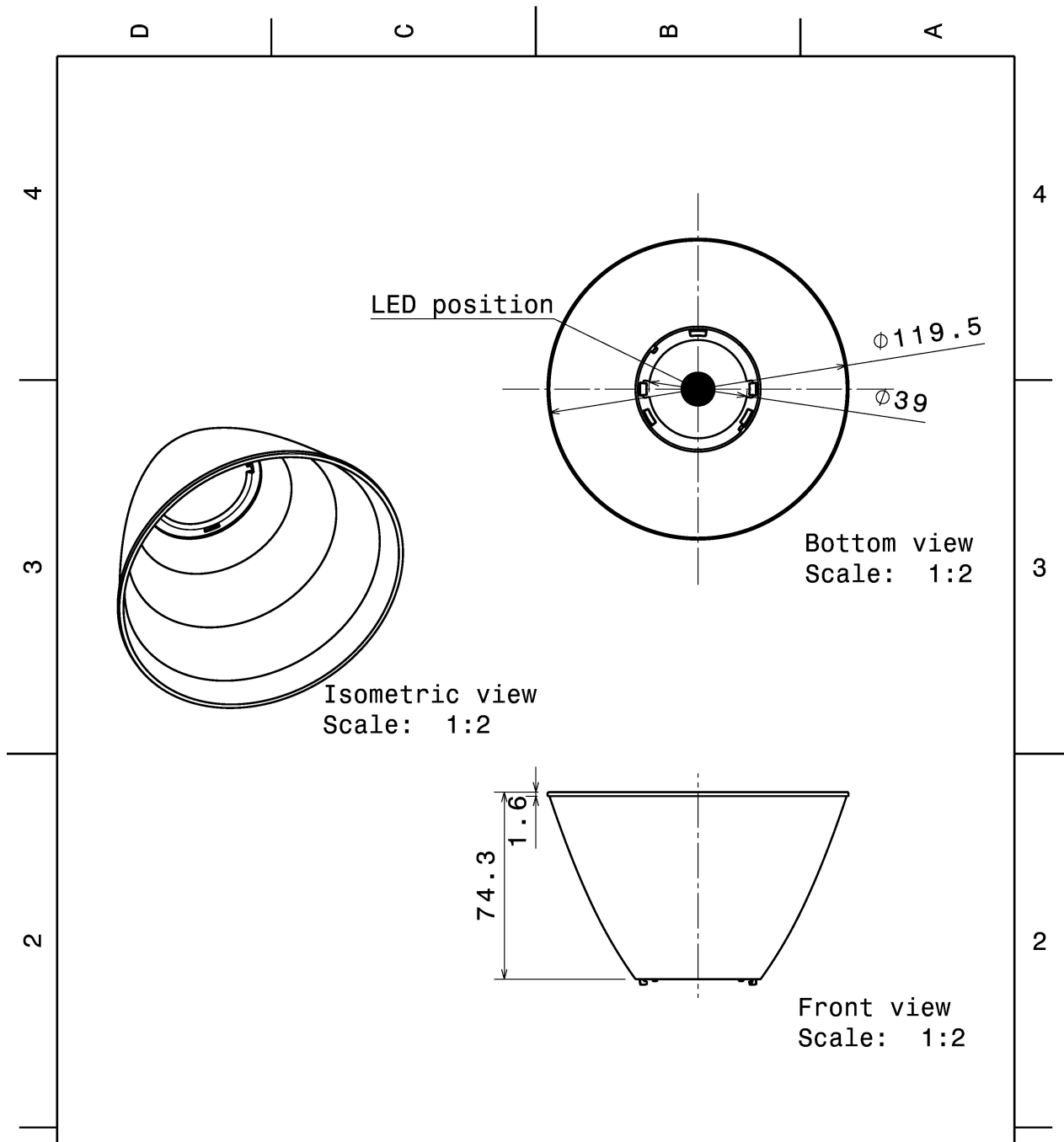

Tolerances if not otherwise shown
According to DIN ISO 2768-1
Linear measures:
Up to 30mm class M, otherwise class C.
According to DIN ISO 2768-2
Form and position: class L

LEDiL

Ledil Oy
Salorankatu 10
FIN 24240 SALO
Finland

THIRD ANGLE PROJECTION:

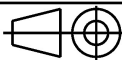

DRAWING TITLE

Angela-B

This drawing is the property
of LEDiL Oy. It may not be
reproduced, copied or
communicated without a written
agreement with LEDiL Oy."

SIZE PART NUMBER

A4



-

SCALE 1:2 WEIGHT





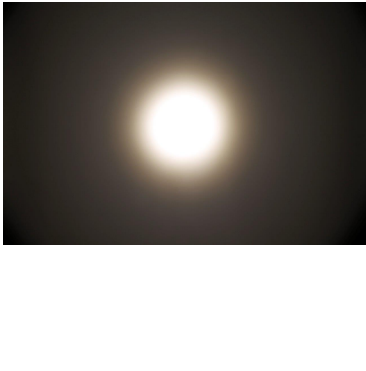
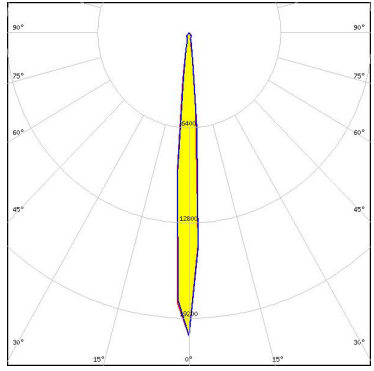
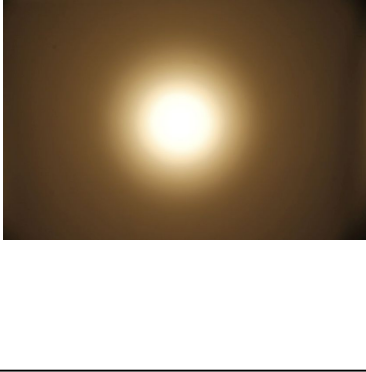
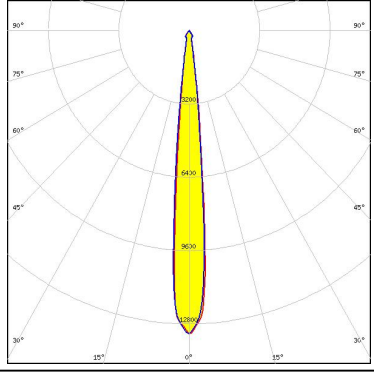
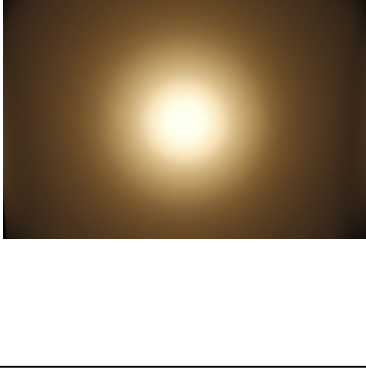
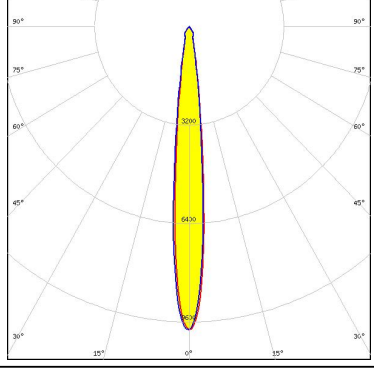

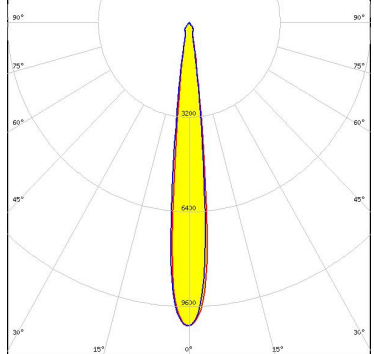
-

SHEET 1/1

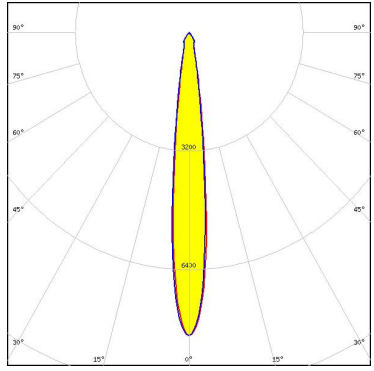
PHOTOMETRIC DATA (MEASURED):

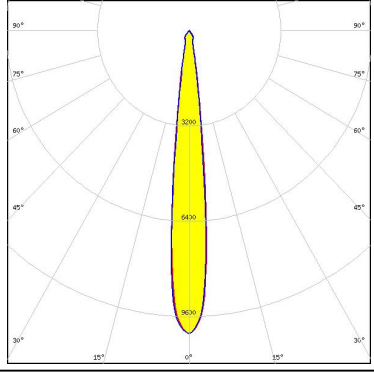
<p>bridgelux.</p> <p>LED BXRA ES Rectangle</p> <p>FWHM 8.0°</p> <p>Efficiency 94 %</p> <p>Peak intensity 20.7 cd/Im</p> <p>LEDs/each optic 1</p> <p>Light colour White</p> <p>Required components: BJB: 47.319.2040</p>		
<p>bridgelux.</p> <p>LED V15 Gen6</p> <p>FWHM 11.0°</p> <p>Efficiency 89 %</p> <p>Peak intensity 13 cd/Im</p> <p>LEDs/each optic 1</p> <p>Light colour White</p> <p>Required components: BJB: 47.319.2224</p>		
<p>bridgelux.</p> <p>LED V15 Gen6</p> <p>FWHM 11.0°</p> <p>Efficiency 86 %</p> <p>Peak intensity 9.9 cd/Im</p> <p>LEDs/each optic 1</p> <p>Light colour White</p> <p>Required components: F13671_ANGE-RZ-LENS BJB: 47.319.2274</p>		
<p>bridgelux.</p> <p>LED V18 Gen6</p> <p>FWHM 12.0°</p> <p>Efficiency 89 %</p> <p>Peak intensity 10 cd/Im</p> <p>LEDs/each optic 1</p> <p>Light colour White</p> <p>Required components: BJB: 47.319.2274</p>		

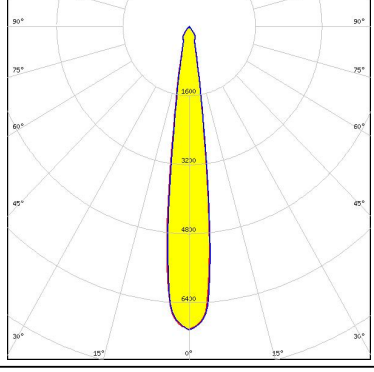
PHOTOMETRIC DATA (MEASURED):

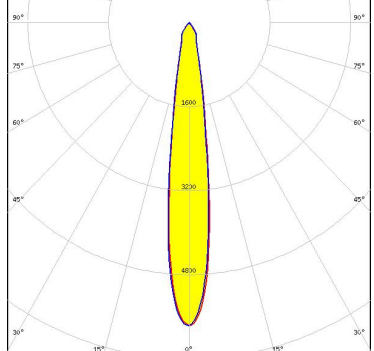
<p>bridgelux.</p> <p>LED V18 Gen6</p> <p>FWHM 13.0°</p> <p>Efficiency 86 %</p> <p>Peak intensity 8.2 cd/lm</p> <p>LEDs/each optic 1</p> <p>Light colour White</p> <p>Required components: F13671_ANGE-RZ-LENS BJB: 47.319.2274</p>		
<p>bridgelux.</p> <p>LED V18 Gen7</p> <p>FWHM 12.0°</p> <p>Efficiency 91 %</p> <p>Peak intensity 10.2 cd/lm</p> <p>LEDs/each optic 1</p> <p>Light colour White</p> <p>Required components: BJB: 47.319.2350</p>		
<p>bridgelux.</p> <p>LED V22 Gen6</p> <p>FWHM 15.0°</p> <p>Efficiency 88 %</p> <p>Peak intensity 7 cd/lm</p> <p>LEDs/each optic 1</p> <p>Light colour White</p> <p>Required components: A.A.G. STUCCHI: 8102/G2</p>		
<p>bridgelux.</p> <p>LED V22 Gen6</p> <p>FWHM 15.0°</p> <p>Efficiency 84 %</p> <p>Peak intensity 5.8 cd/lm</p> <p>LEDs/each optic 1</p> <p>Light colour White</p> <p>Required components: F13671_ANGE-RZ-LENS A.A.G. STUCCHI: 8102/G2</p>		

PHOTOMETRIC DATA (MEASURED):

CITIZEN

LED CLL03x/CLU03x
 FWHM 9.0°
 Efficiency 94 %
 Peak intensity 18.3 cd/lm
 LEDs/each optic 1
 Light colour White
 Required components:
 BJB: 47.319.2021

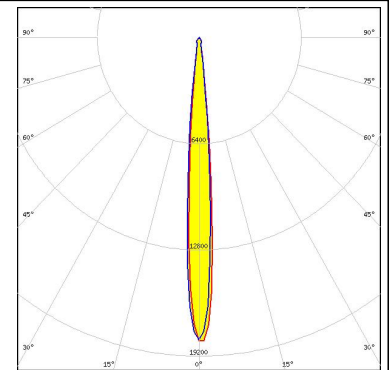

CITIZEN

LED CLL03x/CLU03x
 FWHM 10.0°
 Efficiency 86 %
 Peak intensity 10.8 cd/lm
 LEDs/each optic 1
 Light colour White
 Required components:
 F13671_ANGE-RZ-LENS
 A.A.G. STUCCHI: 8101/G2

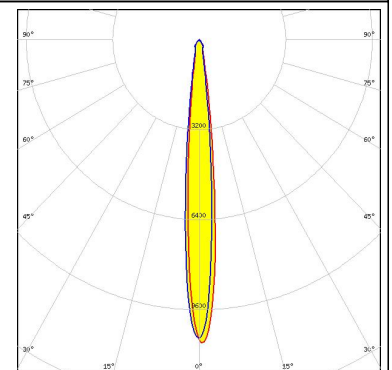
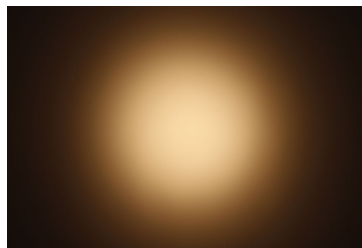

CITIZEN

LED CLL03x/CLU03x
 FWHM 10.0°
 Efficiency 93 %
 Peak intensity 15.4 cd/lm
 LEDs/each optic 1
 Light colour White
 Required components:
 A.A.G. STUCCHI: 8101/G2

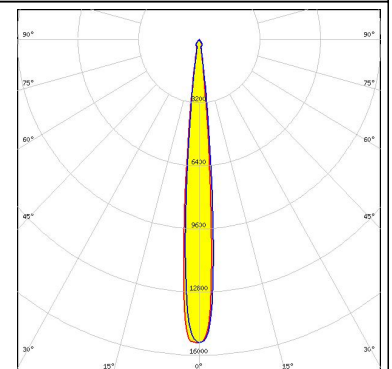
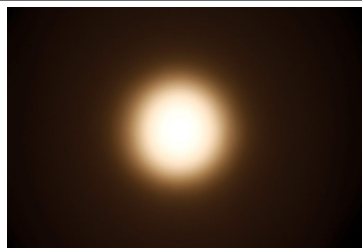

CITIZEN

LED CLL04x/CLU04x
 FWHM 15.0°
 Efficiency 92 %
 Peak intensity 7.3 cd/lm
 LEDs/each optic 1
 Light colour White
 Required components:
 BJB: 47.319.2030

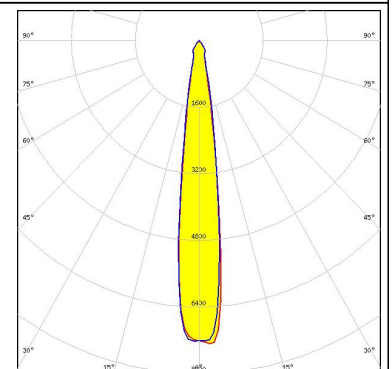
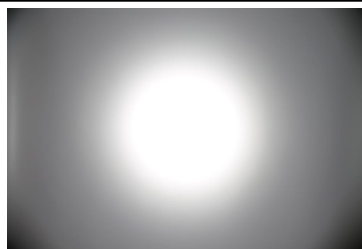

PHOTOMETRIC DATA (MEASURED):

CITIZEN

LED CLL04x/CLU04x
 FWHM 15.0°
 Efficiency 86 %
 Peak intensity 5.9 cd/lm
 LEDs/each optic 1
 Light colour White
 Required components:
 F13671_ANGE-RZ-LENS
 A.A.G. STUCCHI: 8102/G2

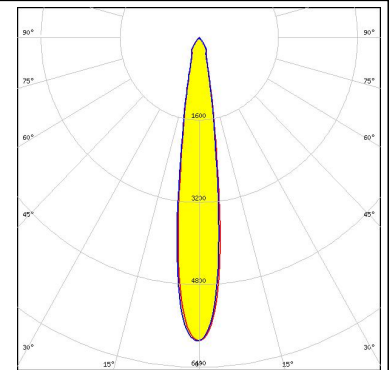
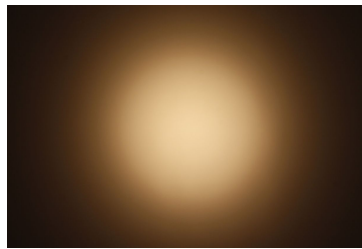

CITIZEN

LED CLL04x/CLU04x
 FWHM 15.0°
 Efficiency 92 %
 Peak intensity 6.9 cd/lm
 LEDs/each optic 1
 Light colour White
 Required components:
 A.A.G. STUCCHI: 8102/G2

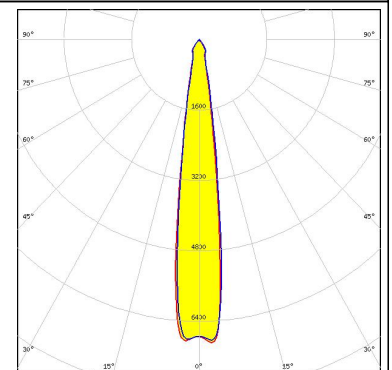
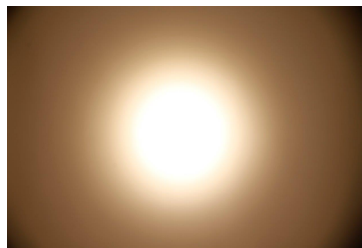

CITIZEN

LED CLU720/721
 FWHM 7.0°
 Efficiency 94 %
 Peak intensity 25 cd/lm
 LEDs/each optic 1
 Light colour White
 Required components:
 A.A.G. STUCCHI: 8101/G2

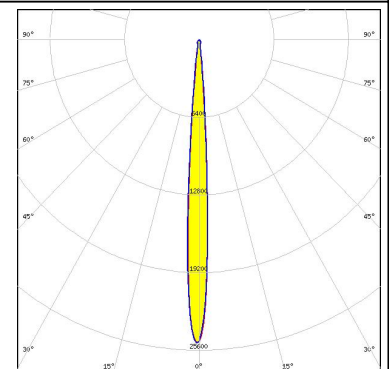
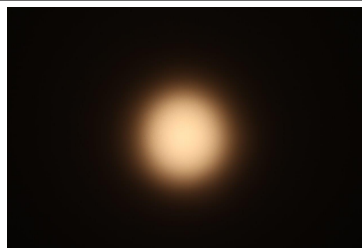

CITIZEN

LED CLU720/721
 FWHM 7.0°
 Efficiency 94 %
 Peak intensity 25.3 cd/lm
 LEDs/each optic 1
 Light colour White
 Required components:
 BJB: 47.319.2021

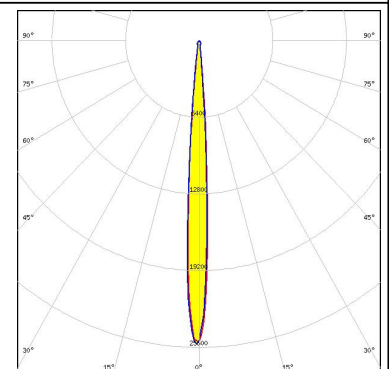
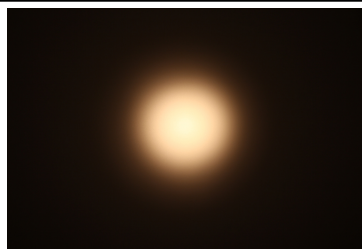

PHOTOMETRIC DATA (MEASURED):



LED CXA/B 25xx
 FWHM 13.0°
 Efficiency 86 %
 Peak intensity 7.5 cd/lm
 LEDs/each optic 1
 Light colour White
 Required components:
 F13671_ANGE-RZ-LENS
 BJB: 47.319.2141

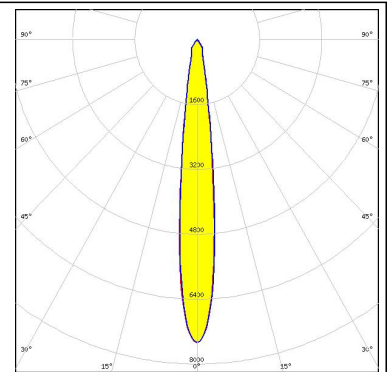

LED CXA/B 25xx
 FWHM 11.0°
 Efficiency 92 %
 Peak intensity 11.6 cd/lm
 LEDs/each optic 1
 Light colour White
 Required components:
 A.A.G. STUCCHI: 8401/G2

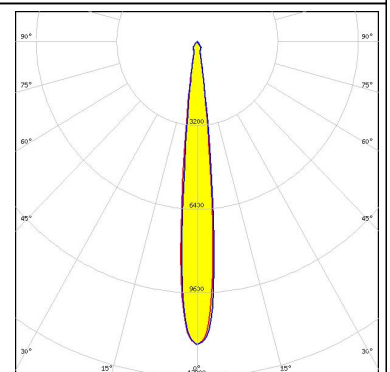
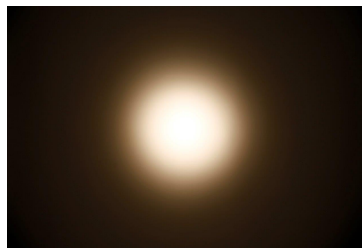

LED CXA/B 25xx
 FWHM 13.0°
 Efficiency 89 %
 Peak intensity 9.3 cd/lm
 LEDs/each optic 1
 Light colour White
 Required components:
 BJB: 47.319.2141

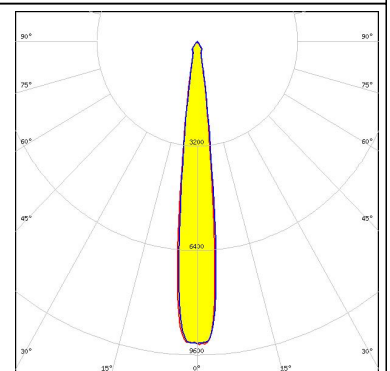
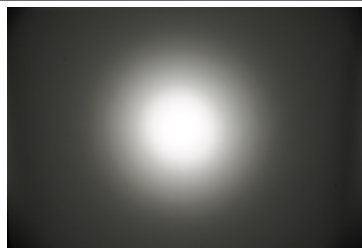

LED CXA/B 30xx
 FWHM 15.0°
 Efficiency 91 %
 Peak intensity 7.2 cd/lm
 LEDs/each optic 1
 Light colour White
 Required components:
 A.A.G. STUCCHI: 8404/G2

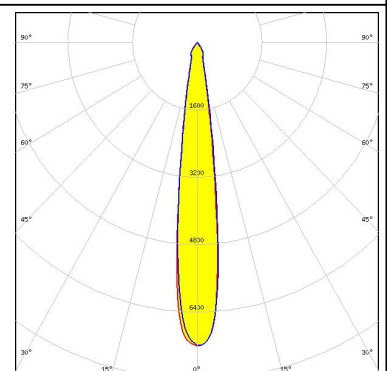
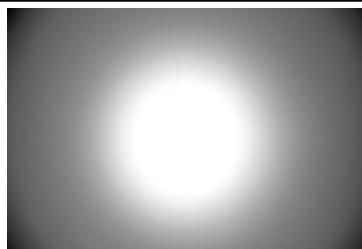

PHOTOMETRIC DATA (MEASURED):

LG Innotek

LED COB 10W/13W/17W/24W
 FWHM 8.0°
 Efficiency 94 %
 Peak intensity 16.2 cd/lm
 LEDs/each optic 1
 Light colour White
 Required components:
 BJB: 47.319.2080

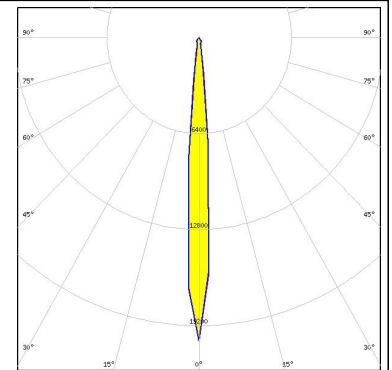

LG Innotek

LED COB 10W/13W/17W/24W
 FWHM 9.0°
 Efficiency 93 %
 Peak intensity 19.2 cd/lm
 LEDs/each optic 1
 Light colour White
 Required components:
 A.A.G. STUCCHI: 8600/G2

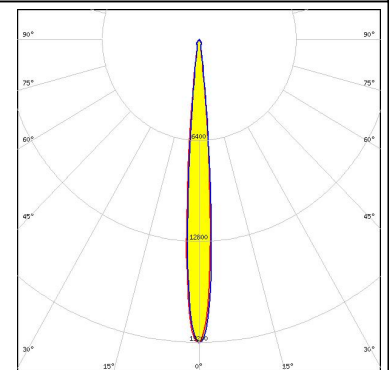
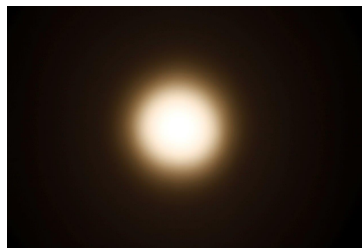

LG Innotek

LED COB 40W/60W
 FWHM 15.0°
 Efficiency 91 %
 Peak intensity 6.8 cd/lm
 LEDs/each optic 1
 Light colour White
 Required components:
 A.A.G. STUCCHI: 8102/G2

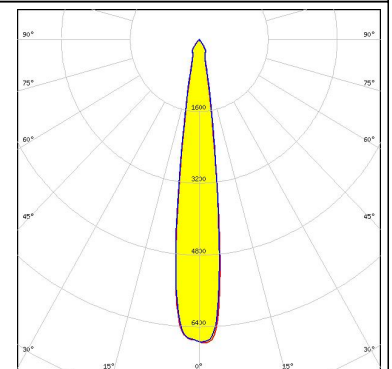
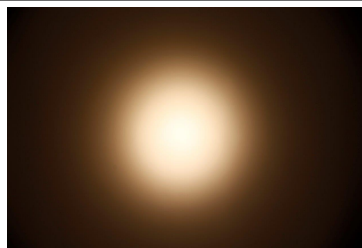

LUMILEDS

LED LUXEON CoB 1204/1205
 FWHM 9.0°
 Efficiency 93 %
 Peak intensity 19.2 cd/lm
 LEDs/each optic 1
 Light colour White
 Required components:
 A.A.G. STUCCHI: 8301/G2

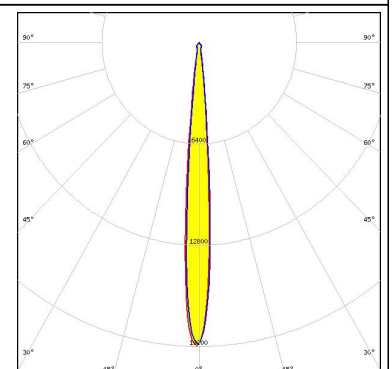

PHOTOMETRIC DATA (MEASURED):

LUMILEDS

LED LUXEON CoB 1208
 FWHM 11.0°
 Efficiency 86 %
 Peak intensity 10 cd/lm
 LEDs/each optic 1
 Light colour White
 Required components:
 F13671_ANGE-RZ-LENS
 A.A.G. STUCCHI: 8301/G2

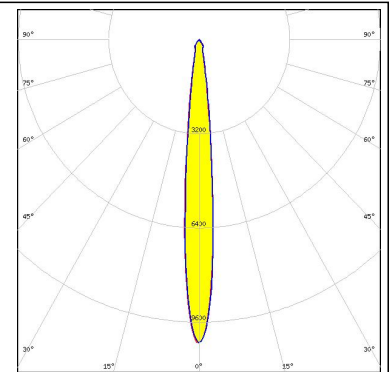

LUMILEDS

LED LUXEON CoB 1208
 FWHM 10.0°
 Efficiency 94 %
 Peak intensity 14.8 cd/lm
 LEDs/each optic 1
 Light colour White
 Required components:
 A.A.G. STUCCHI: 8301/G2

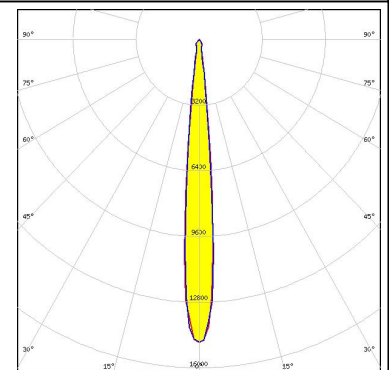
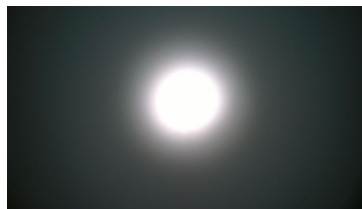

LUMILEDS

LED LUXEON CoB 1211
 FWHM 13.0°
 Efficiency 91 %
 Peak intensity 9.5 cd/lm
 LEDs/each optic 1
 Light colour White
 Required components:
 A.A.G. STUCCHI: 8102/G2

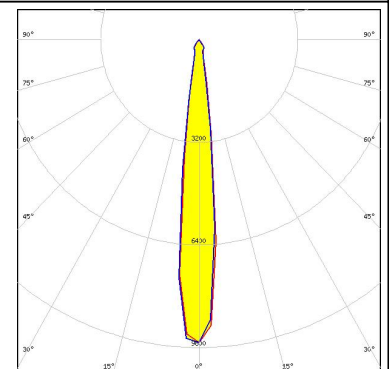

LUMILEDS

LED LUXEON CoB 1211
 FWHM 13.0°
 Efficiency 90 %
 Peak intensity 9.4 cd/lm
 LEDs/each optic 1
 Light colour White
 Required components:
 BJB: 47.319.2030

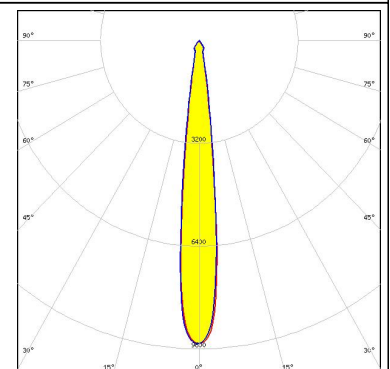

PHOTOMETRIC DATA (MEASURED):

LUMILEDS

LED LUXEON CoB 1216/1812
 FWHM 16.0°
 Efficiency 85 %
 Peak intensity 5.5 cd/lm
 LEDs/each optic 1
 Light colour White
 Required components:
 F13671_ANGE-RZ-LENS
 BJB: 47.319.2030

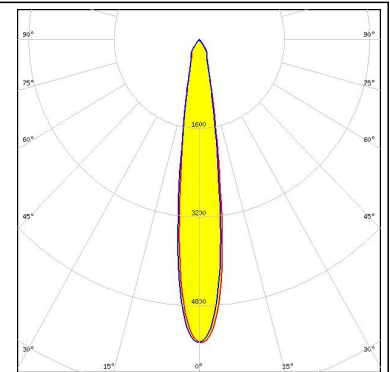

LUMILEDS

LED LUXEON CoB 1216/1812
 FWHM 15.0°
 Efficiency 89 %
 Peak intensity 6.6 cd/lm
 LEDs/each optic 1
 Light colour White
 Required components:
 BJB: 47.319.2030

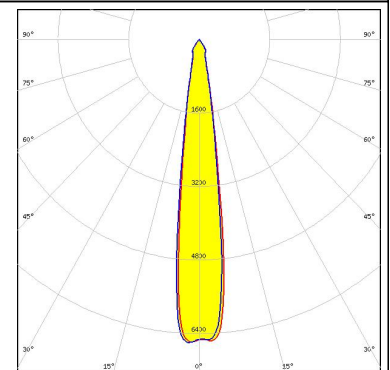

LUMILEDS

LED LUXEON K12
 FWHM 9.0°
 Efficiency 94 %
 Peak intensity 17.3 cd/lm
 LEDs/each optic 1
 Light colour White
 Required components:
 BJB: 47.319.2070

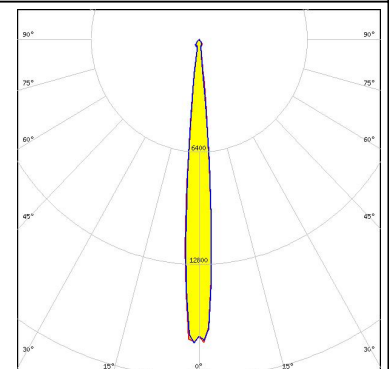

LUMILEDS

LED LUXEON K16
 FWHM 11.0°
 Efficiency 94 %
 Peak intensity 13.6 cd/lm
 LEDs/each optic 1
 Light colour White
 Required components:
 BJB: 47.319.2070

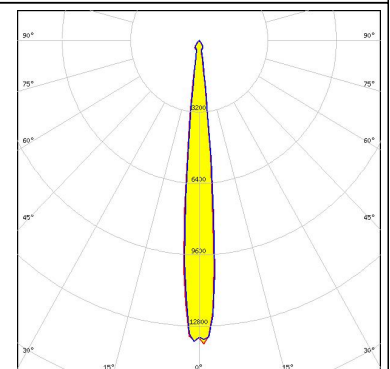
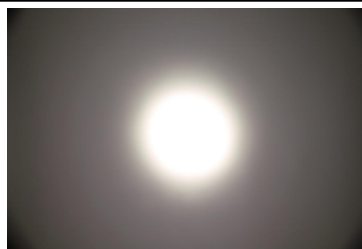

PHOTOMETRIC DATA (MEASURED):



LED CxM-14 (19x19)
 FWHM 9.0°
 Efficiency 93 %
 Peak intensity 16.3 cd/Im
 LEDs/each optic 1
 Light colour White
 Required components:
 BJB: 47.319.2021

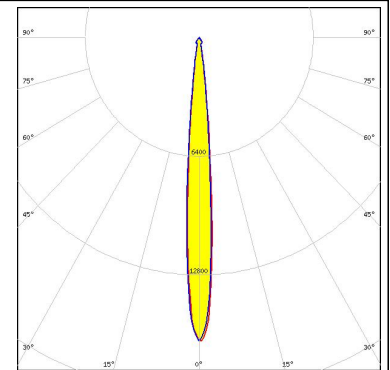
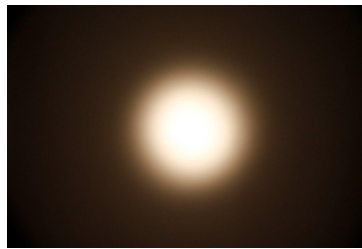

LED Soleriq S13
 FWHM 8.0°
 Efficiency 94 %
 Peak intensity 21.6 cd/Im
 LEDs/each optic 1
 Light colour White
 Required components:
 A.A.G. STUCCHI: 8502/G2

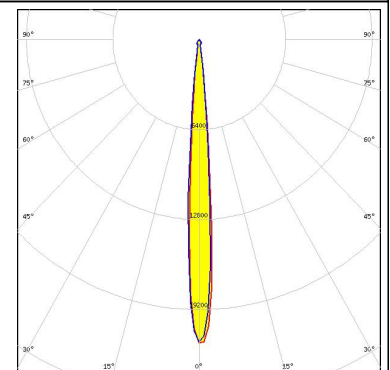

LED Soleriq S13 19x19
 FWHM 8.5°
 Efficiency 89 %
 Peak intensity 19.7 cd/Im
 LEDs/each optic 1
 Light colour White
 Required components:
 BJB: 47.319.2021

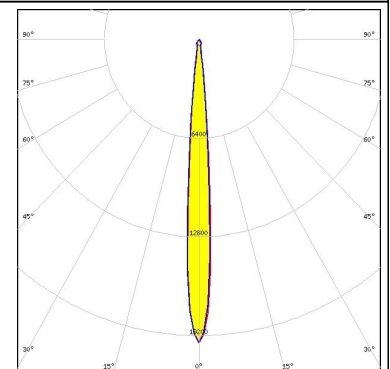
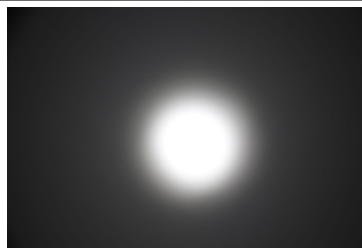

LED Soleriq S19
 FWHM 11.0°
 Efficiency 93 %
 Peak intensity 13.1 cd/Im
 LEDs/each optic 1
 Light colour White
 Required components:
 BJB: 47.319.2170

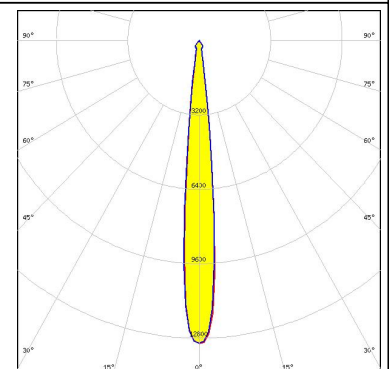
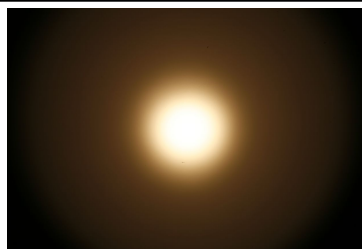

PHOTOMETRIC DATA (MEASURED):

PHILIPS

LED Fortimo SLM L19 CoB
 FWHM 13.0°
 Efficiency 86 %
 Peak intensity 7.5 cd/lm
 LEDs/each optic 1
 Light colour White
 Required components:
 F13671_ANGE-RZ-LENS
 BJB: 47.319.2030

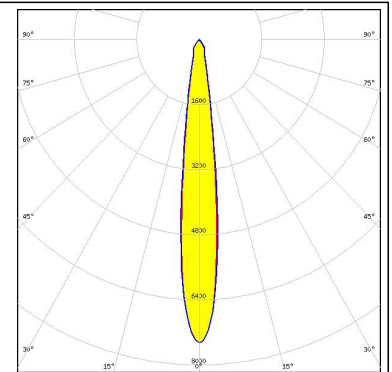

PHILIPS

LED Fortimo SLM L19 CoB
 FWHM 13.0°
 Efficiency 91 %
 Peak intensity 9.3 cd/lm
 LEDs/each optic 1
 Light colour White
 Required components:
 BJB: 47.319.2030

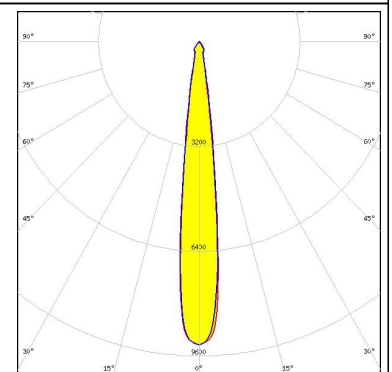

PHILIPS

LED Fortimo SLM L23 CoB
 FWHM 16.0°
 Efficiency 86 %
 Peak intensity 5.6 cd/lm
 LEDs/each optic 1
 Light colour White
 Required components:
 F13671_ANGE-RZ-LENS
 BJB: 47.319.2030

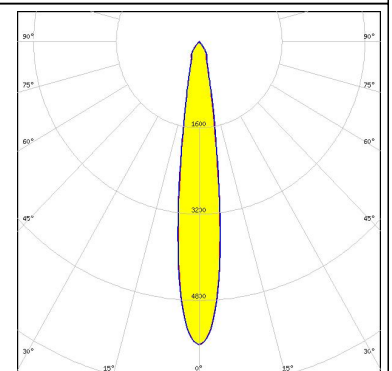
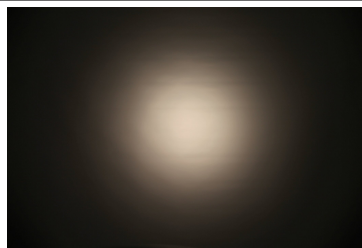

PHILIPS

LED Fortimo SLM L23 CoB
 FWHM 15.0°
 Efficiency 91 %
 Peak intensity 6.7 cd/lm
 LEDs/each optic 1
 Light colour White
 Required components:
 BJB: 47.319.2030

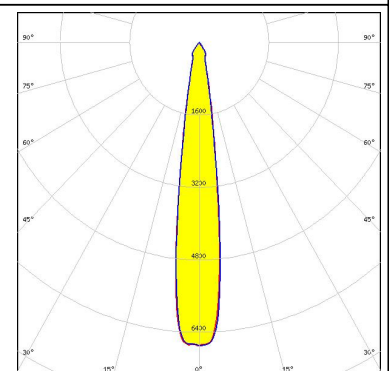

PHOTOMETRIC DATA (MEASURED):

SAMSUNG

LED LC016D / LC019D / LC026D / LC033D
 FWHM 10.0°
 Efficiency 91 %
 Peak intensity 15.2 cd/lm
 LEDs/each optic 1
 Light colour White
 Required components:
 BJB: 47.319.2021

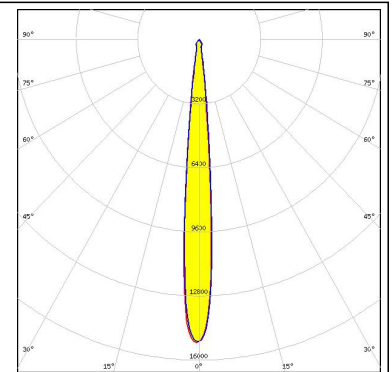

SAMSUNG

LED LC016D / LC019D / LC026D / LC033D
 FWHM 11.0°
 Efficiency 87 %
 Peak intensity 11 cd/lm
 LEDs/each optic 1
 Light colour White
 Required components:
 F13671_ANGE-RZ-LENS
 BJB: 47.319.2021

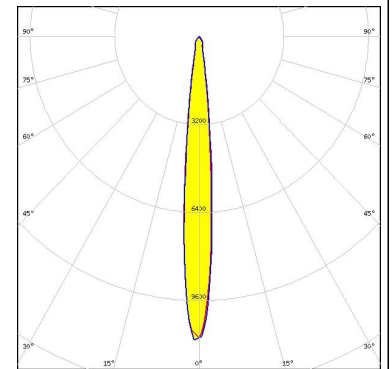

SAMSUNG

LED LC016D / LC019D / LC026D / LC033D
 FWHM 10.0°
 Efficiency 91 %
 Peak intensity 15.2 cd/lm
 LEDs/each optic 1
 Light colour White
 Required components:
 A.A.G. STUCCHI: 8101/G2

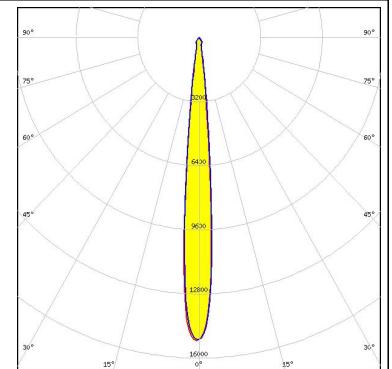
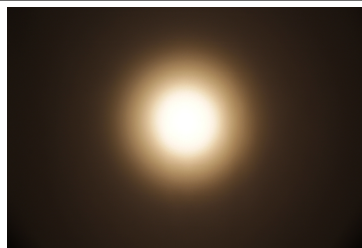





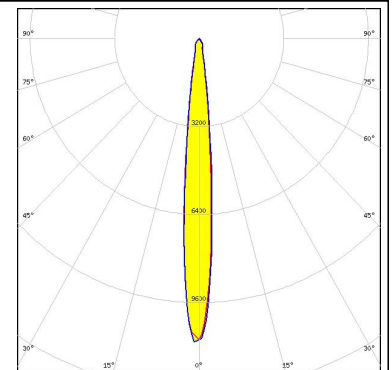

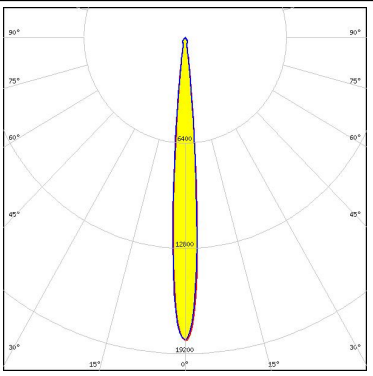

SAMSUNG

LED LC016D / LC019D / LC026D / LC033D
 FWHM 11.0°
 Efficiency 87 %
 Peak intensity 11 cd/lm
 LEDs/each optic 1
 Light colour White
 Required components:
 F13671_ANGE-RZ-LENS
 A.A.G. STUCCHI: 8101/G2

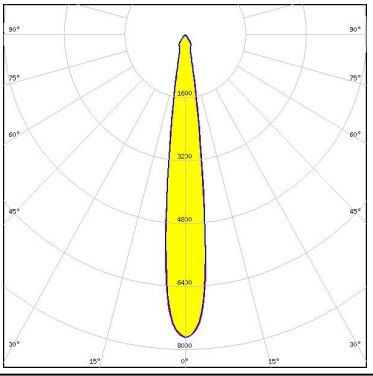

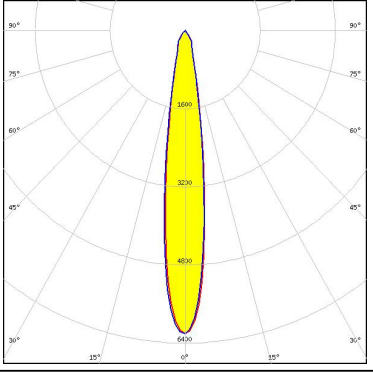
PHOTOMETRIC DATA (MEASURED):

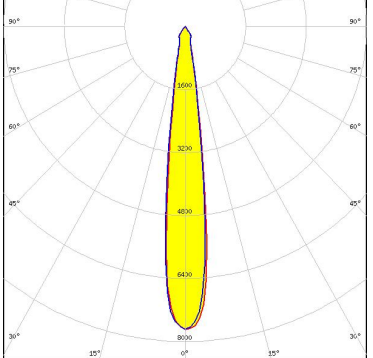
<p> SEOL SEMICONDUCTOR</p> <p>LED ZC12/18 FWHM 9.0° Efficiency 93 % Peak intensity 18.4 cd/lm LEDs/each optic 1 Light colour White Required components: A.A.G. STUCCHI: 8101/G2</p>		
<p> SEOL SEMICONDUCTOR</p> <p>LED ZC25/40/60 FWHM 14.0° Efficiency 91 % Peak intensity 7.7 cd/lm LEDs/each optic 1 Light colour White Required components: A.A.G. STUCCHI: 8102/G2</p>		
<p> SEOL SEMICONDUCTOR</p> <p>LED ZC25/40/60 FWHM 16.0° Efficiency 87 % Peak intensity 6.2 cd/lm LEDs/each optic 1 Light colour White Required components: F13671_ANGE-RZ-LENS BJB: 47.319.2030</p>		
<p> SEOL SEMICONDUCTOR</p> <p>LED ZC25/40/60 FWHM 14.0° Efficiency 93 % Peak intensity 7.7 cd/lm LEDs/each optic 1 Light colour White Required components: BJB: 47.319.2030</p>		

PHOTOMETRIC DATA (MEASURED):

SHARP

LED Mega Zenigata (GW6DME)
 FWHM 10.0°
 Efficiency 94 %
 Peak intensity 16.1 cd/Im
 LEDs/each optic 1
 Light colour White
 Required components:
 BJB: 47.319.2011

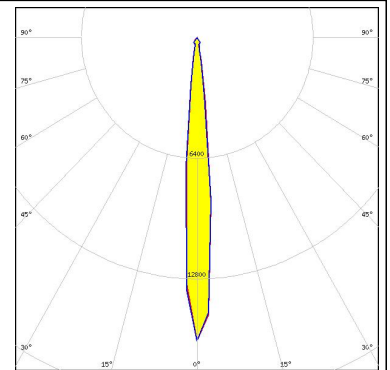

SHARP

LED Mega Zenigata (GW6DME)
 FWHM 10.0°
 Efficiency 94 %
 Peak intensity 15.5 cd/Im
 LEDs/each optic 1
 Light colour White
 Required components:
 A.A.G. STUCCHI: 8301/G2

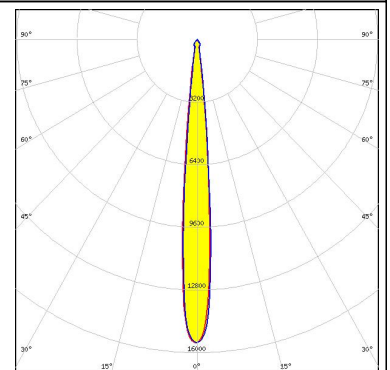
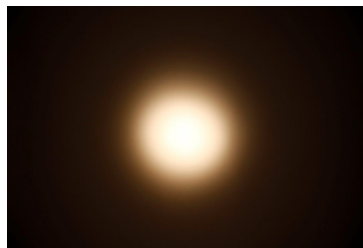

TRIDONIC

LED SLE G7 LES17 H
 FWHM 11.0°
 Efficiency 90 %
 Peak intensity 10.9 cd/Im
 LEDs/each optic 1
 Light colour White
 Required components:

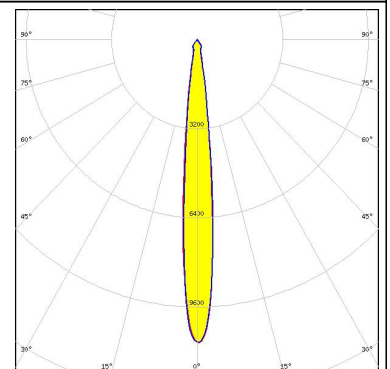
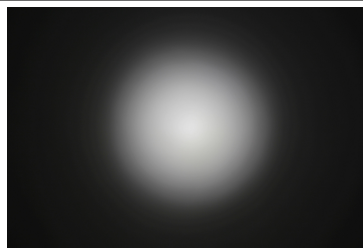

TRIDONIC

LED SLE G7 LES21 H
 FWHM 14.0°
 Efficiency 90 %
 Peak intensity 7.7 cd/Im
 LEDs/each optic 1
 Light colour White
 Required components:

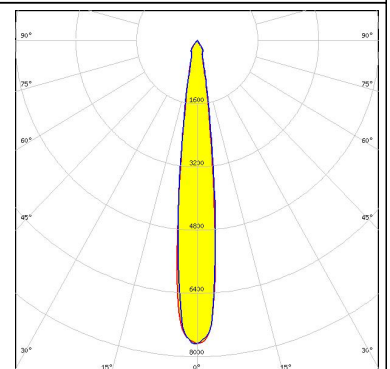

PHOTOMETRIC DATA (MEASURED):

XICATO

LED XOB 14.5 mm
FWHM 9.0°
Efficiency 92 %
Peak intensity 16.7 cd/lm
LEDs/each optic 1
Light colour White
Required components:
BJB: 47.319.2021

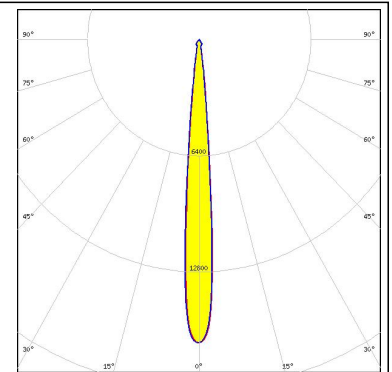

XICATO

LED XTM - 19mm LES
FWHM 12.0°
Efficiency 91 %
Peak intensity 11 cd/lm
LEDs/each optic 1
Light colour White
Required components:
C15743_XTM-ADAPTER-50-B

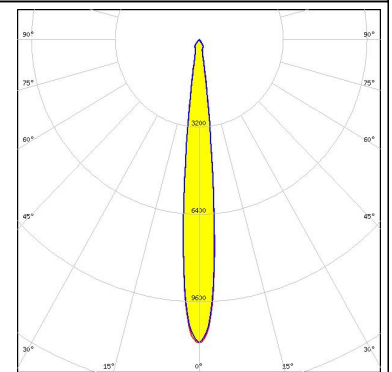
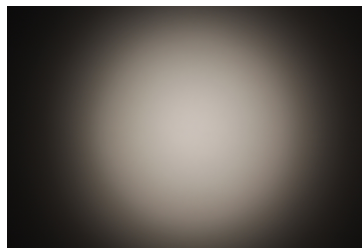

PHOTOMETRIC DATA (SIMULATED):

CITIZEN

LED CLL03x/CLU03x
 FWHM 9.3°
 Efficiency 94 %
 Peak intensity 19.2 cd/lm
 LEDs/each optic 1
 Light colour White
 Required components:
 BJB: 47.319.2021

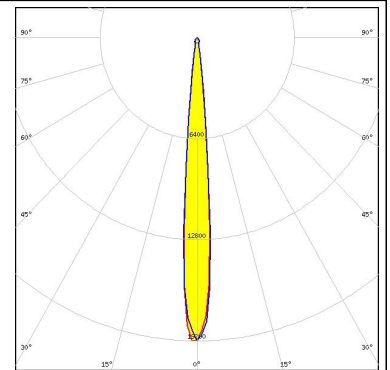

CITIZEN

LED CLL04x/CLU04x
 FWHM 14.0°
 Efficiency 93 %
 Peak intensity 8 cd/lm
 LEDs/each optic 1
 Light colour White
 Required components:
 BJB: 47.319.2030

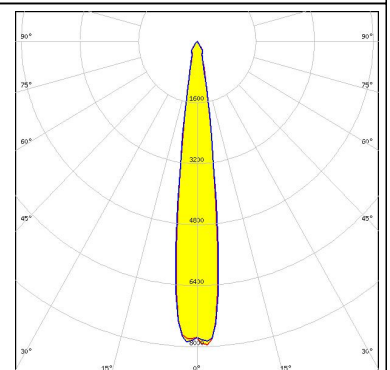

CITIZEN

LED CLU730/731
 FWHM 8.5°
 Efficiency 92 %
 Peak intensity 22.2 cd/lm
 LEDs/each optic 1
 Light colour White
 Required components:
 BJB: 47.319.2030

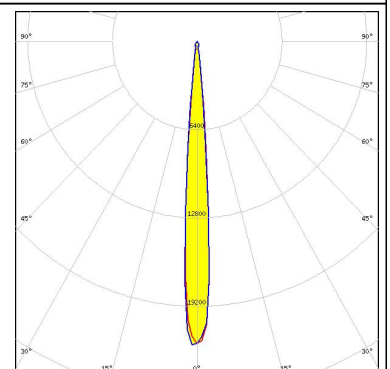

OSRAM

Opto Semiconductors

LED Soleriq S15
 FWHM 10.0°
 Efficiency 90 %
 Peak intensity 14.6 cd/lm
 LEDs/each optic 1
 Light colour White
 Required components:
 BJB: 47.319.2021

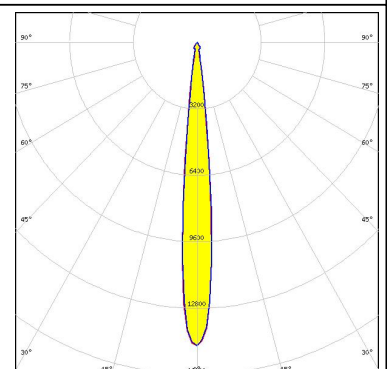

PHOTOMETRIC DATA (SIMULATED):

SAMSUNG

LED LC040D / LC060D / LC080D
FWHM 17.0°
Efficiency 87 %
Peak intensity 5.8 cd/Im
LEDs/each optic 1
Light colour White
Required components:
BJB: 47.319.2030

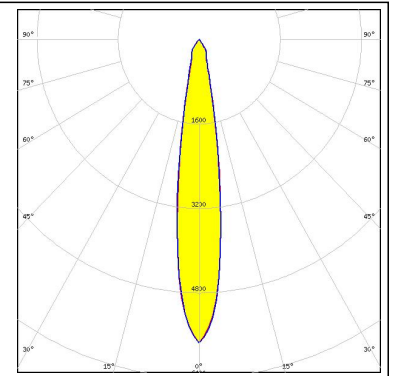

GENERAL INFORMATION:

NOTE: The typical beam angle will be changed by different color, chip size and chip position tolerance. The typical total beam angle is the full angle measured where the luminous intensity is half of the peak value.

Due to use of high power COB's with this product, special attention to proper thermal design is highly recommended. LEDiL has no liability for direct, indirect or consecutive damages arising from the LEDiL products being used outside of the recommended temperature range.

MATERIALS:

As part of our continuous research and improvement processes, and to ensure the best possible quality and availability of our products, LEDiL reserves the right to change material grades without notice.

PRODUCT DATA USER AGREEMENT AND DISCLAIMER:

The measured data in the provided downloadable LEDiL Product Datasheets and Mechanical 2D-Drawings is rounded and provided as reference for planning. LEDiL Oy's optical specifications have been verified by conducting performance testing of the products in accordance with the company's quality system. The reported data are averaged results of multiple measurements with typical variation. LEDiL Oy reserves the right to without prior notification make changes and improvements to its products.

LEDiL Oy assumes neither warranty, nor guarantee nor any other liability of any kind for the contents and correctness of the provided data. The provided data has been generated with highest diligence but the provided data may in reality not represent the complete possible variation range of all intrinsic parameters. Therefore, in certain cases a deviation from the provided data could occur.

LEDiL Oy reserves the right to undertake technical changes of its products without further notification which could lead to changes in the provided data. LEDiL Oy assumes no liability of any kind for the possible deviation from any provided data or any other damage resulting from the usage of the provided data.

The user agrees to this disclaimer and user agreement with the download or usage of the provided files.

LEDiL Oy

Joensuunkatu 13
FI-24240 SALO
Finland

LEDiL Inc.

228 West Page Street
Suite D
Sycamore IL 60178
USA

Local sales and technical support

[www.ledil.com/
where_to_buy](http://www.ledil.com/where_to_buy)

Shipping locations

Salo, Finland
Hong Kong, China

Distribution Partners

[www.ledil.com/
where_to_buy](http://www.ledil.com/where_to_buy)

Данный компонент на территории Российской Федерации

Вы можете приобрести в компании MosChip.

Для оперативного оформления запроса Вам необходимо перейти по данной ссылке:

<http://moschip.ru/get-element>

Вы можете разместить у нас заказ для любого Вашего проекта, будь то серийное производство или разработка единичного прибора.

В нашем ассортименте представлены ведущие мировые производители активных и пассивных электронных компонентов.

Нашей специализацией является поставка электронной компонентной базы двойного назначения, продукции таких производителей как XILINX, Intel (ex.ALTERA), Vicor, Microchip, Texas Instruments, Analog Devices, Mini-Circuits, Amphenol, Glenair.

Сотрудничество с глобальными дистрибьюторами электронных компонентов, предоставляет возможность заказывать и получать с международных складов практически любой перечень компонентов в оптимальные для Вас сроки.

На всех этапах разработки и производства наши партнеры могут получить квалифицированную поддержку опытных инженеров.

Система менеджмента качества компании отвечает требованиям в соответствии с ГОСТ Р ИСО 9001, ГОСТ РВ 0015-002 и ЭС РД 009

Офис по работе с юридическими лицами:

105318, г.Москва, ул.Щербаковская д.3, офис 1107, 1118, ДЦ «Щербаковский»

Телефон: +7 495 668-12-70 (многоканальный)

Факс: +7 495 668-12-70 (доб.304)

E-mail: info@moschip.ru

Skype отдела продаж:

moschip.ru

moschip.ru_4

moschip.ru_6

moschip.ru_9