

IEC Appliance Inlet C20 with Circuit Breaker TA45



Screw-on version from front or rear side  
 Rocker non-illuminated  
 white



Snap-in mounting from front side  
 Rocker illuminated  
 orange



See below:  
[Approvals and Compliances](#)

**Description**

- Panel mount :  
 Screw-on version from front or rear side, snap-in version from front side
- 2 Functions :  
 Appliance Inlet Protection class I , circuit breaker type TA45 2-pole
- Quick connect terminals 6.3 x 0.8 mm

**Characteristics**

- All single elements are already wired
- Unwired versions available on request
- Circuit Breaker non-illuminated or illuminated
- Suitable for use in equipment according to IEC/UL 60950

**Other versions on request**

- Unwired versions
- Variant with notch for V-Lock mating Cordsets

**References**

Alternative: version with line filter [EF12](#)

**Weblinks**

[pdf data sheet](#), [html datasheet](#), [General Product Information](#), [Distributor-Stock-Check](#), [Accessories](#), [Detailed request for product](#), [Landing Page](#)

Newly available variants corresponding to V-Lock mating cordset. The connector is equipped with a notch intended for use with the latching cordset. The cord latching system prevents against accidental removal of the cordset.

**Technical Data**

Ratings IEC	16A / 250VAC; 50Hz	appliance inlet/-outlet	C20 acc. to IEC 60320-1, UL 60320-1, CSA C22.2 no. 60320-1 (for cold conditions) pin-temperature 70 °C, 16A, Protection Class I
Ratings UL/CSA	20A / 250VAC; 60Hz	Circuit Breakers	Acc. IEC/EN 60934, UL 1077, CSA 22.2 no. 235 2-pole rocker switch, illuminated or non-illuminated. Optional with undervoltage- or remote trip release Short circuit capacity Icn: at In < 3A/240VAC : 10 x In at In ≥ 3A/240VAC : 300A
Dielectric Strength	> 1.5kVAC between L-N > 3kVAC between L/N-PE (1 min/50Hz)		
Allowable Operation Temperature	-10°C to 55°C		
IP-Protection	from front side IP40 acc. to IEC 60529		
Protection against electric shock	Suitable for appliances with protection class I acc. to IEC 61140		
Terminal	Quick connect terminals 6.3 x 0.8 mm		
Panel Thickness S	Screw: max 8 mm Mounting screw torque max 0.5Nm Snap-in: 1.5/2/2.5 mm		
Material: Housing	Thermoplastic, black, UL 94V-0		

**Approvals and Compliances**



Detailed information on product approvals, code requirements, usage instructions and detailed test conditions can be looked up in [Details about Approvals](#)

SCHURTER products are designed for use in industrial environments. They have approvals from independent testing bodies according to national and international standards. Products with specific characteristics and requirements such as required in the automotive sector according to IATF 16949, medical technology according to ISO 13485 or in the aerospace industry can be offered exclusively with customer-specific, individual agreements by SCHURTER.

## Approvals



The approval mark is used by the testing authorities to certify compliance with the safety requirements placed on electronic products.

Approval Reference Type: EF11

Approval Logo	Certificates	Certification Body	Description
	<a href="#">VDE Approvals</a>	VDE	Certificate Number: 40001029
	<a href="#">UL Approvals</a>	UL	UL File Number: E96454

## Product standards

Product standards that are referenced

Organization	Design	Standard	Description
	Designed according to	IEC 60320-1	Appliance couplers for household and similar general purposes
	Designed according to	UL 60320-1	Standard for Attachment Plugs and Receptacles
	Designed according to	CSA C22.2 no. 60320-1	General Use Receptacles, Attachment Plugs, and Similar Wiring Devices





## Application standards

Application standards where the product can be used

Organization	Design	Standard	Description
	Designed for applications acc.	IEC/UL 60950	IEC 60950-1 includes the basic requirements for the safety of information technology equipment.

## Compliances

The product complies with following Guide Lines

Identification	Details	Initiator	Description
	<a href="#">CE declaration of conformity</a>	SCHURTER AG	The CE marking declares that the product complies with the applicable requirements laid down in the harmonisation of Community legislation on its affixing in accordance with EU Regulation 765/2008.
	<a href="#">RoHS</a>	SCHURTER AG	Directive RoHS 2011/65/EU, Amendment (EU) 2015/863
	<a href="#">China RoHS</a>	SCHURTER AG	The law SJ / T 11363-2006 (China RoHS) has been in force since 1 March 2007. It is similar to the EU directive RoHS.
	<a href="#">REACH</a>	SCHURTER AG	On 1 June 2007, Regulation (EC) No 1907/2006 on the Registration, Evaluation, Authorization and Restriction of Chemicals 1 (abbreviated as "REACH") entered into force.
	<a href="#">Landing Page V-Lock</a>	SCHURTER AG	V-Lock system are based on a matching plug-dose combination. The connector is equipped with a notch intended for use with the latching cordset. The cord latching system prevents against accidental removal of the cordset.

**Dimensions [mm]**  
 Screw-on mounting

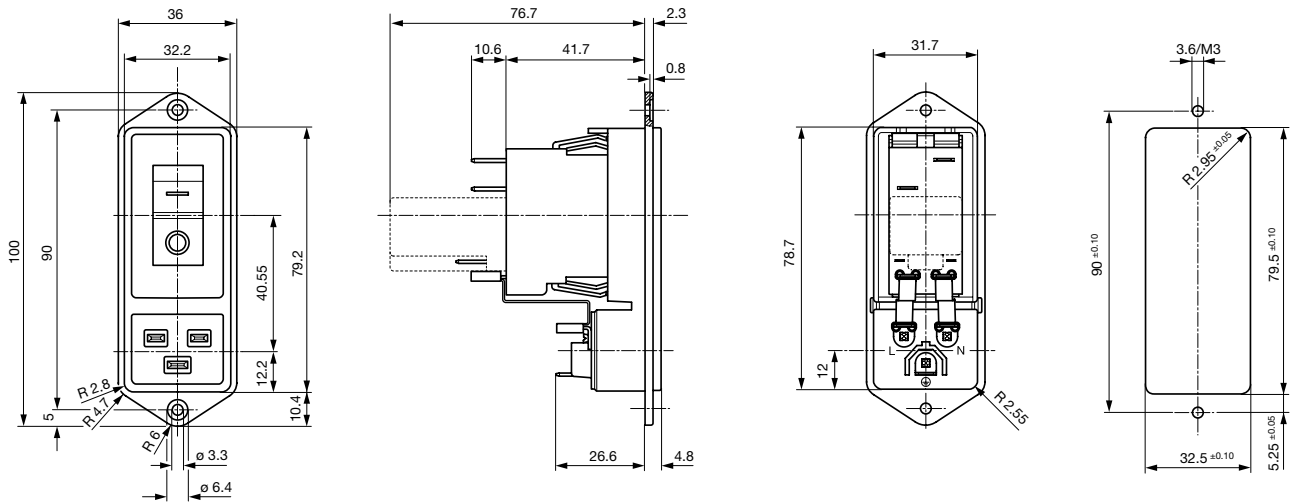

\*\* --- Version TA45 with undervoltage release

Snap-in mounting

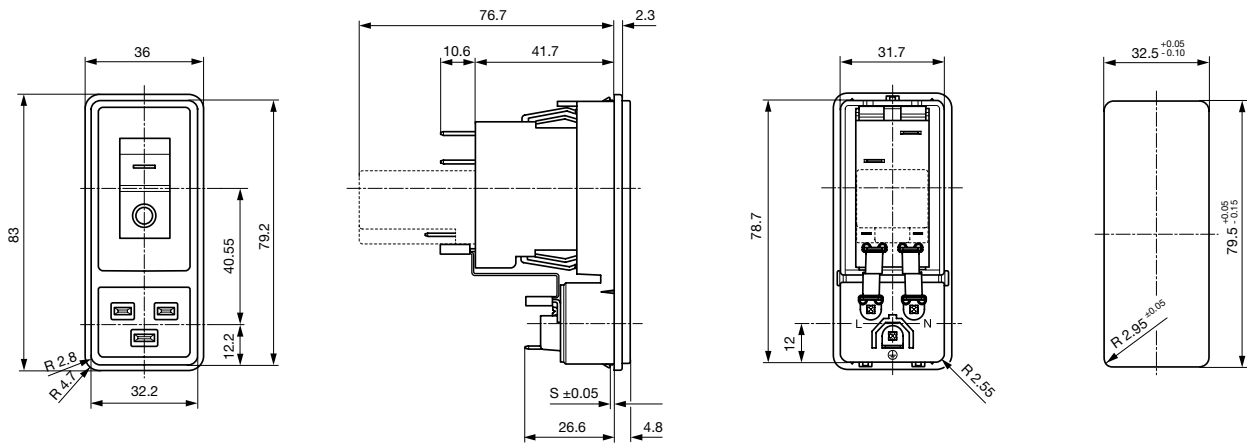

\*\* --- Version TA45 with undervoltage release

Diagrams

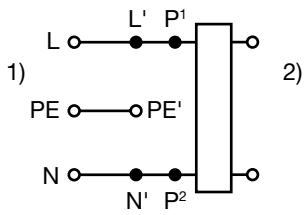

1) Line  
 2) Load

Effect of ambient temperature

The units are calibrated for an ambient temperature of +23°C. To determine the rated current for a lower or higher ambient temperature, use a correction factor (typical value) from the table below:

Ambient Temperature [°C]	Correction factor
-10	0.89
-5	0.91
0	0.92
+23	1.00
+30	1.03
+40	1.08
+55	1.16

Example: Rated current = 5 A, Environmental temperature = 40 °C, --> Correction factor = 1.08, Resulting current = 5.5 A --> Fount to next higher rated current: 6 A

Time-Current-Curves

Tripping Characteristics  $I_n < 3 A$

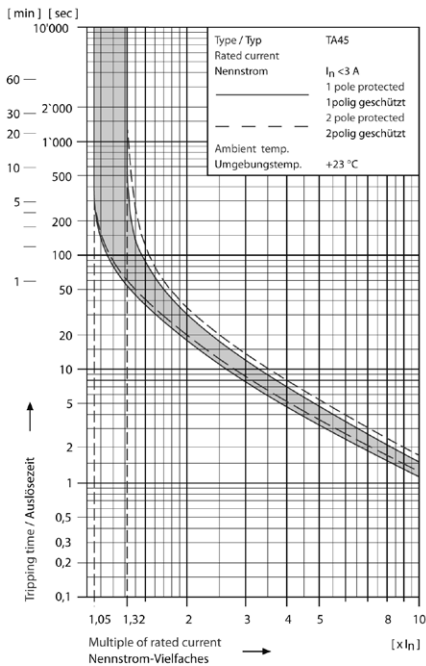

Tripping Characteristics  $I_n \geq 3 \dots < 18 A$

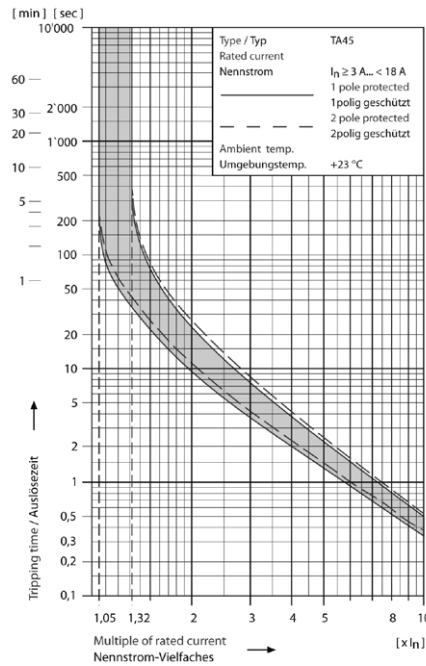

Tripping Characteristics  $I_n \geq 18$  A

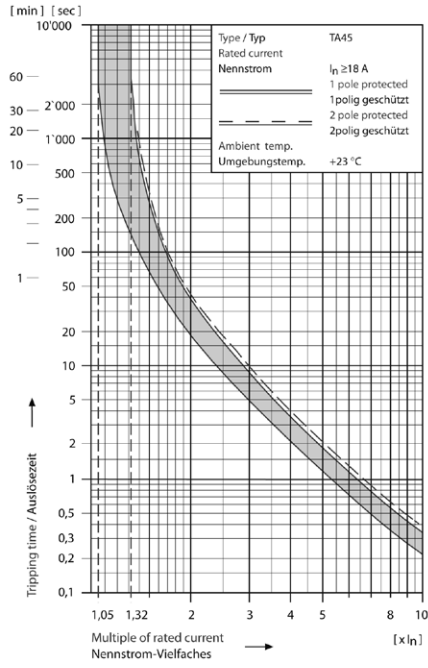

## Configuration code TA45

Type	Configuration code TA45												
EF11	A	B	T	W	F	1	5	0	C	0	000	111	000

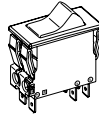

- Circuit Breaker of Equipment
- 2-pole, rocker actuated
- Quick connect terminal
- Other types on request

### Without release: code C0

#### Undervoltage release

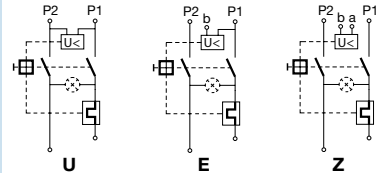

•	•	•
•	•	•
•	•	•

#### Remote trip release

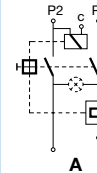

•
•
•

Code	Rated voltage $U_n$
2	240 V AC
3	230 V AC
4	120 V AC

### Rated current circuit breaker of equipment

$I_n$	Code	$I_n$	Code	$I_n$	Code	$I_n$	Code
10,0	100	13,0	130	16,0	160	19,0	190
11,0	110	14,0	140	17,0	170	20,0	200
12,0	120	15,0	150	18,0	180		

Other rated currents on request

### Rocker legend

Surface	Illustration	Colour of print
F embossed	— ○	
H printed	ON OFF	white
K printed	ON OFF	black
L printed	— ○	white
M printed	— ○	black
P printed	I ○	white
R printed	I ○	black

Position of the rocker legend e.g F

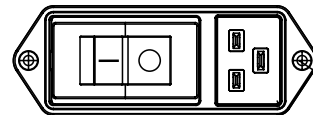

### Colours

Switch front	Rocker
W black	white
B black	black
6 black	—
	orange transp.

### Diagram

Thermal overload protection

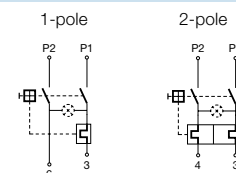

Without illumination

**ABT**      **ABD**

With illumination      220...240 V  
 110...120 V

**A12**      **A32**  
**A14**      **A34**

Configuration code (Order example)

Type	Configuration code TA45			
EF11	A B T W F 1 5 0 C 0	0 0 0	1 1 1	0 0 0

**Optional Variants**

- 0 standard
- 9 V-Lock notch

**Colour**

- 0 black

**Mounting**

- 0 Screw mounting
- 2 Snap-in mounting s = 1.5
- 3 Snap-in mounting s = 2.0
- 4 Snap-in mounting s = 2.5

**Terminal PE**

- 1 Quick-connect terminals 6.3x0.8mm

**Terminal N**

- 1 Quick-connect terminals 6.3x0.8mm, without connection to TA45
- 3 connection to TA45 non insulated

**Terminal L**

- 1 Quick-connect terminals 6.3x0.8mm, without connection to TA45
- 3 connection to TA45 non insulated

Packaging unit 16 Pcs

## Accessories

### Description

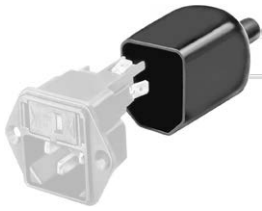

Assorted Covers  
Rear Cover

0859.0109



Cord retaining kits  
Cord retaining strain relief

Flat head, H

4700.0008

## Mating Outlets/Connectors

### Category / Description



#### Connector Overview complete

4795, Mounting: Power Cord, Cable Connector: IEC C19

4795

4790, Mounting: Power Cord, Screw Connector: IEC C19

4790

0104U, Mounting: Power Supply Cord, Screw clamps Connector: IEC C19

0104U

Connector further types to EF11



#### Power Supply Cord Overview complete

Cord Sets 10 A, North America, 3.0 m, Connector IEC C13, SJT 3x18 AWG, Transparent

4300.0920

Cord Sets 16 A, Europlug, 2.5 m, Connector IEC C19, H05VV-F3G1.5, black

6004.0395

Cord Sets 16 A, Interconnection, 1.0 m, Connector IEC C19, H05VV-F3G1.5, black

6020.0392

Cord Sets 16 A, Interconnection, 2.0 m, Connector IEC C19, H05VV-F3G1.5, black

6020.0394

Cord Sets 16 A, North America, 2.5 m, Connector IEC C19, SJT 3x14 AWG, black

6009.5195

Power Supply Cord further types to EF11

## Mating Outlets/Connectors shuttered



#### Power Cord Overview complete

VAC19KS, Overview, V-Lock cord retaining, diverse Connector IEC C19, diverse, black

VAC19KS

Power Cord further types to EF11



## Данный компонент на территории Российской Федерации

### Вы можете приобрести в компании MosChip.

Для оперативного оформления запроса Вам необходимо перейти по данной ссылке:

<http://moschip.ru/get-element>

Вы можете разместить у нас заказ для любого Вашего проекта, будь то серийное производство или разработка единичного прибора.

В нашем ассортименте представлены ведущие мировые производители активных и пассивных электронных компонентов.

Нашей специализацией является поставка электронной компонентной базы двойного назначения, продукции таких производителей как XILINX, Intel (ex.ALTERA), Vicor, Microchip, Texas Instruments, Analog Devices, Mini-Circuits, Amphenol, Glenair.

Сотрудничество с глобальными дистрибьюторами электронных компонентов, предоставляет возможность заказывать и получать с международных складов практически любой перечень компонентов в оптимальные для Вас сроки.

На всех этапах разработки и производства наши партнеры могут получить квалифицированную поддержку опытных инженеров.

Система менеджмента качества компании отвечает требованиям в соответствии с ГОСТ Р ИСО 9001, ГОСТ РВ 0015-002 и ЭС РД 009

### Офис по работе с юридическими лицами:

105318, г.Москва, ул.Щербаковская д.3, офис 1107, 1118, ДЦ «Щербаковский»

Телефон: +7 495 668-12-70 (многоканальный)

Факс: +7 495 668-12-70 (доб.304)

E-mail: [info@moschip.ru](mailto:info@moschip.ru)

Skype отдела продаж:

moschip.ru

moschip.ru\_4

moschip.ru\_6

moschip.ru\_9