

COOPER

Bussmann®

Productivity Through Protection™

Circuit Protection Solutions

Low Voltage Fuse Links Catalogue



COOPER Bussmann

Table of Contents

Domestic Applications to BS1361 & BS1312	
Consumer Unit Fuse Link	4
Plug Top Fuse Links	4
Industrial & Motor Applications to BS88	
Offset Bolted Tags	5 - 7
Centre Bolted Tags	8 - 9
Offset Blade Tags	10
Merchandising Stand	11
Industrial Applications to BS88 - 500Vdc	
Special DC Range Offset/Centre Bolted Tag	12
Industrial Applications to BS88 - 660/690V	
Offset Bolted Tags	13
Centre Bolted Tags	14
Special Tag Arrangements	15
Street Lighting Applications to BS88	
Offset Bolted Tags	16
Utility Applications to BS88	
House-Service Cut-Out Fuse Links	17
J Type Fuse Links to BS88: Part 5 Cylindrical	17
J Type Fuse Links to BS88: Part 5 Slotted/Non Slotted	18
Joint NATO Reference System	
Cylindrical/Offset Bolted Tag	19
BS88 Fuseholders	
Camaster HRC Fuseholder	20
Safeloc Fuseholder	21
Cylindrical Domestic Fuses	22
Domestic Fuses	23
Cylindrical Industrial Fuses	
Class gG	24
Class aM	25
CHD	26
CHM	27
CH	28
NH Fuses - Dual Indicator	
Class gG - Low Power Loss	29 - 30
Class gG	31
Class aM	32 - 33
Class gG - aM	34
NH Fuses - Dimensions	35
NH Fuseholders for Knife Fuses	36
Dimensions for Knife fuse and Fuseholders (NH)	37 - 38
NH Fuse Rails and Disconnectors	39 - 41
DO Fuses	42
DO Fuseholders	43
D Fuses	44
D Fuseholders	45
Other Low Voltage Fuse Ranges	46
Medium Voltage Fuses and Isolators	47
Ultra Fast Fuses and Holders	48 - 49



Domestic Applications to BS1361 & BS1312

**Consumer Unit Fuse Link
240V / 5 - 45 A**



Specifications

Description: Cylindrical Fuse Links for domestic application according to BS1361

Ratings:

Volts: - 240V
Amps: - 5 - 45A
IR - 16.5kA

Applications: Protection of domestic distribution systems.

Agency Information: Approved to BS1361

Catalogue Numbers

Rating (A)	Catalogue Number	Colour Code	Unit Packing
5	C55	White	10
15	C1515	Blue	
20	C1520	Yellow	
30	C3030	Red	
45	C4545	Green	

BK (Part Number), Unit packing = 100

Dimensions

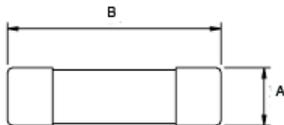

Catalogue Number	A	B
C55	5.35	23
C1515	10.2	26
C1520	10.32	26
C3030	12.7	29
C4545	16.67	35

**Plug Top Fuse Links
240V / 1 - 13A**



Specifications

Description: Cylindrical Fuse links for domestic applications according to BS1362, to be fitted into domestic BS1363 plug top to conform with the requirements of the Plug and Socket Safety Regulations 1995

Ratings:

Volts: - 240V
Amps: - 1 - 13A
IR - 6kA

Applications: protection of the cables connected to domestic equipment against overloads or small overcurrents.

Agency Information: BSI Kite Mark, ASTA accreditation (except 1A Fuse), BS1362

RoHS Compliant

Catalogue Numbers

Rating (A)	Catalogue Number	Colour Code	Unit Packing
1	C180-1A	Black	10
2	C180-2A	Black	
3	C180-3A	Red	
5	C180-5A	Black	
7	C180-7A	Black	
10	C180-10A	Black	
13	C180-13A	Black	

BK-(Part Number), Unit packing= 100

Dimensions

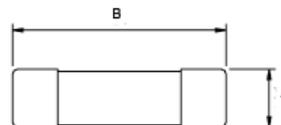

Catalogue Number	A	B
C180-RatingA	6.45	25.4

Industrial & Motor Applications to BS88

Offset Bolted Tags
240 - 550V ac / 2 - 32A

Specifications

Description: Fuse Links for general industrial applications with Q1 fusing factor - general purpose (gG) and motor protection (gM) characteristics

Applications: General Industrial & Motors applications

Ratings:

- Volts: - 415 - 550V ac
- Amps: - 2 - 32A
- IR - 80kA @ 415/550V ac

Agency information: Meets BS88: Part 1 & 2 (1988), IEC 269: Parts 1 (1986)

RoHS Compliant

NITD
550V ac (gG) / 2 - 32A
415V ac (gM)



Catalogue Numbers

Rating (A)	Catalogue Number	Class	BS Ref	Fixing Centres mm	Unit Packing
2	NITD2	gG	A1	44	20
4	NITD4				
6	NITD6				
10	NITD10				
16	NITD16				
20	NITD20				
25	NITD25				
32	NITD32				
20M25	NITD20M25				
20M32	NITD20M32				
32M40	NITD32M40	gM			
32M50	NITD32M50				
32M63	NITD32M63				

Fuseholders: CAMASTER CM32FC, see page 20

Dimensions

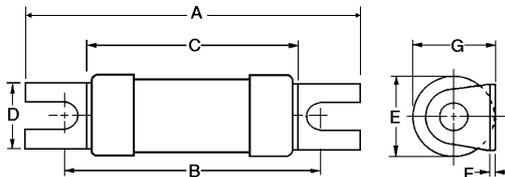

Part No	Dimensions (mm)						
	A	B	C	D	E	F	G
NITD	55.0	44	34.6	11.2	13.8	0.8	14.0
NITD32M			35.6		17.5	1.2	18.5

Data Sheet: 4106

AAO
550V ac / 2 - 32A



Catalogue Numbers

Rating (A)	Catalogue Number	Class	BS Ref	Fixing Centres mm	Unit Packing
2	AAO2	gG	A2	73	20
4	AAO4				
6	AAO6				
10	AAO10				
16	AAO16				
20	AAO20				
25	AAO25				
32	AAO32				
32M40	AAO32M40				
32M50	AAO32M50				
32M63	AAO32M63				

Fuseholders: CAMASTER CM32F, see page 20

Dimensions

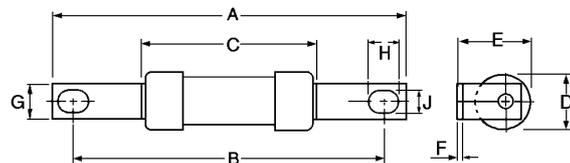

Part No	Dimensions (mm)								
	A	B	C	D	E	F	G	H	J
AAO	85	73	35.5	13.7	14	1.2	8.7	8.0	5.5
AAO32M			54.5	21	22.3				

Data Sheet: 4109

Industrial & Motor Applications to BS88

Offset Bolted Tags (Cont.../...)
240-550V / 32 - 100A

Specifications

Description: Fuse Links for general industrial applications with Q1 fusing factor - general purpose (gG) and motor protection (gM) characteristics

Applications: General Industrial & Motors applications

Ratings:

Volts: - 415 - 550V ac
 Amps: - 32 - 100A
 IR - 80kA @ 415 / 550V ac

Agency information: Meets BS88: Part 1 & 2 (1988), IEC 269: Parts 1 (1986) and CSA C22.2 No 106-M 1985

RoHS Compliant

BAO
550V ac / 35-63A



Catalogue Numbers

Rating (A)	Catalogue Number	Class	BS Ref	Fixing Centres mm	Unit Packing
35	BAO35	gG	A3	73	20
40	BAO40				
50	BAO50				
63	BAO63				
63M80	BAO63M80	gM			
63M100	BAO63M100				

Fuseholder: CAMASTER CM63F, see page 20

Dimensions

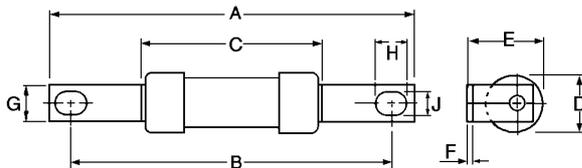

Part No	Dimensions (mm)								
	A	B	C	D	E	F	G	H	J
BAO	87	73	54.5	21	22.5	1.2	12.7	8.0	5.5
BAO63M									

Data Sheet: 4112

CEO
550V ac / 32-100A
415V ac (gM)



Catalogue Numbers

Rating (A)	Catalogue Number	Class	BS Ref	Fixing Centres mm	Unit Packing
32	CEO32	gG	A4	94	10
40	CEO40				
50	CEO50				
63	CEO63				
80	CEO80				
100	CEO100				
100M125	CEO100M125	gM			
100M160	CEO100M160				
100M200	CEO100M200				

Dimensions

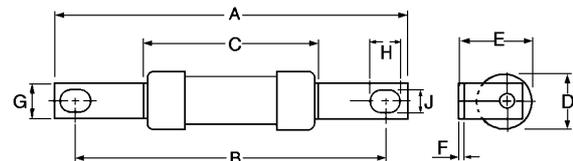

Part No	Dimensions (mm)								
	A	B	C	D	E	F	G	H	J
CEO	110	94	58.5	21.0	24.5	3.2	14.3	11.0	8.7
CEO100M125 & 160				25.8	26.8				
CEO100M200			47.0	31	29.5	19.0	10.0	9.0	

Data Sheet: 4115

Industrial & Motor Applications to BS88

Offset Bolted Tags (Cont.../...)
240 - 550V ac / 80 - 200A

Specifications

Description: Fuse Links for general industrial applications with Q1 fusing factor - general purpose (gG) and motor protection (gM) characteristics

Applications: General Industrial & Motors applications

Ratings:

Volts: - 415 - 550V ac
 Amps: - 80 - 200A
 IR - 80kA @ 415 / 550V ac

Agency information: Meets BS88: Part 1 & 2 (1988), IEC 269: Parts 1 (1986)

RoHS Compliant

OSD
550V ac (gG) / 80 - 100A
415V ac (gM)



Catalogue Numbers

Rating (A)	Catalogue Number	Class	BS Ref	Fixing Centres mm	Unit Packing
80	OSD80	gG	N/A	73	20
100	OSD100				
100M125	OSD100M125	gM	N/A	73	20
100M160	OSD100M160				

Fuseholders: CAMASTER CM100F, see page 20

Dimensions

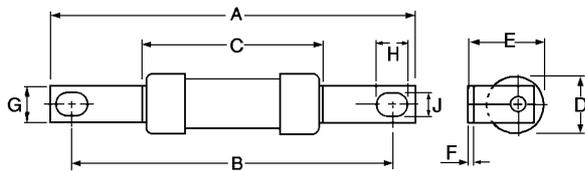

Part No	Dimensions (mm)								
	A	B	C	D	E	F	G	H	J
OSD	95.0	73	54.5	21.0	22.5	1.2	12.7	8.0	5.5
OSD100M				26.0	25.7				

DEO
415V ac / 125 - 200A (gG) (gM)



Catalogue Numbers

Rating (A)	Catalogue Number	Class	BS Ref	Fixing Centres mm	Unit Packing
125	DEO125	gG	N/A	94	5
160	DEO160				
200	DEO200				
200M250	DEO200M250	gM	N/A	94	5
200M315	DEO200M315				

Dimensions

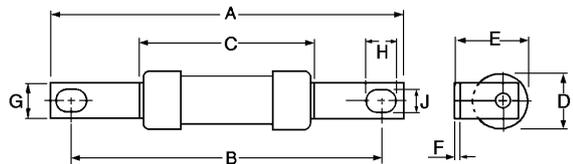

Part No	Dimensions (mm)								
	A	B	C	D	E	F	G	H	J
DEO	110	94	47.0	31.0	29.5	3.2	19.0	10.0	9.0
DEO200M									

Industrial & Motor Applications to BS88

Centre Bolted Tags
415 - 550V ac / 2 - 1250A
250V dc

Specifications

Description: Fuse Links for general industrial applications with Q1 fusing factor - general purpose (gG) and motor protection (gM) characteristics

Applications: General Industrial & Motors applications

Ratings:

- Volts: - 415 - 550V ac / 250V dc
- Amps: - 2 - 1250A
- IR - 40kA @ 250V dc
- 80kA @ 415 / 550V ac

Agency information: Meets BS88: Part 1 & 2 (1988), IEC 269: Parts 1 (1986)

RoHS Compliant

AC / BC
550V ac / 2 - 63A
250 V dc (except gM)



Catalogue Numbers

Type	Rating (A)	Catalogue Number	Class	Fixing Centres mm	Unit Packing
AC	2	AC2	gG	97.5	20
	4	AC4			
	6	AC6			
	10	AC10			
	16	AC16			
	20	AC20			
	25	AC25			
BC	32	AC32	gG	97.5	20
	40	BC40			
	50	BC50			
	63	BC63			
	63M80	BC63M80			
	63M100	BC63M100	gM		

Dimensions

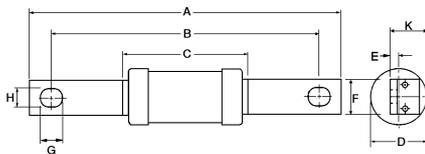

AD / BD / CD / DD / ED
550V ac / 2 - 400A
415V ac (Types gM, DD, ED)
250 V dc (Types AD, BD)



Catalogue Numbers

Type	Rating (A)	Catalogue Number	Class	Ref BS	Fixing Centres mm	Unit Packing
AD	2	AD2	gG	N/A	111	20
	4	AD4				
	6	AD6				
	10	AD10				
	16	AD16				
	20	AD20				
	25	AD25				
BD	32	AD32	gG	N/A	111	20
	40	BD40				
	50	BD50				
CD	63	BD63	gG	B1	111	10
	80	CD80				
	100	CD100				
	100M125	CD100M125				
	100M160	CD100M160				
DD	100M200	CD100M200	gM	B2	111	5
	125	DD125				
	160	DD160				
	200	DD200				
	200M250	DD200M250				
ED	200M315	DD200M315	gM	B3/B4	111	1
	250	ED250				
	315	ED315				
	355	ED355				
	400	ED400				
315M400	ED315M400	gM				
400M500	ED400M500*					

*-550V ac

Part No	Dimensions								
	A	B	C	D	E	F	G	H	K
AC	113.5	97.5	55.5	21.0	1.6	12.7	13.5	7.0	11.2
AD	128.5	111	55.0	21.0	1.4	14.2	11.8	8.7	11.2
BC	113.5	97.5	55.0	21.0	1.6	7.0	13.5	12.7	11.2
BC63M									
BD	128.5	111	55.0	21.0	1.4	14.2	11.8	8.7	11.2
CD	126	111	58.5	21.0	3.2	14.3	11.1	8.7	19.5
CD100M125 & CD100M160				26.0					22.0
CD100M200				31.0					2.5
DD	136	111	47.0	31.0	3.2	19.0	12.5	9.0	22.5
DD200M									
ED250	136	111	47.0	31.0	4.7	19.0	12.5	9.0	22.5
ED315			50.0	38.0		31.0			
ED315M400.0			75.0	59.0		31.0			
ED400M500									

Data Sheets: AC: 4110 / BC: 4113 / AD: 4111 / BD: 4114 / CD: 4116 / DD: 4118 / ED: 4119

Industrial & Motor Applications to BS88

Centre Bolted Tags (Cont.../...)

415 - 550Vac / 125 - 1250A
250 - 400Vdc

Specifications

Description: Fuse Links for general industrial applications with Q1 fusing factor - general purpose (gG) and motor protection (gM) characteristics

Applications: General Industrial & Motors applications

Ratings:

- Volts: - 415 - 550V ac / 250V dc
- Amps: - 2 - 1250A
- IR - 40kA @ 250V dc GF, GG except 1000 & 1250A
- 40kA @ 400V dc FG, FF
- 80kA @ 415/550V ac

Agency information: Meets BS88: Part 1 & 2 (1988), IEC 269: Parts 1 (1986)

RoHS Compliant

EFS / EF / FF / GF
415V ac / 125 - 800A
550V ac (Types EF - gM, FF, FG, GF)
250V dc (Type GF)



Catalogue Numbers

Type	Rating (A)	Catalogue Number	Class	Ref BS	Fixing Centres mm	Unit Packing	Interrupting Rating
EFS	125	EFS125	gG	N/A	133	1	80kA @ 415 Vac
	160	EFS160					
	200	EFS200					
	250	EFS250					
	315	EFS315					
EF	355	EF355	gG	C1	133/184	1	80kA @ 415 Vac
	400	EF400					
	400M500	EF400M500	gM				
FF	450	FF400	gG	C2	133/184	1	80kA @ 415 Vac 40kA @ 400Vdc
	500	FF500					
	560	FF560					
	630	FF630					
GF	710	GF710	gG	C3	133/184	1	80kA @ 550Vac 40kA @ 250Vdc
	800	GF800					
	1000	GF1000					
	1250	GF1250					

Dimensions

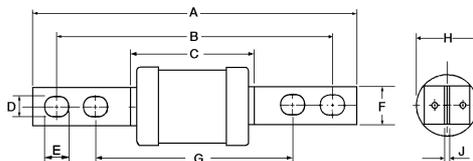

Part No	Dimensions (mm)								
	A	B	C	D	E	F	G	H	J
EFS315	209	184	50.0	10.5	12.5	25.4	133	38.0	4.7
EF355 & 400									
EF400M500	210	184	75.0		15.5			59.0	
FF	210	184	77.5	10.5	15.5	25.4	133	74.0	6.4
FG	262	231	77.5	10.5	15.5	38.0	167	74	6.4
GF	210	184	80.5	10.5	15.5	25.4	133	83.0	9.5

Data Sheets: EFS: 4121 / EF: 4120 / FF: 4102 / GF: 4103

FG / GG / GH
550V ac / 450 - 1250A
250V dc (Type GG 710-800A only)
400V dc (Type FG)



Catalogue Numbers

Type	Rating (A)	Catalogue Number	Class	Fixing Centres mm	Unit Packing	Interrupting Rating
FG	450	FG450	gG	167/231	1	80kA @ 550Vac 40kA @ 400Vdc
	500	FG500				
	560	FG560				
	630	FG630				
GG	710	GG710	gG	165/231	1	80kA @ 550Vdc 40kA @ 250Vdc
	800	GG800		165/228.5		
	1000	GG1000				
	1250	GG1250				
GH	710	GH710	gG	149	1	80kA @ 550Vac
	800	GH800				
	1000	GH1000				
	1250	GH1250				

Dimensions

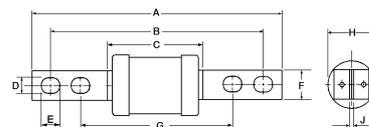

Part No	Dimensions (mm)								
	A	B	C	D	E	F	G	H	J
FG	262	231	77.5	10.5	15.5	38.0	167	74	6.4
GF	210	184	80.5	10.5	15.5	25.4	133	83.0	9.5
GG710 & 800	262	231	77.5	10.5	15.5	38.0	165	83.0	6.4
GG1000 & 1250		228.5	84.0					100	12.7

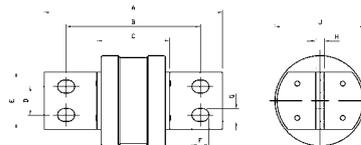

Part No	Dimensions (mm)								
	A	B	C	D	E	F	G	H	J
GH710 & 800	198	149	81.0	32.0	63.5	19.0	14.0	9.5	83.0
GH1000 & 1250									100

Data Sheets: FG: 4122 / GG: 4104 / GH: 4108

Industrial & Motor Applications to BS88

Offset Blade Tags 240 - 550V / 2 - 63A

Specifications

Description: Fuse Links for general industrial applications with Q1 fusing factor - general purpose (gG) and motor protection (gM) characteristics.

Ratings:

- Volts: - 240V ac (SSD)
 - 415V ac (NSD gM) / ESD gG (40 - 63A)
 - 550V ac (NSD gG) / ESD gG (2 - 32A)
- Amps: - 2 - 63A
 IR - 33kA @ 240V ac
 - 80kA @ 500V ac

Applications: General Industrial and Motors applications

Agency Information: Meets BS88: Part 6, 1988 and IEC 269: Parts 1, 1986

RoHS Compliant

Dimensions

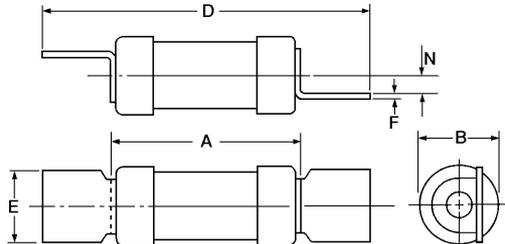

Part No	Dimensions (mm)					
	A	B	D	E	F	N
SSD	23.0	12.0	47.0	13.0	0.8	3.2
NSD & NSD20M	34.5	13.8	58.5	12.7	0.8	3.5
NSD20M36 & NSD32M		17.5				
ESD - 32A	35.5	13.8	68.0	15.0	1.2	3.5
ESD40 - 63A		17.5				
ESD63M		21.0				

Catalogue Numbers

Rating (A)	Catalogue Number	Class	BS Reference	Fuseholder	Unit Packing
2	SSD2	gG	E1	N/A	20
4	SSD4				
6	SSD6				
10	SSD10				
16	SSD16				
20	SSD20				
32	SSD32				

Rating (A)	Catalogue Number	Class	BS Reference	Fuseholder	Unit Packing
2	NSD2	gR	F1	SAFELOC 32NNSF	20
4	NSD4				
6	NSD6				
10	NSD10				
16	NSD16				
20	NSD20				
32	NSD32				
20M25	NSD20M25	gM	F1	SAFELOC 32NNSF	20
20M32	NSD20M32				
20M36	NSD20M36				
32M36	NSD32M36				
32M40	NSD32M40				
32M50	NSD32M50				
32M63	NSD32M63				

Rating (A)	Catalogue Number	Class	BS Reference	Fuse Holder	Unit Packing
2	ESD2	gG	F2	SAFELOC 63ENSF	20
4	ESD4				
6	ESD6				
10	ESD10				
16	ESD16				
20	ESD20				
32	ESD32				
40	ESD40				
50	ESD50				
63	ESD63				
63M80	ESD63M80	gM	F2	SAFELOC 63ENSF	20
63M100	ESD63M100				

Data Sheet SSD: 4105
 Data Sheet NSD: 4100

Point of Sale Stand

Merchandising Stand

Specifications

Description: Merchandising stand with BS88 fuses packed in packs of 3's or 10's

Stand dimensions: 1.88 Metre tall x 0.91 Metre wide x 0.51 Metre deep* (including hooks)



Please note this stand is for the UK market only

Catalogue Numbers

Part Number	Part Description	Pack Qty (Nb of fuses per pack)	Outer box Qty (MOQ)
M-AAO10	10A 550V BS88 Fuse	3	30
M-AAO16	16A 550V BS88 Fuse	3	30
M-AAO20	20A 550V BS88 Fuse	3	30
M-AAO25	25A 550V BS88 Fuse	3	30
M-AAO32	32A 550V BS88 Fuse	3	30
M-BAO40	40A 550V BS88 Fuse	3	30
M-BAO50	50A 550V BS88 Fuse	3	30
M-BAO63	63A 550V BS88 Fuse	3	30
M-CD100	100A 550V BS88 Fuse	3	30
M-CEO80	80A 550V BS88 Fuse	3	30
M-CEO100	100A 550V BS88 Fuse	3	30
M-NITD2	2A 550V BS88 Fuse	3	30
M-NITD10	10A 550V BS88 Fuse	3	30
M-NITD16	16A 550V BS88 Fuse	3	30
M-NITD20	20A 550V BS88 Fuse	3	30
M-NITD32	32A 550V BS88 Fuse	3	30
M-C180-3A	3A BS1362 Fuse	10	100
M-C180-5A	5A BS1362 Fuse	10	100
M-C180-13A	13A BS1362 Fuse	10	100
M-NSD4	4A 550V BS88 Fuse	3	30
M-NSD6	6A 550V BS88 Fuse	3	30
M-NSD10	10A 550V BS88 Fuse	3	30
M-NSD16	16A 550V BS88 Fuse	3	30
M-NSD20	20A 550V BS88 Fuse	3	30
M-NSD32	32A 550V BS88 Fuse	3	30
M-NITD6	6A 550V BS88 Fuse	3	30
M-STD6	6A 240V BS88 Fuse	3	30
M-STD10	10A 240V BS88 Fuse	3	30
M-32NNSF	32A Safeloc Fuseholder	1	5
M-63ENSF	63A Safeloc Fuseholder	1	5
M-CM20F	20A Camaster Fuseholder	1	5
M-CM32FC	32A Camaster Fuseholder Compact	1	5
M-CM32F	32A Camaster Fuseholder	1	5
M-CM63F	63A Camaster Fuseholder	1	5
M-CM100F	100A Camaster Fuseholder	1	5

Industrial Applications to BS88 - 500Vdc

Special DC Range Offset/Centre Bolted Tag 500Vdc / 10 - 63A

Specifications

Description: Fuse links for industrial DC applications available in offset and centre bolted tags

Ratings:

Volts: - 500V dc
Amps: - 10 - 63A
IR - 40kA @ 500V dc

Applications: Protection of DC electrical circuits

Agency information: ASTA approved to BS88 part 2

RoHS Compliant

Dimensions

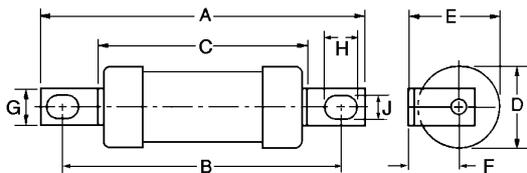

Part No	Dimensions (mm)							
	A	B	C	D	F	G	H	J
HS07	86.0	73	54.0	22.0	0.8	9.2	8.0	5.0
KS07	91.0			27.0	1.2	13.0	10.5	

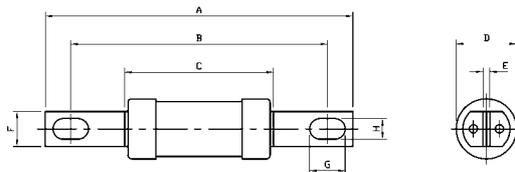

Part No	Dimensions (mm)							
	A	B	C	D	E	F	G	H
KS08	113.0	98	56.0	27.0	2.5	13.0	13.0	5.0
KS09	138.0	111				14.5	15.0	8.0

Catalogue Numbers

Rating (A)	Offset Bolted	Center fixings Centre Bolted		Unit Packing
	73mm	98mm	111mm	
10	10HS07	-	10KS09	20
16	16HS07	-	16KS09	
20	20HS07	-	20KS09	
25	25HS07	-	25KS09	
32	32HS07	-	32KS09	
40	40KS07	40KS08	40KS09	
50	50KS07	50KS08	50KS09	
63	63KS07	63KS08	63KS09	



Industrial Applications to BS88 - 660/690V

Offset Bolted Tags
660-690V / 2 - 200A

Specifications

Description: Fuse links for industrial applications at 660/690V that meets dimensional and performance requirements of BS88 and IEC 269-1-2 standards



Ratings:

- Volts: - 660 / 690V ac
- 250V dc (2 - 63A)
- 400V dc (80 - 200A)
- Amps: - 2 - 200A
- IR - 80kA @ 660V ac
- 40kA @ 400V dc

Applications: Protection of large industrial installations at 600/690Vac

Agency information: Meets BS88: Part 1 & 2 and IEC 269: Parts 1 & 2

RoHS Compliant

Catalogue Numbers

Rating (A)	Catalogue Number	BS Reference	Unit Packing	CAMaster fuseholder
2	2H07-660	A2	20	CM32F
4	4H07-660			
6	6H07-660			
10	10H07-660			
16	16H07-660			
20	20H07-660			
25	25H07-660	A3	20	CM63F CM100F
32	32H07-660			
40	40K07-660			
50	50K07-660	A4	10	N/A
63	63K07-660			
80	80L14-660	N/A	5	N/A
100	100L14-660			
125	125M14-660			
160	160M14-660			
200	200M14-660			

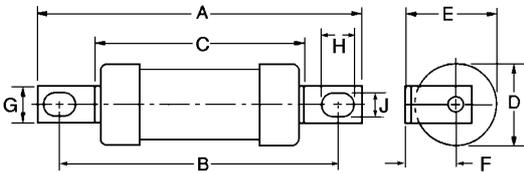

Part No	Dimensions (mm)								
	A	B	C	D	E	F	G	H	J
H07-660	82.3	73	52.0	22.0	22.4	11.5	8.7	7.7	5.4
K07-660	86.0	73	54.2	25.8	26.9	14.0	12.7	10.5	5.5
L14-660	111.0	94	67.0	35.5	37.0	19.2	19.0	10.3	8.7
M14-660	112.0	94	66.0	38.0	38.0	19.0	19.0	10.0	8.5

- Data Sheet H07: 4150
- Data Sheet K07: 4151
- Data Sheet L14: 4152
- Data Sheet M14: 4153

Industrial Applications to BS88 - 660/690V

Centre Bolted Tags
660 - 690V ac / 2 - 630A
250 - 400V dc



Specifications

Description: Fuse Links for industrial applications at 660/690V that meets dimensional and performance requirements of BS88 and IEC 269-1-2 standards.

Ratings:

- Volts: - 660 / 690V ac
- 250V dc (2 - 63A) (K08, K09)
- 400V dc (80 - 630A) (L09, M09, N09, P09, N11, P11, P12, R11, R12)
- Amps: - 2 - 630A
- IR - 80kA @ 660V ac
- 40kA @ 250V dc/400V dc

Applications: Protection of large industrial installations at 660/690Vac

Agency Information: Meets BS88: Part 1 & 2 and IEC 269: Parts 1 & 2

RoHS Compliant

Dimensions

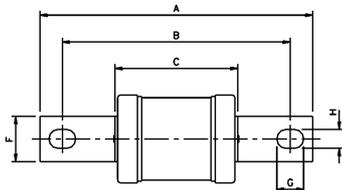

Part No	Dimensions (mm)							
	A	B	C	D	E	F	G	H
K08-660 2-32A	111.0	92.5	53.7	22.0	2.4	12.7	13.0	7.5
K08-660 40-63A	111.5	93.0	54.2	25.0				
K09-660 2-32A	127.0	111	53.7	22.0	2.4	14.0	15.2	8.7
K09-660 40-63A	128.0	111	54.2	25.0				

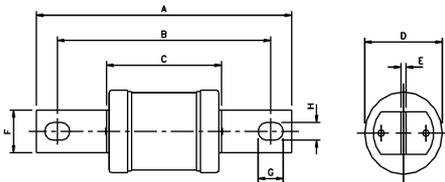

Part No	Dimensions (mm)							
	A	B	C	D	E	F	G	H
L09-660	136.0	111	65.5	35.5	3.2	19.0	15.1	8.7
M09-660	135.0	111	65.0	37.0	3.2	19.0	15.0	8.7
N09-660	135.0	111	73.0	49.0	3.2	25.4	12.7	9.5
P09-660	135.5	111	75.0	58.5	4.7	25.4	12.7	9.5
N11-660	162.0	133	73.0	49.0	3.2	25.4	15.8	10.5

Catalogue Numbers

Rating (A)	Catalogue Number	BS Reference	Fixing Centres (mm)	Unit Packing
2	2K08-660	N/A	93	20
4	4K08-660			
6	6K08-660			
10	10K08-660			
16	16K08-660			
20	20K08-660			
32	32K08-660			
40	40K08-660			
50	50K08-660			
63	63K08-660			

Rating (A)	Catalogue Number	BS Reference	Fixing Centres (mm)	Unit Packing	
2	2K09-660	N/A	111	20	
4	4K09-660				
6	6K09-660				
10	10K09-660				
16	16K09-660				
20	20K09-660				
32	32K09-660				
40	40K09-660				
50	50K09-660				
63	63K09-660				
80	80L09-660				B1
100	100L09-660				B2
125	125M09-660				
160	160M09-660				B3
200	200M09-660				
250	250N09-660	B4			
315	315N09-660				
355	355P09-660	B4			
400	400P09-660				

Rating (A)	Catalogue Number	BS Reference	Fixing Centres (mm)	Unit Packing
125	125N11-660	N/A	133	1
160	160N11-660			
200	200N11-660			
250	250N11-660			
315	315N11-660			

Rating (A)	Catalogue Number	BS Reference	Fixing Centres (mm)	Unit Packing
355	355P11-660	C1	133/184	1
400	400P11-660			
450	450R11-660	C2	133/184	1
500	500R11-660			
560	560R11-660			
630	630R11-660			

Rating (A)	Catalogue Number	BS Reference	Fixing Centres (mm)	Unit Packing
355	355P12-660	N/A	167/231	1
400	400P12-660			
450	450R12-660			
500	500R12-660			
560	560R12-660			
630	630R12-660			

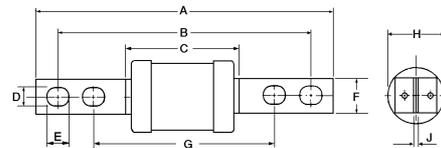

Part No	Dimensions (mm)								
	A	B	C	D	E	F	G	H	J
P11-660	212.0	184	133	75.0	25.4	16.0	10.0	59.0	5.0
P12-660	262.0	231	167						
R11-660	210.0	184	133	76.0	26.0	16.0	10.0	74.0	6.5
R12-660	262.0	231	167						

Data Sheets: K08: 415 / L09: 4156 / M09: 4157 / N09: 4158 / P09: 4159 / N11: 4160 / P11: 4161 / R11: 4162 / R12: 4162

Industrial Applications to BS88 - 660/690V

Special Tag Arrangements 660 - 690V / 125 - 800A

Specifications

Description: Fuse Links for industrial applications at 660/690V that meets dimensional and performance requirements of BS88 and IEC 269-1-2 standards.



Ratings:

- Volts: - 660 / 690V ac (except S20 type - 550V ac)
- 400V dc (except S20 type)
- Amps: - 125 - 800A
- IR - 80kA @ 660V ac
- 40kA @ 400V (except S20 type)

Applications: Protection of large industrial installations at 600 / 690Vac

Agency Information: BS88 part 1 section 2-1 & 2-2

RoHS Compliant

Dimensions

Offset Bolted Tag

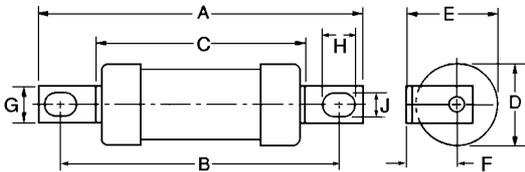

Part No	Dimensions (mm)								
	A	B	C	D	E	F	G	H	J
M13	120.0	99.0	70.0	38.0	27.0	8.0	26.0	12.0	8.7
M23	262.0	231.0	167.0		38.5	19.0		14.0	
N15	120.0	100.0	79.0	49.0	41.0	16.5		15.0	9.8

Special Tag Arrangement

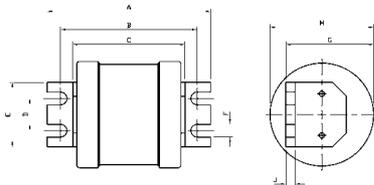

Part No	Dimensions (mm)								
	A	B	C	D	E	F	G	H	J
N20	110.0	92.0	75.0	22.0	44.5	8.8	49.0	49.0	6.4
P20	111.0		76.0				47.0	59.0	
R20	112.0	94.0	77.0				62.0	74.0	
S20	112.0		77.0				66.0	83.0	

Catalogue Numbers

Tag Types	Rating (A)	Catalogue Number	Fixing Centres (mm)	Unit Packing
Offset Bolted Tag	125	125M13	99	5
	160	160M13		
	200	200M13		
	250	250M13	231	
	315	315M13		
	125	125M23		
Offset Bolted Tag	160	160M23	100	1
	200	200M23		
	250	250N15		
Centre Bolted Tag	315	315N15	113	1
	250	250N34		
	315	315N34		
	355	355P35	133/184	
	400	400P35		
	450	450R40	133/184	
500	500R40			
Special Offset Tag	125	125N20	92.5	1
	160	160N20		
	200	200N20		
	250	250N20		
	315	315N20		
	355	355P20	92.5	
	400	400P20		
	450	450R20	94	
	500	500R20		
	560	560R20		
630	630R20			
710	710S20			
800	800S20	94		

Centre Bolted Tag

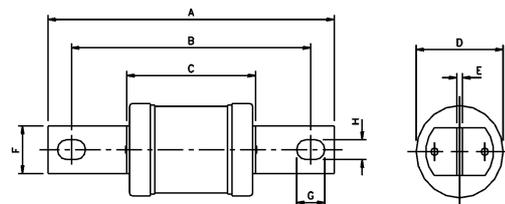

Part No	Dimensions (mm)							
	A	B	C	D	E	F	G	H
N34	135.0	111	74.5	66.5	5.0	25.4	12.5	9.5

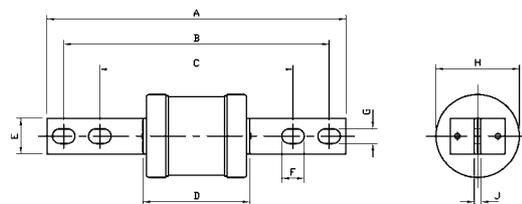

Part No	Dimensions (mm)								
	A	B	C	D	E	F	G	H	J
P35	210.0	184	133	75.0	19.0	16.0	10.0	59.0	5.0
R40				81.0				74.0	

Data Sheets: M13 & M23: 4153 / N15: 4164 / N34: 4165 / P35: 4161 / R40: 4162 / N20: 4166 / P20: 4167 / R20: 4168 / S20: E5785045

Street Lighting Applications to BS88

Offset Bolted Tags 240 - 550V / 2 - 32A

Specifications

Description: Fuse Links for general street lighting applications with Q1 fusing factor - general purpose (gG)

Applications: Street lighting applications

Ratings:

- Volts: - 240 - 415V ac
- Amps: - 2 - 32A
- IR - 33kA @ 240V ac (STD)
- 80kA @ 415 / 550V ac (SMD)

Agency information: Meets BS88: Part 1 & 2 (1988), IEC 269: Parts 1 (1986)

RoHS Compliant

SMD 415V ac (gG) / 2 - 32A



Catalogue Numbers

Rating (A)	Part Reference	Unit Packing
2	SMD2	20
4	SMD4	
6	SMD6	
10	SMD10	
16	SMD16	
20	SMD20	
25	SMD25	
32	SMD32	

Dimensions

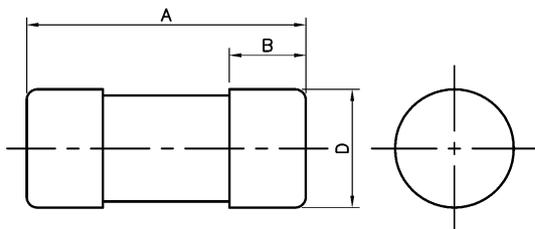

Part No	Dimensions (mm)			
	A	B	C	D
SMD	29.0	-	-	12.7

Also available as Offset Bladed Tags "SSD", see page 10

STD 240V ac / 2 - 32A



Catalogue Numbers

Rating (A)	Part Reference	Unit Packing
2	STD2	20
4	STD4	
6	STD6	
10	STD10	
16	STD16	
20	STD20	
25	STD25	
32	STD32	

Dimensions

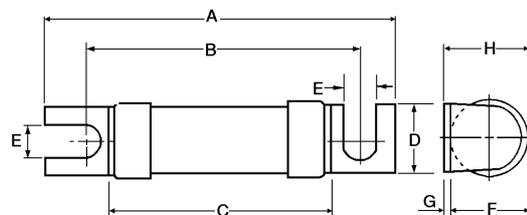

Part No	Dimensions (mm)							
	A	B	C	D	E	F	G	H
STD	47.0	35	24.0	11.0	4.7	12.0	0.8	13.0

Data Sheet: 4123

Utility Applications to BS88

House Service Cut-Out Fuse Links 415V / 5 - 100A

Specifications

Description: Cylindrical Fuse Links for electrical utilities to BS Standard

Ratings:

Volts: - 415V
Amps: - 5 - 100A
IR - 33kA @ 415V

Applications: Fuses to use in connection with House Service cut-outs.

Agency Information: ASTA certified and tested in accordance to BS 1361

RoHS Compliant

Catalogue Numbers

Rating (A)	Catalogue Number		Unit Packing
	Diameter		
	22mm	30mm	
5	5KR85	-	20
10	10KR85	-	
15	15KR85	-	
20	20KR85	-	
25	25KR85	-	
30	30KR85	30LR85	
40	40KR85	40LR85	
45	45KR85	-	
50	50KR85	50LR85	
60	60KR85	60LR85	
70	70KR85	-	
80	80KR85	80LR85	
90	90KR85	-	
100	100KR85	100LR85	

Dimensions

KR85 Type

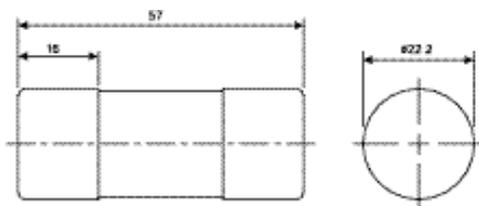

LR85 Type

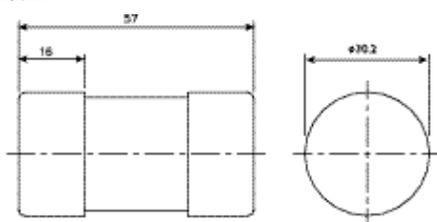

Data Sheet KR85: 4185
Data Sheet LR85: 4186

J Type Fuse Links to BS88: Part 5 Cylindrical Type 415V / 20 - 250A

Specifications

Description: Cylindrical type fuses designed for use with wedge type fuse carriers on BS applications

Ratings:

Volts: - 415V
Amps: - 20 - 250A
IR - 80kA @ 415V

Applications: For use by Electrical Authorities in distribution pillars, open type substation boards, heavy duty cut-outs, and underground connection boxes. Cylindrical type to be used in pole or wall mounted outdoor service fuse units.

Agency information: ASTA certified and tested to BS88: Part 5

RoHS Compliant

Catalogue Numbers:

Rating (A)	Catalogue Number	Unit Packing
20	20MJ25-6	20
32	32MJ25-6	
40	40MJ25-6	
63	63MJ25-6	
80	80MJ25-6	
100	100MJ25-6	
125	125MJ25-6	
160	160MJ25-6	
200	200MJ25-6	
250	250MJ25-6	

Dimensions

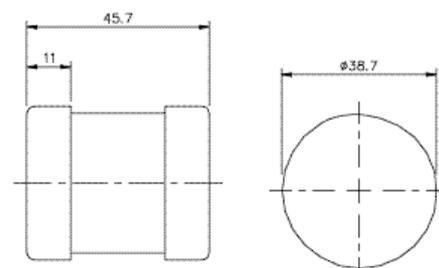

Data Sheet: 4177

Utility Applications to BS88

J Type Fuse Links to BS88: Part 5 Slotted/Non Slotted Types 415V / 20 - 800A

Specifications

Description: Slotted type fuses designed for use with wedge type fuse carriers on BS applications



Ratings:

- Volts: - 415V
- Amps: - 20 - 630A (Slotted Type)
- 800A (Non Slotted Type)
- IR - 80kA @ 415V

Applications: For use by Electrical Authorities in distribution pillars, open type substation boards, heavy duty cut-outs, and underground connection boxes.

Agency information: ASTA certified and tested BS88: Part 5

RoHS Compliant

Dimensions

Type	A	B	C	D	E	F	G	H	I	J	K
MJ30-8	110	82	45.2	40.5	30	14.8	17.5	9.8	30.9	2.4	6.45/6.53
MJ30-7 (Up to 200A)	110	82	45.2	40.5	30	14.8	17.5	9.8	30.9	2.4	6.45/6.53
MJ30-7 (315-400A)	110	82	44.8	40	30	14.4	17.5	9.8	38	2.4	6.45/6.53
MJ31-7 (Up to 200A)	131	92	46.8	40.5	41	17.4	20.7	10.9	30.8	3.2	8.05/8.73
MJ31-7 (315-400A)	131	92	46.4	40	41	17.4	20.7	10.2	38.1	3.2	8.05/8.73
PJ30-7	110	82	44.8	40	30	14.4	17.5	9.8	38	2.4	6.45/6.53
PJ31-7	131	92	46.4	40	41	17.4	20.7	10.2	38.1	3.2	8.05/8.73
RJ31-7	131	92		45	38	16.5	15.5	10.9	49.1	3.2	8.05/8.73
SJ31-6	128.5	92		44.5	38.1	16.5	20.6	11	73.3	3.2	8.05/8.73
SJ28	128.5	92		44.5	38.1	16.5	20.5		73.3	3.2	8.05/8.73

Catalogue Numbers

Rating (A)	Slotted Fixing Center			Non Slotted	Unit Packing
	76mm	82mm	92mm		
20	-	-	20MJ31-8	-	10
25	-	-	25MJ31-8	-	
32	-	32MJ30-8	32MJ31-8	-	
40	-	40MJ30-8	40MJ31-8	-	
50	-	50MJ30-8	50MJ31-8	-	
63	63MJ29-6	63MJ30-8	63MJ31-8	-	
80	80MJ29-6	80MJ30-7	80MJ31-7	-	
100	100MJ29-6	100MJ30-7	100MJ31-7	-	
125	-	125MJ30-7	125MJ31-7	-	
160	160MJ29-6	160MJ30-7	160MJ31-7	-	
200	200MJ29-6	200MJ30-7	200MJ31-7	-	
250	250MJ29-6	250MJ30-7	250MJ31-7	-	
315	-	315MJ30-7	315MJ31-7	-	
355	-	355PJ30-7	355PJ31-7	-	
400	-	400PJ30-7	400PJ31-7	-	
450	-	-	450RJ31-7	-	
500	-	-	500RJ31-7	-	
560	-	-	560SJ31-6	-	
630	-	-	630SJ31-6	-	
800	-	-	-	800SJ28	

Slotted Type (MJ31-7 up to 200A)

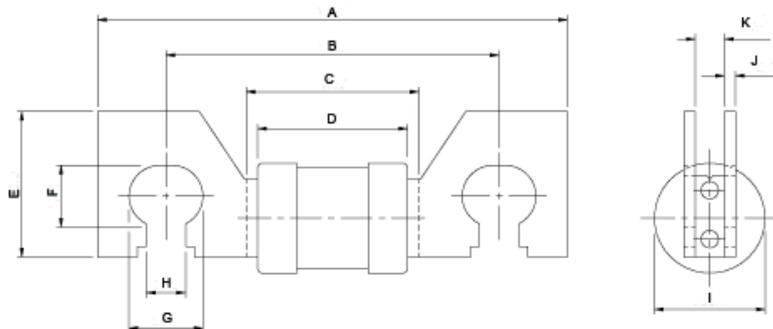

Data Sheets: MJ30-8: 4178A / MJ30-7: 4178B / MJ31-7 or 8: 4180 / PJ31: 4181 / RJ: 4182 / SJ: 4183

Joint NATO Reference System

Cylindrical/Offset Bolted Tag 440V / 0.25 - 150A



Specifications

Description: Cylindrical Fuse links originally developed for the Admiralty but are now used in a wide variety of applications

Ratings:

- Volts: - 440V
- Amps: - 0.25 - 100A (Cylindrical)
- 0.5 - 150A (Offset Bolted Tag)
- IR - 33kA @ 440Vac

Applications: defence, aeronautical, allied industries, electronics

Agency information: Defence standard 59-96 (superceding DEF 63). Tested to BS88 at 440V/33kA

RoHS Compliant

Dimensions

Cylindrical

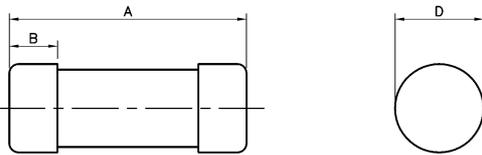

Size	A	D	B
0	32.05	6.37	5.55
1	33.6	11.86	7.14
2	37.6	16.7	8.71
3	47.9	33.3	11.9

Offset Bolted Tag

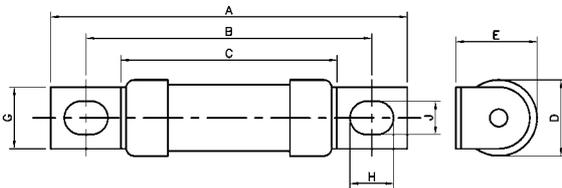

Size	A	B	C	D
1	56.03	44.65	33.9	11.96
2	70.7	55.84	37.4	16.7
3	88.6	69.77	47.4	33.3

Catalogue Numbers

Size	Rating (A)	Cylindrical	Offset Bolted	Unit Packing
0	0.25	059-0107	N/A	100
	0.5	059-0108		
	1	059-0109		
	2	059-0110		
	3	059-0111		
	5	059-0112		
	7	059-0113		
	10	059-9925		
1	15	059-9926	059-0114 059-0115 059-0116 059-0117 059-0118 059-0119 059-0120 059-0121 011-9679 012-0140	25
	0.5	059-0140		
	1	059-0141		
	2	059-0142		
	3	059-0143		
	5	059-0144		
	7	059-0145		
	10	059-0146		
	15	059-0147		
	20	011-9483		
2	30	012-0140	059-0122 059-0123 059-0124 059-0125 059-0067 011-9127 012-0141	25
	10	059-0148		
	15	059-0149		
	20	059-0150		
	30	059-0151		
	40	059-0151		
3	50	059-0152	059-0126 059-0127 059-0128 059-0129 011-9128 011-9129	25
	40	059-0152		
	50	059-0153		
	80	059-0154		
	100	059-0155		
	125	059-0155		
160	059-0155			

BS88 Fuseholders

CM

CAMASTER HRC Fuseholder 690V ac / 20 - 400A



Specifications

Description: Fully shrouded fuse bases with unique cam action system for BS88 Fuse link applications.

Ratings:

- Volts: - 660V ac
- Amps: - 20, 32 (Compact) 32, 63 and 100A

Applications: Lighting and heating equipment, circuit protection, Motor protection, Control equipment circuit protection

Agency Information: CE Compliance to BS88, EN IEC 60269. For UL and CSA approved versions also available, consult Cooper Bussmann®

RoHS Compliant

Dimensions

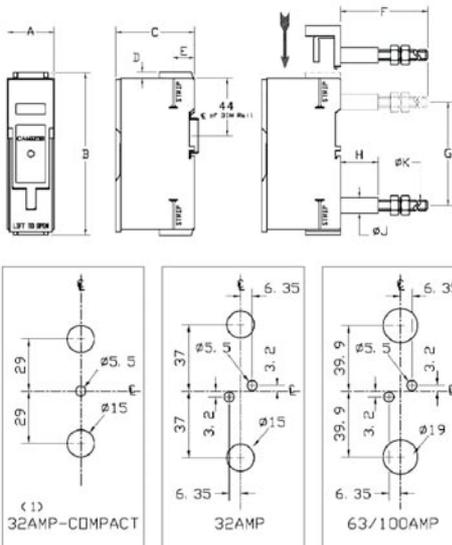

Cat. No	Max cable mm ²	Dimensions (mm)									
		A	B	C	D	E	F	G	H	J	K
CM20F	16	25.4	93.7	60	3.2	17.5	66.0	58.0	28.6	11.9	M6
CM32FC	16	25.4	93.7	60	3.2	17.5	66.0	58.0	28.6	11.9	M6
CM32F	16	31.8	117.5	60	3.2	17.5	66.0	74.0	28.6	11.9	M6
CM63F	70	35.6	125	60	4.75	16.4	86.5	81.0	28.6	11.9	M8
CM100F	70	35.6	125	60	4.75	16.4	86.5	81.0	28.6	11.9	M8
200DF	95	70	193	149	17.5	35.6	8	138	30	24	M12
400EF	240	98.4	254	192.1	31.8	36.5	-	-	-	-	-

Catalogue Numbers

Rating (A)	Catalogue Number	Recommended Fuse Link	Unit Packing
20	CM20F	NITD	10
32	CM32FC	NITD	10
32	CM32F	AAO	10
63	CM63F	BAO	10
100	CM100F	OSD	5
200*	200DF	DD	
	200DFBS Front/Back		
	200DBS Back/Back		
400*	400EF	ED	

* 200A & 400A do not have the CAM action

Accessories Numbers

Accessory	Rating (A)	Catalogue No	Unit Packing
Back Stud	32	32BSC	10
	32	32BS	10
	63/100	63/100BS	5
Ganging Links		GLP	1 set
Neon Indicator	90-415V ac	NI	3
Lockable Safety Carriers		32LSCC	3
		32LSC	3
		63/100LSC	3
Neutral Links	32	32CMLC	1
	32	32CML	
	63/100	63/100CML	
Security Clip		CMSC	20

Notes:

- 1 - Type CM32FC is also available rated at 20A, catalogue number CM20F
- 2 - For colours other than Black (standard) add the appropriate letter code: W = White; G = Green, GY = Grey
- 3 - Care must be taken when fitting solid single or stranded cables of small cross-sectional area to ensure correct clamping. Small Multi-stranded cables must be terminated with bootlace ferrules to ensure correct clamping. Bootlace ferrules should not be used on standard power cables or high current applications. If in doubt please consult Cooper Bussmann®
- 4 - A +5% tolerance should be allowed on dimensions when cutting metal work to fit CAMaster fuse holders

BS88 Fuseholders

NNS, ENS Safeloc Fuseholder 660V ac / 32 - 63A



Specifications

Description: Fuseholder to be used with BS88 Fuse links for bolted panel mounting or DIN rail.

Ratings:

Volts: - 550V ac, 415V ac (63A)
Amps: - 32, 63A

Applications: Lighting and heating equipment, circuit protection, Motor protection, Control equipment circuit protection

Agency Information: CE Compliance to BS88, EN IEC 60269

RoHS Compliant

Dimensions

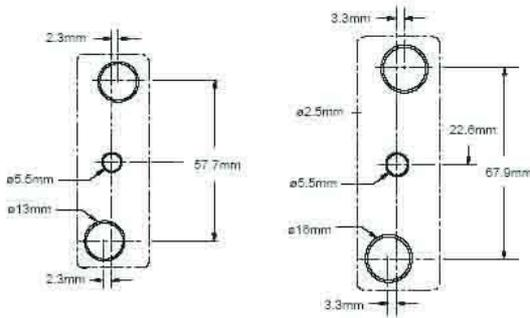

Rating (A)	Part No	Max Cable mm ²	Dimensions (mm)									
			A	B	C	D	E	F	G	H	J	K
32	NNS	16	25.4	80.3	48.5	2.3	16.0	39.2	57.7	17.0	9.7	M6
63	ENS	35	29.1	90.0	55.0	3.3	17.7	75.0	67.9	39.2	11.0	M8

Catalogue Numbers

Rating (A)	Catalogue Number	Available Variants	Required Fuse Link	Unit Packing
32	32NNSF	Front connected/ Front connected	NSD	10
	32NNSBS	Back stud/ Back stud		10
	32NNSFBS	Front connected/ Back stud		10
	32NNL	Neutral links		10
63	63ENSF	Front connected/ Front connected	ESD	5
	63ENSBS	Back stud/ Back stud		5
	63ENSFBS	Front connected/ Back stud		5
	63ENL	Neutral links		1

Notes:

1 - For colours other than Black (standard), add the appropriate letter code: W = White, G = Green, GY = Grey, at the end of the catalogue reference.

2 - Security seal (ref. 32551) available for 32A Safeloc

3 - Care must be taken when fitting solid single or stranded cables of small cross-sectional area to ensure correct clamping. Small Multi-stranded cables must be terminated with bootlace ferrules to ensure correct clamping. Bootlace ferrules should not be used on standard power cables or high current applications. If in doubt please consult Cooper Bussmann®

4 - A +5% tolerance should be allowed on dimensions when cutting metal work to fit Safeloc fuse holders

Cylindrical Domestic Fuses

Class gG (gF)
250 - 400V / 0.5 - 32A
Sizes: 6x23, 8x23, 10x25
8x31, 10x31, 8x36
10x38



Specifications

Description: Cylindrical fuses for domestic protection. Available in types with and without striker indicator.

Ratings:

- Volts: - 250V ac (6x23, 8x23, 10x25)
- 400V ac (8x31, 10x31, 8x36, 10x38)
- Amps: - 0.5 - 32A
- IR - 6kA (6x23, 8x23, 10x25)
- 20kA (8x31, 10x31, 8x36, 10x36)

Applications: Protection of power lines, heating circuits, lighting circuits. electrical domestic appliances and domestic electricity meters

Agency Information: NF C 62203, EN IEC 60269-3, NF marking (see references in bold in catalogue numbers chart)

RoHS Compliant

Dimensions

Size	A	B	C
6 x 23	6.3	23	5
8 x 23	8.5	23	5
8 x 31	8.5	31.5	6.3
8 x 36	8.5	36	6.3
10 x 25	10.3	25.8	6.3
10 x 31	10.3	31.5	6.3
10 x 38	10.3	38	10

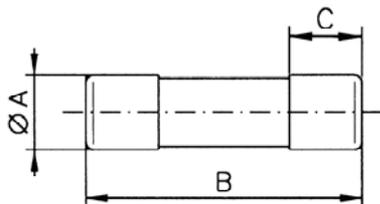

Catalogue Numbers



Size	Current (A)	References without Indicator	References with Indicator	Voltage (V)	Interrupting Rating (kA)	UP*
6x23	2	CD0623G2		250V	6kA	10
	4	CD0623G4				
	6	CD0623G6				
	10	CD0623G10				
8x23	2	CD0823G2	CD0823G2I	250V	6kA	10
	4	CD0823G4	CD0823G4I			
	6	CD0823G6	CD0823G6I			
	10	CD0823G10	CD0823G10I			
	16	CD0823G16	CD0823G16I			
10x25	6	CD1025G6	CD1025G6I	250V	6kA	10
	10	CD1025G10	CD1025G10I			
	16	CD1025G16	CD1025G16I			
8x31	0.5	CD0831G0.5	-	400V	20kA	10
	1	CD0831G1	-			
	2	CD0831G2	CD0831G2I			
	4	CD0831G4	CD0831G4I			
	6	CD0831G6	CD0831G6I			
	8	CD0831G8	CD0831G8I			
	10	CD0831G10	CD0831G10I			
	12	CD0831G12	CD0831G12I			
	16	CD0831G16	CD0831G16I			
	20	CD0831G20	CD0831G20I			
	10x31	16	CD1031G16			
20		CD1031G20	CD1031G20I			
25		CD1031G25	CD1031G25I			
8x36	2	CD0836G2	CD0836G2I	400V	20kA	12
	4	CD0836G4	CD0836G4I			
	6	CD0836G6	CD0836G6I			
	10	CD0836G10	CD0836G10I			
	16	CD0836G16	CD0836G16I			
	20	CD0836G20	CD0836G20I			
	25	CD0836G25	CD0836G25I			
	32	CD0836G32	CD0836G32I			
10x38	25	CD1038G25	CD1038G25I	400V	20kA	10
	32	CD1038G32	CD1038G32I			

*UP = Unit Packing

NFC 60203

Domestic Fuses

AD
440V ac / 15 - 90A
Sizes: 10x38, 14x51,
22x58 (cylindrical
fuses)
00 (Knife fuses)



Catalogue Numbers

Size	Current (A)	Catalogue Number	Voltage (V)	Unit Packing
10x38	15	CA10D15	440V	10
14x51	30	CA14D30		
22x58	15	CA22D15	440V	10
	30	CA22D30		
	45	CA22D45		
	60	CA22D60		
0	30	30NH00AD	440V	3
	45	45NH00AD		
	60	60NH00AD		
	90	90NH00AD		

Specifications

Description: fuse cartridge type AD for fitting to circuit breakers on low-voltage branch circuits.

Ratings:

- Volts: - 440V ac
- Amps: - 15 - 60A (Cylindrical fuses)
- 30 - 90A (Fuse size 00)
- IR - 20kA (size 10x38)
- 32kA (size 14x51, 22x58, 00)

Applications: Fitting for circuit breakers in public branch panels

Agency Information: Conform to standards NF C 62-921, EN IEC 60269

RoHS Compliant

Dimensions

Sizes	A	B	C
10x38	10.3	38	10
14x51	14.3	51	13
22x58	22.2	58	16

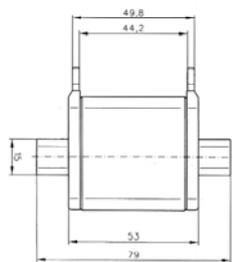
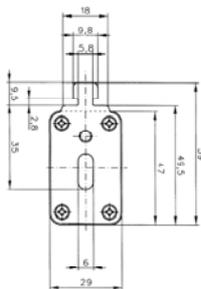

Cylindrical Industrial Fuses

Class gG
400 - 690V / 0.5 - 125A
Sizes: 8x31, 10x38,
14x51, 22x58



Specifications

Description: Cylindrical fuses for gG Industrial protection (general applications). Available with or without indicators and visual fuse activation indicator. Striker fitted to activate an auxiliary contact.

Ratings:

- Volts: - 400, 500, 690V ac
- Amps: - 0.25 - 125A
- IR - 20kA - 400V ac (size 8 x 31)
- 120kA - 400 and 500V ac
- 80 kA - 690V ac

Applications: Protection of electrical distribution circuits and electrical appliances (with the exception of electrical motors)

Agency Information: EN IEC 60269

RoHS Compliant

Dimensions

Size	A	B	C	D	E
8 x 31	8.5	31.5	6.3		
10 x 38	10.3	38	10		
14 x 51	14.3	51	13	8	4
22 x 58	22.2	58	16	8	4

Catalogue Numbers

Size	Current (A)	References without Indicator	References with Indicator	References with Striker	Voltage (V)	Disconnection power (kA)	UP*	
8 x 31	0.5	C08G0.5	-		400V	20kA	10	
	1	C08G1	-					
	2	C08G2	C08G2I					
	4	C08G4	C08G4I					
	6	C08G4	C08G4I					
	8	C08G8	C08G8I					
	10	C08G10	C08G10I					
	12	C08G12	C08G12I					
	16	C08G16	C08G16I					
	20	C08G20	C08G20I					
10 x 38	0.5	C10G0.5	-		500V	120kA	10	
	1	C10G1	-					
	2	C10G2	C10G2I					
	4	C10G4	C10G4I					
	6	C10G6	C10G6I					
	8	C10G8	C10G8I					
	10	C10G10	C10G10I					
	12	C10G12	C10G12I					
	16	C10G16	C10G16I					
	20	C10G20	C10G20I					
	25	C10G25	C10G25I					
	32	C10G32	C10G32I					
								400V
	14 x 51	2	C14G2	C14G2I	C14G2S	690V	80kA	10
4		C14G4	C14G4I	C14G4S				
6		C14G6	C14G6I	C14G6S				
8		C14G8	C14G8I	C14G8S				
10		C14G10	C14G10I	C14G10S				
12		C14G12	C14G12I	C14G12S				
16		C14G16	C14G16I	C14G16S				
20		C14G20	C14G20I	C14G20S				
25		C14G25	C14G25I	C14G25S				
32		C14G32	C14G32I	C14G32S				
40		C14G40	C14G40I	C14G40S	500V	120kA		
50		C14G50	C14G50I	C14G50S	400V			
22 x 58		2	C22G2	C22G2I		690V	80kA	10
		4	C22G4	C22G4I	C22G4S			
	6	C22G6	C22G6I	C22G6S				
	8	C22G8	C22G8I	C22G8S				
	10	C22G10	C22G10I	C22G10S				
	12	C22G12	C22G12I	C22G12S				
	16	C22G16	C22G16I	C22G16S				
	20	C22G20	C22G20I	C22G20S				
	25	C22G25	C22G25I	C22G25S				
	32	C22G32	C22G32I	C22G32S				
	40	C22G40	C22G40I	C22G40S				
	50	C22G50	C22G50I	C22G50S				
	63	C22G63	C22G63I	C22G63S				
	80	C22G80	C22G80I	C22G80S	500V	120kA		
	100	C22G100	C22G100I	C22G100S	400V			
125	C22G125	C22G125I	C22G125S	400V				

*UP: Unit Packing

Cylindrical Industrial Fuses

Class aM

400 - 690V / 0.16 - 125A

Sizes: 8 x 31, 10 x 38,
14 x 51, 22 x 58



Specifications

Description: Cylindrical fuses for aM industrial protection range (protection of motors). Available in types without indicators, with visual fuse activation indicator and plunger for activation of an auxiliary contact.

Ratings:

- Volts: - 440, 500, 690V ac
- Amps: - 0.16 - 125A
- IR - 20kA - 400V ac (size 8 x 31)
- 120kA - 400 and 500V ac
- 80kA - 690Vac

Applications: Direct protection of motors

Agency information: Conform to standard EN IEC 60269

RoHS Compliant

Dimensions

Size	A	B	C	D	E
8 x 31	8.5	31.5	6.3		
10 x 38	10.3	38	10		
14 x 51	14.3	51	13	8	4
22 x 58	22.2	58	16	8	4

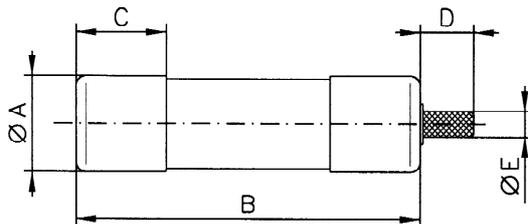

Catalogue Numbers

Size	Current (A)	References without Indicator	References with Indicator	References with striker	Voltage (V)	Disconnection power (kA)	UP*		
8 x 31	1	C8M1	C8M1I	N/A	400V	20kA	10		
	2	C8M2	C8M2I						
	4	C8M4	C8M4I						
	6	C8M6	C8M6I						
	8	C8M8	-						
10 x 38	0.16	C10M0.16	-	N/A	500V	120kA	10		
	0.25	C10M0.25	-						
	0.5	C10M0.5	-						
	1	C10M1	C10M1I						
	2	C10M2	C10M2I						
	4	C10M4	C10M4I						
	6	C10M6	C10M6I						
	8	C10M8	C10M8I						
	10	C10M10	C10M10I						
	12	C10M12	C10M12I						
	16	C10M16	C10M16I						
	20	C10M20	C10M20I						
	25	C10M25	C10M25I						
32	C10M32	-							
14 x 51	0.25	C14M0.25		N/A	500V	120kA	10		
	0.5	C14M0.50							
	1	C14M1	C14M1I						
	2	C14M2	C14M2I					C14M2S	
	4	C14M4	C14M4I					C14M4S	
	6	C14M6	C14M6I					C14M6S	
	8	C14M8	C14M8I					C14M8S	
	10	C14M10	C14M10I					C14M10S	
	12	C14M12	C14M12I					C14M12S	
	16	C14M16	C14M16I					C14M16S	
	20	C14M20	C14M20I					C14M20S	
	25	C14M25	C14M25I					C14M25S	
	32	C14M32	C14M32I					C14M32S	
	40	C14M40	C14M40I					C14M40S	
	50	C14M50	C14M50I					C14M50S	
	22 x 58	2	C22M2					C22M2I	N/A
		4	C22M4		C22M4I				
6		C22M6	C22M6I						
8		C22M8	C22M8I						
10		C22M10	C22M10I						
12		C22M12	C22M12I						
16		C22M16	C22M16I	C22M16S					
20		C22M20	C22M20I	C22M20S					
25		C22M25	C22M25I	C22M25S					
32		C22M32	C22M32I	C22M32S					
40		C22M40	C22M40I	C22M40S					
50		C22M50	C22M50I	C22M50S					
63		C22M63	C22M63I	C22M63S					
80		C22M80	C22M80I	C22M80S					
100		C22M100	C22M100I	C22M100S					
125	C22M125	C22M125I	C22M125S						
				500V	120kA				
				400V					

*UP: Unit Packing

Neutral Cartridges

8 x 31	Neutral	C8NL
10 x 38		C10NL
14 x 51		C14NL
22 x 58		C22NL

Modular Domestic Fuse Holders

CHD
250 - 400V / 10 - 32A
Sizes: 8x23, 10x25, 8x31
10x31, 10x38



Catalogue Numbers



Size	Rating (A)	Voltage (V)	Single Pole		Single Pole + Neutral		UP
			without Indicator	with Indicator	without Indicator	with Indicator	
8x23	10	250	CHD8231D	CHD8231DI	CHD8231DN	CHD8231DNI	12
10x25	16	250	CHD10251D	CHD10251DI	CHD10251DN	CHD10251DNI	12
8x31	20	400	CHD8311D	CHD8311DI	CHD8311DN	CHD8311DNI	12
10x31	25	400	CHD10311D	CHD10311DI	CHD10311DN	CHD10311DNI	12
10x38	32	400	CHD1038D	CHD1038DI	CHD1038DN	CHD1038DNI	12
Neutral	32	400	CHDND	-	-	-	12

UP: Unit Packing

Specifications

Description: Fuse Holder for domestic cylindrical fuses. Secured to DIN rail and available with light indicator for active fuse function. Range as single-pole and single-pole plus neutral in one module.

Ratings:

- Volts: - 250V ac (8x31, 10x25)
- 400V ac (8x31, 10x31, 10x38)
- Amps: - 10 - 32A
- IR - 6kA (6x23, 8x23, 10x25)
- 20kA (8x31, 10x31, 8x36, 10x38)

Applications: Protection for power lines, heating circuits, lighting circuits. electrical domestic appliances and domestic electricity meters

Agency Information: NF C 62203, EN IEC 60269-3, NF marking on all models

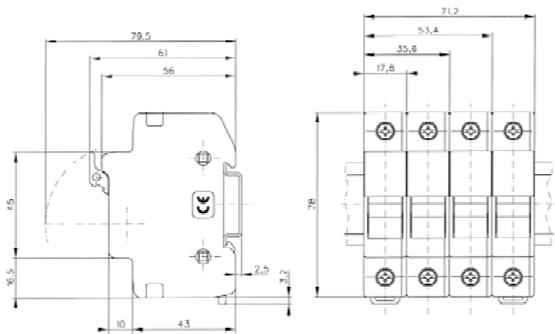

Cylindrical Industrial Fuses

CHM
690V / 25 - 32A
Sizes: 8x31, 10x38



Specifications

Description: Fuse Holder for cylindrical industrial fuses. Secured to DIN rail and available with and without light indicator for active fuse function. Range as multi-pole and single-pole plus neutral fuse holders in one module. Accessories for the assembly of modules.

Ratings:

Volts: - 690V ac
 Amps: - 25 - 32A

Applications: Protection of industrial electrical distribution circuits and electrical appliances

Agency Information: EN IEC 60269-3, EN IEC 60947

Dimensions

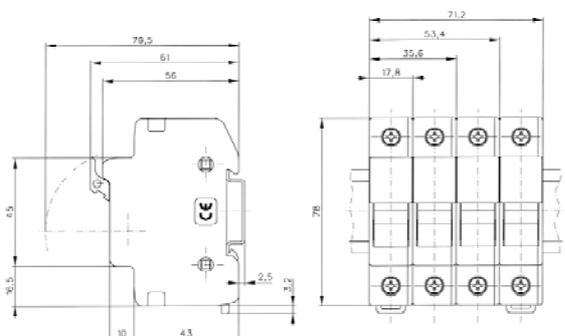

Catalogue Numbers

Size	Poles	No of Modules	References without Indicator	References with Indicator	Current (A)	Voltage (V)	Unit Packing
8 x 31	Neutral	1	CHMDNX	-	25A	690V	12
	1P	1	CH081D	CH081DI			12
	1P + N	1	CH081DNS	CH081DNSI			12
	1P + N	2	CH081DN	CH081DNI			6
	2P	2	CH082D	CH082DI			6
	3P	3	CH083D	CH083DI			4
	3P + N	3	CH083DNS	CH083DNSI			4
	3P + N	4	CH083DN	CH083DNI			3
10 x 38	Neutral	1	CHMDNX	-	32A	690V	12
	1P	1	CHM1D	CHM1DI			12
	1P + N	1	CHM1DNS	CHM1DNSI			12
	1P + N	2	CHM1DN	CHM1DNI			6
	2P	2	CHM2D	CHM2DI			6
	3P	3	CHM3D	CHM3DI			4
	3P + N	3	CHM3DNS	CHM3DNSI			4
	3P + N	4	CHM3DN	CHM3DNI			3
4P	4	CHM4D	CHM4DI	3			

Catalogue Number

Description	Size	References	Unit Packing
Clips for assembly of multi-pole fuse holders	8 x 31 - 10 x 38 - 14 x 51 - 22 x 58	AL-D	12
Multi phase handle pin connector	8 x 31 - 10 x 38	CH810-HP	12

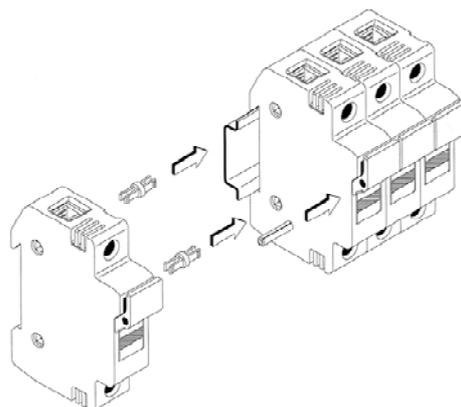

Cylindrical Industrial Fuses

CH
690V / 50 - 125A
Sizes: 14 x 51, 22 x 38



Specifications

Description: Fuse Holders for cylindrical industrial fuses. Secured to DIN rail and screwed. Available with and without light indicator for active fuse function and with auxiliary contact for use with plunger fuses. The auxiliary contact is available in two versions: one for the detection of fuse actuation and pre-disconnected, and the other fuse actuation only.

Ratings:

Volts: - 690V ac
 Amps: - 25 - 32A

Applications: Protection of industrial circuits and electrical appliances.

Agency Information: EN IEC 60269-3, EN IEC 60947

Dimensions

14 x 51

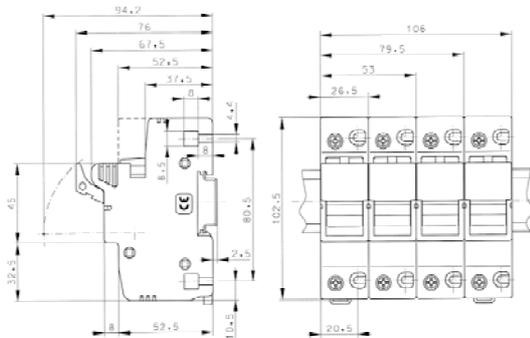

22 x 58

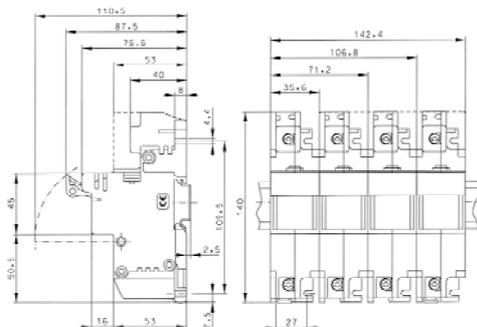

Catalogue Numbers

Size	Poles	Nb of Modules	References without Indicator	References with Indicator	References with auxiliary contact		Current (A)	Voltage (V)	UP*
					Fuse response/presence and pre-disconnect	Fuse response			
14 x 51	Neutral	1.5	CH141DNX		-	-	50A	690V	6
	1P	1.5	CH141D	CH141DI	CH141DMS-F	CH141DMS			6
	1P + N	3	CH141DN	CH141DNI	-	-			3
	2P	3	CH142D	CH142DI	-	-			3
	3P	4.5	CH143D	CH143DI	CH143DMS-F	CH143DMS			2
	3P + N	6	CH143DN	CH143DNI	CH143DNMS-F	CH143DNMS			1
22 x 58	Neutral	2	CH221DNX		-	-	125A	690V	6
	1P	2	CH221D		-	CH221DMS			6
	1P + N	4	CH221DN		-	-			3
	2P	4	CH222D		-	-			3
	3P	6	CH223D		-	CH223DMS			2
	3P + N	8	CH223DN		-	CH223DNMS			1
	4P	8	CH224D		-	-	1		

*UP: Unit Packing

Catalogue Numbers

Description	Size	Ref	UP*
Clips for assembly of multi-pole fuse holder	8x31, 10x38, 14x51,	AL-D	12
Multi phase handle Pin connector	14x51	CH14-P	12
Auxiliary contact for fuse response - 1 pole	14x51	CH14MS-1D	5
Auxiliary contact for fuse response - 3 pole	14x51	CH14MS-3D	2

*UP: Unit Packing

NH Fuses - Dual Indicator

**Class gG - Low Power Loss
400V / 2 - 630A**

**Sizes 000, 00, 01, 1, 02, 2,
03, 3**

Specifications

Description: Low Power Loss NH Fuses for industrial protection, gG range (general protection). Dual Indicator system for fuse operation function (in the body and in the side plate). Version with voltage free metal gripping lugs for insulated fuses. The components used are lead and cadmium free. Fuses subject to HRC recycling commitment.

Ratings:

Volts: - 400V ac
Amps: - 2 - 630A
IR - 120kA - 400V ac

Applications: Protection of large electric distribution networks, cables and distribution boards where the minimization of power losses is a requirement. Electrical utilities and electrical distribution networks

Standards and Approvals: Conform to standards EN IEC 60269, VDE 0636, DIN 43620, VDE approval.

Dimensions: see page 35



Catalogue Numbers

Size	Rated Current (A)	gG-gL Dual Indicator		Unit Packing
		voltage conducting gripping lugs	voltage free metal gripping lugs	
000	2	2NHG000B-400	2NHG000BI-400	3
	4	4NHG000B-400	4NHG000BI-400	3
	6	6NHG000B-400	6NHG000BI-400	3
	10	10NHG000B-400	10NHG000BI-400	3
	16	16NHG000B-400	16NHG000BI-400	3
	20	20NHG000B-400	20NHG000BI-400	3
	25	25NHG000B-400	25NHG000BI-400	3
	32	32NHG000B-400	32NHG000BI-400	3
	35	35NHG000B-400	35NHG000BI-400	3
	40	40NHG000B-400	40NHG000BI-400	3
	50	50NHG000B-400	50NHG000BI-400	3
	63	63NHG000B-400	63NHG000BI-400	3
00	80	80NHG000B-400	80NHG000BI-400	3
	100	100NHG000B-400	100NHG000BI-400	3
0	125	125NHG000B-400	125NHG000BI-400	3
	160	160NHG000B-400	160NHG000BI-400	3
01	35	35NHG01B-400	35NHG01BI-400	3
	40	40NHG01B-400	40NHG01BI-400	3
	50	50NHG01B-400	50NHG01BI-400	3
	63	63NHG01B-400	63NHG01BI-400	3
	80	80NHG01B-400	80NHG01BI-400	3
	100	100NHG01B-400	100NHG01BI-400	3
	125	125NHG01B-400	125NHG01BI-400	3
1	160	160NHG01B-400	160NHG01BI-400	3
	200	200NHG1B-400	200NHG1BI-400	3
	224	224NHG1B-400	224NHG1BI-400	3
02	250	250NHG1B-400	250NHG1BI-400	3
	35	35NHG02B-400	35NHG02BI-400	3
	40	40NHG02B-400	40NHG02BI-400	3
	50	50NHG02B-400	50NHG02BI-400	3
	63	63NHG02B-400	63NHG02BI-400	3
	80	80NHG02B-400	80NHG02BI-400	3
	100	100NHG02B-400	100NHG02BI-400	3
	125	125NHG02B-400	125NHG02BI-400	3
	160	160NHG02B-400	160NHG02BI-400	3
	200	200NHG02B-400	200NHG02BI-400	3
2	224	224NHG02B-400	224NHG02BI-400	3
	250	250NHG02B-400	250NHG02BI-400	3
	315	315NHG2B-400	315NHG2BI-400	3
	355	355NHG2B-400	355NHG2BI-400	3
03	400	400NHG2B-400	400NHG2BI-400	3
	250	250NHG03B-400	250NHG03BI-400	3
	315	315NHG03B-400	315NHG03BI-400	3
3	355	355NHG03B-400	355NHG03BI-400	3
	400	400NHG03B-400	400NHG03BI-400	3
	500	500NHG3B-400	500NHG3BI-400	3
	630	630NHG3B-400	630NHG3BI-400	3

Data Sheets: 720097 / 720099

NH Fuses - Dual Indicator

Class gG - Low Power Loss 500V / 2 - 1600A

Sizes C00, 0, 1, 2, 3, 4, 4A

Specifications

Description: Low Power Loss NH Fuses for industrial protection, gG range (general protection). Dual Indicator system for fuse operation function (in the body and in the side plate) except for the sizes 4 & 4A. Version with voltage free metal gripping lugs for insulated fuses. The components used in manufacture are lead and cadmium free. Fuses subject to HRC recycling commitment.

Ratings:

- Volts: - 500V ac
- Amps: - 2 - 1600A
- IR - 120kA - 500V ac
- 50kA - 250V dc

Applications: Protection of large electric distribution networks, cables and distribution boards (except motors) where the minimize of power losses is a requirement.

Standards and Approvals: Conform to standards EN IEC 60269, VDE 0636, DIN 43620, VDE approval.

Dimensions: see page 35



Catalogue Numbers

Size	Rated Current (A)	gG-gL Dual Indicator		Unit Packing
		voltage conducting gripping lugs	voltage free metal gripping lugs	
000	2	2NHG000B	2NHG000BI	3
	4	4NHG000B	4NHG000BI	3
	6	6NHG000B	6NHG000BI	3
	10	10NHG000B	10NHG000BI	3
	16	16NHG000B	16NHG000BI	3
	20	20NHG000B	20NHG000BI	3
	25	25NHG000B	25NHG000BI	3
	32	32NHG000B	32NHG000BI	3
	35	35NHG000B	35NHG000BI	3
	40	40NHG000B	40NHG000BI	3
	50	50NHG000B	50NHG000BI	3
00	63	63NHG000B	63NHG000BI	3
	80	80NHG000B	80NHG000BI	3
00	100	100NHG000B	100NHG000BI	3
	125	125NHG000B	125NHG000BI	3
00	160	160NHG000B	160NHG000BI	3
	10	10NHG00B	-	3
0	16	16NHG00B	-	3
	20	20NHG00B	-	3
	25	25NHG00B	-	3
	32	32NHG00B	-	3
	35	35NHG00B	-	3
	40	40NHG00B	-	3
	50	50NHG00B	-	3
	63	63NHG00B	-	3
	80	80NHG00B	-	3
	100	100NHG00B	-	3
	125	125NHG00B	-	3
160	160NHG00B	-	3	
01	10	10NHG01B	10NHG01BI	3
	16	16NHG01B	16NHG01BI	3
	20	20NHG01B	20NHG01BI	3
	25	25NHG01B	25NHG01BI	3
	32	32NHG01B	32NHG01BI	3
	35	35NHG01B	35NHG01BI	3
	40	40NHG01B	40NHG01BI	3
	50	50NHG01B	50NHG01BI	3
	63	63NHG01B	63NHG01BI	3
	80	80NHG01B	80NHG01BI	3
	100	100NHG01B	100NHG01BI	3
125	125NHG01B	125NHG01BI	3	
160	160NHG01B	160NHG01BI	3	
1	200	200NHG1B	200NHG1BI	3
	224	224NHG1B	224NHG1BI	3
	250	250NHG1B	250NHG1BI	3
02	35	35NHG02B	35NHG02BI	3
	40	40NHG02B	40NHG02BI	3
	50	50NHG02B	50NHG02BI	3
	63	63NHG02B	63NHG02BI	3
	80	80NHG02B	80NHG02BI	3
	100	100NHG02B	100NHG02BI	3
	125	125NHG02B	125NHG02BI	3
	160	160NHG02B	160NHG02BI	3
	200	200NHG02B	200NHG02BI	3
	224	224NHG02B	224NHG02BI	3
250	250NHG02B	250NHG02BI	3	
2	315	315NHG2B	315NHG2BI	3
	355	355NHG2B	355NHG2BI	3
	400	400NHG2B	400NHG2BI	3
03	250	250NHG03B	250NHG03BI	3
	315	315NHG03B	315NHG03BI	3
	355	355NHG03B	355NHG03BI	3
3	400	400NHG03B	400NHG03BI	3
	500	500NHG3B	500NHG3BI	3
	630	630NHG3B	630NHG3BI	3
4	500	500NHG4G	-	3
	630	630NHG4G	-	3
	800	800NHG4G	-	3
	1000	1000NHG4G	-	3
	1250	1250NHG4G	-	3
4A	630	630NH4AG	-	3
	800	800NH4AG	-	3
	900	900NH4AG	-	3
	1000	1000NH4AG	-	3
	1250	1250NH4AG	-	3
None Slotted End Tags	1600	1600NH4AG	-	3

Data Sheets: 2142

NH Fuses - Dual Indicator

Class gG
690V / 2 - 630A

Sizes 000, 00, 0, 1, 2, 3

Specifications

Description: NH Fuses for gG range industrial protection (general protection). Double indicator system for fuse operation (in the body and in the side plate). Version with voltage free metal gripping lugs for insulated fuses. The components used in manufacture are lead and cadmium free. Fuses subject to HRC recycling commitment.

Ratings:

Volts: - 690V ac
Amps: - 2 - 630A
IR - 120kA - 690V ac

Applications: Protection of electrical distribution circuits, cables and electrical appliances (with the exception of motors).

Standards and Approvals: Conform to standards EN IEC 60269, VDE 0636, DIN 43620.

Dimensions: see page 35



Catalogue Numbers

Size	Rated Current (A)	gG - gL Dual Indicator		Unit Packing		
		voltage conducting gripping lugs	voltage free metal gripping lugs			
000	2	2NHG000B-690	2NHG000BI-690	3		
	4	4NHG000B-690	4NHG000BI-690			
	6	6NHG000B-690	6NHG000BI-690			
	10	10NHG000B-690	10NHG000BI-690			
	16	16NHG000B-690	16NHG000BI-690			
	20	20NHG000B-690	20NHG000BI-690			
	25	25NHG000B-690	25NHG000BI-690			
	32	32NHG000B-690	32NHG000BI-690			
	35**	35NHG000B-690	35NHG000BI-690			
00	40	40NHG000B-690	40NHG000BI-690	3		
	50	50NHG00B-690	50NHG00BI-690			
	63	63NHG00B-690	63NHG00BI-690			
	80	80NHG00B-690	80NHG00BI-690			
0	100	100NHG00B-690	100NHG00BI-690	3		
	6	6NHG0B-690	-			
	10	10NHG0B-690	-			
	16	16NHG0B-690	-			
	20	20NHG0B-690	-			
	25	25NHG0B-690	-			
	32	32NHG0B-690	-			
	35	35NHG0B-690	-			
	40	40NHG0B-690	-			
	50	50NHG0B-690	-			
1	63	63NHG0B-690	-	3		
	80	80NHG0B-690	-			
	100	100NHG0B-690	-			
	125	125NHG0B-690	-			
	160	160NHG0B-690	-			
	200	200NHG0B-690	-			
	63	63NHG1B-690	63NHG1BI-690			
	80	80NHG1B-690	80NHG1BI-690			
	100	100NHG1B-690	100NHG1BI-690			
	125	125NHG1B-690	125NHG1BI-690			
	160	160NHG1B-690	160NHG1BI-690			
	200	200NHG1B-690	200NHG1BI-690			
	2	63	63NHG2B-690		63NHG2BI-690	3
		80	80NHG2B-690		80NHG2BI-690	
100		100NHG2B-690	100NHG2BI-690			
125		125NHG2B-690	125NHG2BI-690			
160		160NHG2B-690	160NHG2BI-690			
200		200NHG2B-690	200NHG2BI-690			
224		224NHG2B-690	224NHG2BI-690			
3	250	250NHG2B-690	250NHG2BI-690	3		
	315	315NHG2B-690	315NHG2BI-690			
	250	250NHG3B-690	250NHG3BI-690*			
	315	315NHG3B-690	315NHG3BI-690*			
	355	355NHG3B-690	355NHG3BI-690*			
	400	400NHG3B-690	400NHG3BI-690*			
3	500	500NHG3B-690	500NHG3BI-690*	3		
	630	-	-			

* Contact Cooper Bussmann for availability

** Interrupting Rating for the 35 A size 000 is 80kA

NH Fuses - Dual Indicator

Class aM
500 - 690V / 2 - 630A

Sizes 000, 00, 0, 1, 2, 3A



Specifications

Description: NH Fuses for aM range industrial protection (general protection). Double indicator system for fuse operation (in the body and in the side plate). Version with voltage free metal gripping lugs for insulated fuses.

The components used in manufacture are lead and cadmium free. Fuses subject to HRC recycling commitment.

Ratings:

- Volts: - 690V ac
- Amps: - 25 - 32A
- IR - 80 kA - 500Vac (sizes 000,00 - up to 100A)
- 120kA - 500Vac/690Vac

Applications: Protection of electrical motors.

Standards and Approvals: Conform to standards EN IEC 60269, VDE 0636, DIN 43620.

Dimensions: see page 35

Catalogue Numbers

Size	Rated Current (A)	aM Dual Indicator		Unit Packing
		voltage conducting gripping lugs	voltage free metal gripping lugs	
000	2	-	-	3
	4	-	-	
	6	6NHM000B-690	6NHM000BI-690	
	10	10NHM000B-690	10NHM000BI-690	
	16	16NHM000B-690	16NHM000BI-690	
	20	20NHM000B-690	20NHM000BI-690	
	25	25NHM000B-690	25NHM000BI-690	
	32	32NHM000B-690	32NHM000BI-690	
00	35	35NHM000B-690	35NHM000BI-690	3
	40	40NHM000B-690	40NHM000BI-690	
	50	50NHM00B	50NHM00BI	
	63	63NHM00B	63NHM00BI	
	80	80NHM00B	80NHM00BI	
0	100	100NHM00B	100NHM00BI	3
	160	160NHM00B	160NHM00BI	
	6	6NHM0B	-	
	10	10NHM0B	-	
	16	16NHM0B	-	
	20	20NHM0B	-	
	25	25NHM0B	-	
	32	32NHM0B	-	
	35	35NHM0B	-	
	40	40NHM0B	-	
1	50	50NHM0B	-	3
	63	63NHM0B	-	
	80	80NHM0B	-	
	100	100NHM0B	-	
	125	125NHM1B	125NHM1BI	
	160	160NHM1B	160NHM1BI	
	200	200NHM1B	200NHM1BI	
	224	224NHM1B	224NHM1BI	
2	250	250NHM1B	250NHM1BI	3
	63	-	-	
	80	-	-	
	100	-	-	
	125	125NHM2B-690	125NHM2BI-690	
	160	160NHM2B-690	160NHM2BI-690	
	200	200NHM2B-690	200NHM2BI-690	
	224	224NHM2B-690	224NHM2BI-690	
	250	250NHM2B-690	250NHM2BI-690	
3	315	315NHM2B-690	315NHM2BI-690	3
	355	355NHM2B-690	355NHM2BI-690	
	400	400NHM2B	400NHM2BI	
	250	-	-	
	315	315NHM3B-690	315NHM3BI-690	
	355	355NHM3B-690	355NHM3BI-690	
3	400	400NHM3B-690	400NHM3BI-690	3
	500	500NHM3B-690	500NHM3BI-690	
	630	630NHM3B	630NHM3BI	

NH Fuses

Class aM
500V / 2 - 630A

Sizes C00, 0, 1, 2, 3



Specifications

Description: NH Fuses for aM range industrial protection (general protection). Indicator for fuse activation in the side panel. The components used in manufacture are lead and cadmium free. Fuses subject to HRC recycling commitment.

Ratings:

- Volts: - 500V ac
- Amps: - 2 - 630A
- IR - 120kA - 500Vac
- 50kA - 250V dc

Applications: Protection of direct starter motors

Standards and Approvals: Conform to standards EN IEC 60269, VDE 0636, DIN 43620.

Dimensions: see page 35

Catalogue Numbers

Size	Rated current (A)	Voltage conducting gripping lugs	Disconnect Power (kA)	Unit Packing
C00	2	2NHC00M	120kA	3
	4	4NHC00M		
	6	6NHC00M		
	10	10NHC00M		
	16	16NHC00M		
	20	20NHC00M		
	25	25NHC00M		
	32	32NHC00M		
	40	40NHC00M		
	50	50NHC00M		
00	63	63NH00M	120kA	3
	80	80NH00M		
	100	100NH00M		
	125	125NH00M		
	160	160NH00M		
0	32	32NH0M	120kA	3
	50	50NH0M		
	63	63NH0M		
	80	80NH0M		
	100	100NH0M		
	125	125NH0M		
	160	160NH0M		
1	40	40NH1M	120kA	3
	50	50NH1M		
	63	63NH1M		
	80	80NH1M		
	100	100NH1M		
	125	125NH1M		
	160	160NH1M		
	200	200NH1M		
250	250NH1M			
2	100	100NH2M	120kA	3
	125	125NH2M		
	160	160NH2M		
	200	200NH2M		
	250	250NH2M		
	315	315NH2M		
	355	355NH2M		
400	400NH2M			
3	315	315NH3M	120kA	3
	400	400NH3M		
	500	500NH3M		
	630	630NH3M		

NH Fuses with Striker

Class gG - aM
500 - 690V / 63 - 1250A

Sizes 1, 2, 3, 4



Specifications

Description: NH Fuses for industrial applications class gG and aM with integrated side striker for visual or remote indication of the fuse status. To be used with NH fuse holders fitted with micro-switch.

Ratings:

- Volts: - 500V ac Size 4
 - 690V ac Size 1,2,3
 Current - 63A - 1250A
 IR - 120kA - 500V ac
 - 80kA - 690V ac

Applications: Protection of electrical distribution circuits (Class gG) and motor protection (Class aM)

Standards and Approvals: Conform to standards EN IEC 60269, VDE 0636, DIN 43620.

Catalogue Numbers

Size	Rated Current (A)	gG	aM	Pack Qty
		Voltage conducting metal gripping lugs	Voltage conducting metal gripping lugs	
1	63	63NHG1BS-690*	63NHM1BS-690*	3
	80	80NHG1BS-690*	80NHM1BS-690*	
	100	100NHG1BS-690*	100NHM1BS-690*	
	125	125NHG1BS-690*	125NHM1BS-690*	
	160	160NHG1BS-690*	160NHM1BS-690*	
	200	200NHG1BS-690*	200NHM1BS-690*	
	224	-	224NHM1BS-690*	
250	-	250NHM1BS-690*		
2	125	125NHG2BS-690*	125NHM2BS-690*	3
	160	160NHG2BS-690*	160NHM2BS-690*	
	200	200NHG2BS-690*	200NHM2BS-690*	
	224	224NHG2BS-690*	224NHM2BS-690*	
	250	250NHG2BS-690*	250NHM2BS-690*	
	315	315NHG2BS-690*	315NHM2BS-690*	
	355	-	355NHM2BS-690*	
400	-	400NHM2BS-690*		
3	315	315NHG3BS-690*	-	3
	355	355NHG3BS-690*	-	
	400	400NHG3BS-690*	400NHM3BS-690*	
	500	500NHG3BS-690*	500NHM3BS-690*	
	630	630NHG3BS-690*	630NHM3BS-690*	
4	500	500NH4G-S	-	3
	630	630NH4G-S	-	
	800	800NH4G-S	-	
	1000	1000NH4G-S	-	
	1250	1250NH4G-S	-	

* Contact Cooper Bussmann for availability

NH Fuses - Dimensions

Knife Fuses (NH)

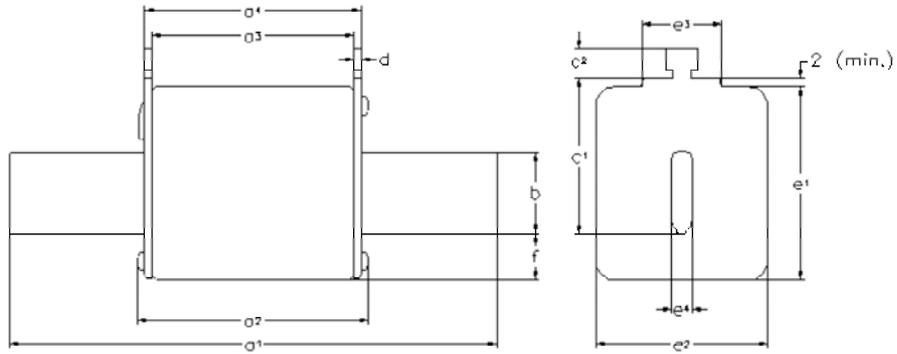

Size a	a1	a2 (max)	a3	a4	b (rated)	c1(±8)	c2 (rated)	D (rated)	e1 (max)	e2 (max)	e3 (max)	e4 (rated)	f (max)
000	78.5±1.5	54	45±1.5	49±1.5	15	35	10	2±0.5	48	30	25	6	15
00	78.5±1.5	54	45±1.5	49±1.5	15	35	11	2±0.5	48	30	25	6	15
0	125±2.5	68	62± ^{+3/} _{-1.5}	68± ^{+1.5/} ₋₃	15	35	11	2.5±0.5	48	30	25	6	15
01	135±2.5	75	62±2.5	68±2.5	15	40	11	2.5±0.5	48	30	25	6	15
1	135±2.5	75	62±2.5	68±2.5	20	40	11	2.5±0.5	53	52	25	6	15
02	150±2.5	75	62±2.5	68±2.5	20	48	11	2.5±0.5	53	52	25	6	15
2	150±2.5	75	62±2.5	68±2.5	25	48	11	2.5±0.5	61	60	25	6	15
03	150±2.5	75	62±2.5	68±2.5	25	60	11	2.5±0.5	61	60	25	6	15
3	150±2.5	75	62±2.5	68±2.5	32	60	11	3±0.5	76	60	25	6	18
4a	200	84	80	90	50	85		3	102	87			30
4a -1600A	200	84	80	90	50	85		3	102	87			30

NH Fuse Holders for Knife Fuses

SB-D, SB-S, SB-DMS
690V / 160 - 1600A

Sizes 00, 0, 1, 2, 3, 4



Specifications

Description: Knife fuses, NH, thermoplastic bodies for knife fuses. Securing to DIN rail and by screws (size 4 screw fixation only). Range of protection accessories for live parts in order to obtain IP20 protection standard. Available with micro-switch contact for use with fuses with striker (see page 30).

Ratings:

- Volts: - up to 690V ac
- Amps: - 2 - 1600A

Applications: Protection of industrial circuits and electrical apparatus

Standards and Approvals: IEC 60269, VDE 0636, DIN 43620

Dimensions

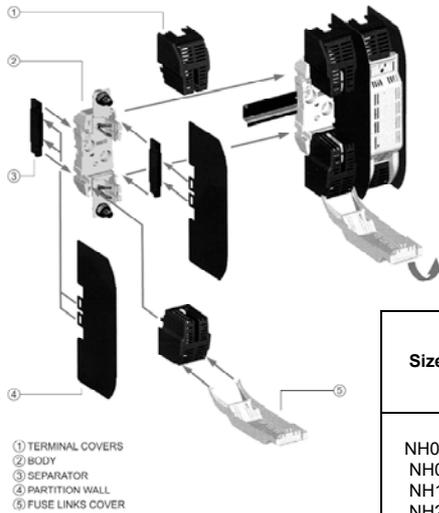

Catalogue Numbers

Size	Poles	Current (A)	Part References		With micro-switch contact	UP*
			Screw connection	DIN Rail connection		
00	1 3	160A	SB00-S TB00-S	SB00-D TB00-D TB00-D-IP20		3 1 1
0	1 3	160A	SB0-S TB0-S	SB0-D TB0-D	SB0-DMS	3 1
1	1 3	250A	SB1-S TB1-S	SB1-D TB1-D	SB1-DMS	3 1
2	1 3	400A	SB2-S TB2-S	SB2-D TB2-D	SB2-DMS	3 1
3	1 3	630A	SB3-S TB3-S	SB3-D TB3-D	SB3-DMS	3 1
4	1	1600A	SB4-S		SB4-DMS	3

Neutral

Size	Current (A)	Part Ref	Unit Packing
NH00	160	SL00	3
NH0	160	SL0	
NH1	250	SL1	
NH2	400	SL2	
NH3	630	SL3	
NH4	1000	SL4	

Fuse extraction handle

Size	Part Ref	Unit Packing
C00-3	FEH	1

Protection accessories

Size	Current (A)	Separation Partition ④		Fuse Cover ⑤		Terminal Cover ①		Separator ③	
		Part Ref	Unit Packing	Part Ref	Unit Packing	Part Ref	Unit Packing	Part Ref	Unit Packing
NH00	160A	SP00	2	FC00	3	CS00	6	BC00	2
NH0	160A	SP0	2	FC0	3	CS0	6	BC0	2
NH1	250A	SP1-2	2	FC1	3	CS1	6	BC1-2	2
NH2	400A	SP1-2	2	FC2	3	CS2	6	BC1-2	2
NH3	630A	SP3	2	FC3	3	CS3	6	BC3	2
NH4	1250A	SP4	2						

IP Protection Kits

TB00-D-IP20	Complete triple pole fuse base IP20 rated
FPK0-3P	IP20 kit for TB0-D fuse base
FPK1-3P	IP20 kit for TB1-D fuse base
FPK2-3P	IP20 kit for TB2-D fuse base
FPK3-3P	IP20 kit for TB3-D fuse base

Dimensions for Knife Fuses and Fuseholders NH

Knife Fuseholders (NH)

Bases for fuseholders with micro circuit-breaker

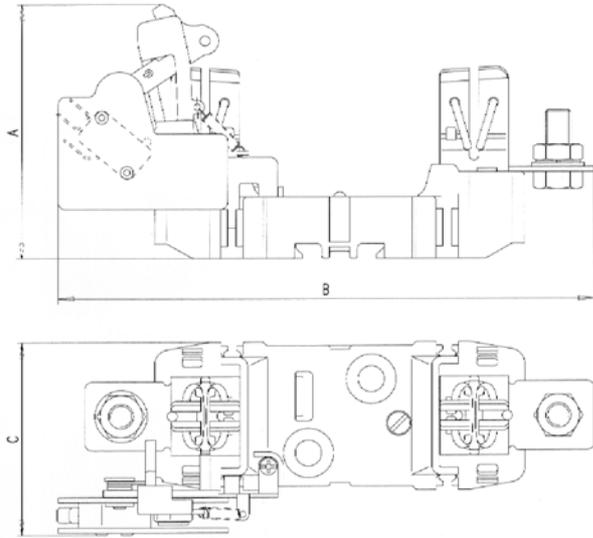

Size	A	B	C
NH0	90	193	65.5
NH1	98	215	76
NH2	102	227	76
NH3	102	235	76
NH4	140	284	113

NH Fuse Rail

Vertical Style BFRD 690V / 250-630A

Sizes 1, 2, 3

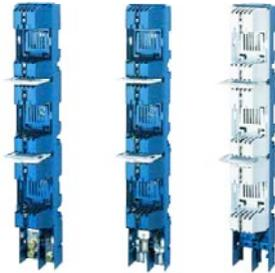

Specifications

Description: Vertical Fuse Rails are designed to be used with NH Fuses. Fully protected against accidental contacts.

Main features are:

- Contact covers
- Inter polar barriers
- Label for protected circuit identification
- Busbar mounting with screws

Ratings:

Volts: - 690V ac
Amps: - 250 - 630A

Applications: Disconnecting cabinets and low voltage distribution switchboards with busbar spacing of 185mm

Standards and Approvals: CE, IEC EN 60269-1, IEC EN 60269-3-1

Dimensions:

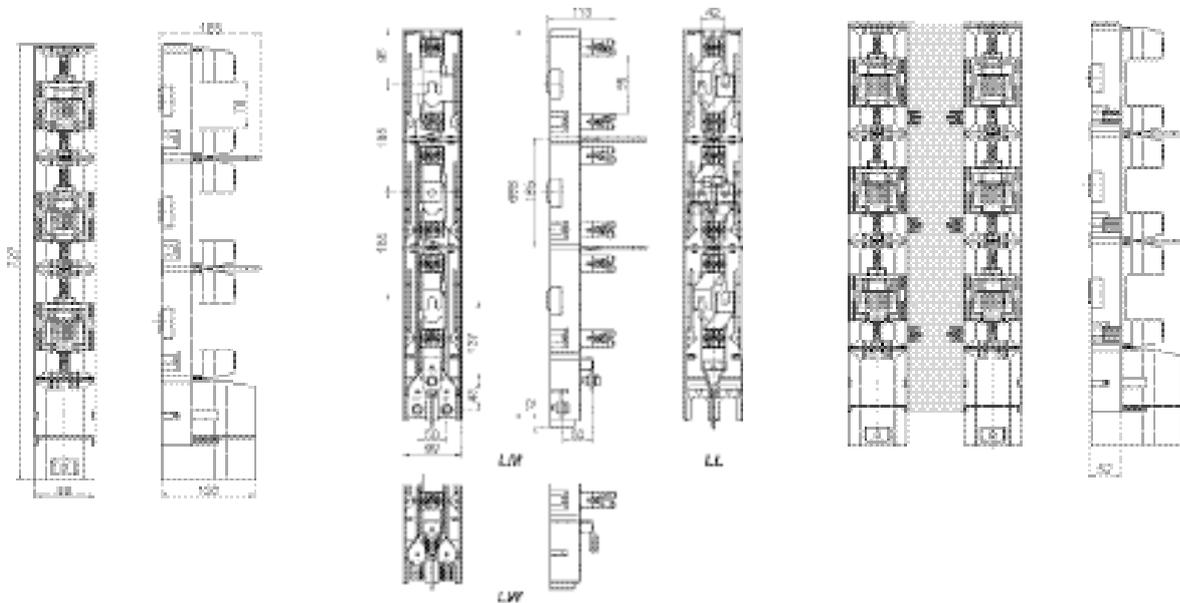

Catalogue Numbers

Size	Rating (A)	Part Reference	Leading out Terminals
1	250	BFR1-3K/LM/C (*)	Pressed-in Nuts with M10 Screw
		BFR1-3K/LW	V-Shaped Clamps
		BFR1-3K/LL	Busbar Systems 185mm Busbar Spacing Connects to Busbar with M12 bolts
2	400	BFR2-3K/LM/C (*)	Pressed-in Nuts with M10 Screw
		BFR2-3K/LW	V-Shaped Clamps
		BFR2-3K/LL	Busbar Systems 185mm Busbar Spacing Connects to Busbar with M12 bolts
3	630	BFR3-3K/LM/C (*)	Pressed-in Nuts with M10 Screw
		BFR3-3K/LW	V-Shaped Clamps
		BFR3-3K/LL	Busbar Systems 185mm Busbar Spacing Connects to Busbar with M12 bolts

(*) with Leading-out Terminal cover

DO Fuses

Class gG
400V / 2 - 100A

Sizes D01, D02, D03



Specifications

Description: DO fuses, gG range, for industrial and domestic protection. All the fuses incorporate a visual display of fuse actuation. Additional range of fuse holders and accessories.

Ratings:

- Volts: - 690V ac
- Amps: - 160 - 1600A
- IR - 50kA - 400V ac

Applications: Protection of electrical distribution circuits, cables and electrical apparatus (with the exception of motors).

Standards and Approvals: IEC 60269, VDE 0636,

Catalogue Numbers

Size	Current (A)	Colour Code	Part Ref	Voltage (V)	Disconnection Power (kA)	Unit Packing
D01	2	Pink	2NZ01	400V	100kA	10
	4	Brown	4NZ01			
	6	Green	6NZ01			
	10	Red	10NZ01			
	16	Grey	16NZ01			
D02	20	Blue	20NZ02	400V	100kA	10
	25	Yellow	25NZ02			
	35	White	35NZ02			
	50	Black	50NZ02			
	63	Copper	63NZ02			
D03	80	Silver	80NZ03	400V	100kA	10
	100	Red	100NZ03			

Dimensions

D01

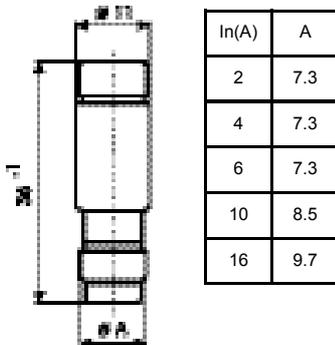

D02

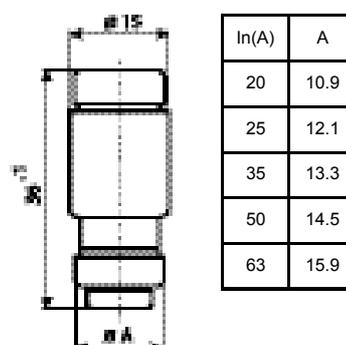

D03

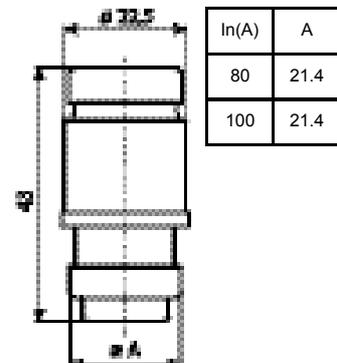

DO Fuseholders

FN C , TFN C, FRN C, TFRN C
400V / 16 - 100A

Sizes D01, D02, D03



Specifications

Description: DO fuse carriers in ceramic bodies with versions for securing to DIN rail or screw connection. Complete range of accessories.

Ratings:

Volts: - 400V ac
 Amps: - 16 - 100A

Applications: Protection of industrial circuits and electrical apparatus.

Standards and Approvals: IEC 60269, VDE 0636,

Dimensions

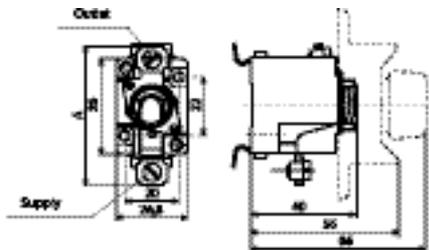

Size	A
DO1	53
DO2	57

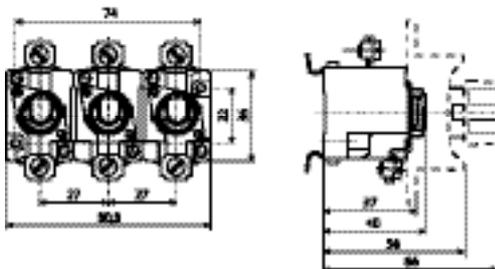

Catalogue Numbers

Size	Current (A)	Part Ref Screw Connection		Part Ref DIN Rail Connection		Unit Packing
		Single Pole	Three Pole	Single Pole	Three Pole	
DO1	16A	FN01C	TFN01C	FRN01C	TFRN1C	15/5 (Three Pole)
DO2	63A	FN02C	TFN02C	FRN02C	TFRN2C	15/5 (Three Pole)

Accessories

Accessories	Size	Current (A)	Fuse Base Type	References	Unit Packing
Fuse Carrier	DO1 DO2	16 63	E14 E18	CN01 CN02	20
Gauge/Calibration ring	DO1	2 4 6 10	E14	2GN01 4GN01 6GN01 10GN01	50
	DO2	16 20 25 35 50	E18	16GN02 20GN02 25GN02 35GN02 50GN02	
Covers	DO1 1 pole	16	E14	SFPCDO1	50
	DO2 1 pole	63	E18	SFPCDO2	
	DO1 3 pole	16	E14	TFPCDO1	30
	DO2 3 pole	63	E18	TFPCDO2	

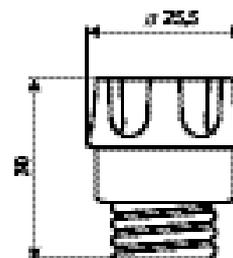
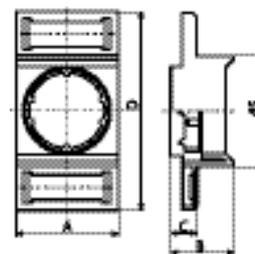

D Fuses

**Class gG
500V / 2 - 200A**

Sizes: DI, DII, DIII, DIV, DV



Specifications

Description: D fuses, gG range, for industrial and domestic protection. All the fuses incorporate a visual display of fuse actuation. Additional range of fuse holders and accessories.

Ratings:

- Volts: - 690V ac
- Amps: - 2 - 200A
- IR - 50kA - 500V ac

Applications: Protection of electrical distribution circuits, cables and electrical apparatus (with the exception of motors).

Standards and Approvals: IEC 60269, VDE 0636,

Dimensions

Catalogue Numbers

Size	Current (A)	Colour Code	References	Voltage (V)	Disconnection Power (kA)	Unit Packing
DI	2	Pink	2D16	500V	100kA	10
	4	Brown	4D16			
	6	Green	6D16			
	10	Red	10D16			
	16	Grey	16D16			
	20	Blue	20D16			
	25	Yellow	25D16			
DII	2	Pink	2D27	500V	100kA	10
	4	Brown	4D27			
	6	Green	6D27			
	10	Red	10D27			
	16	Grey	16D27			
	20	Blue	20D27			
	25	Yellow	25D27			
DIII	35	Black	35D33	500V	100kA	10
	50	White	50D33			
	63	Copper	63D33			
DIV	80	Silver	80D125	500V	100kA	10
	100	Red	100D125			

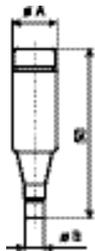

Int (A)	A	B
2	13.2	6
4		6
6		6
10		8
16		10
20		12
25		14

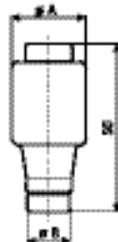

Int (A)	A	B
2	21.5	6
4		6
6		6
10		8
16		10
20		12
25		14

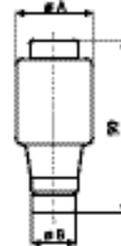

Int (A)	A	B
35	27	16
50	27	16
63	27	18

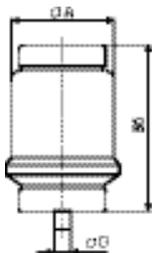

Int (A)	A	B
35	27	16
50	27	16

D Fuseholders

SFD, TFD, SFRD C , TFR
500V / 25 - 63A

Sizes: DII, DIII



Specifications

Description: D fuse carriers in ceramic bodies with versions for securing to DIN rail or screw connection. Complete range of accessories.

Ratings:

Volts: - 500V ac
 Amps: - 25 - 63A

Applications: Protection of industrial circuits and electrical apparatus.

Standards and Approvals: IEC 60269, VDE 0636,

Dimensions

Catalogue Numbers

Size	Current (A)	Part Ref Screw Connection		Part Ref DIN Rail Connection		Unit Packing
		Single Pole	Three Pole	Single Pole	Three Pole	
DI	25A	SFD27	TFD27	SFRD27	TFRD27	15/4 (Three Terminal)
DIII	63A	SFD33	TFD33	SFRD33	TFRD33	15/6 (Three Terminal)

Accessories

Accessories	Size	Current (A)	Fuse Base Type	References	Unit Packing
Fuse Carrier	DII	25A	E27	CD27	50
	DIII	63A	E33	CD33	30
Gauge/ Calibration Ring	DII	2	E27	2GD27	50
		4		4GD27	
6		6GD27			
10		10GD27			
16		16GD27			
20	20GD27				
25	25GD27				
DIII	35	E33	35GD33		
	50		50GD33		
	63		63GD33		
Covers	DII 1 pole	25	E27	SFPRD27	50
	DIII 1 pole	63	E33	SFPRD27	30
	DII 3 pole	25	E27	TFPCD27	
	DIII 3 pole	63	E33	TFPCD33	

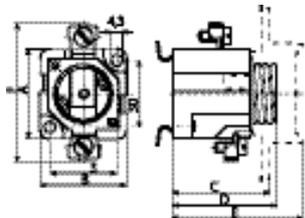

Size	A	B	C	D	E	F
DII	41	39	44	47	60	62
DIII	43	47	44	47	56	79

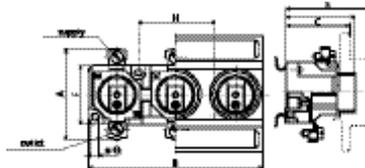

Size	A	B	C	D	E	F	G	H
DII	41	121	44	47	60	30	4.3	50
DIII	43	148	44	47	56	32	4.3	62

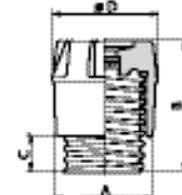

Size	A	B	C	D
DII	E	44	12	34
DIII	E	44	12	43

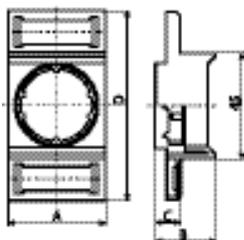

1 Pole	A	B	C	D
DII	40	24	10.8	80
DIII	49	21	9	80

3 Pole	A	B	C	D
DII	121	24	10.8	80
DIII	148	21	9	80

Other Low Voltage Fuse Ranges

North American Standard Fuses and Holders



Specifications

Description: Round fuses and holders in accordance with North American standards. Some ranges available with fuse actuation display.

Makes: CUBEFuse TM low-peak, Fusetron, Limitron, CC-Tron, Dura-LagTM, T-Tron, Optima.

Modular fuse holders (class CC, Midget and class J), fuse holders and isolator circuit-breakers.

Ratings:

Volts: - 125 to 600V ac
Amps: - 100mA to 6000A
IR - 300kA

Applications: General use for all types of protection and also motor protection.

Standards and Approvals: Classes UL and CSA certified (consult us for types)

Dimensions: Miniature, class CC, class RK5, class RK1, class J, class G, Midget, class L.

Medium Voltage Fuses and Isolators

Fuses for Voltage and Transformer Auxiliary Fuses



Specifications

Description: Medium Voltage fuses with low current values, which allow for the associated system to be isolated in the event of a fault in the transformer circuit.

Ratings:

- Volts: - 1 to 36kV ac
- Amps: - 2 - 10A
- IR - 25 - 50kA

Applications: For use in the voltage transformer primary circuit and in transformer auxiliary elements, etc.

Standards and Approvals: BS2692-1, IEC 60282-1

Dimensions: Cylindrical body fuses with various length and diameter dimensions

Other MV Fuses

DIN Fuses



Specifications

Description: Complete range of fuses (back-up, full range), and also motor protection.

Ratings:

- Volts: - 12 to 36kV ac
- Amps: - 6.3 to 160A

Dimensions: DIN 43625, EN IEC 60782-1, VDE 0670-4

Oil Fuses



Specifications

Description: Fuses for use in oil-insulated isolators and circuit breakers. Fuses fitted with a pyrotechnic plunger.

Ratings:

- Volts: - 3.6 to 24kV ac
- Amps: - 6.3 to 250A

Dimensions: BS 2692-1, ESI 12-8, EN IEC 60292-1

Starter Motor Fuses



Specifications

Description: Fuses to provide protection against short-circuit in motor and engine circuits.

Ratings:

- Volts: - 3.6 to 7.2kV ac
- Amps: - 5 to 400A

Dimensions: Conform to British Standards, Standards UL and IEC DIN 43625

Ultra Fast Fuses and Holders

British Standard Fuses and Holders



Specifications

Description: Standard British ultra-fast fuses. Possibility of adapting side indicators and auxiliary micro-switch as accessories.

Ratings:

- Volts: - 240 - 690V ac / 150 to 500V dc
- Amps: - 6 - 900A
- IR - 200ka RMS Sym

Applications: Protection of semiconductors, UPS (ASI), rectifiers, static relays, converters etc

Standards and Approvals: Conform to standards BS88-4, EN IEC 60269-5, UL recognized

Dimensions: Various fuses sizes in single or double cylindrical body

North American Standard Fuses and Holders



Specifications

Description: Standard North American ultra-fast fuses. Fuse actuation display available on external and internal versions. Limited range of fuse bases

Ratings:

- Volts: - 130 to 1000V ac / 130 to 800V dc
- Amps: - 1 to 4000A
- IR - 200kA RMS Sym

Applications: Protection of semiconductors, UPS (ASI), rectifiers, static relays, converters, etc.

Standards and Approvals: UL Recognised, CSA, Component Acceptance

Dimensions: There are no standard dimensions with these types of fuses.

Ultra Fast Fuses and Holders

Cylindrical Fuses and Holders



Specifications

Description: Ultra Fast cylindrical fuses. Standard ranges without fuses actuation indicator and ranges with fuse blown indicator. Modular fuse holders (type CH) for sizes 10x38, 14x51 and 22x58, with light display and ancillary elements. Fuse holders for size 22x58.

Ratings:

Volts: - 150 - 2000V ac / 150 to 1000V dc
 Amps: - 1 - 100A
 IR - 25 to 200kA RMS Sym

Applications: Protection of semi-conductors, UPS (ASI), rectifiers, static relays, converters.

Standards and Approvals: Conform to standards IEC 60269, UL Recognition, CSA Component Acceptance (consult us).

Dimensions: Variety of fuse sizes: from 6x32, 25x146

Square Body Fuses and Holders



Specifications

Description: Ultra Fast square-body fuses, in versions with visual indicator and striker for use with auxiliary micro-switch. Fuses in formats DIN 43620, DIN 43653 (DIN 110 and DIN 80), French standard, North American standard.

Fuse bases to DIN 43620 and 43653.

Ratings:

Volts: - 690 to 3000V ac
 Amps: - 10 to 700A
 IR - 300kA RMS Sym

Applications: Protection of semiconductors, UPS (ASI), rectifiers, static relays, converters.

Standards and Approvals: Conform to standards IEC 60269-4, UL Recognition, CSA Component Acceptance (consult us).

Dimensions: Sizes 000, 00, 0, 1*, 1, 2, 3, 4, 5

Index

Catalogue Number	Page	Catalogue Number	Page	Catalogue Number	Page	Catalogue Number	Page
011-9127	18	100NHG01B-400	25	125NHG02BI	26	16NHG000B-690	27
011-9128	18	100NHG01BI	26	125NHG02BI-400	25	16NHG000BI	26
011-9129	18	100NHG01BI-400	25	125NHG0B	26	16NHG000BI-400	25
011-9483	18	100NHG02B	26	125NHG1B-690	27	16NHG000BI-690	27
011-9679	18	100NHG02B-400	25	125NHG1BI-690	27	16NHG01B	26
012-0140	18	100NHG02BI	26	125NHG1BS-690	30	16NHG01BI	26
012-0141	18	100NHG02BI-400	25	125NHG2B-690	27	16NHG0B	26
059-0067	18	100NHG0B	26	125NHG2BI-690	27	16NHG0B-690	27
059-0107	18	100NHG0B-690	27	125NHG2BS-690	30	16NHM000B-690	28
059-0108	18	100NHG1B-690	27	125NHM00B	28	16NHM000BI-690	28
059-0109	18	100NHG1BI-690	27	125NHM00BI	28	16NHM0B	28
059-0110	18	100NHG1BS-690	30	125NHM1B	28	16NZ01	35
059-0111	18	100NHG2B-690	27	125NHM1BI	28	200DF	19
059-0112	18	100NHG2BI-690	27	125NHM1BS-690	30	200M09-660	13
059-0113	18	100NHM00B	28	125NHM2B-690	28	200M13	14
059-0114	18	100NHM00BI	28	125NHM2BI-690	28	200M14-660	12
059-0115	18	100NHM0B	28	125NHM2BS-690	30	200M23	14
059-0116	18	100NHM1B	28	15KR85	16	200MJ25-6	16
059-0117	18	100NHM1BI	28	1600NH4AG	26	200MJ29-6	17
059-0118	18	100NHM1BS-690	30	160M09-660	13	200MJ30-7	17
059-0119	18	100NZ03	35	160M13	14	200MJ31-7	17
059-0120	18	10D16	37	160M14-660	12	200N11-660	13
059-0121	18	10D27	37	160M23	14	200N20	14
059-0122	18	10GD27	38	160MJ25-6	16	200NH1M	29
059-0123	18	10GN01	36	160MJ29-6	17	200NH2M	29
059-0124	18	10H07-660	12	160MJ30-7	17	200NHG02B	26
059-0125	18	10HS07	11	160MJ31-7	17	200NHG02B-400	25
059-0126	18	10K08-660	13	160N11-660	13	200NHG02BI	26
059-0127	18	10K09-660	13	160N20	14	200NHG02BI-400	25
059-0128	18	10KR85	16	160NH00M	29	200NHG1B	26
059-0129	18	10KS09	11	160NH0M	29	200NHG1B-400	25
059-0140	18	10NHC00M	29	160NH1M	29	200NHG1B-690	27
059-0141	18	10NHG000B	26	160NH2M	29	200NHG1BI	26
059-0142	18	10NHG000B-400	25	160NHG00B	26	200NHG1BI-400	25
059-0143	18	10NHG000B-690	27	160NHG00B-400	25	200NHG1BI-690	27
059-0144	18	10NHG000BI	26	160NHG00BI	26	200NHG1BS-690	30
059-0145	18	10NHG000BI-400	25	160NHG00BI-400	25	200NHG2B-690	27
059-0146	18	10NHG000BI-690	27	160NHG01B	26	200NHG2BI-690	27
059-0147	18	10NHG01B	26	160NHG01B-400	25	200NHG2BS-690	30
059-0148	18	10NHG01BI	26	160NHG01BI	26	200NHM1B	28
059-0149	18	10NHG0B	26	160NHG01BI-400	25	200NHM1BI	28
059-0150	18	10NHG0B-690	27	160NHG02B	26	200NHM1BS-690	30
059-0151	18	10NHM000B-690	28	160NHG02B-400	25	200NHM2B-690	28
059-0152	18	10NHM000BI-690	28	160NHG02BI	26	200NHM2BI-690	28
059-0153	18	10NHM0B	28	160NHG02BI-400	25	200NHM2BS-690	30
059-0154	18	10NZ01	35	160NHG0B	26	20D16	37
059-0155	18	1250NH4AG	26	160NHG1B-690	27	20D27	37
059-9925	18	1250NH4G-S	30	160NHG1BI-690	27	20GD27	38
059-9926	18	1250NHG4G	26	160NHG1BS-690	30	20GN02	36
1000NH4AG	26	125M09-660	13	160NHG2B-690	27	20H07-660	12
1000NH4G-S	30	125M13	14	160NHG2BI-690	27	20HS07	11
1000NHG4G	26	125M14-660	12	160NHG2BS-690	30	20K08-660	13
100D125	37	125M23	14	160NHM00B	28	20K09-660	13
100KR85	16	125MJ25-6	16	160NHM00BI	28	20KR85	16
100L09-660	13	125MJ30-7	17	160NHM1B	28	20KS09	11
100L14-660	12	125MJ31-7	17	160NHM1BI	28	20MJ25-6	16
100LR85	16	125N11-660	13	160NHM1BS-690	30	20MJ31-8	17
100MJ25-6	16	125N20	14	160NHM2B-690	28	20NHCO0M	29
100MJ29-6	17	125NH00M	29	160NHM2BI-690	28	20NHG000B	26
100MJ30-7	17	125NH0M	29	160NHM2BS-690	30	20NHG000B-400	25
100MJ31-7	17	125NH1M	29	16D16	37	20NHG000B-690	27
100NH00M	29	125NH2M	29	16D27	37	20NHG000BI	26
100NH0M	29	125NHG00B	26	16GD27	38	20NHG000BI-400	25
100NH1M	29	125NHG00B-400	25	16GN02	36	20NHG000BI-690	27
100NH2M	29	125NHG00BI	26	16H07-660	12	20NHG01B	26
100NHG000B	26	125NHG00BI-400	25	16HS07	11	20NHG01BI	26
100NHG000B-400	25	125NHG01B	26	16K08-660	13	20NHG0B	26
100NHG000BI	26	125NHG01BI-400	25	16K09-660	13	20NHG0B-690	27
100NHG000BI-400	25	125NHG01BI	26	16KS09	11	20NHM000B-690	28
100NHG00B-690	27	125NHG01BI-400	25	16NHC00M	29	20NHM000BI-690	28
100NHG00BI-690	27	125NHG02B	26	16NHG000B	26	20NHM0B	28
100NHG01B	26	125NHG02B-400	25	16NHG000B-400	25	20NZ02	35

Index

Catalogue Number	Page	Catalogue Number	Page	Catalogue Number	Page	Catalogue Number	Page
224NHG02B	26	25NHG01B	26	32NHG000B-400	25	400NHG2BI	26
224NHG02B-400	25	25NHG01BI	26	32NHG000B-690	27	400NHG2BI-400	25
224NHG02BI	26	25NHG0B	26	32NHG000BI	26	400NHG3B-690	27
224NHG02BI-400	25	25NHG0B-690	27	32NHG000BI-400	25	400NHG3BI-690	27
224NHG1B	26	25NHM000B-690	28	32NHG000BI-690	27	400NHG3BS-690	30
224NHG1B-400	25	25NHM000BI-690	28	32NHG01B	26	400NHM2B	28
224NHG1B-690	27	25NHM0B	28	32NHG01BI	26	400NHM2BI	28
224NHG1BI	26	25NZ02	35	32NHG0B	26	400NHM2BS-690	30
224NHG1BI-400	25	2D16	37	32NHG0B-690	27	400NHM3B-690	28
224NHG1BI-690	27	2D27	37	32NHM000B-690	28	400NHM3BI-690	28
224NHG2B-690	27	2GD27	38	32NHM000BI-690	28	400NHM3BS-690	30
224NHG2BI-690	27	2GN01	36	32NHM0B	28	400P09-660	13
224NHG2BS-690	30	2H07-660	12	32NNL	20	400P11-660	13
224NHM1B	28	2K08-660	13	32NNSBS	20	400P12-660	13
224NHM1BI	28	2K09-660	13	32NNSF	20	400P20	14
224NHM1BS-690	30	2NHC00M	29	32NNSFBS	20	400P35	14
224NHM2B-690	28	2NHG000B	26	355NH2M	29	400PJ30-7	17
224NHM2BI-690	28	2NHG000B-400	25	355NHG03B	26	400PJ31-7	17
224NHM2BS-690	30	2NHG000B-690	27	355NHG03B-400	25	40K07-660	12
250M13	14	2NHG000BI	26	355NHG03BI	26	40K08-660	13
250MJ25-6	16	2NHG000BI-400	25	355NHG03BI-400	25	40K09-660	13
250MJ29-6	17	2NHG000BI-690	27	355NHG2B	26	40KR85	16
250MJ30-7	17	2NZ01	35	355NHG2B-400	25	40KS07	11
250MJ31-7	17	30KR85	16	355NHG2BI	26	40KS08	11
250N09-600	13	30LR85	16	355NHG2BI-400	25	40KS09	11
250N11-660	13	30NH00AD	23	355NHG3B-690	27	40LR85	16
250N15	14	315M13	14	355NHG3BI-690	27	40MJ25-6	16
250N20	14	315MJ30-7	17	355NHG3BS-690	30	40MJ30-8	17
250N34	14	315MJ31-7	17	355NHM2B-690	28	40MJ31-8	17
250NH1M	29	315N09-660	13	355NHM2BI-690	28	40NH1M	29
250NH2M	29	315N11-660	13	355NHM2BS-690	30	40NHC00M	29
250NHG02B	26	315N15	14	355NHM3B-690	28	40NHG000B	26
250NHG02B-400	25	315N20	14	355NHM3BI-690	28	40NHG000B-400	25
250NHG02BI	26	315N34	14	355P09-660	13	40NHG000B-690	27
250NHG02BI-400	25	315NH2M	29	355P11-660	13	40NHG000BI	26
250NHG03B	26	315NH3M	29	355P12-660	13	40NHG000BI-400	25
250NHG03B-400	25	315NHG03B	26	355P20	14	40NHG000BI-690	27
250NHG03BI	26	315NHG03B-400	25	355P35	14	40NHG01B	26
250NHG03BI-400	25	315NHG03BI	26	355PJ30-7	17	40NHG01B-400	25
250NHG1B	26	315NHG03BI-400	25	355PJ31-7	17	40NHG01BI	26
250NHG1B-400	25	315NHG2B	26	35D33	37	40NHG01BI-400	25
250NHG1B-690	27	315NHG2B-400	25	35GD33	38	40NHG02B	26
250NHG1BI	26	315NHG2B-690	27	35GN02	36	40NHG02B-400	25
250NHG1BI-400	25	315NHG2BI	26	35NHG000B	26	40NHG02BI	26
250NHG1BI-690	27	315NHG2BI-400	25	35NHG000B-400	25	40NHG02BI-400	25
250NHG2B-690	27	315NHG2BI-690	27	35NHG000B-690	27	40NHG0B	26
250NHG2BI-690	27	315NHG2BS-690	30	35NHG000BI	26	40NHG0B-690	27
250NHG2BS-690	30	315NHG3B-690	27	35NHG000BI-400	25	40NHM000B-690	28
250NHG3B-690	27	315NHG3BI-690	27	35NHG000BI-690	27	40NHM000BI-690	28
250NHG3BI-690	27	315NHG3BS-690	30	35NHG01B	26	40NHM0B	28
250NHM1B	28	315NHM2B-690	28	35NHG01B-400	25	450R11-660	13
250NHM1BI	28	315NHM2BI-690	28	35NHG01BI	26	450R12-660	13
250NHM1BS-690	30	315NHM2BS-690	30	35NHG01BI-400	25	450R20	14
250NHM2B-690	28	315NHM3B-690	28	35NHG02B	26	450R40	14
250NHM2BI-690	28	315NHM3BI-690	28	35NHG02B-400	25	450RJ31-7	17
250NHM2BS-690	30	32BS	19	35NHG02BI	26	45KR85	16
25D16	37	32BSC	19	35NHG02BI-400	25	45NH00AD	23
25D27	37	32CML	19	35NHG0B	26	4D16	37
25GD27	38	32CMLC	19	35NHG0B-690	27	4D27	37
25GN02	36	32H07-660	12	35NHM000B-690	28	4GD27	38
25H07-660	12	32HS07	11	35NHM000BI-690	28	4GN01	36
25HS07	11	32K08-660	13	35NHM0B	28	4H07-660	12
25KR85	16	32K09-660	13	35NZ02	35	4K08-660	13
25KS09	11	32KS09	11	400EF	19	4K09-660	13
25MJ31-8	17	32LSC	19	400NH2M	29	4NHC00M	29
25NHC00M	29	32LSCC	19	400NH3M	29	4NHG000B	26
25NHG000B	26	32MJ25-6	16	400NH3M	29	4NHG000B-400	25
25NHG000B-400	25	32MJ30-8	17	400NHG03B	26	4NHG000B-690	27
25NHG000B-690	27	32MJ31-8	17	400NHG03B-400	25	4NHG000BI	26
25NHG000BI	26	32NH0M	29	400NHG03BI	26	4NHG000BI-400	25
25NHG000BI-400	25	32NHC00M	29	400NHG03BI-400	25	4NHG000BI-690	27
25NHG000BI-690	27	32NHG000B	26	400NHG2B-400	25	4NZ01	35

Index

Catalogue Number	Page	Catalogue Number	Page	Catalogue Number	Page	Catalogue Number	Page
500NH3M	29	630NHG3BI	26	6NHG0B-690	27	AC4	8
500NH4G-S	30	630NHG3BI-400	25	6NHM000B-690	28	AC6	8
500NHG3B	26	630NHG3BS-690	30	6NHM000BI-690	28	AD10	8
500NHG3B-400	25	630NHG4G	26	6NHM0B	28	AD16	8
500NHG3B-690	27	630NHHM3B	28	6NZ01	35	AD2	8
500NHG3BI	26	630NHHM3BI	28	70KR85	16	AD20	8
500NHG3BI-400	25	630NHHM3BS-690	30	710S20	14	AD25	8
500NHG3BI-690	27	630R11-660	13	800NH4AG	26	AD32	8
500NHG3BS-690	30	630R12-660	13	800NH4G-S	30	AD4	8
500NHG4G	26	630R20	14	800NHG4G	26	AD6	8
500NHHM3B-690	28	630SJ31-6	17	800S20	14	BAO35	6
500NHHM3BI-690	28	63D33	37	800SJ28	17	BAO40	6
500NHHM3BS-690	30	63ENL	20	80D125	37	BAO50	6
500R11-660	13	63ENSBS	20	80KR85	16	BAO63	6
500R12-660	13	63ENSF	20	80L09-660	13	BAO63M100	6
500R20	14	63ENSFBS	20	80L14-660	12	BAO63M80	6
500R40	14	63GD33	38	80LR85	16	BC0	32
500RJ31-7	17	63K07-660	12	80MJ25-6	16	BC00	32
50D33	37	63K08-660	13	80MJ29-6	17	BC1-2	32
50GD33	38	63K09-660	13	80MJ30-7	17	BC3	32
50GN02	36	63KS07	11	80MJ31-7	17	BC40	8
50K07-660	12	63KS08	11	80NH00M	29	BC50	8
50K08-660	13	63KS09	11	80NH0M	29	BC63	8
50K09-660	13	63MJ25-6	16	80NH1M	29	BC63M100	8
50KR85	16	63MJ29-6	17	80NHG000B	26	BC63M80	8
50KS07	11	63MJ30-8	17	80NHG000B-400	25	BD40	8
50KS08	11	63MJ31-8	17	80NHG000BI	26	BD50	8
50KS09	11	63NH00M	29	80NHG000BI-400	25	BD63	8
50LR85	16	63NH0M	29	80NHG00B-690	27	BFD1-31/LL	40
50MJ30-8	17	63NH1M	29	80NHG00BI-690	27	BFD1-31/LM	40
50MJ31-8	17	63NHG000B	26	80NHG01B	26	BFD1-31/LW	40
50NH0M	29	63NHG000B-400	25	80NHG01B-40	25	BFD1-33/LL	40
50NH1M	29	63NHG000BI	26	80NHG01BI	26	BFD1-33/LM	40
50NHC00M	29	63NHG000BI-400	25	80NHG01BI-400	25	BFD1-33/LW	40
50NHG000B	26	63NHG00B-690	27	80NHG02B	26	BFD2-31/LL	40
50NHG000B-400	25	63NHG00BI-690	27	80NHG02B-400	25	BFD2-31/LM	40
50NHG000BI	26	63NHG01B	26	80NHG02BI	26	BFD2-31/LW	40
50NHG000BI-400	25	63NHG01B-400	25	80NHG02BI-400	25	BFD2-33/LL	40
50NHG00B-690	27	63NHG01BI	26	80NHG0B	26	BFD2-33/LM	40
50NHG00BI-690	27	63NHG01BI-400	25	80NHG0B-690	27	BFD2-33/LW	40
50NHG01B	26	63NHG02B	26	80NHG1B-690	27	BFD3-31/LL	40
50NHG01B-400	25	63NHG02B-400	25	80NHG1BI-690	27	BFD3-31/LM	40
50NHG01BI	26	63NHG02BI	26	80NHG1BS-690	30	BFD3-31/LW	40
50NHG01BI-400	25	63NHG02BI-400	25	80NHG2B-690	27	BFD3-33/LL	40
50NHG02B	26	63NHG0B	26	80NHG2BI-690	27	BFD3-33/LM	40
50NHG02B-400	25	63NHG0B-690	27	80NHM00B	28	BFD3-33/LW	40
50NHG02BI	26	63NHG1B-690	27	80NHM00BI	28	BFH000-1A/T	41
50NHG02BI-400	25	63NHG1BI-690	27	80NHM0B	28	BFH000-3A/T	41
50NHG0B	26	63NHG1BS-690	30	80NHM1B	28	BFH00-1A/F	41
50NHG0B-690	27	63NHG2B-690	27	80NHM1BI	28	BFH00-3A/F	41
50NHG1B-690	27	63NHG2BI-690	27	80NHM1BS-690	30	BFH1-1A/F	41
50NHG1BI-690	27	63NHHM00B	28	80NZ03	35	BFH1-3A/F	41
50NHHM00B	28	63NHHM00BI	28	900NH4AG	26	BFH2-1A/F	41
50NHHM00BI	28	63NHHM0B	28	90KR85	16	BFH2-3A/F	41
50NHHM0B	28	63NHHM1B-690	28	90NH00AD	23	BFH3-1A/F	41
50NZ02	35	63NHHM1BI-690	28	AAO10	5	BFH3-3A/F	41
560R11-660	13	63NHHM1BS-690	30	AAO16	5	BFR1-3K/LL	39
560R12-660	13	63NZ02	35	AAO2	5	BFR1-3K/LM/C	39
560R20	14	6D16	37	AAO20	5	BFR1-3K/LW	39
560SJ31-6	17	6D27	37	AAO25	5	BFR2-3K/LL	39
5KR85	16	6GD27	38	AAO32	5	BFR2-3K/LM/C	39
60KR85	16	6GN01	36	AAO32M40	5	BFR2-3K/LW	39
60LR85	16	6H07-660	12	AAO32M50	5	BFR3-3K/LL	39
60NH00AD	23	6K08-660	13	AAO32M63	5	BFR3-3K/LM/C	39
63/100BS	19	6K09-660	13	AAO4	5	BFR3-3K/LW	39
63/100CML	19	6NHC00M	29	AAO6	5	C08G0.5	21
63/100LSC	19	6NHG000B	26	AC10	8	C08G1	21
630NH3M	29	6NHG000B-400	25	AC16	8	C08G10	21
630NH4AG	26	6NHG000B-690	27	AC2	8	C08G10I	21
630NH4G-S	30	6NHG000BI	26	AC20	8	C08G12	21
630NHG3B	26	6NHG000BI-400	25	AC25	8	C08G12I	21
630NHG3B-400	25	6NHG000BI-690	27	AC32	8	C08G16	21

Index

Catalogue Number	Page	Catalogue Number	Page	Catalogue Number	Page	Catalogue Number	Page
C08G16I	21	C14G20I	21	C180-2A	4	C22M32	22
C08G2	21	C14G20S	21	C180-3A	4	C22M32I	22
C08G20	21	C14G25	21	C180-5A	4	C22M32S	22
C08G20I	21	C14G25I	21	C180-7A	4	C22M4	22
C08G25	21	C14G25S	21	C22G10	21	C22M40	22
C08G25I	21	C14G2I	21	C22G100	21	C22M40I	22
C08G2I	21	C14G2S	21	C22G100I	21	C22M40S	22
C08G4	21	C14G32	21	C22G100S	21	C22M4I	22
C08G4I	21	C14G32I	21	C22G10I	21	C22M50	22
C08G6	21	C14G32S	21	C22G10S	21	C22M50I	22
C08G6I	21	C14G4	21	C22G12	21	C22M50S	22
C08G8	21	C14G40	21	C22G12S	21	C22M6	22
C08G8I	21	C14G40I	21	C22G125I	21	C22M63	22
C10G0.5	21	C14G40S	21	C22G125S	21	C22M63I	22
C10G1	21	C14G45S	21	C22G12I	21	C22M63S	22
C10G10	21	C14G4I	21	C22G12S	21	C22M6I	22
C10G10I	21	C14G4S	21	C22G16	21	C22M8	22
C10G12	21	C14G50	21	C22G16I	21	C22M80	22
C10G12I	21	C14G50I	21	C22G16S	21	C22M80I	22
C10G16	21	C14G50S	21	C22G2	21	C22M80S	22
C10G16I	21	C14G6	21	C22G20	21	C22M8I	22
C10G2	21	C14G6I	21	C22G20I	21	C22NL	22
C10G20	21	C14G6S	21	C22G20S	21	C3030	4
C10G20I	21	C14G8	21	C22G25	21	C4545	4
C10G25	21	C14G8I	21	C22G25I	21	C55	4
C10G25I	21	C14G8S	21	C22G25S	21	C8M10	22
C10G2I	21	C14M0.25	22	C22G2I	21	C8M10I	22
C10G32	21	C14M0.50	22	C22G32	21	C8M12	22
C10G32I	21	C14M1	22	C22G32I	21	C8M12I	22
C10G4	21	C14M10	22	C22G32S	21	C8M16	22
C10G4I	21	C14M10I	22	C22G4	21	C8M16I	22
C10G6	21	C14M10S	22	C22G40	21	C8M2	22
C10G6I	21	C14M12	22	C22G40I	21	C8M20	22
C10G8	21	C14M12I	22	C22G40S	21	C8M20I	22
C10G8I	21	C14M12S	22	C22G4I	21	C8M25	22
C10M0.16	22	C14M16	22	C22G4S	21	C8M2I	22
C10M0.25	22	C14M16I	22	C22G50	21	C8M4	22
C10M0.5	22	C14M16S	22	C22G50I	21	C8M4I	22
C10M1	22	C14M1I	22	C22G50S	21	C8M6	22
C10M10	22	C14M2	22	C22G6	21	C8M6I	22
C10M10I	22	C14M20	22	C22G63	21	C8M8	22
C10M12	22	C14M20I	22	C22G63I	21	C8NL	22
C10M12I	22	C14M20S	22	C22G63S	21	CA10D15	23
C10M16	22	C14M25	22	C22G6I	21	CA14D30	23
C10M16I	22	C14M25I	22	C22G6S	21	CA22D15	23
C10M1I	22	C14M25S	22	C22G8	21	CA22D30	23
C10M2	22	C14M2I	22	C22G80	21	CA22D45	23
C10M20	22	C14M2S	22	C22G80I	21	CA22D60	23
C10M20I	22	C14M32	22	C22G80S	21	CD0623G2	22
C10M25	22	C14M32I	22	C22G8I	21	CD0623G4	22
C10M25I	22	C14M32S	22	C22G8S	21	CD0623G6	22
C10M2I	22	C14M4	22	C22M10	22	CD0823G10	22
C10M32	22	C14M40	22	C22M100	22	CD0823G10I	22
C10M32I	22	C14M40I	22	C22M100I	22	CD0823G16	22
C10M4	22	C14M40S	22	C22M100S	22	CD0823G16I	22
C10M4I	22	C14M4I	22	C22M10I	22	CD0823G2	22
C10M6	22	C14M4S	22	C22M12	22	CD0823G2I	22
C10M6I	22	C14M50	22	C22M125	22	CD0823G4	22
C10M8	22	C14M50I	22	C22M125I	22	CD0823G4I	22
C10M8I	22	C14M50S	22	C22M125S	22	CD0823G6	22
C10NL	22	C14M6	22	C22M12I	22	CD0823G6I	22
C14G10	21	C14M6I	22	C22M16	22	CD0831G0.5	22
C14G10I	21	C14M6S	22	C22M16I	22	CD0831G1	22
C14G10S	21	C14M8	22	C22M16S	22	CD0831G10	22
C14G12	21	C14M8I	22	C22M2	22	CD0831G10I	22
C14G12I	21	C14M8S	22	C22M20	22	CD0831G12	22
C14G12S	21	C14NL	22	C22M20I	22	CD0831G12I	22
C14G16	21	C1515	4	C22M20S	22	CD0831G16	22
C14G16I	21	C1520	4	C22M25	22	CD0831G2	22
c14G16S	21	C180-10A	4	C22M25I	22	CD0831G20	22
C14G2	21	C180-13A	4	C22M25S	22	CD0831G20I	22
C14G20	21	C180-1A	4	C22M2I	22	CD0831G25	22

Index

Catalogue Number	Page	Catalogue Number	Page	Catalogue Number	Page	Catalogue Number	Page
CD0831G25I	22	CH141DI	24	ED250	8	M-CEO100	11
CD0831G2I	22	CH141DMS	24	ED315	8	M-CEO80	11
CD0831G4	22	CH141DMS-F	24	ED315M400	8	M-CM100F	11
CD0831G4I	22	CH141DN	24	ED355	8	M-CM20F	11
CD0831G6	22	CH141DNI	24	ED400	8	M-CM32F	11
CD0831G6I	22	CH141DNX	24	ED400M500	8	M-CM32FC	11
CD0831G8	22	CH142D	24	EF355	9	M-CM63F	11
CD0836G10	22	CH142DI	24	EF400	9	M-NITD10	11
CD0836G10I	22	CH143D	24	EF400M500	9	M-NITD16	11
CD0836G16	22	CH143DI	24	EFS125	9	M-NITD2	11
CD0836G16I	22	CH143DMS	24	EFS160	9	M-NITD20	11
CD0836G2	22	CH143DMS-F	24	EFS200	9	M-NITD32	11
CD0836G20	22	CH143DN	24	EFS250	9	M-NITD6	11
CD0836G20I	22	CH143DNI	24	EFS315	9	M-NSD10	11
CD0836G25	22	CH143DNMS	24	ESD10	10	M-NSD16	11
CD0836G25I	22	CH143DNMS-F	24	ESD16	10	M-NSD20	11
CD0836G2I	22	CH144D	24	ESD2	10	M-NSD32	11
CD0836G32	22	CH144DI	24	ESD20	10	M-NSD4	11
CD0836G32I	22	CH14-HP	24	ESD32	10	M-NSD6	11
CD0836G4	22	CH14MS-1D	24	ESD4	10	M-STD10	11
CD0836G4I	22	CH14MS-3D	24	ESD40	10	M-STD6	11
CD0836G6	22	CH221D	24	ESD50	10	NI	19
CD0836G6I	22	CH221DMS	24	ESD6	10	NITD10	5
CD100	8	CH221DN	24	ESD63	10	NITD16	5
CD100M125	8	CH221DNX	24	ESD63M100	10	NITD2	5
CD100M160	8	CH222D	24	ESD63M80	10	NITD20	5
CD100M200	8	CH223D	24	FC0	32	NITD20M25	5
CD1025G10	22	CH223DMS	24	FC00	32	NITD20M32	5
CD1025G10I	22	CH223DN	24	FC1	32	NITD25	5
CD1025G16	22	CH224D	24	FC2	32	NITD32	5
CD1025G16I	22	CH22MDNMS	24	FC3	32	NITD32M40	5
CD1025G6	22	CH810-HP	23	FEH	32	NITD32M50	5
CD1025G6I	22	CHM1D	23	FF400	9	NITD32M63	5
CD1031G16	22	CHM1DI	23	FF500	9	NITD4	5
CD1031G16I	22	CHM1DN	23	FF560	9	NITD6	5
CD1031G20	22	CHM1DNI	23	FF630	9	NSD10	10
CD1031G20I	22	CHM1DNS	23	FG450	9	NSD16	10
CD1031G25	22	CHM1DNSI	23	FG500	9	NSD2	10
CD1031G25I	22	CHM2D	23	FG560	9	NSD20	10
CD1038G25	22	CHM2DI	23	FG630	9	NSD20M25	10
CD1038G25I	22	CHM3D	23	FN01C	36	NSD20M32	10
CD1038G32	22	CHM3DI	23	FN02C	36	NSD20M36	10
CD1038G32I	22	CHM3DN	23	FRN01C	36	NSD32	10
CD27	38	CHM3DNI	23	FRN02C	36	NSD32M36	10
CD33	38	CHM3DNS	23	GF1000	9	NSD32M40	10
CD80	8	CHM3DNSI	23	GF1250	9	NSD32M50	10
CEO100	6	CHM4D	23	GF710	9	NSD32M63	10
CEO100M125	6	CHM4DI	23	GF800	9	NSD4	10
CEO100M160	6	CHMDNX	23	GG1000	9	NSD6	10
CEO100M200	6	CM100F	19	GG1250	9	OSD100	7
CEO32	6	CM20F	19	GG710	9	OSD100M125	7
CEO40	6	CM32F	19	GG800	9	OSD100M160	7
CEO50	6	CM32FC	19	GH1000	9	OSD80	7
CEO63	6	CM63F	19	GH1250	9	SB00-D	32
CEO80	6	CMSC	19	GH710	9	SB0-D	32
CH081D	23	CN01	36	GH800	9	SB0-DMS	32
CH081DI	23	CN02	36	GLP	19	SB1-D	32
CH081DN	23	CS0	32	LBS4/1	41	SB1-DMS	32
CH081DNI	23	CS00	32	LBS4/3	41	SB2-D	32
CH081DNS	23	CS1	32	M-32NNSF	11	SB2-DMS	32
CH081DNSI	23	CS2	32	M-63ENSF	11	SB3-D	32
CH082D	23	CS3	32	M-AAO10	11	SB3-DMS	32
CH082DI	23	DD125	8	M-AAO16	11	SB4-DMS	32
CH083D	23	DD160	8	M-AAO20	11	SB4-S	32
CH083DI	23	DD200	8	M-AAO25	11	SFD27	38
CH083DN	23	DD200M250	8	M-BAO40	11	SFD33	38
CH083DNI	23	DD200M315	8	M-BAO50	11	SFPCDO1	36
CH083DNS	23	DEO125	7	M-BAO63	11	SFPCDO2	36
CH083DNSI	23	DEO160	7	M-C180-13A	11	SFPRD27	38
CH084D	23	DEO200	7	M-C180-3A	11	SFPRD33	38
CH084DI	23	DEO200M250	7	M-C180-5A	11	SFRD27	38
CH141D	24	DEO200M315	7	M-CD100	11	SFRD33	38

Cooper Bussmann® Products and Technical Support Delivered Worldwide

Customer Assistance

Customer Satisfaction Team

The Cooper Bussmann® Customer Satisfaction Team is available to answer questions regarding Cooper Bussmann® products and services.

Contact should be made between:
Monday to Friday: 7:30am to 5:30pm GMT

The Customer Satisfaction Team can be reached via:

- Phone: 00 44 (0) 1509 882 600
- Fax: 00 44 (0) 1509 882 786
- Email: sales@cooperbussmann.co.uk

Application Engineering

Application Engineering assistance is available to all customers. The Application Engineering team is staffed by degreed electrical engineers and available by phone with technical and application support Monday to Friday: 7:30am to 5:30pm GMT.

Application Engineering can be reached via:

- Phone: 00 44 (0) 1509 882 699
- Fax: 00 44 (0) 1509 882 794
- Email: technical@cooperbussmann.co.uk

Web Services

www.cooperbussmann.com

The Cooper Bussmann® website makes available free information and other resources that include:

- Product Data Sheets for complete technical information on Cooper Bussmann® products
- Online catalogue for the latest United States and European catalogues
- Safety BASCIS™ for the essentials of electrical safety
- Training modules for increasing skill levels of customers and end users
- Fuse Cross-reference to find the correct Cooper Bussmann® replacement for a competitive fuse
- Arc-Flash calculator to determine the incident energy level and flash protection boundary along with the recommendations the level of Personal Protective Equipment (PPE)

Your authorised Cooper Bussmann® Distributor is:



Cooper Bussmann (UK) Ltd ● Burton-on-the-Wolds, Loughborough ●
Leicestershire LE12 5TH, UK
Tel: 00 44 (0) 1509 882 600 ● Fax: 00 44 (0) 1509 882 786
Email: sales@cooperbussmann.co.uk ● Website: www.cooperbussmann.com



Reorder: LV-2007

Данный компонент на территории Российской Федерации

Вы можете приобрести в компании MosChip.

Для оперативного оформления запроса Вам необходимо перейти по данной ссылке:

<http://moschip.ru/get-element>

Вы можете разместить у нас заказ для любого Вашего проекта, будь то серийное производство или разработка единичного прибора.

В нашем ассортименте представлены ведущие мировые производители активных и пассивных электронных компонентов.

Нашей специализацией является поставка электронной компонентной базы двойного назначения, продукции таких производителей как XILINX, Intel (ex.ALTERA), Vicor, Microchip, Texas Instruments, Analog Devices, Mini-Circuits, Amphenol, Glenair.

Сотрудничество с глобальными дистрибьюторами электронных компонентов, предоставляет возможность заказывать и получать с международных складов практически любой перечень компонентов в оптимальные для Вас сроки.

На всех этапах разработки и производства наши партнеры могут получить квалифицированную поддержку опытных инженеров.

Система менеджмента качества компании отвечает требованиям в соответствии с ГОСТ Р ИСО 9001, ГОСТ РВ 0015-002 и ЭС РД 009

Офис по работе с юридическими лицами:

105318, г.Москва, ул.Щербаковская д.3, офис 1107, 1118, ДЦ «Щербаковский»

Телефон: +7 495 668-12-70 (многоканальный)

Факс: +7 495 668-12-70 (доб.304)

E-mail: info@moschip.ru

Skype отдела продаж:

moschip.ru

moschip.ru_4

moschip.ru_6

moschip.ru_9