

ZXMHC6A07N8

60V SO8 Complementary enhancement mode MOSFET H-Bridge

Summary

| Device | $V_{(BR)DSS}$ | Q_G | $R_{DS(on)}$ | I_D $T_A = 25^\circ C$ |
|--------|---------------|-------|--------------------------|-----------------------------|
| N-CH | 60V | 3.2nC | 0.25Ω @ $V_{GS} = 10V$ | 1.8A |
| | | | 0.35Ω @ $V_{GS} = 4.5V$ | 1.5A |
| P-CH | -60V | 5.1nC | 0.40Ω @ $V_{GS} = -10V$ | -1.4A |
| | | | 0.60Ω @ $V_{GS} = -4.5V$ | -1.2A |

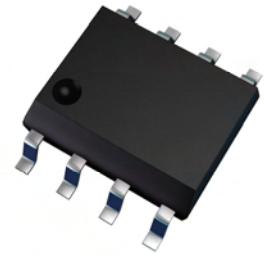

Description

This new generation complementary MOSFET H-Bridge features low on-resistance achievable with low gate drive.

Features

- 2 x N + 2 x P channels in a SOIC package

Applications

- DC Motor control
- DC-AC Inverters

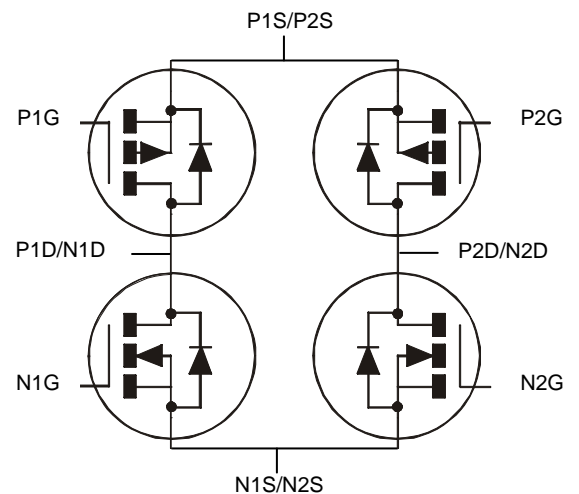

Ordering information

| Device | Reel size (inches) | Tape width (mm) | Quantity per reel |
|---------------|--------------------|-----------------|-------------------|
| ZXMHC6A07N8TC | 13 | 12 | 2,500 |

Device marking

ZXMHC
6A07

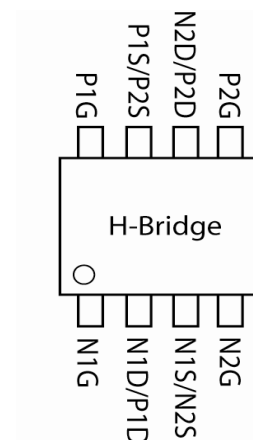

Absolute maximum ratings

| Parameter | Symbol | N-channel | P-channel | Unit |
|---|----------------|------------------------------|----------------------------------|---------------------|
| Drain-Source voltage | V_{DSS} | 60 | -60 | V |
| Gate-Source voltage | V_{GS} | ± 20 | ± 20 | V |
| Continuous Drain current @ $V_{GS}=10V$; $T_A=25^\circ C$ ^(b) @ $V_{GS}=10V$; $T_A=70^\circ C$ ^(b) @ $V_{GS}=10V$; $T_A=25^\circ C$ ^(a) @ $V_{GS}=10V$; $T_L=25^\circ C$ ^(f) | I_D | 1.80 1.40 1.39 1.42 | -1.42 -1.28 -1.28 -1.33 | A |
| Pulsed Drain current @ $V_{GS}=10V$; $T_A=25^\circ C$ ^(c) | I_{DM} | 7.10 | -6.03 | A |
| Continuous Source current (Body diode) at $T_A=25^\circ C$ ^(b) | I_S | 1.00 | -1.00 | A |
| Pulsed Source current (Body diode) at $T_A=25^\circ C$ ^(c) | I_{SM} | 7.10 | -6.03 | A |
| Power dissipation at $T_A=25^\circ C$ ^(a) Linear derating factor | P_D | 0.87 6.94 | | W mW/ $^\circ C$ |
| Power dissipation at $T_A=25^\circ C$ ^(b) Linear derating factor | P_D | 1.36 10.9 | | W mW/ $^\circ C$ |
| Power dissipation at $T_L=25^\circ C$ ^(f) Linear derating factor | P_D | 0.90 7.19 | | W mW/ $^\circ C$ |
| Operating and storage temperature range | T_j, T_{stg} | -55 to 150 | | $^\circ C$ |

Thermal resistance

| Parameter | Symbol | Value | Unit |
|------------------------------------|-----------------|-------|--------------|
| Junction to ambient ^(a) | $R_{\theta JA}$ | 144 | $^\circ C/W$ |
| Junction to ambient ^(b) | $R_{\theta JA}$ | 92 | $^\circ C/W$ |
| Junction to ambient ^(d) | $R_{\theta JA}$ | 106 | $^\circ C/W$ |
| Junction to ambient ^(e) | $R_{\theta JA}$ | 254 | $^\circ C/W$ |
| Junction to lead ^(f) | $R_{\theta JL}$ | 139 | $^\circ C/W$ |

NOTES:

- For a device surface mounted on 25mm x 25mm x 1.6mm FR4 PCB with high coverage of single sided 1oz copper, in still air conditions with the heat-sink split into two equal areas (one for each drain connection); the device is measured when operating in a steady-state condition with one active die.
- Same as note (a), except the device is measured at $t \leq 10$ sec.
- Same as note (a), except the device is pulsed with $D=0.02$ and pulse width 300 μs . The pulse current is limited by the maximum junction temperature.
- For a device surface mounted on 50mm x 50mm x 1.6mm FR4 PCB with high coverage of single sided 2oz copper, in still air conditions with the heat-sink split into two equal areas (one for each drain connection); the device is measured when operating in a steady-state condition with one active die.
- For a device surface mounted on minimum copper 1.6mm FR4 PCB, in still air conditions; the device is measured when operating in a steady-state condition with one active die.
- Thermal resistance from junction to solder-point (at the end of the drain lead); the device is operating in a steady-state condition with one active die.

Thermal characteristics

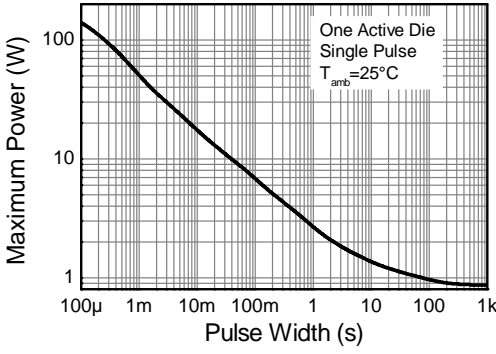
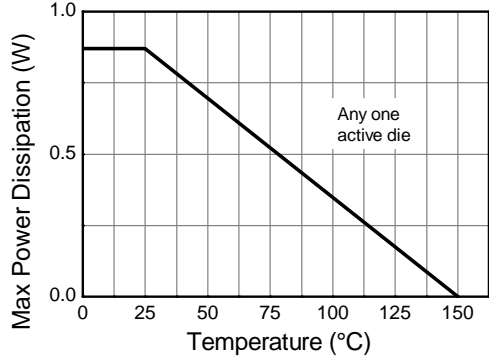
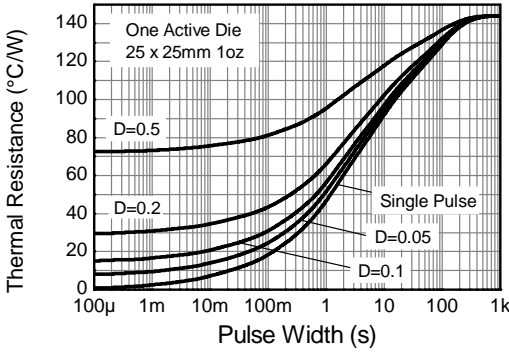
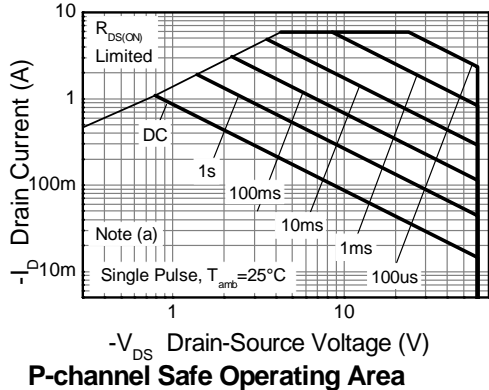
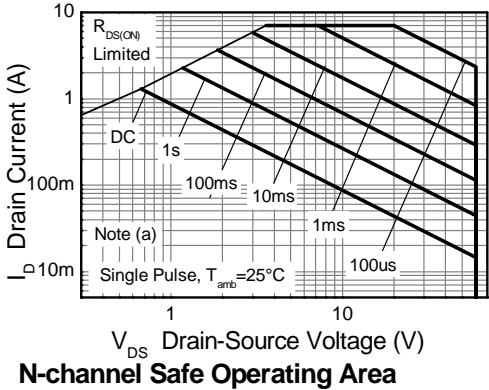

N-channel electrical characteristics (at $T_{amb} = 25^{\circ}\text{C}$ unless otherwise stated)

| Parameter | Symbol | Min. | Typ. | Max. | Unit | Conditions |
|--|---------------|------|------|--------------|---------------|---|
| Static | | | | | | |
| Drain-Source breakdown voltage | $V_{(BR)DSS}$ | 60 | | | V | $I_D = 250\mu\text{A}$, $V_{GS} = 0\text{V}$ |
| Zero Gate voltage Drain current | I_{DSS} | | | 0.5 | μA | $V_{DS} = 60\text{V}$, $V_{GS} = 0\text{V}$ |
| Gate-Body leakage | I_{GSS} | | | ± 100 | nA | $V_{GS} = \pm 20\text{V}$, $V_{DS} = 0\text{V}$ |
| Gate-Source threshold voltage | $V_{GS(th)}$ | 1.0 | | 3.0 | V | $I_D = 250\mu\text{A}$, $V_{DS} = V_{GS}$ |
| Static Drain-Source on-state resistance ^(a) | $R_{DS(on)}$ | | | 0.25 0.35 | Ω | $V_{GS} = 10\text{V}$, $I_D = 1.8\text{A}$ $V_{GS} = 4.5\text{V}$, $I_D = 1.3\text{A}$ |
| Forward Transconductance ^{(a) (c)} | g_{fs} | | 2.3 | | S | $V_{DS} = 15\text{V}$, $I_D = 1.8\text{A}$ |
| Dynamic | | | | | | |
| Capacitance ^(c) | | | | | | |
| Input capacitance | C_{iss} | | 166 | | pF | $V_{DS} = 40\text{V}$, $V_{GS} = 0\text{V}$ $f = 1\text{MHz}$ |
| Output capacitance | C_{oss} | | 19.5 | | pF | |
| Reverse transfer capacitance | C_{rss} | | 8.7 | | pF | |
| Switching ^{(b) (c)} | | | | | | |
| Turn-on-delay time | $t_{d(on)}$ | | 1.8 | | ns | $V_{DD} = 30\text{V}$, $V_{GS} = 10\text{V}$ $I_D = 1.8\text{A}$ $R_G \cong 6.0\Omega$, |
| Rise time | t_r | | 1.4 | | ns | |
| Turn-off delay time | $t_{d(off)}$ | | 4.9 | | ns | |
| Fall time | t_f | | 2.0 | | ns | |
| Gate charge ^(c) | | | | | | |
| Total Gate charge | Q_g | | 3.2 | | nC | $V_{DS} = 30\text{V}$, $V_{GS} = 10\text{V}$ $I_D = 1.8\text{A}$ |
| Gate-Source charge | Q_{gs} | | 0.67 | | nC | |
| Gate-Drain charge | Q_{gd} | | 0.82 | | nC | |
| Source-Drain diode | | | | | | |
| Diode forward voltage ^(a) | V_{SD} | | 0.80 | 0.95 | V | $I_S = 0.45\text{A}$, $V_{GS} = 0\text{V}$ |
| Reverse recovery time ^(c) | t_{rr} | | 20.5 | | ns | $I_S = 1.8\text{A}$, $di/dt = 100\text{A}/\mu\text{s}$ |
| Reverse recovery charge ^(c) | Q_{rr} | | 21.3 | | nC | |

NOTES:

- (a) Measured under pulsed conditions. Pulse width $\leq 300\mu\text{s}$; duty cycle $\leq 2\%$.
 (b) Switching characteristics are independent of operating junction temperature.
 (c) For design aid only, not subject to production testing

N-channel typical characteristics

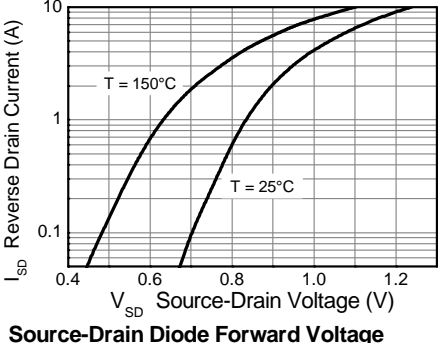
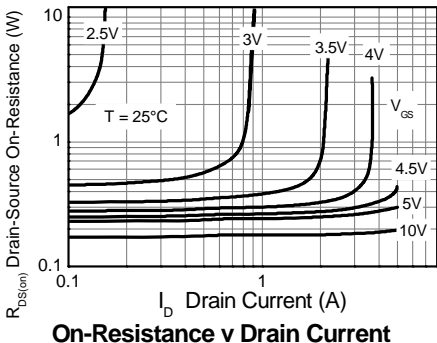
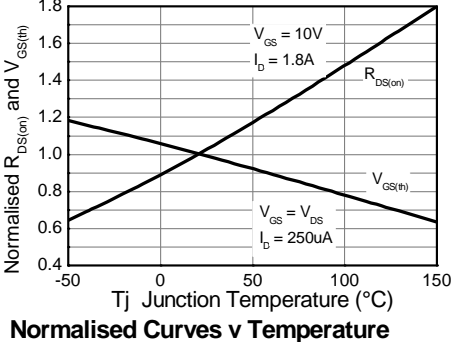
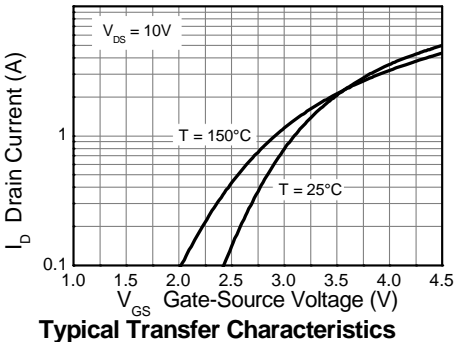
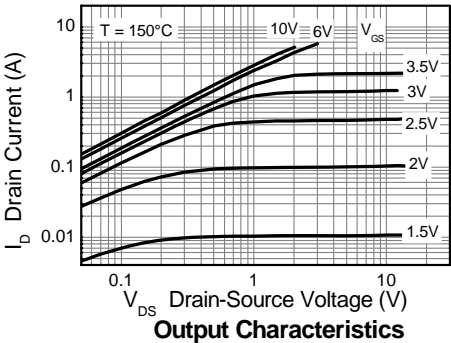
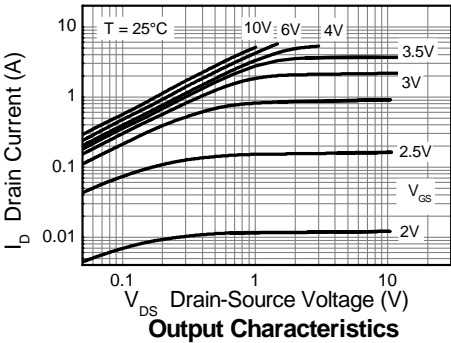

N-channel typical characteristics –continued

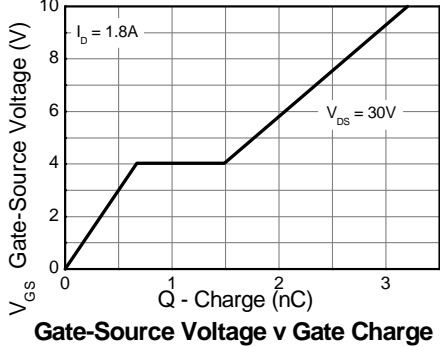
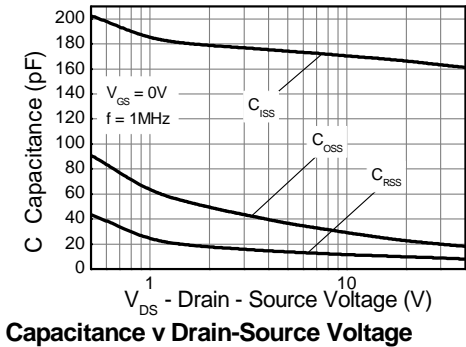

Test circuits

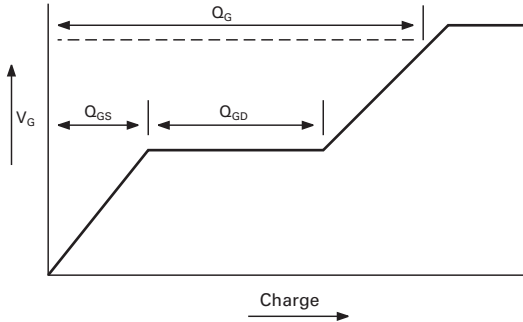

Basic gate charge waveform

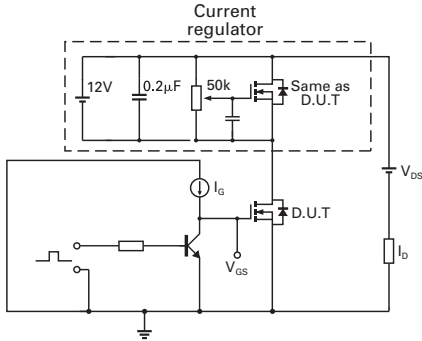

Gate charge test circuit

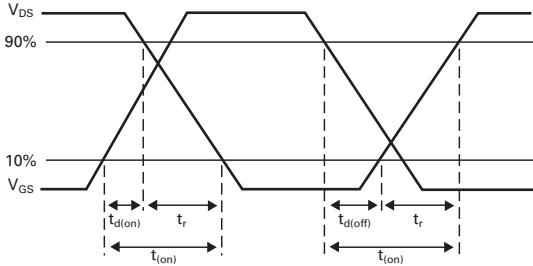

Switching time waveforms

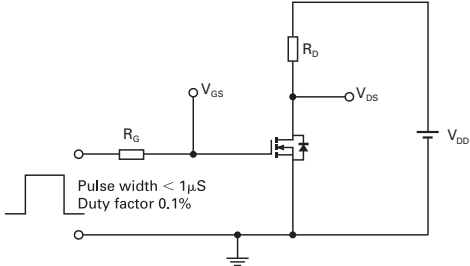

Switching time test circuit

P-channel electrical characteristics (at $T_{amb} = 25^{\circ}\text{C}$ unless otherwise stated)

| Parameter | Symbol | Min. | Typ. | Max. | Unit | Conditions |
|--|---------------|------|-------|--------------|---------------|--|
| Static | | | | | | |
| Drain-Source breakdown voltage | $V_{(BR)DSS}$ | -60 | | | V | $I_D = -250\mu\text{A}$, $V_{GS} = 0\text{V}$ |
| Zero Gate voltage Drain current | I_{DSS} | | | -0.5 | μA | $V_{DS} = -60\text{V}$, $V_{GS} = 0\text{V}$ |
| Gate-Body leakage | I_{GSS} | | | ± 100 | nA | $V_{GS} = \pm 20\text{V}$, $V_{DS} = 0\text{V}$ |
| Gate-Source threshold voltage | $V_{GS(th)}$ | -1.0 | | -3.0 | V | $I_D = -250\mu\text{A}$, $V_{DS} = V_{GS}$ |
| Static Drain-Source on-state resistance ^(a) | $R_{DS(on)}$ | | | 0.40 0.60 | Ω | $V_{GS} = -10\text{V}$, $I_D = -0.9\text{A}$ $V_{GS} = -4.5\text{V}$, $I_D = -0.8\text{A}$ |
| Forward Transconductance ^{(a) (c)} | g_{fs} | | 1.8 | | S | $V_{DS} = -15\text{V}$, $I_D = -0.9\text{A}$ |
| Dynamic | | | | | | |
| Capacitance ^(c) | | | | | | |
| Input capacitance | C_{iss} | | 141 | | pF | $V_{DS} = -50\text{V}$, $V_{GS} = 0\text{V}$ $f = 1\text{MHz}$ |
| Output capacitance | C_{oss} | | 13.1 | | pF | |
| Reverse transfer capacitance | C_{rss} | | 10.8 | | pF | |
| Switching ^{(b) (c)} | | | | | | |
| Turn-on-delay time | $t_{d(on)}$ | | 1.6 | | ns | $V_{DD} = -30\text{V}$, $V_{GS} = -10\text{V}$ $I_D = -1.0\text{A}$ $R_G \cong 6.0\Omega$ |
| Rise time | t_r | | 2.3 | | ns | |
| Turn-off delay time | $t_{d(off)}$ | | 13 | | ns | |
| Fall time | t_f | | 5.8 | | ns | |
| Gate charge ^(c) | | | | | | |
| Total Gate charge | Q_g | | 5.1 | | nC | $V_{DS} = -30\text{V}$, $V_{GS} = -10\text{V}$ $I_D = -0.9\text{A}$ |
| Gate-Source charge | Q_{gs} | | 0.7 | | nC | |
| Gate-Drain charge | Q_{gd} | | 0.7 | | nC | |
| Source-Drain diode | | | | | | |
| Diode forward voltage ^(a) | V_{SD} | | -0.85 | -0.95 | V | $I_S = -0.8\text{A}$, $V_{GS} = 0\text{V}$ |
| Reverse recovery time ^(c) | t_{rr} | | 22.6 | | ns | $I_S = -0.9\text{A}$, $di/dt = 100\text{A}/\mu\text{s}$ |
| Reverse recovery charge ^(c) | Q_{rr} | | 23.2 | | nC | |

NOTES:

- (a) Measured under pulsed conditions. Pulse width $\leq 300\mu\text{s}$; duty cycle $\leq 2\%$.
 (b) Switching characteristics are independent of operating junction temperature.
 (c) For design aid only, not subject to production testing

P-channel typical characteristics

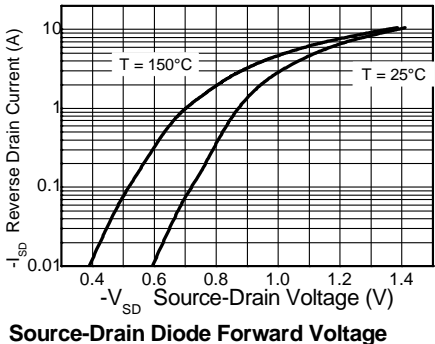
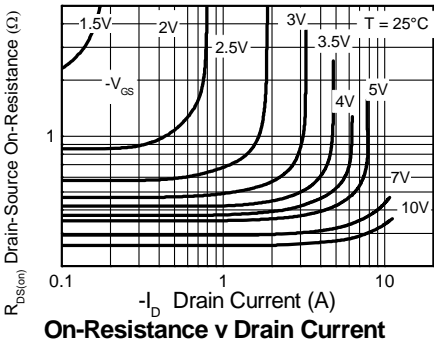
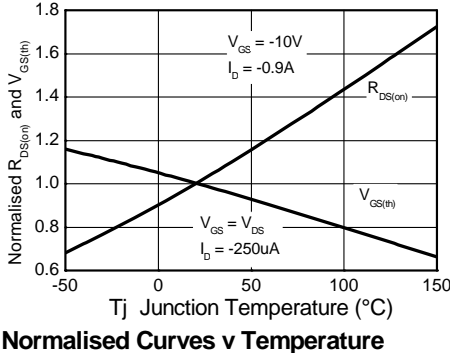
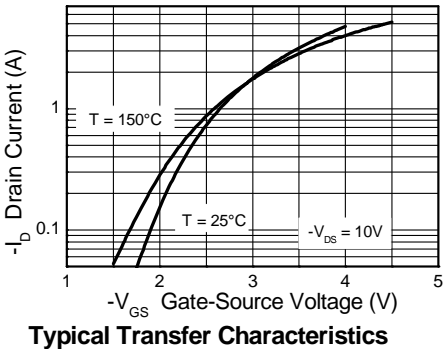
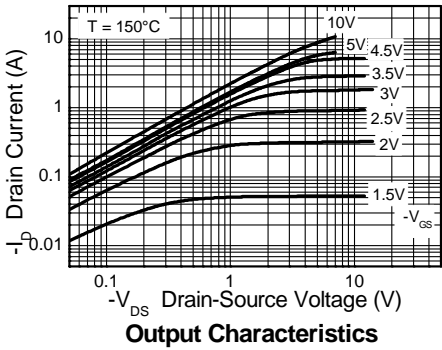
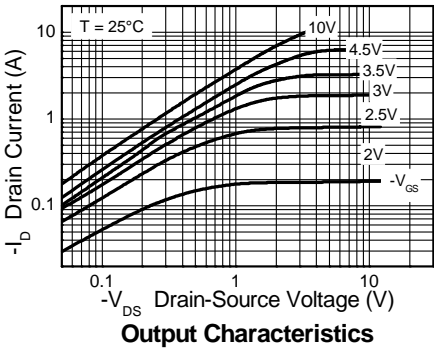

P-channel typical characteristics –continued

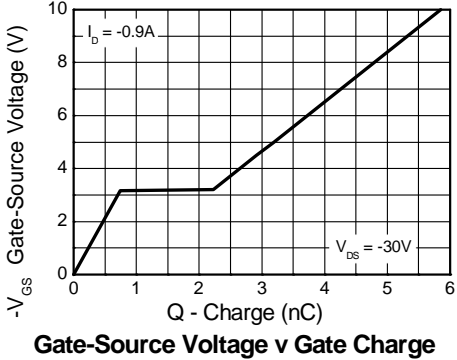
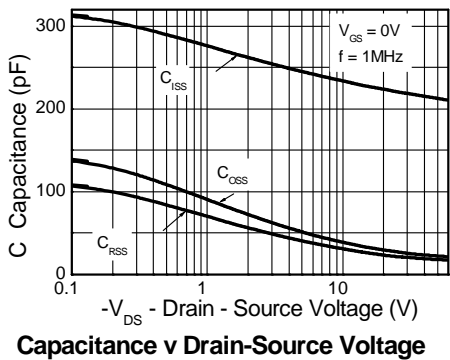

Test circuits

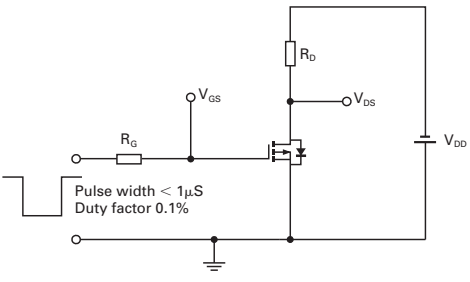
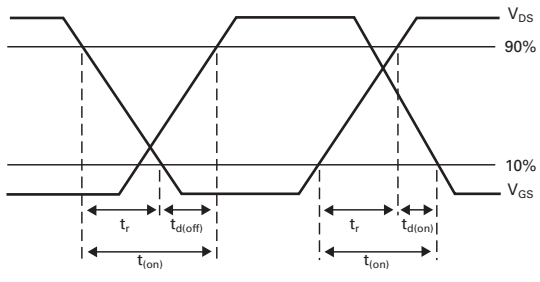
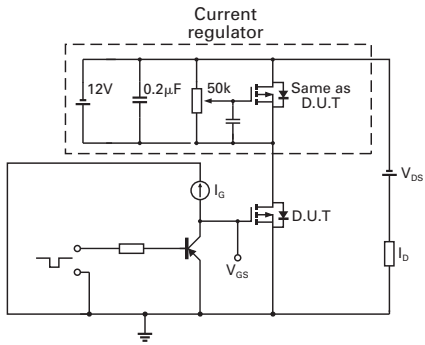
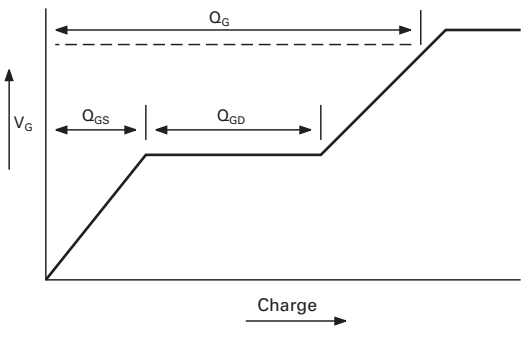

Packaging details - SO8

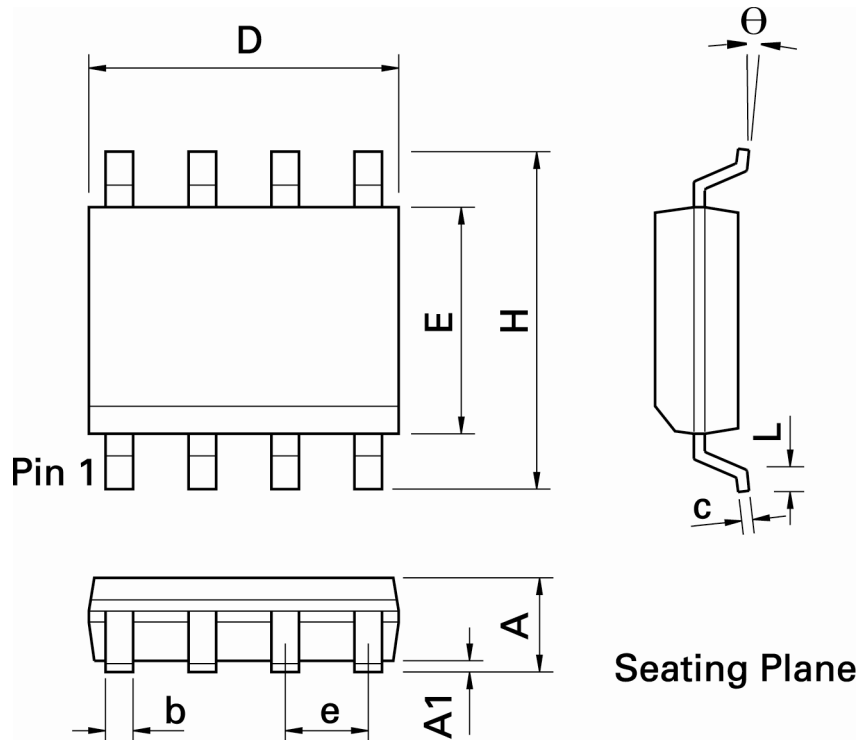

| DIM | Inches | | Millimeters | | DIM | Inches | | Millimeters | |
|-----|--------|-------|-------------|------|-----|-----------|-------|-------------|------|
| | Min. | Max. | Min. | Max. | | Min. | Max. | Min. | Max. |
| A | 0.053 | 0.069 | 1.35 | 1.75 | e | 0.050 BSC | | 1.27 BSC | |
| A1 | 0.004 | 0.010 | 0.10 | 0.25 | b | 0.013 | 0.020 | 0.33 | 0.51 |
| D | 0.189 | 0.197 | 4.80 | 5.00 | c | 0.008 | 0.010 | 0.19 | 0.25 |
| H | 0.228 | 0.244 | 5.80 | 6.20 | θ | 0° | 8° | 0° | 8° |
| E | 0.150 | 0.157 | 3.80 | 4.00 | - | - | - | - | - |
| L | 0.016 | 0.050 | 0.40 | 1.27 | - | - | - | - | - |

Note: Controlling dimensions are in inches. Approximate dimensions are provided in millimeters

IMPORTANT NOTICE

DIODES INCORPORATED MAKES NO WARRANTY OF ANY KIND, EXPRESS OR IMPLIED, WITH REGARDS TO THIS DOCUMENT, INCLUDING, BUT NOT LIMITED TO, THE IMPLIED WARRANTIES OF MERCHANTABILITY AND FITNESS FOR A PARTICULAR PURPOSE (AND THEIR EQUIVALENTS UNDER THE LAWS OF ANY JURISDICTION).

Diodes Incorporated and its subsidiaries reserve the right to make modifications, enhancements, improvements, corrections or other changes without further notice to this document and any product described herein. Diodes Incorporated does not assume any liability arising out of the application or use of this document or any product described herein; neither does Diodes Incorporated convey any license under its patent or trademark rights, nor the rights of others. Any Customer or user of this document or products described herein in such applications shall assume all risks of such use and will agree to hold Diodes Incorporated and all the companies whose products are represented on Diodes Incorporated website, harmless against all damages.

Diodes Incorporated does not warrant or accept any liability whatsoever in respect of any products purchased through unauthorized sales channel.

Should Customers purchase or use Diodes Incorporated products for any unintended or unauthorized application, Customers shall indemnify and hold Diodes Incorporated and its representatives harmless against all claims, damages, expenses, and attorney fees arising out of, directly or indirectly, any claim of personal injury or death associated with such unintended or unauthorized application.

Products described herein may be covered by one or more United States, international or foreign patents pending. Product names and markings noted herein may also be covered by one or more United States, international or foreign trademarks.

LIFE SUPPORT

Diodes Incorporated products are specifically not authorized for use as critical components in life support devices or systems without the express written approval of the Chief Executive Officer of Diodes Incorporated. As used herein:

A. Life support devices or systems are devices or systems which:

1. are intended to implant into the body, or
2. support or sustain life and whose failure to perform when properly used in accordance with instructions for use provided in the labeling can be reasonably expected to result in significant injury to the user.

B. A critical component is any component in a life support device or system whose failure to perform can be reasonably expected to cause the failure of the life support device or to affect its safety or effectiveness.

Customers represent that they have all necessary expertise in the safety and regulatory ramifications of their life support devices or systems, and acknowledge and agree that they are solely responsible for all legal, regulatory and safety-related requirements concerning their products and any use of Diodes Incorporated products in such safety-critical, life support devices or systems, notwithstanding any devices- or systems-related information or support that may be provided by Diodes Incorporated. Further, Customers must fully indemnify Diodes Incorporated and its representatives against any damages arising out of the use of Diodes Incorporated products in such safety-critical, life support devices or systems.

Copyright © 2009, Diodes Incorporated

www.diodes.com

Данный компонент на территории Российской Федерации

Вы можете приобрести в компании MosChip.

Для оперативного оформления запроса Вам необходимо перейти по данной ссылке:

<http://moschip.ru/get-element>

Вы можете разместить у нас заказ для любого Вашего проекта, будь то серийное производство или разработка единичного прибора.

В нашем ассортименте представлены ведущие мировые производители активных и пассивных электронных компонентов.

Нашей специализацией является поставка электронной компонентной базы двойного назначения, продукции таких производителей как XILINX, Intel (ex.ALTERA), Vicor, Microchip, Texas Instruments, Analog Devices, Mini-Circuits, Amphenol, Glenair.

Сотрудничество с глобальными дистрибьюторами электронных компонентов, предоставляет возможность заказывать и получать с международных складов практически любой перечень компонентов в оптимальные для Вас сроки.

На всех этапах разработки и производства наши партнеры могут получить квалифицированную поддержку опытных инженеров.

Система менеджмента качества компании отвечает требованиям в соответствии с ГОСТ Р ИСО 9001, ГОСТ РВ 0015-002 и ЭС РД 009

Офис по работе с юридическими лицами:

105318, г.Москва, ул.Щербаковская д.3, офис 1107, 1118, ДЦ «Щербаковский»

Телефон: +7 495 668-12-70 (многоканальный)

Факс: +7 495 668-12-70 (доб.304)

E-mail: info@moschip.ru

Skype отдела продаж:

moschip.ru

moschip.ru_4

moschip.ru_6

moschip.ru_9