

# SURFACE MOUNT LED WHITE, 5730 PACKAGE, 0.5W

# BIVAR

## SM5730UWDX05

- ◆ Industry Standard 5730 Package
- ◆ RoHS Compliant
- ◆ Small Package and Footprint
- ◆ X - (C) Cool White, (N) Neutral White, (W) Warm White
- ◆ Wide Viewing Angle
- ◆ Ideal for Lighting and Backlighting Application



Bivar Surface Mount 5730 package LED may be used in nearly any lighting or backlighting application. These 0.5 Watt SMD LED's have a minimum CRI Value of 80 and are available in 3 color temperatures to meet any illumination needs: Cool, Neutral and Warm White. The SM5730 Series is conveniently packaged in standard tape and reels for pick and place assemblies.

Part Number	Material	Emitted Color	Lens Color	Luminous Flux (lm) TYP.	Viewing Angle
SM5730UWDC05	InGaN	Cool White	Diffused	57	120°
SM5730UWDN05	InGaN	Neutral White	Diffused	57	120°
SM5730UWDW05	InGaN	Warm White	Diffused	53	120°

## Outline Dimensions

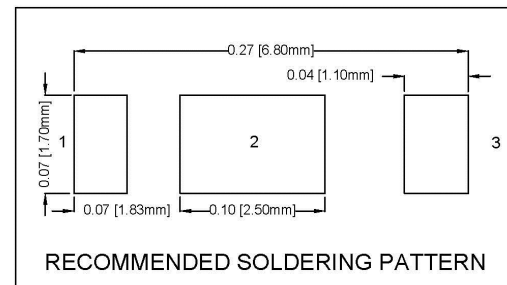
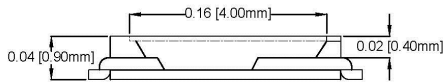
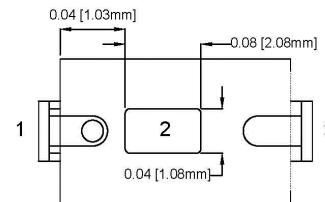
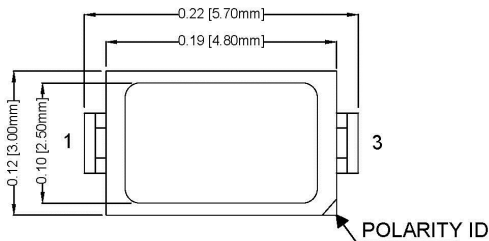

### Outline Drawings Notes:

1. All dimensions are in inches [millimeters].
2. Standard tolerance:  $\pm 0.010''$  unless otherwise noted.



Bivar reserves the right to make changes at any time without notice.

# SURFACE MOUNT LED WHITE, 5730 PACKAGE, 0.5W



## Absolute Maximum Ratings

$T_A = 25^\circ\text{C}$  unless otherwise noted

Power Dissipation	0.63 W
Forward Current ( DC )	180 mA
Peak Forward Current <sup>1</sup>	260 mA
Reverse Voltage	5 V
Electrostatic Discharge (HBM)	2000 V
Operating Temperature Range	-40 ~ +100°C
Storage Temperature Range	-40 ~ +100°C
Junction Temperature	115°C
Lead Soldering Temperature <sup>2</sup>	260°C

- Notes: 1.  $\leq 10\%$  Duty Cycle, Pulse Width  $\leq 0.1$  msec.  
2. Solder time less than 5 seconds at temperature extreme.

## Electrical / Optical Characteristics

$T_A = 25^\circ\text{C}$  &  $I_F = 150$  mA unless otherwise noted

Part Number	Forward Voltage (V)			Recommend Forward Current (mA)	Reverse Current ( $\mu\text{A}$ ) $V_R=5\text{V}$	CCT (Kelvin)			Luminous Flux (lm)			Viewing Angle $2\theta_{1/2}$ (deg)
	MIN	TYP	MAX	TYP	MAX	MIN	TYP	MAX	MIN	TYP	MAX	TYP
SM5730UWDC05	2.8	/	3.5	150	10	5300	6000	6480	50	57	67	120
SM5730UWDN05	2.8	/	3.5	150	10	3700	4000	4500	50	57	65	120
SM5730UWDW05	2.8	/	3.5	150	10	2700	3000	3250	45	53	60	120

- Notes: 1. The above forward voltage measurement allowance tolerance is  $\pm 0.1\text{V}$ .  
2. The above luminous flux measurement allowance tolerance  $\pm 10\%$ .

Bivar reserves the right to make changes at any time without notice.

# SURFACE MOUNT LED WHITE, 5730 PACKAGE, 0.5W



## Typical Electrical / Optical Characteristics

$T_A = 25^\circ\text{C}$  unless otherwise noted

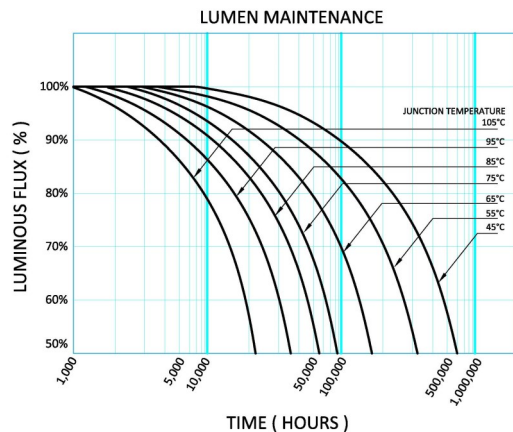
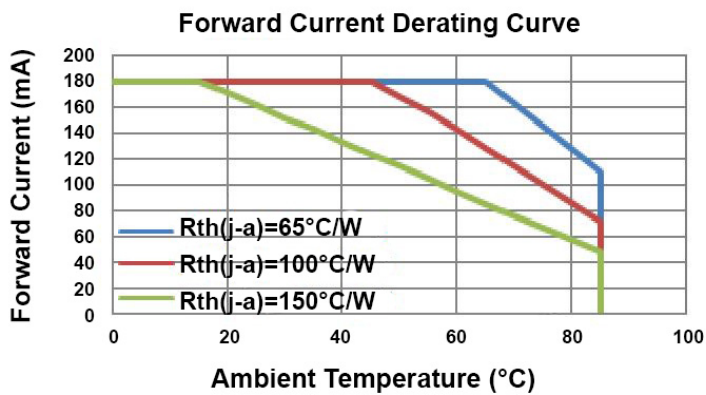
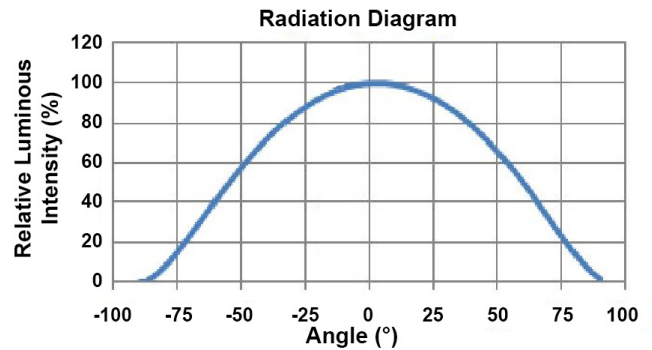
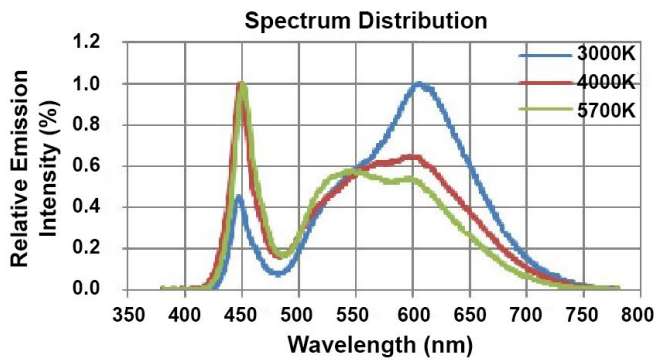
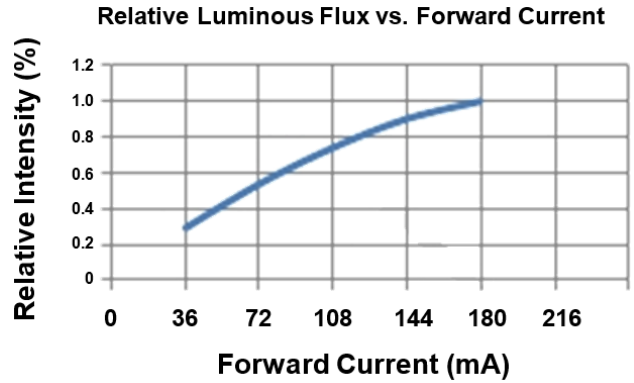
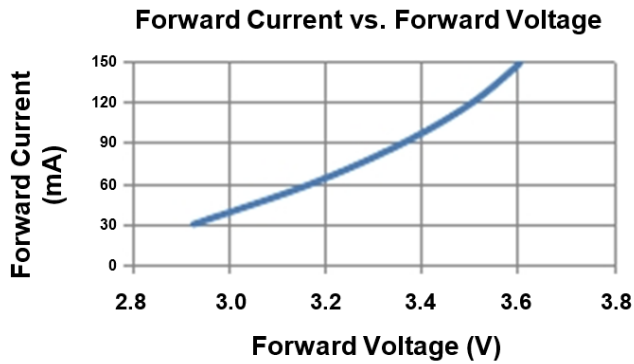

Bivar reserves the right to make changes at any time without notice.

# SURFACE MOUNT LED WHITE, 5730 PACKAGE, 0.5W



## Recommended Soldering Conditions

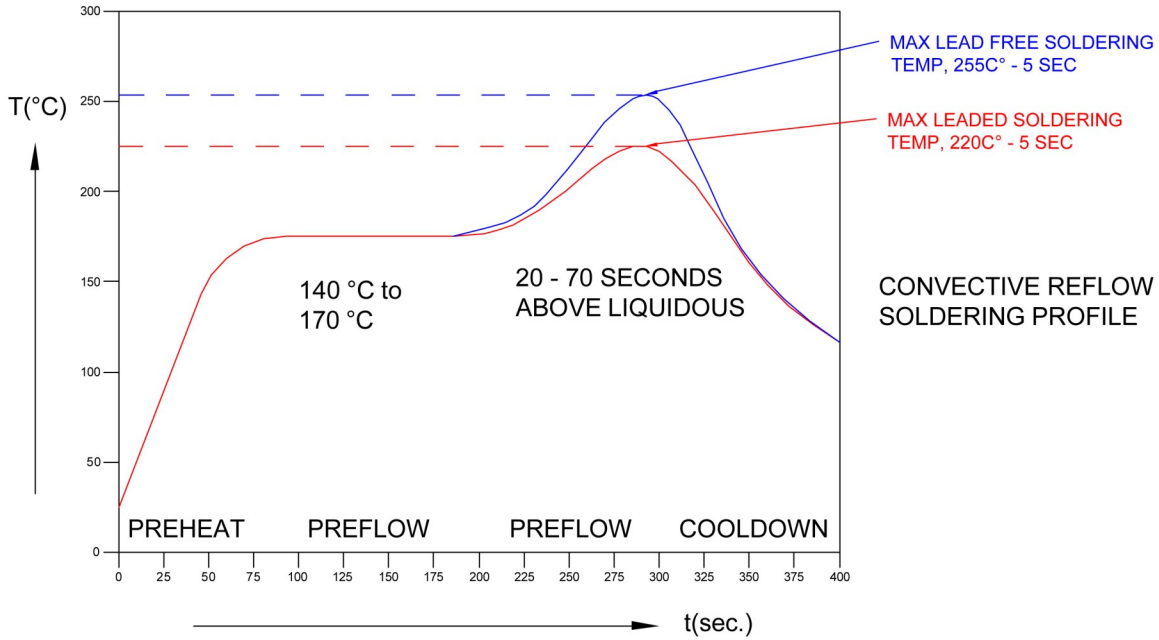

## Tape and Reel Dimensions

Note: 3000 pcs/Reel

### • Dimensions of Tape

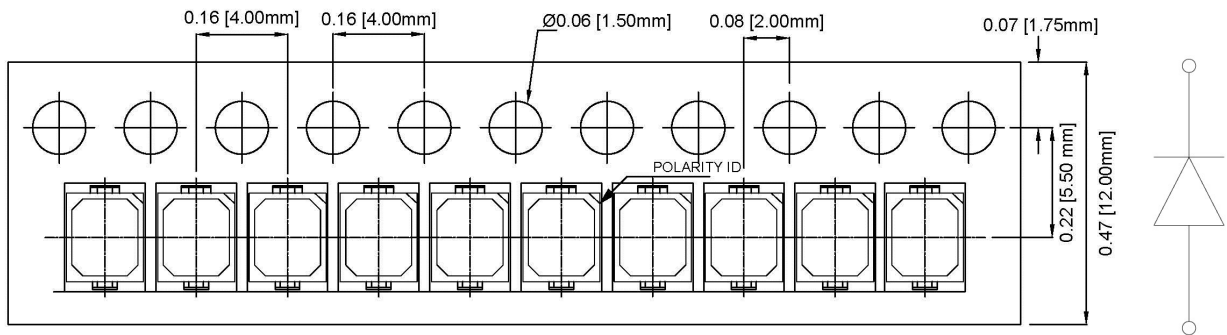

### • Arrangement of Tape

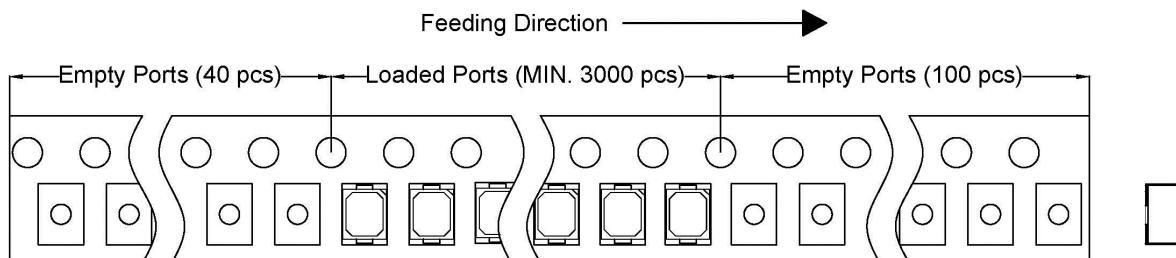

### Outline Drawings Notes:

1. All dimensions are in inches [millimeters].
2. Standard tolerance:  $\pm 0.010$ " unless otherwise noted.

Bivar reserves the right to make changes at any time without notice.

# SURFACE MOUNT LED WHITE, 5730 PACKAGE, 0.5W

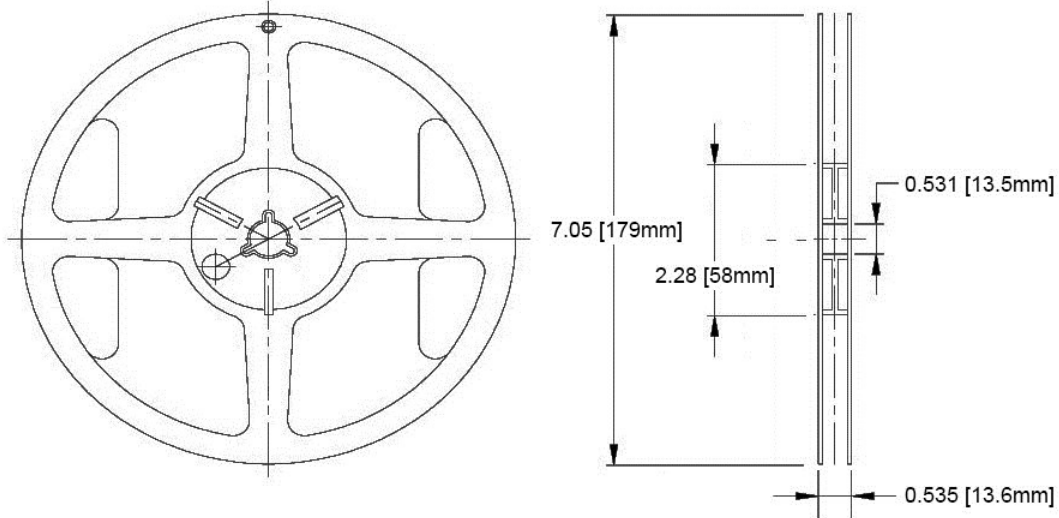

**Outline Drawings Notes:**

1. All dimensions are in inches [millimeters].
2. Standard tolerance unless otherwise noted: X.XXX ± 0.010"  
X.X ± 0.1"

## Packaging and Labeling Plan

Note: 1 Reel / Bag

Vacuum and Heat Sealed  
ESD/MBB Bag

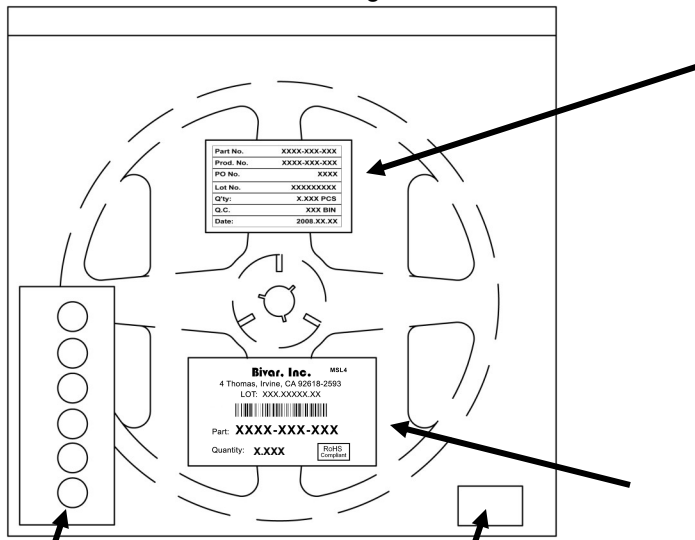

Humidity Indicator Card

Desiccants

Part No.	XXXX-XXX-XXX
Prod. No.	XXXX-XXX-XXX
PO No.	XXXX
Lot No.	XXXXXXXXXX
Q'ty:	X.XXX PCS
Q.C.	XXX BIN
Date:	2008.XX.XX

Internal Quality Control

**Bivar, Inc.** MSL4

4 Thomas, Irvine, CA 92618-2593  
LOT: XXX.XXXXX.XX



Part: **XXXX-XXX-XXX**

Quantity: **X.XXX**

RoHS  
Compliant

Bivar Standard Packaging Label

Bivar reserves the right to make changes at any time without notice.

## Данный компонент на территории Российской Федерации

### Вы можете приобрести в компании MosChip.

Для оперативного оформления запроса Вам необходимо перейти по данной ссылке:

<http://moschip.ru/get-element>

Вы можете разместить у нас заказ для любого Вашего проекта, будь то серийное производство или разработка единичного прибора.

В нашем ассортименте представлены ведущие мировые производители активных и пассивных электронных компонентов.

Нашей специализацией является поставка электронной компонентной базы двойного назначения, продукции таких производителей как XILINX, Intel (ex.ALTERA), Vicor, Microchip, Texas Instruments, Analog Devices, Mini-Circuits, Amphenol, Glenair.

Сотрудничество с глобальными дистрибьюторами электронных компонентов, предоставляет возможность заказывать и получать с международных складов практически любой перечень компонентов в оптимальные для Вас сроки.

На всех этапах разработки и производства наши партнеры могут получить квалифицированную поддержку опытных инженеров.

Система менеджмента качества компании отвечает требованиям в соответствии с ГОСТ Р ИСО 9001, ГОСТ РВ 0015-002 и ЭС РД 009

### Офис по работе с юридическими лицами:

105318, г.Москва, ул.Щербаковская д.3, офис 1107, 1118, ДЦ «Щербаковский»

Телефон: +7 495 668-12-70 (многоканальный)

Факс: +7 495 668-12-70 (доб.304)

E-mail: [info@moschip.ru](mailto:info@moschip.ru)

Skype отдела продаж:

moschip.ru

moschip.ru\_4

moschip.ru\_6

moschip.ru\_9