



Fully Accurate 14-/16-Bit V_{OUT} *nanoDAC*[™] SPI Interface 2.7 V to 5.5 V, in an SOT-23

AD5040/AD5060

FEATURES

- Single 14-/16-bit DAC, 1 LSB INL
- Power-on reset to midscale or zero scale
- Guaranteed monotonic by design
- 3 power-down functions
- Low power serial interface with Schmitt-triggered inputs
- Small 8-lead SOT-23 package, low power
- Fast settling time of 4 μ s typically
- 2.7 V to 5.5 V power supply
- Low glitch on power-up
- SYNC interrupt facility

APPLICATIONS

- Process control
- Data acquisition systems
- Portable battery-powered instruments
- Digital gain and offset adjustment
- Programmable voltage and current sources
- Programmable attenuators

GENERAL DESCRIPTION

The AD5040 and the AD5060, members of the ADI *nanoDAC* family, are low power, single 14-/16-bit buffered voltage-out DACs that operate from a single 2.7 V to 5.5 V supply. The AD5040/AD5060 parts offer a relative accuracy specification of ± 1 LSB and operation are guaranteed monotonic with a ± 1 LSB DNL specification. The parts use a versatile 3-wire serial interface that operates at clock rates up to 30 MHz and is compatible with standard SPI[®], QSPI[™], MICROWIRE[™], and DSP interface standards. The reference for both the AD5040 and AD5060 is supplied from an external V_{REF} pin. A reference buffer is also provided on-chip. The AD5060 incorporates a power-on reset circuit that ensures the DAC output powers up to midscale or zero scale and remains there until a valid write takes place to the device. The AD5040 and the AD5060 both contain a power-down feature that reduces the current consumption of the device to typically 330 nA at 5 V and provides software-selectable output loads while in power-down mode. The parts are put into power-down mode over the serial interface. Total unadjusted error for the parts is < 2 mV. Both parts exhibit very low glitch on power-up.

FUNCTIONAL BLOCK DIAGRAM



Figure 1.

PRODUCT HIGHLIGHTS

1. Available in a small, 8-lead SOT-23 package.
2. 14-/16-bit accurate, 1 LSB INL.
3. Low glitch on power-up.
4. High speed serial interface with clock speeds up to 30 MHz.
5. Three power-down modes available to the user.
6. Reset to known output voltage (midscale, zero scale).

Table 1. Related Devices

| Part No. | Description |
|----------|--|
| AD5061 | 2.7 V to 5.5 V, 16-bit <i>nanoDAC</i> D/A, 4 LSB INL, SOT-23 |
| AD5062 | 2.7 V to 5.5 V, 16-bit <i>nanoDAC</i> D/A, 1 LSB INL, SOT-23 |
| AD5063 | 2.7 V to 5.5 V, 16-bit <i>nanoDAC</i> D/A, 1 LSB INL, MSOP |

Rev. A

Information furnished by Analog Devices is believed to be accurate and reliable. However, no responsibility is assumed by Analog Devices for its use, nor for any infringements of patents or other rights of third parties that may result from its use. Specifications subject to change without notice. No license is granted by implication or otherwise under any patent or patent rights of Analog Devices. Trademarks and registered trademarks are the property of their respective owners.

One Technology Way, P.O. Box 9106, Norwood, MA 02062-9106, U.S.A.
Tel: 781.329.4700 www.analog.com
Fax: 781.461.3113 © 2005-2010 Analog Devices, Inc. All rights reserved.

TABLE OF CONTENTS

| | | | |
|--|----|--|----|
| Features | 1 | Reference Buffer | 15 |
| Applications..... | 1 | Serial Interface..... | 15 |
| General Description..... | 1 | Power-On reset..... | 16 |
| Functional Block Diagram | 1 | Software Reset..... | 16 |
| Product Highlights | 1 | Power-Down Modes | 17 |
| Revision History | 2 | Microprocessor Interfacing..... | 17 |
| Specifications..... | 3 | Applications..... | 19 |
| Timing Characteristics..... | 5 | Choosing a Reference for the AD5040/ AD5060..... | 19 |
| Absolute Maximum Ratings..... | 6 | Bipolar Operation Using the AD5040/ AD5060..... | 19 |
| ESD Caution..... | 6 | Using the AD5040/AD5060 with a Galvanically Isolated Interface Chip | 20 |
| Pin Configuration and Function Descriptions..... | 7 | Power Supply Bypassing and Grounding..... | 20 |
| Typical Performance Characteristics | 8 | Outline Dimensions | 21 |
| Terminology | 14 | Ordering Guide | 21 |
| Theory of Operation | 15 | | |
| DAC Architecture..... | 15 | | |

REVISION HISTORY

1/10—Rev. 0 to Rev. A

| | |
|--|----|
| Changes to Table 2, Relative Accuracy (INL) and Endnote 1 | 3 |
| Updated Outline Dimensions | 21 |
| Changes to Ordering Guide | 21 |

10/05—Revision 0: Initial Version

SPECIFICATIONS

$V_{DD} = 5.5\text{ V}$, $V_{REF} = 4.096\text{ V}$ @ $R_L = \text{unloaded}$, $C_L = \text{unloaded}$; T_{MIN} to T_{MAX} , unless otherwise noted.

Table 2.

| Parameter | A, B, and Y Grades ¹ | | | Unit | Test Conditions/Comments |
|---|---------------------------------|--------|-----------|---------------|---|
| | Min | Typ | Max | | |
| STATIC PERFORMANCE | | | | | |
| Resolution | 16 | | | Bits | AD5060 |
| | 14 | | | Bits | AD5040 |
| Relative Accuracy (INL) ² | | ±0.5 | ±2 | LSB | −40°C to +85°C, AD5040/AD5060 A grade |
| | | ±0.5 | ±1 | LSB | −40°C to +85°C, AD5040/AD5060 B grade |
| | | ±0.5 | ±1.5 | | −40°C to +125°C, AD5060 Y grade |
| Total Unadjusted Error (TUE) ² | | ±0.1 | ±2.0 | mV | −40°C to +85°C, AD5040/AD5060 |
| | | ±0.1 | ±2.0 | | −40°C to +125°C, AD5060 Y grade |
| Differential Nonlinearity (DNL) ² | | ±0.5 | ±1 | LSB | Guaranteed monotonic, −40°C to +85°C, AD5040/AD5060 |
| | | ±0.5 | ±1 | | Guaranteed monotonic, −40°C to +125°C, Y grade |
| Gain Error | | ±0.01 | ±0.02 | % of FSR | $T_A = -40^\circ\text{C}$ to $+85^\circ\text{C}$, AD5040/AD5060 |
| | | ±0.01 | ±0.03 | | $T_A = -40^\circ\text{C}$ to $+125^\circ\text{C}$ AD5060 Y grade |
| Gain Error Temperature Coefficient | | 1 | | ppm of FSR/°C | |
| Offset Error | | ±0.02 | ±1.5 | mV | $T_A = -40^\circ\text{C}$ to $+85^\circ\text{C}$, AD5040/AD5060 |
| | | ±0.02 | ±2.0 | | $T_A = -40^\circ\text{C}$ to $+125^\circ\text{C}$, AD5060 Y grade |
| Offset Error Temperature Coefficient | | 0.5 | | μV/°C | |
| Full-Scale Error | | ±0.05 | ±2.0 | mV | All 1s loaded to DAC register, AD5040 AD5060; $T_A = -40^\circ\text{C}$ to $+85^\circ\text{C}$ |
| | | ±0.05 | ±2.0 | | All 1s loaded to DAC register, $T_A = -40^\circ\text{C}$ to $+125^\circ\text{C}$, AD5060 Y grade |
| OUTPUT CHARACTERISTICS ³ | | | | | |
| Output Voltage Range | 0 | | V_{REF} | V | |
| Output Voltage Settling Time | | 4 | | μs | ¼ scale to ¾ scale code transition to ±1 LSB, $R_L = 5\text{ k}\Omega$ |
| Output Noise Spectral Density | | 64 | | nV/√Hz | DAC code = midscale, 1 kHz |
| Output Voltage Noise | | 6 | | μV p-p | DAC code = midscale, 0.1 Hz to 10 Hz bandwidth |
| Digital-to-Analog Glitch Impulse | | 2 | | nV-s | 1 LSB change around code 57386, $R_L = 5\text{ k}\Omega$, $C_L = 200\text{ pF}$ |
| Digital Feedthrough | | 0.003 | | nV-s | DAC code = full scale |
| DC Output Impedance (Normal) | | 0.015 | | Ω | Output impedance tolerance ±10% |
| DC Output Impedance (Power-Down) | | | | | |
| (Output Connected to 1 kΩ Network) ⁴ | | 1 | | kΩ | Output impedance tolerance ±400 Ω |
| (Output Connected to 100 kΩ Network) | | 100 | | kΩ | Output impedance tolerance ±20 kΩ |
| Capacitive Load Stability | | | 1 | nF | Loads used $R_L = 5\text{ k}\Omega$, $R_L = 100\text{ k}\Omega$, $R_L = \infty$ |
| Slew Rate | | 1.2 | | V/μs | ¼ scale to ¾ scale code transition to ±1 LSB, $R_L = 5\text{ k}\Omega$, $C_L = 200\text{ pF}$ |
| Short-Circuit Current | | 60 | | ma | DAC code = full scale, output shorted to GND, $T_A = 25^\circ\text{C}$ |
| | | 45 | | | DAC code = zero scale, output shorted to V_{DD} , $T_A = 25^\circ\text{C}$ |
| DAC Power-Up Time | | 4.5 | | μs | Time to exit power-down mode to normal mode of AD5060, 24 th clock edge to 90% of DAC final value, output unloaded |
| DC Power Supply Rejection Ratio | | −92.11 | | db | $V_{DD} \pm 10\%$, DAC code = full scale |

AD5040/AD5060

| Parameter | A, B, and Y Grades ¹ | | | Unit | Test Conditions/Comments |
|--|---------------------------------|-----------|---------------|------------|--|
| | Min | Typ | Max | | |
| Wideband Spurious-Free Dynamic Range (SFDR) | -67 | | | db | Output frequency = 10 kHz |
| REFERENCE INPUT/OUTPUT | | | | | |
| V_{REF} Input Range ⁵ | 2 | | $V_{DD} - 50$ | mV | Zero scale loaded |
| Input Current (Power-Down) | | ± 0.1 | | μA | |
| Input Current (Normal) | | | ± 0.5 | μA | |
| DC Input Impedance | 1 | | | M Ω | |
| LOGIC INPUTS | | | | | |
| Input Current ⁶ | | ± 1 | ± 2 | μA | $V_{DD} = 4.5 V$ to $5.5 V$ $V_{DD} = 2.7 V$ to $3.6 V$ $V_{DD} = 2.7 V$ to $5.5 V$ $V_{DD} = 2.7 V$ to $3.6 V$ |
| V_{IL} , Input Low Voltage | | | 0.8 | V | |
| V_{IH} , Input High Voltage | 2.0 | | 0.8 | V | |
| Pin Capacitance | 1.8 | 4 | | pF | |
| POWER REQUIREMENTS | | | | | |
| V_{DD} | 2.7 | | 5.5 | V | All digital inputs at 0 V or V_{DD} DAC active and excluding load current |
| I_{DD} (Normal Mode) $V_{DD} = 2.7 V$ to $5.5 V$ | | 1.0 | 1.2 | mA | |
| | | 0.82 | 1.0 | | $V_{IN} = V_{DD}$ and $V_{IL} = GND$, $V_{DD} = 5.0 V$, $V_{REF} = 4.096 V$, code = midscale |
| | | | | | $V_{IN} = V_{DD}$ and $V_{IL} = GND$, $V_{DD} = 3.0 V$, $V_{REF} = 2.7 V$, code = midscale |
| I_{DD} (All Power-Down Modes) $V_{DD} = 2.5 V$ to $5.5 V$ | | 0.33 | 1 | μA | $V_{IH} = V_{DD}$ and $V_{IL} = GND$, $V_{DD} = 5.5 V$, $V_{REF} = 4.096 V$, code = midscale |
| | | 0.065 | | | $V_{IH} = V_{DD}$ and $V_{IL} = GND$, $V_{DD} = 3.0 V$, $V_{REF} = 4.096 V$, code = midscale |

¹ Temperature range for the A and B grades is $-40^{\circ}C$ to $+85^{\circ}C$, typical at $25^{\circ}C$; temperature range for the Y grade is $-40^{\circ}C$ to $+125^{\circ}C$.

² Linearity calculated using a reduced code range (160 to code 65535 for AD5060) and (40 to code 16383 for AD5040).

³ Guaranteed by design and characterization, not production tested.

⁴ 1 k Ω power-down network not available with the AD5040.

⁵ The typical output supply headroom performance for various reference voltages at $-40^{\circ}C$ can be seen in Figure 26.

⁶ Total current flowing into all pins.

TIMING CHARACTERISTICS

$V_{DD} = 2.7\text{ V to }5.5\text{ V}$; all specifications T_{MIN} to T_{MAX} , unless otherwise noted.

Table 3.

| Parameter | Limit ¹ | Unit | Test Conditions/Comments |
|-----------|--------------------|--------|---|
| t_1^2 | 33 | ns min | SCLK cycle time |
| t_2 | 5 | ns min | SCLK high time |
| t_3 | 3 | ns min | SCLK low time |
| t_4 | 10 | ns min | $\overline{\text{SYNC}}$ to SCLK falling edge setup time |
| t_5 | 3 | ns min | Data setup time |
| t_6 | 2 | ns min | Data hold time |
| t_7 | 0 | ns min | SCLK falling edge to $\overline{\text{SYNC}}$ rising edge |
| t_8 | 12 | ns min | Minimum $\overline{\text{SYNC}}$ high time |
| t_9 | 9 | ns min | $\overline{\text{SYNC}}$ rising edge to next SCLK fall ignore |

¹ All input signals are specified with $t_r = t_f = 1\text{ ns/V}$ (10% to 90% of V_{DD}) and timed from a voltage level of $(V_{IL} + V_{IH})/2$.

² Maximum SCLK frequency is 30 MHz.



Figure 2. AD5060 Timing Diagram

04767-002

ABSOLUTE MAXIMUM RATINGS

Table 4.

| Parameter | Rating |
|---|---------------------------------------|
| V _{DD} to GND | −0.3 V to +7.0 V |
| Digital Input Voltage to GND | −0.3 V to V _{DD} + 0.3 V |
| V _{OUT} to GND | −0.3 V to V _{DD} + 0.3 V |
| V _{REF} to GND | −0.3 V to V _{DD} + 0.3 V |
| Operating Temperature Range | |
| Industrial (A, B Grade) | −40°C to +85°C |
| Extended Automotive Temperature Range (Y Grade) | −40°C to +125°C |
| Storage Temperature Range | −65°C to +150°C |
| Maximum Junction Temperature | 150°C |
| SOT-23 Package | |
| Power Dissipation | $(T_J \text{ max} - T_A)/\theta_{JA}$ |
| θ_{JA} Thermal Impedance | 206°C/W |
| θ_{JC} Thermal Impedance | 91°C/W |
| Reflow Soldering (Pb-free) | |
| Peak Temperature | 260°C |
| Time-at-Peak Temperature | 10 sec to 40 sec |
| ESD (AD5040/AD5060) | 1.5 kV |

Stresses above those listed under Absolute Maximum Ratings may cause permanent damage to the device. This is a stress rating only; functional operation of the device at these or any other conditions above those indicated in the operational section of this specification is not implied. Exposure to absolute maximum rating conditions for extended periods may affect device reliability.

This device is a high performance integrated circuit with an ESD rating of <2 kV. It is ESD sensitive. Proper precautions should be taken for handling and assembly.

ESD CAUTION

ESD (electrostatic discharge) sensitive device. Electrostatic charges as high as 4000 V readily accumulate on the human body and test equipment and can discharge without detection. Although this product features proprietary ESD protection circuitry, permanent damage may occur on devices subjected to high energy electrostatic discharges. Therefore, proper ESD precautions are recommended to avoid performance degradation or loss of functionality.



PIN CONFIGURATION AND FUNCTION DESCRIPTIONS



Figure 3. Pin Configuration

Table 5. Pin Function Descriptions

| Pin No. | Mnemonic | Description |
|---------|-------------------|---|
| 1 | DIN | Serial Data Input. These parts have a 16-/24-bit shift register. Data is clocked into the register on the falling edge of the serial clock input. |
| 2 | V_{DD} | Power Supply Input. These parts can be operated from 2.7 V to 5.5 V and V_{DD} should be decoupled to GND. |
| 3 | V_{REF} | Reference Voltage Input. |
| 4 | V_{OUT} | Analog Output Voltage from DAC. |
| 5 | AGND | Ground Reference Point for Analog Circuitry. |
| 6 | DACGND | Ground Input to the DAC Core. |
| 7 | \overline{SYNC} | Level-Triggered Control Input (Active Low). This is the frame synchronization signal for the input data. When \overline{SYNC} goes low, it enables the input shift register and data is transferred in on the falling edges of the following clocks. The DAC is updated following the 16th/24th clock cycle unless \overline{SYNC} is taken high before this edge, in which case the rising edge of \overline{SYNC} acts as an interrupt, and the write sequence is ignored by the DAC. |
| 8 | SCLK | Serial Clock Input. Data is clocked into the input shift register on the falling edge of the serial clock input. Data can be transferred at rates up to 30 MHz. |

TYPICAL PERFORMANCE CHARACTERISTICS



Figure 4. Typical AD5060 INL Plot



Figure 7. Typical AD5040 INL Plot



Figure 5. Typical AD5060 DNL Plot



Figure 8. Typical AD5040 DNL Plot

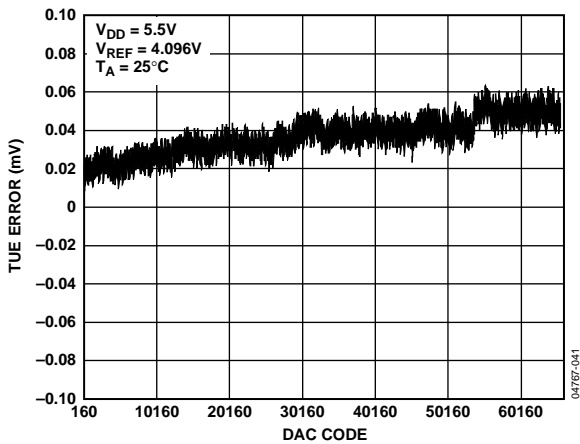

Figure 6. Typical AD5060 TUE Plot



Figure 9. Typical AD5040 TUE Plot



Figure 10. INL vs. Reference Input Voltage¹



Figure 11. DNL vs. Reference Input Voltage¹



Figure 12. TUE vs. Reference Input Voltage¹



Figure 13. Typical Offset Error vs. Temperature¹



Figure 14. Typical Gain Error vs. Temperature¹



Figure 15. Typical INL Error vs. Temperature¹

¹ AD5060 only.

AD5040/AD5060



Figure 16. Typical DNL Error vs. Temperature¹



Figure 17. Typical TUE Error vs. Temperature¹



Figure 18. Typical Supply Current vs. Temperature¹

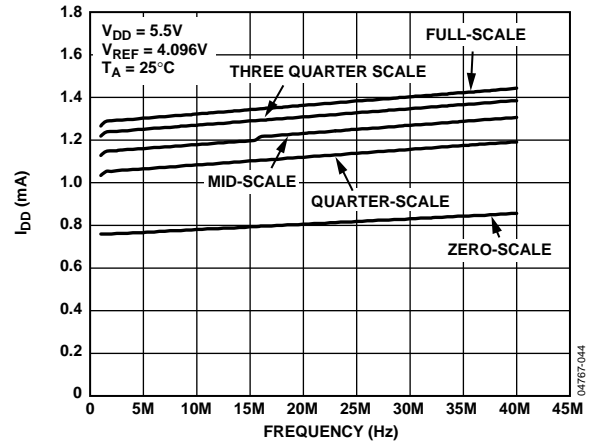

Figure 19. Typical Supply Current vs. Frequency @ 5.5V¹

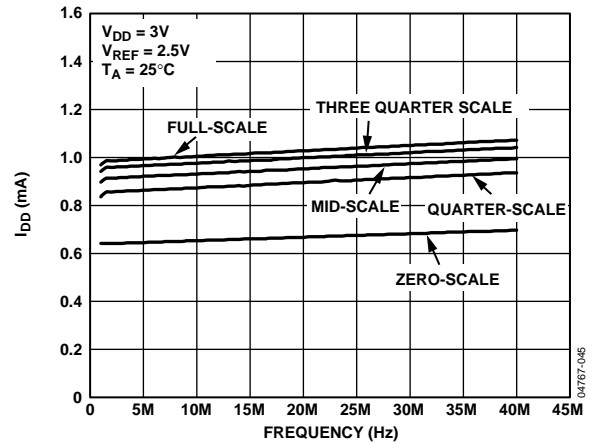

Figure 20. Typical Supply Current vs. Frequency @ 3V¹

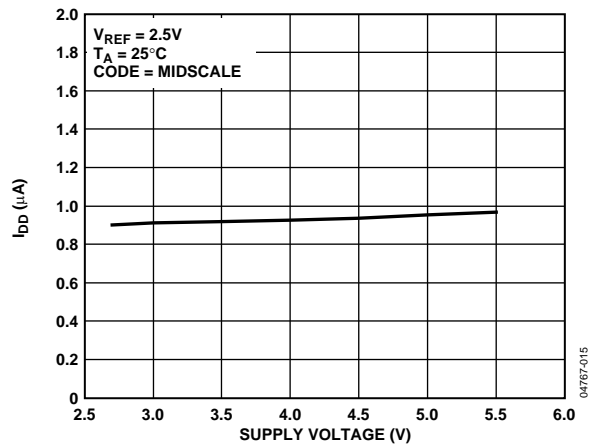

Figure 21. Typical Supply Current vs. Supply Voltage¹

¹ AD5060 only.



Figure 22. Typical Supply Current vs. Digital Input Code¹



Figure 25. 0.1 Hz to 10 Hz Noise Plot

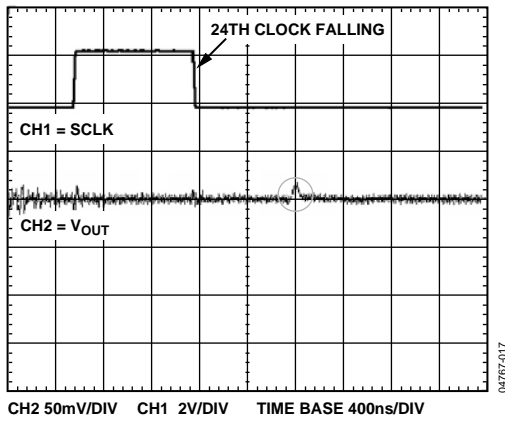

Figure 23. AD5060 Digital-to-Analog Glitch Impulse (See Figure 24)



Figure 26. V_{DD} Headroom vs. Reference Voltage

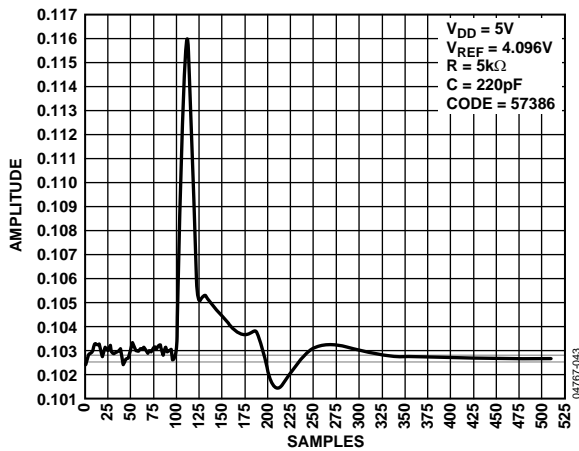

Figure 24. AD5060 Digital-to-Analog Glitch Energy

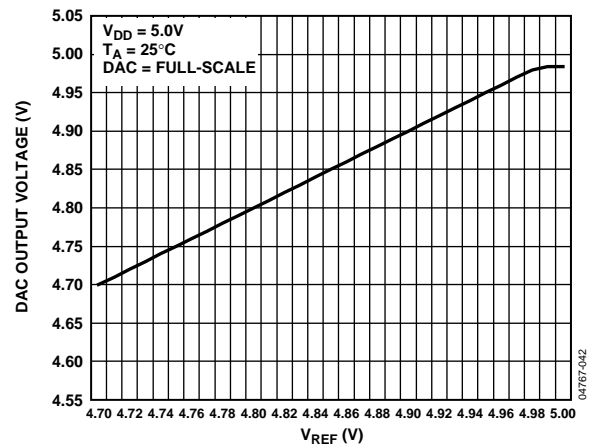

Figure 27. Output Voltage vs. Reference Voltage

¹ AD5060 only.

AD5040/AD5060



Figure 28. Typical Output vs. Supply Voltage



Figure 31. Glitch upon Entering Software Power-Down to Zero Scale

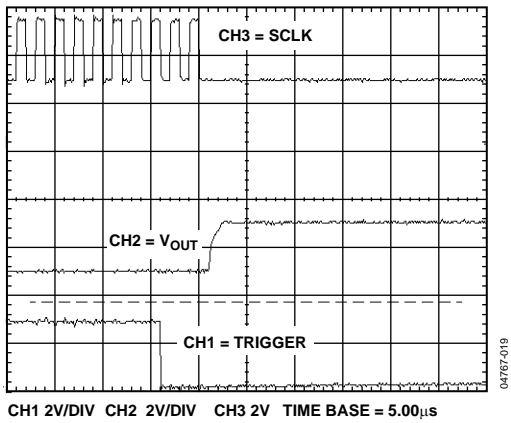

Figure 29. Time to Exit Power-Down to Midscale



Figure 32. Glitch upon Exiting Software Power-Down to Zero Scale



Figure 30. Noise Spectral Density



Figure 33. Glitch upon Entering Hardware Power-Down to Three-State

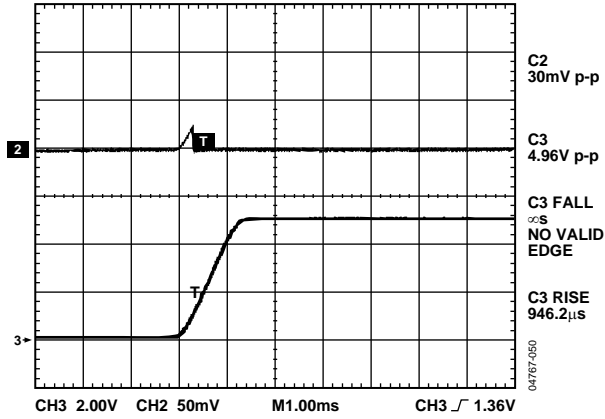

Figure 34. Glitch upon Exiting Hardware Power-Down to Zero Scale

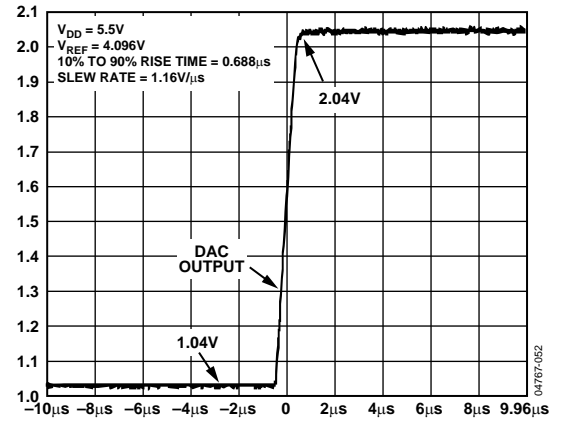

Figure 37. Typical Output Slew Rate

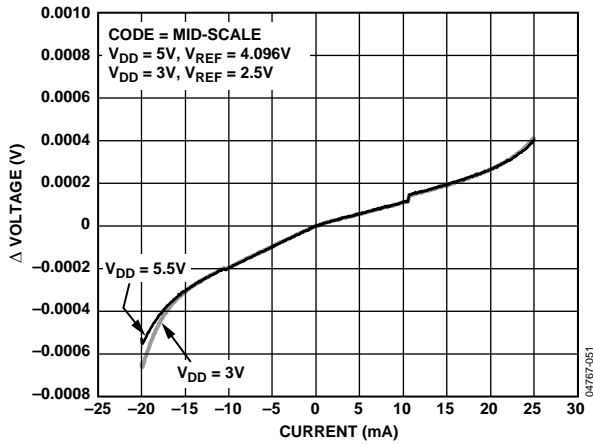

Figure 35. Typical Output Load Regulation

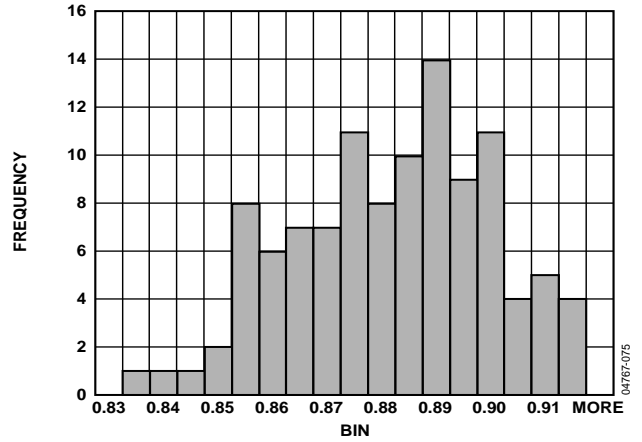

Figure 38. I_{DD} Histogram $V_{DD} = 3.0V$



Figure 36. Typical Current Limiting Plot

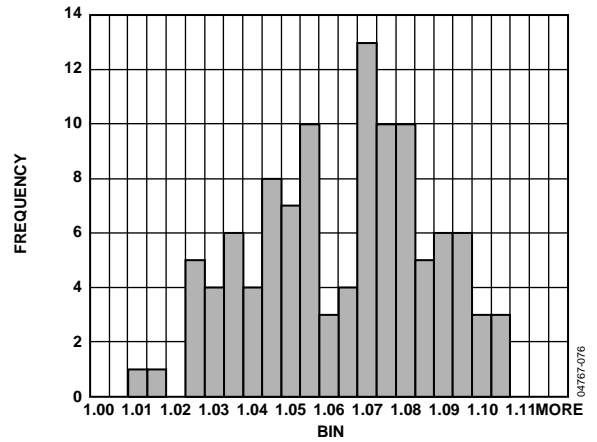

Figure 39. I_{DD} Histogram $V_{DD} = 5.0V$

TERMINOLOGY

Relative Accuracy

For the DAC, relative accuracy or integral nonlinearity (INL) is a measure of the maximum deviation, in LSBs, from a straight line passing through the endpoints of the DAC transfer function. A typical AD5060 INL vs. code plot is shown in Figure 4.

Differential Nonlinearity (DNL)

Differential nonlinearity is the difference between the measured change and the ideal 1 LSB change between any two adjacent codes. A specified differential nonlinearity of ± 1 LSB maximum ensures monotonicity. This DAC is guaranteed monotonic by design. A typical AD5060 DNL vs. code plot is shown in Figure 5.

Offset Error

Offset error is a measure of the output error when zero code (0x0000) is loaded to the DAC register. Ideally, the output should be 0 V. The zero-code error is always positive in the AD5040/AD5060 because the output of the DAC cannot go below 0 V. This is due to a combination of the offset errors in the DAC and output amplifier. Zero-code error is expressed in mV.

Full-Scale Error

Full-scale error is a measure of the output error when full-scale code (0xFFFF AD5060, 0x3FFF AD5040) is loaded to the DAC register. Ideally, the output should be $V_{DD} - 1$ LSB. Full-scale error is expressed in percent of full-scale range.

Gain Error

This is a measure of the span error of the DAC. It is the deviation in slope of the DAC transfer characteristic from ideal, expressed as a percent of the full-scale range.

Total Unadjusted Error (TUE)

Total unadjusted error is a measure of the output error taking all the various errors into account. A typical AD5060 TUE vs. code plot is shown in Figure 6.

Offset Error Drift

This is a measure of the change in zero-code error with a change in temperature. It is expressed in $\mu\text{V}/^\circ\text{C}$.

Gain Error Drift

This is a measure of the change in gain error with changes in temperature. It is expressed in (ppm of full-scale range)/ $^\circ\text{C}$.

Digital-to-Analog Glitch Impulse

Digital-to-analog glitch impulse is the impulse injected into the analog output when the input code in the DAC register changes state. It is normally specified as the area of the glitch in nV-s and is measured when the digital input code is changed by 1 LSB at the worst case code 53786; see Figure 23 and Figure 24. The expanded view in Figure 23 shows the glitch generated following completion of the calibration routine; Figure 24 zooms in on this glitch.

Digital Feedthrough

Digital feedthrough is a measure of the impulse injected into the analog output of the DAC from the digital inputs of the DAC, but is measured when the DAC output is not updated. It is specified in nV-s and measured with a full-scale code change on the data bus—that is, from all 0s to all 1s, and vice versa.

AD5040/AD5060

The AD5040 input shift register is 16 bits wide; see Figure 42. PD1 and PD0 are control bits that control the operating mode of the part—normal mode or any one of two power-down modes (see Power-Down Modes section for more detail). The next 14 bits are the data bits. These are transferred to the DAC register on the 16th falling edge of SCLK.

SYNC Interrupt

In a normal write sequence for the AD5060, the SYNC line is kept low for at least 24 falling edges of SCLK, and the DAC is updated on the 24th falling edge. However, if SYNC is brought high before the 24th falling edge, the write sequence is interrupted. The shift register is reset and the write sequence is considered invalid. Neither an update of the DAC register contents nor a change in the operating mode occurs; see Figure 43. In a normal write sequence for the AD5040, the SYNC line is kept low for at least 16 falling edges of SCLK, and the DAC is updated on the 16th falling edge. However, if SYNC is brought high before the 16th falling edge, the write sequence is interrupted. The shift register is reset and the write sequence is considered invalid. Neither an update of the DAC register contents nor a change in the operating mode occurs.

POWER-ON RESET

The AD5040 and AD5060 both contain a power-on reset circuit that controls the output voltage during power-up. The DAC register is filled with the zero-scale code or midscale code and the output voltage is set to zero scale or midscale (see the Ordering Guide for more details on the reset model). It remains there until a valid write sequence is made to the DAC. This is useful in applications where it is important to know the output state of the DAC while it is in the process of powering up.

SOFTWARE RESET

The AD5060 device can be put into software reset by setting all bits in the DAC register to 1; this includes writing 1s to Bit D23 and Bit D16, which is not the normal mode of operation. For the AD5040 this includes writing 1s to Bit D15 and Bit D14, which is also not the normal mode of operation. Note that the SYNC interrupt command cannot be performed if a software reset command is started in the AD5040 or AD5060.



Figure 42. AD5040 Input Register Content



Figure 43. AD5060 SYNC Interrupt Facility

POWER-DOWN MODES

The AD5060 features four operating modes, and the AD5040 features three operating modes. These modes are software programmable by setting two bits in the control register (Bit DB17 and Bit DB16 in the AD5060 and Bit DB15 and Bit DB14 in the AD5040). Table 6 and Table 7 show how the state of the bits corresponds to the operating mode of the two devices.

Table 6. Operating Modes for the AD5060

| DB17 | DB16 | Operating Mode |
|------|------|------------------------------|
| 0 | 0 | Normal operation |
| 0 | 1 | Power-down modes: 3-state |
| 1 | 0 | 100 kΩ to GND |
| 1 | 1 | 1 kΩ to GND |

Table 7. Operating Modes for the AD5040

| DB15 | DB14 | Operating Mode |
|------|------|------------------------------|
| 0 | 0 | Normal operation |
| 0 | 1 | Power-down modes: 3-state |
| 1 | 0 | 100 kΩ to GND |
| 1 | 1 | See Software Reset section |

In both the AD5060 and the AD5040, when the two most significant bits are set to 0, the part has normal power consumption. However, for the three power-down modes of the AD5060 and the two power down modes of the AD5040, the supply current falls to less than 1μA at 5 V (65 nA at 3 V). Not only does the supply current fall, but the output stage is also internally switched from the output of the amplifier to a resistor network of known values. This is advantageous because the output impedance of the part is known while the part is in power-down mode. The output is connected internally to GND through a 1 kΩ resistor (AD5060 only) or a 100 kΩ resistor, or it is left open-circuited (three-stated). The output stage is illustrated in Figure 44.

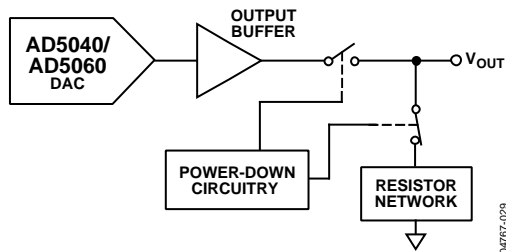

Figure 44. Output Stage During Power-Down

The bias generator, the DAC core, and other associated linear circuitry are all shut down when power-down mode is activated. However, the contents of the DAC register are unaffected when in power-down. The time to exit power-down is typically 2.5 μs for V_{DD} = 5 V, and 5 μs for V_{DD} = 3 V; see Figure 29.

MICROPROCESSOR INTERFACING

AD5040/AD5060 to ADSP-2101/ADSP-2103 Interface

Figure 45 shows a serial interface between the AD5040/AD5060 and the ADSP-2101/ADSP-2103. The ADSP-2101/ADSP-2103 should be set up to operate in the SPORT transmit alternate framing mode. The ADSP-2101/ADSP-2103 sport is programmed through the SPORT control register and should be configured for internal clock operation, active low framing, and 16-bit word length. Transmission is initiated by writing a word to the Tx register after the SPORT has been enabled.

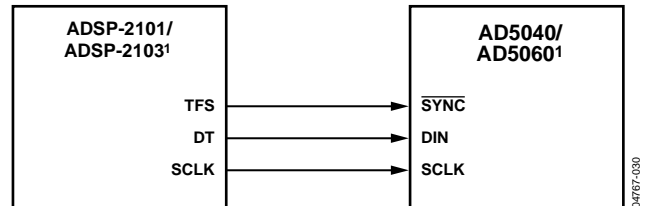

¹ADDITIONAL PINS OMITTED FOR CLARITY

Figure 45. AD5040/AD5060 to ADSP-2101/ADSP-2103 Interface

AD5040/AD5060 to 68HC11/68L11 Interface

Figure 46 shows a serial interface between the AD5040/AD5060 and the 68HC11/68L11 microcontroller. SCK of the 68HC11/68L11 drives the SCLK pin of the AD5040/AD5060, while the MOSI output drives the serial data line of the DAC. The SYNC signal is derived from a port line (PC7). The setup conditions for correct operation of this interface require that the 68HC11/68L11 be configured so that its CPOL bit is 0 and its CPHA bit is 1. When data is being transmitted to the DAC, the SYNC line is taken low (PC7). When the 68HC11/68L11 is configured where its CPOL bit is 0 and its CPHA bit is 1, data appearing on the MOSI output is valid on the falling edge of SCK. Serial data from the 68HC11/68L11 is transmitted in 8-bit bytes with only 8 falling clock edges occurring in the transmit cycle. Data is transmitted MSB first. In order to load data to the AD5040/AD5060, PC7 is left low after the first eight bits are transferred, and a second serial write operation is performed to the DAC. PC7 is taken high at the end of this procedure.



¹ADDITIONAL PINS OMITTED FOR CLARITY

Figure 46. AD5040/AD5060 to 68HC11/68L11 Interface

AD5040/AD5060

AD5040/AD5060 to Blackfin® ADSP-BF53x Interface

Figure 47 shows a serial interface between the AD5040/AD5060 and the Blackfin ADSP-53x microprocessor. The ADSP-BF53x processor family incorporates two dual-channel synchronous serial ports, SPORT1 and SPORT0, for serial and multiprocessor communications. Using SPORT0 to connect to the AD5040/AD5060, the setup for the interface is: DT0PRI drives the SDIN pin of the AD5040/AD5060, while TSCLK0 drives the SCLK of the part; the SYNC is driven from TFS0.



¹ADDITIONAL PINS OMITTED FOR CLARITY

Figure 47. AD5040/AD5060 to Blackfin® ADSP-BF53x Interface

AD5040/AD5060 to 80C51/80L51 Interface

Figure 48 shows a serial interface between the AD5060/AD5040 and the 80C51/80L51 microcontroller. The setup for the interface is: TxD of the 80C51/80L51 drives SCLK of the AD5040/AD5060 while RxD drives the serial data line of the part. The SYNC signal is again derived from a bit-programmable pin on the port. In this case, Port Line P3.3 is used. When data is to be transmitted to the AD5040, P3.3 is taken low. The 80C51/80L51 transmits data only in 8-bit bytes; thus only 8 falling clock edges occur in the transmit cycle. To load data to the DAC, P3.3 is left low after the first eight bits are transmitted, and a second write cycle is initiated to transmit the second byte of data. P3.3 is taken high following the completion of this cycle. The 80C51/80L51 outputs the serial data in a format which has the LSB first. The AD5040/AD5060 require data to be received with the MSB as the first bit. The 80C51/80L51 transmit routine should take this into account.

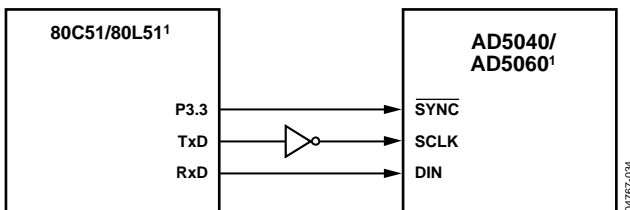

¹ADDITIONAL PINS OMITTED FOR CLARITY

Figure 48. AD5040/AD5060 to 80C51/80L51 Interface

AD5040/AD5060 to MICROWIRE Interface

Figure 49 shows an interface between the AD5040/AD5060 and any MICROWIRE-compatible device. Serial data is shifted out on the falling edge of the serial clock and is clocked into the AD5040/AD5060 on the rising edge of the SK.

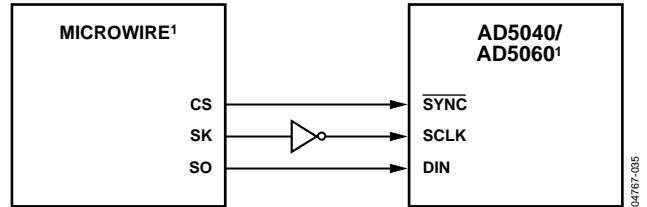

¹ADDITIONAL PINS OMITTED FOR CLARITY

Figure 49. AD5040/AD5060 to MICROWIRE Interface

APPLICATIONS

CHOOSING A REFERENCE FOR THE AD5040/AD5060

To achieve the optimum performance from the AD5040/AD5060, carefully choose a precision voltage reference. The AD5040/AD5060 have just one reference input, V_{REF} . The voltage on the reference input is used to supply the positive input to the DAC. Therefore, any error in the reference is reflected in the DAC.

There are four possible sources of error to consider when choosing a voltage reference for high accuracy applications: initial accuracy, ppm drift, long-term drift, and output voltage noise. Initial accuracy on the output voltage of the DAC leads to a full-scale error in the DAC. To minimize these errors, a reference with high initial accuracy is preferred. Also, choosing a reference with an output trim adjustment, such as an ADR43x device, allows a system designer to trim out system errors by setting a reference voltage to a voltage other than the nominal. The trim adjustment can also be used at temperature to trim out any errors.

Because the supply current required by the AD5040/AD5060 is extremely low, the parts are ideal for low supply applications. The ADR395 voltage reference is recommended. This requires less than 100 μ A of quiescent current and can, therefore, drive multiple DACs in one system, if required. It also provides very good noise performance at 8 μ V p-p in the 0.1 Hz to 10 Hz range.

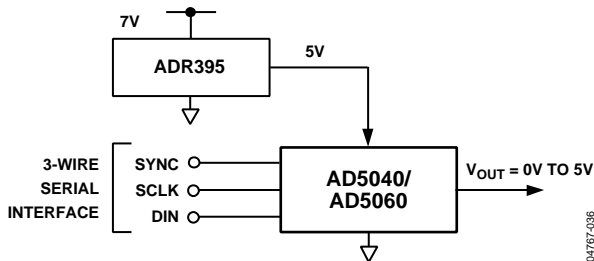

Figure 50. ADR395 as Reference to AD5060/AD5040

Long-term drift is a measure of how much the reference drifts over time. A reference with a tight long-term drift specification ensures that the overall solution remains relatively stable during its entire lifetime. The temperature coefficient of a reference output voltage affects INL, DNL, and TUE. A reference with a tight temperature coefficient specification should be chosen to reduce the temperature dependence of the DAC output voltage on ambient conditions.

In high accuracy applications, which have a relatively low noise budget, reference output voltage noise needs to be considered. It is important to choose a reference with as low an output noise voltage as practical for the system noise resolution required. Precision voltage references, such as the ADR435, produce low

output noise in the 0.1 Hz to 10 Hz region. Table 8 shows examples of recommended precision references for use as a supply to the AD5040/AD5060.

Table 8. Precision References for the AD5040/AD5060

| Part No. | Initial Accuracy (mV max) | Temp. Drift (ppm/°C max) | 0.1 Hz to 10 Hz Noise (μ V p-p typ) |
|----------|---------------------------|--------------------------|--|
| ADR435 | ± 2 | 3 (SO-8) | 8 |
| ADR425 | ± 2 | 3 (SO-8) | 3.4 |
| ADR02 | ± 3 | 3 (SO-8) | 10 |
| ADR02 | ± 3 | 3 (SC70) | 10 |
| ADR395 | ± 5 | 9 (TSOT-23) | 8 |

BIPOLAR OPERATION USING THE AD5040/AD5060

The AD5040/AD5060 have been designed for single-supply operation, but a bipolar output range is also possible using the circuit in Figure 51. The circuit shown yields an output voltage range of ± 5 V. Rail-to-rail operation at the amplifier output is achievable using an AD8675/AD820/AD8032 or an OP196/OP295.

The output voltage for any input code can be calculated as

$$V_O = \left[V_{DD} \times \left(\frac{D}{65536} \right) \times \left(\frac{R1 + R2}{R1} \right) - V_{DD} \times \left(\frac{R2}{R1} \right) \right]$$

where D represents the input code in decimal (0 to 65536, AD5060).

With $V_{REF} = 5$ V, $R1 = R2 = 10$ k Ω :

$$V_O = \left(\frac{10 \times D}{65536} \right) - 5$$

Using the AD5060, this is an output voltage range of ± 5 V with 0x0000 corresponding to a -5 V output and 0xFFFF corresponding to a $+5$ V output.

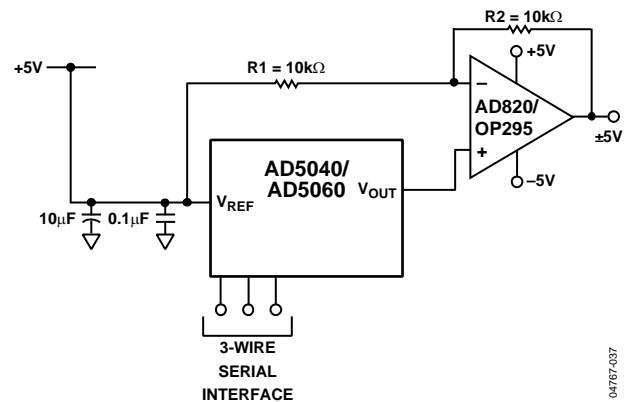

Figure 51. Bipolar Operation with the AD5040/AD5060

AD5040/AD5060

USING THE AD5040/AD5060 WITH A GALVANICALLY ISOLATED INTERFACE CHIP

In process control applications in industrial environments, it is often necessary to use a galvanically isolated interface to protect and isolate the controlling circuitry from any hazardous common-mode voltages that can occur in the area where the DAC is functioning. *iCoupler*[®] provides isolation in excess of 2.5 kV. Because the AD5040/AD5060 use a 3-wire serial logic interface, the ADuM130x family provides an ideal digital solution for the DAC interface.

The ADuM130x isolators provide three independent isolation channels in a variety of channel configurations and data rates. They operate across the full range from 2.7 V to 5.5 V, providing compatibility with lower voltage systems as well as enabling a voltage translation functionality across the isolation barrier.

Figure 52 shows a typical galvanically isolated configuration using the AD5040/AD5060. The power supply to the part also needs to be isolated; this is accomplished by using a transformer. On the DAC side of the transformer, a 5 V regulator provides the 5 V supply required for the AD5040/AD5060.



Figure 52. AD5040/AD5060 with a Galvanically Isolated Interface

POWER SUPPLY BYPASSING AND GROUNDING

When accuracy is important in a circuit, it is helpful to carefully consider the power supply and ground return layout on the board. The printed circuit board containing the AD5040/AD5060 should have separate analog and digital sections, each having its own area of the board. If the AD5040/AD5060 are in a system where other devices require an AGND-to-DGND connection, the connection should be made at one point only. This ground point should be as close as possible to the AD5040/AD5060.

The power supply to the AD5040/AD5060 should be bypassed with 10 μ F and 0.1 μ F capacitors. The capacitors should be physically as close as possible to the device with the 0.1 μ F capacitor ideally right up against the device. The 10 μ F capacitors are the tantalum bead type. It is important that the 0.1 μ F capacitor has low effective series resistance (ESR) and effective series inductance (ESI), as do common ceramic types of capacitors. This 0.1 μ F capacitor provides a low impedance path to ground for high frequencies caused by transient currents due to internal logic switching.

The power supply line itself should have as large a trace as possible to provide a low impedance path and reduce glitch effects on the supply line. Clocks and other fast switching digital signals should be shielded from other parts of the board by a digital ground. Avoid crossover of digital and analog signals, if possible. When traces cross on opposite sides of the board, ensure that they run at right angles to each other to reduce feedthrough effects on the board. The best board layout technique is the microstrip technique where the component side of the board is dedicated to the ground plane only, and the signal traces are placed on the solder side. However, this is not always possible with a two-layer board.

OUTLINE DIMENSIONS



COMPLIANT TO JEDEC STANDARDS MO-178-BA

Figure 53. 8-Lead Small Outline Transistor Package [SOT-23]
(RJ-8)
Dimensions shown in millimeters

121608-A

ORDERING GUIDE

| Model ¹ | Temperature Range | Maximum INL | Description | Package Description | Package Option | Branding |
|--------------------|-------------------|-------------|------------------------------------|---------------------|----------------|----------|
| AD5040BRJZ-500RL7 | -40°C to +85°C | 1 LSB | 2.7 V to 5.5 V, reset to 0 V | 8 Lead SOT-23 | RJ-8 | D4C |
| AD5040BRJZ-REEL7 | -40°C to +85°C | 1 LSB | 2.7 V to 5.5 V, reset to 0 V | 8 Lead SOT-23 | RJ-8 | D4C |
| AD5060ARJZ-1500RL7 | -40°C to +85°C | 2 LSB | 2.7 V to 5.5 V, reset to 0 V | 8 Lead SOT-23 | RJ-8 | D3Z |
| AD5060ARJZ-1REEL7 | -40°C to +85°C | 2 LSB | 2.7 V to 5.5 V, reset to 0 V | 8 Lead SOT-23 | RJ-8 | D3Z |
| AD5060ARJZ-2REEL7 | -40°C to +85°C | 2 LSB | 2.7 V to 5.5 V, reset to mid-scale | 8 Lead SOT-23 | RJ-8 | D41 |
| AD5060ARJZ-2500RL7 | -40°C to +85°C | 2 LSB | 2.7 V to 5.5 V, reset to mid-scale | 8 Lead SOT-23 | RJ-8 | D41 |
| AD5060BRJZ-1500RL7 | -40°C to +85°C | 1 LSB | 2.7 V to 5.5 V, reset to 0 V | 8 Lead SOT-23 | RJ-8 | D3W |
| AD5060BRJZ-1REEL7 | -40°C to +85°C | 1 LSB | 2.7 V to 5.5 V, reset to 0 V | 8 Lead SOT-23 | RJ-8 | D3W |
| AD5060BRJZ-2REEL7 | -40°C to +85°C | 1 LSB | 2.7 V to 5.5 V, reset to mid-scale | 8 Lead SOT-23 | RJ-8 | D3X |
| AD5060BRJZ-2500RL7 | -40°C to +85°C | 1 LSB | 2.7 V to 5.5 V, reset to mid-scale | 8 Lead SOT-23 | RJ-8 | D3X |
| AD5060YRJZ-1500RL7 | -40°C to +125°C | ±1.5 LSB | 2.7 V to 5.5 V, reset to 0 V | 8 Lead SOT-23 | RJ-8 | D6F |
| AD5060YRJZ-1REEL7 | -40°C to +125°C | ±1.5 LSB | 2.7 V to 5.5 V, reset to 0 V | 8 Lead SOT-23 | RJ-8 | D6F |
| EVAL-AD5060EBZ | | | | Evaluation Board | | |

¹ Z = RoHS Compliant Part.

NOTES

NOTES

NOTES

Данный компонент на территории Российской Федерации

Вы можете приобрести в компании MosChip.

Для оперативного оформления запроса Вам необходимо перейти по данной ссылке:

<http://moschip.ru/get-element>

Вы можете разместить у нас заказ для любого Вашего проекта, будь то серийное производство или разработка единичного прибора.

В нашем ассортименте представлены ведущие мировые производители активных и пассивных электронных компонентов.

Нашей специализацией является поставка электронной компонентной базы двойного назначения, продукции таких производителей как XILINX, Intel (ex.ALTERA), Vicor, Microchip, Texas Instruments, Analog Devices, Mini-Circuits, Amphenol, Glenair.

Сотрудничество с глобальными дистрибьюторами электронных компонентов, предоставляет возможность заказывать и получать с международных складов практически любой перечень компонентов в оптимальные для Вас сроки.

На всех этапах разработки и производства наши партнеры могут получить квалифицированную поддержку опытных инженеров.

Система менеджмента качества компании отвечает требованиям в соответствии с ГОСТ Р ИСО 9001, ГОСТ РВ 0015-002 и ЭС РД 009

Офис по работе с юридическими лицами:

105318, г.Москва, ул.Щербаковская д.3, офис 1107, 1118, ДЦ «Щербаковский»

Телефон: +7 495 668-12-70 (многоканальный)

Факс: +7 495 668-12-70 (доб.304)

E-mail: info@moschip.ru

Skype отдела продаж:

moschip.ru

moschip.ru_4

moschip.ru_6

moschip.ru_9