

REVISIONS	DATE	BY	CHKD
18 JAN 98	18 JAN 98	WJC	SAV
19 JAN 98	19 JAN 98	DGD	DGD
18 JAN 06	18 JAN 06	DGD	DGD

WJC	5 JAN 98	CHECK	SAV	19 JAN 98	CHECK	DGD	18 JAN 06	CHECK	DGD	RELEASE NO.	DR-4996	REPLACES	-
-----	----------	-------	-----	-----------	-------	-----	-----------	-------	-----	-------------	---------	----------	---

MICRO SWITCH
a Honeywell Division
SOLID STATE SENSOR
SS5 SERIES CHART 1

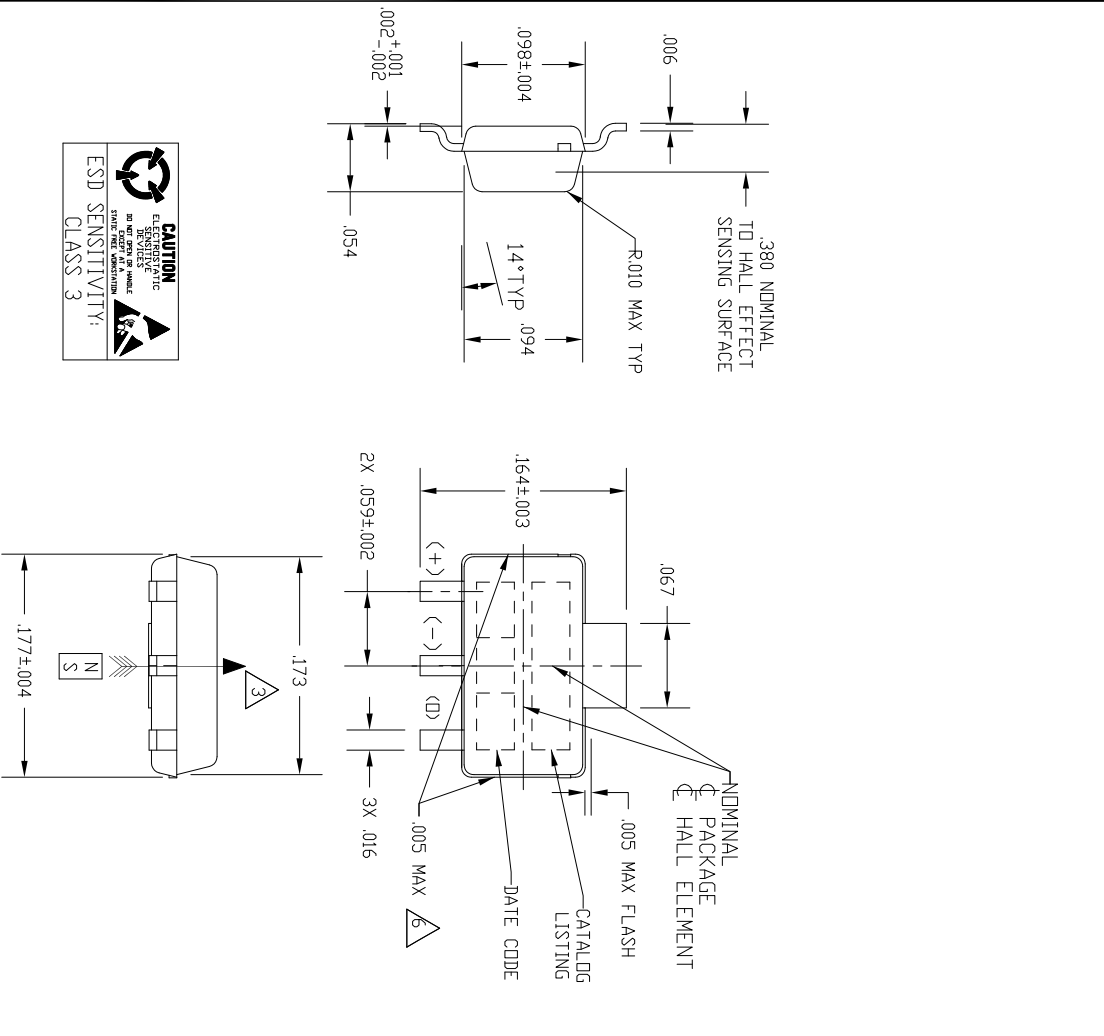

REV	DOCUMENT	CHANGED BY	CHECK
13	0024233	MCP 07SEF06	LG

REV	DATE	BY	CHKD
18 JAN 98	18 JAN 98	WJC	SAV
19 JAN 98	19 JAN 98	DGD	DGD
18 JAN 06	18 JAN 06	DGD	DGD

NOTES
1 - SOLDERING INSTRUCTIONS: EXPOSURE TO HIGH TEMPERATURES SHOULD BE KEPT AT A MINIMUM MICRO SWITCH RECOMMENDS AN INFRARED REFLOW PROCESS WITH PEAK TEMPERATURES NOT EXCEEDING 245°C (473°F) FOR 10 SECONDS MAXIMUM. DO NOT WAVE SOLDER THIS PRODUCT AS THIS PROCESS MAY NEGATIVELY AFFECT THE SENSOR'S PERFORMANCE AND RELIABILITY. SUBJECTING THESE PRODUCTS TO WAVE SOLDERING WILL VOID MICRO SWITCH'S WARRANTY.

- 2 - ABSOLUTE MAXIMUM RATINGS ARE THE EXTREME LIMITS THE DEVICE WILL MOMENTARILY WITHSTAND WITHOUT DAMAGE TO THE DEVICE. ELECTRICAL AND MAGNETIC CHARACTERISTICS ARE NOT GUARANTEED IF THE SPECIFIED VOLTAGE AND/OR CURRENTS ARE EXCEEDED. NDR WILL THE DEVICE NECESSARILY OPERATE AT ABSOLUTE MAXIMUM RATING.
- 3 - THE MAGNETIC FLUX USED TO OPERATE THE SWITCH MUST BE IN THE DIRECTION AND LOCATION SHOWN. (THIS ASSUMES THE CONVENTION THAT THE DIRECTION OF THE EXTERNAL FLUX OF A MAGNET IS FROM THE NORTH TO THE SOUTH POLE OF THE MAGNET.)
- 4 - THE MAGNETIC FIELD STRENGTH (GAUSS) REQUIRED TO CAUSE THE SWITCH TO CHANGE STATE (OPERATE AND RELEASE) WILL BE AS SPECIFIED IN THE MAGNETIC CHARACTERISTICS. TO TEST THE SWITCH AGAINST THE SPECIFIED MAGNETIC CHARACTERISTICS, THE SWITCH MUST BE PLACED IN A UNIFORM MAGNETIC FIELD.
- 5 - A "T" SUFFIX ON ANY CATALOG LISTING DESIGNATES THE PRODUCT WILL BE SUPPLIED IN TAPE AND REEL FORM PER EIA STD 481. SS5 SERIES SOLD IN TAPE AND REEL ONLY. SOME BASIC LISTINGS MAY NOT BE AVAILABLE GATE VESAGE PERMITTED IN THESE AREAS. UNDERFLUSH BREAKOUT LIMITED TO .007.
- 6 - THESE HALL EFFECT SENSORS MAY HAVE AN INITIAL OUTPUT IN EITHER THE ON OR OFF STATE IF POWERED UP WITH AN APPLIED MAGNETIC FIELD IN THE DIFFERENTIAL ZONE (APPLIED MAGNETIC FIELD > BPP AND < BOP). MICRO SWITCH RECOMMENDS THAT THE APPLICATION CIRCUIT DESIGNER ALLOW 10 MICROSECONDS AFTER SUPPLY VOLTAGE HAS REACHED 5 VOLTS FOR THE OUTPUT VOLTAGE TO STABILIZE.

CONVERSION TO METRIC DIMENSIONS			
DIMENSION	METRIC EQUIVALENT, MM	DIMENSION	METRIC EQUIVALENT, MM
.001	0.025	.095	2.413
.002	0.051	.098	2.489
.003	0.076	.157	3.988
.004	0.102	.164	4.166
.005	0.127	.173	4.394
.006	0.152	.177	4.496
.007	0.178	.181	4.597
.008	0.203	.197	5.004
.015	0.381	.217	5.512
.016	0.406	.230	5.842
.030	0.762	.314	7.976
.031	0.787	.315	8.001
.038	0.965	.472	11.989
.050	1.270	.480	12.192
.059	1.499	.512	13.005
.067	1.702	.724	18.390
.069	1.753	1.300	33.020
.078	1.981	1.970	50.038
.079	2.007	7.010	178.054
.094	2.388	10.000	254.000

THIRD ANGLE PROJECTION
DO NOT SCALE PRINT
SCALE NONE
UNLESS OTHERWISE SPECIFIED TOLERANCES ARE:
ONE PLACE (.00) +0.0 0.3
TWO PLACE (.000) +0.015
THREE PLACE (.0000) +0.005
ANGLES
WEIGHT

MICRO SWITCH
a Honeywell Division
FED. REG. CODE 91929

SOLID STATE SENSOR

SS5 SERIES CHART 1

CATALOG LISTING

THIS DRAWING COVERS A PROPRIETARY ITEM AND IS THE PROPERTY OF MICRO SWITCH, A DIVISION OF HONEYWELL. THIS DRAWING IS NOT TO BE COPIED OR USED WITHOUT THE APPROVAL OF MICRO SWITCH.

CATALOG LISTING
SS5 SERIES CHART
PAGE 2 OF 5

ISSUE
M
14

PTC/CAD
3D
18 JAN 96
12 0018451
11 0018451
10 0018451
9 0018451
8 0018451
7 0018451
6 0018451
5 0018451
4 0018451
3 0018451
2 0018451
1 0018451
REVISIONS
B REC'DWG
C 0018451
D 0018451
E 0018451
F 0018451
G 0018451
H 0018451
I 0018451
J 0018451
K 0018451
L 0018451
M 0018451
N 0018451
O 0018451
P 0018451
Q 0018451
R 0018451
S 0018451
T 0018451
U 0018451
V 0018451
W 0018451
X 0018451
Y 0018451
Z 0018451
DRAWN
WJC
5 JAN 98
CHECK
SAV
19 JAN 98
CHECK
DGD
18 JAN 06
CHECK

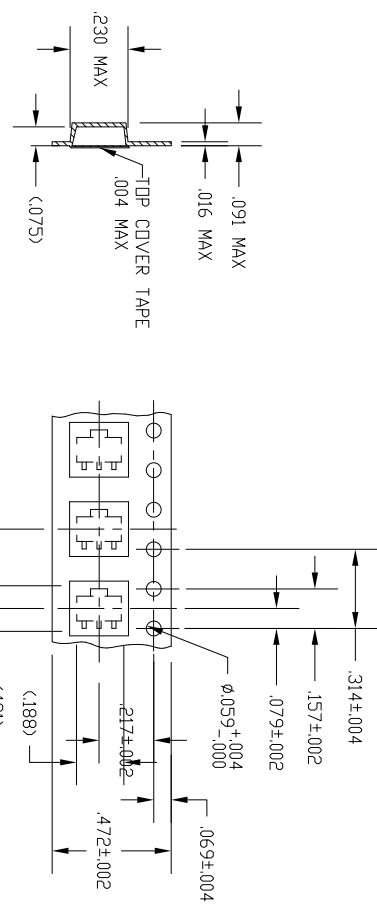

SECTION A-A
TAPES AND REEL DIMENSIONS

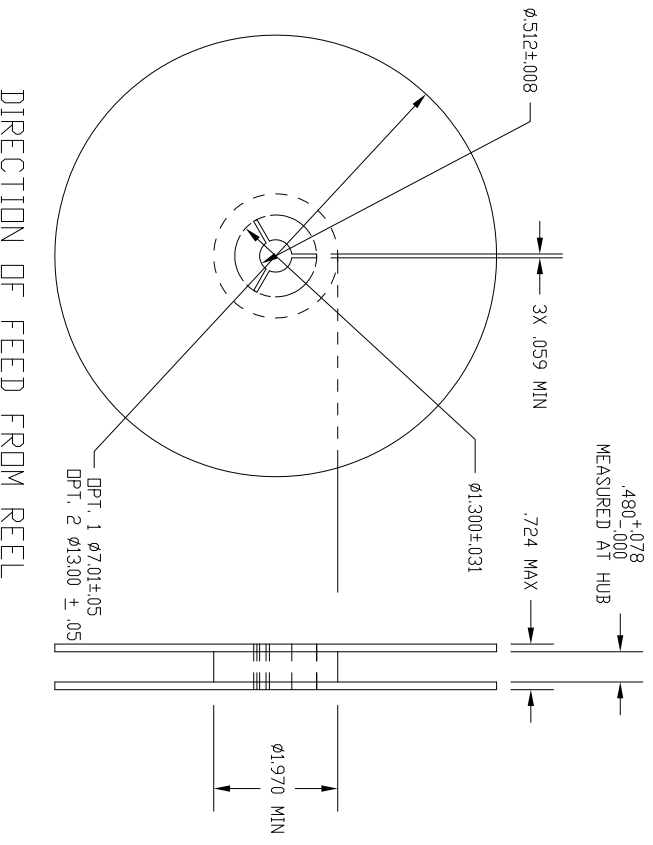

DIRECTION OF FEED FROM REEL

ANSI Y14.5M-1982 APPLIES

SS5 CATALOG SYSTEM

PREFIX
BASIC CATALOG LISTING:
PACKAGE STYLE, MAGNETIC TYPE,
ELECTRICAL/MAGNETIC SPECS

CHARACTERS IN THESE
POSITIONS OF THE LISTING
ARE BRANDED ON THE PRODUCT

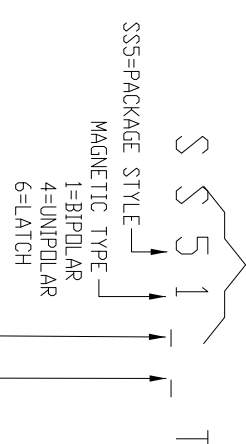

RELATIVE GAUSS OPERATING RANGE
(BLANK, 0-9, 9=HIGH GAUSS)
ELECTRICAL/MAGNETIC OPTIONS
(BLANK, A-K & U-Z)
A=STANDARD
B-K & U-Z=SPECIALS



THIRD ANGLE PROJECTION	
SCALE	NONE
DO NOT SCALE PRINT	
UNLESS TOLERANCES SPECIFIED	
TOLERANCES ARE:	
ONE PLACE	.00
TWO PLACE	+.00
THREE PLACE	+.000
ANGLES	±
WEIGHT	

MICRO SWITCH
a Honeywell Division
FED. REG. CODE 91989

SOLIC STATE SERIES

SS5 SERIES CHART 1

CATALOG LISTING

THIS DRAWING COVERS A PROPRIETARY ITEM AND IS THE PROPERTY OF MICRO SWITCH, A DIVISION OF HONEYWELL. THIS DRAWING IS NOT TO BE COPIED OR USED WITHOUT THE APPROVAL OF MICRO SWITCH.

TABLE 1 - MAGNETIC SPECIFICATIONS

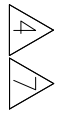

LISTING	-40°C	0°C	25°C	85°C	125°C	150°C
MIN OPERATE GAUSS						
SS511	NS	NS	NS	NS	NS	NS
SS511AT	NS	NS	NS	NS	NS	NS
SS513AT	NS	NS	NS	NS	NS	NS
SS541AT	50	53	55	45	40	35
SS543AT	110	110	110	90	80	65
SS549AT	285	305	310	290	270	260
SS561AT	5	5	10	10	5	5
SS566AT	100	100	100	95	80	70
MAX OPERATE GAUSS						
SS511	145	145	140	150	200	250
SS511AT	70	65	60	60	65	70
SS513AT	140	140	140	140	140	140
SS541AT	135	117	115	120	123	125
SS543AT	215	190	180	180	190	200
SS549AT	435	400	390	400	410	420
SS561AT	110	90	85	85	100	110
SS566AT	200	185	180	180	180	185
MIN RELEASE GAUSS						
SS511	-145	-145	-140	-150	-200	-250
SS511AT	-70	-65	-60	-60	-65	-70
SS513AT	-140	-140	-140	-140	-140	-140
SS541AT	20	20	20	15	15	10
SS543AT	80	80	75	70	60	55
SS549AT	210	230	235	215	200	185
SS561AT	-110	-90	-85	-85	-100	-110
SS566AT	-200	-185	-180	-180	-180	-185
MAX RELEASE GAUSS						
SS511	NS	NS	NS	NS	NS	NS
SS511AT	NS	NS	NS	NS	NS	NS
SS513AT	NS	NS	NS	NS	NS	NS
SS541AT	120	99	95	105	115	120
SS543AT	190	165	155	165	180	195
SS549AT	360	325	315	325	340	345
SS561AT	-5	-5	-10	-10	-5	-5
SS566AT	-100	-100	-100	-95	-80	-70
MIN DIFF GAUSS						
SS511	40	50	50	60	60	NS
SS511AT	15	15	15	12	12	10
SS513AT	20	20	20	20	20	20
SS541AT	15	15	20	15	8	5
SS543AT	25	25	25	15	10	5
SS549AT	30	30	30	30	30	30
SS561AT	50	50	50	50	50	50
SS566AT	200	200	200	190	160	140

SS5XT ELECTRICAL SPECIFICATIONS

CHARACTERISTIC	TEST CONDITIONS	UNITS
VOLTAGE RANGE	VCC = 24V, -40°C < T < 150°C, B > MAX DP	4.5 TO 24 VOLTS
MAX I _{on}	VCC = 24V, V _{out} = 24V, -40°C < T < 150°C, B < MIN REL	100 mA
MAX I _{off}	VCC = 24V, V _{out} = 24V, -40°C < T < 150°C, B < MIN REL	11.3 mA
SINK CURRENT	VCC = 45V TO 24V, T = 25°C, B > MAX DP	20 mA
MAX V _{sat}	VCC = 45V TO 24V, T = 25°C, B > MAX DP	0.4 VOLTS
MAX LEAKAGE	VCC = 12V, R	10 μA
RISE TIME	VCC = 12V, R	1.5 μS
FALL TIME	V _{off} = 12V, R	1.5 μS
90% TO 10%	V _{off} = 12V, R	1.5 μS

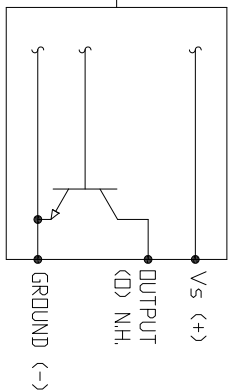
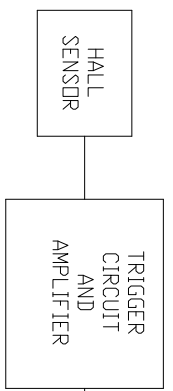

CHARACTERISTIC	TEST CONDITIONS	UNITS
VOLTAGE RANGE	VCC = 30V, -40°C < T < 150°C, B > MAX DP	3.8 TO 30 VOLTS
MAX I _{on}	VCC = 30V, V _{out} = 30V, -40°C < T < 150°C, B < MIN REL	100 mA
MAX I _{off}	VCC = 30V, V _{out} = 30V, -40°C < T < 150°C, B < MIN REL	10.0 mA
SINK CURRENT	VCC = 38V, B > MAX DP	20 mA
MAX V _{sat}	VCC = 12V, R	0.4 VOLTS
MAX LEAKAGE	VCC = 12V, R	10 μA
RISE TIME	VCC = 12V, R	1.5 μS
FALL TIME	V _{off} = 12V, R	1.5 μS
90% TO 10%	V _{off} = 12V, R	1.5 μS

SS5XXAT ELECTRICAL SPECIFICATIONS

TABLE 2	SS5XX
OUTPUT CURRENT	37
ABSOLUTE LIMITS	33
SUPPLY CURRENT	28
VOLTAGE	24
MAX. mA	19
-1 TO 24	50
24 TO 25	37
25 TO 26	33
26 TO 27	28
27 TO 28	24
28 TO 29	19
29 TO 30	15

CHARACTERISTIC	SYMBOL	MIN	MAX	UNITS
POWER SUPPLY	VCC	-1	30	VOLTS
OUTPUT VOLTAGE (OFF)	V _{OUT}		30	VOLTS
OUTPUT ON CURRENT	I _{ON}		SEE TABLE	mA
OPERATING TEMPERATURE	T	-50	60	°C
STORAGE TEMPERATURE	T _S	-65	160	°C
MAGNETIC FLUX	ND LIMIT			

LISTING	TYPE	BRAND
SS511	BIPOLAR	SS511
SS511AT	BIPOLAR	SS511A
SS513AT	BIPOLAR	SS513A
SS541AT	UNIPOLAR	SS541A
SS543AT	UNIPOLAR	SS543A
SS549AT	UNIPOLAR	SS549A
SS561AT	LATCH	SS561A
SS566AT	LATCH	SS566A

ANSI Y14.5M-1982 APPLIES

THIRD ANGLE PROJECTION
SCALE NONE
DO NOT SCALE PRINT
UNLESS OTHERWISE SPECIFIED
DIMENSIONS ARE
ONE PLACE (.0) +0.03
TWO PLACE (.00) +0.15
THREE PLACE (.000) +0.05
WEIGHT
ANGLES

MICRO SWITCH
a Honeywell Division
FED. MFG. CODE 91929

SOLID STATE SENSOR

SS5 SERIES CHART 1

CATALOG LISTING

THIS DRAWING COVERS A PROPRIETARY ITEM AND IS THE PROPERTY OF MICRO SWITCH, A DIVISION OF HONEYWELL. THIS DRAWING IS NOT TO BE COPIED OR USED WITHOUT THE APPROVAL OF MICRO SWITCH.

CATALOG LISTING
SS5 SERIES CHART
PAGE 4 OF 5

ISSUE
14

PTC/CAD 3D
DRAWN
WJC 5 JAN 98
CHECK SAV 19 JAN 98
CHECK DGD 18 JAN 06
CHECK

REVISIONS
A REC'D JMG 27 JUN 98
B 9806
C 9806
D 9806
E 200503
F 200747
G 206174
H 207146

RELEASE NO. DR-4996
REPLACES -

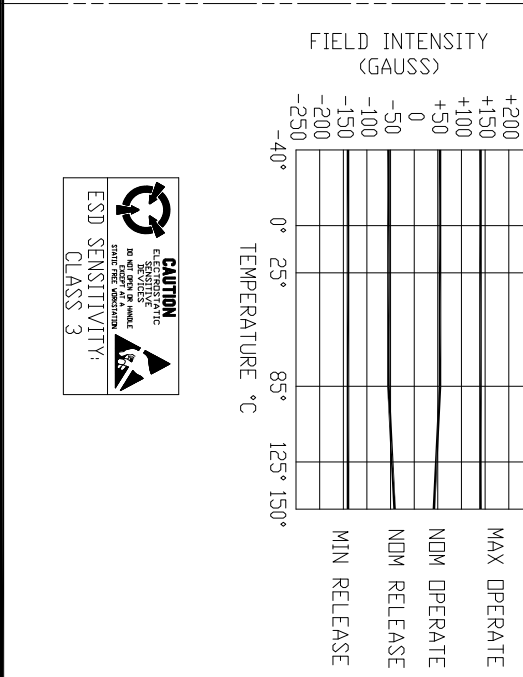
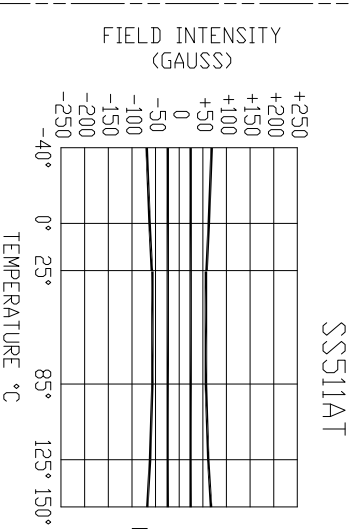
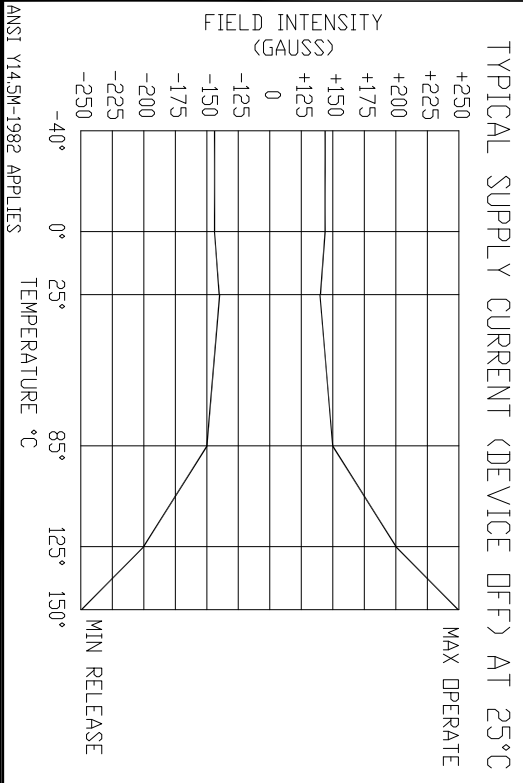
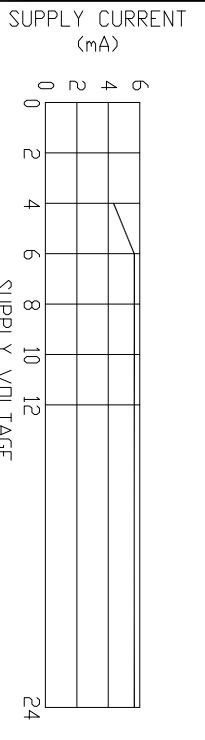
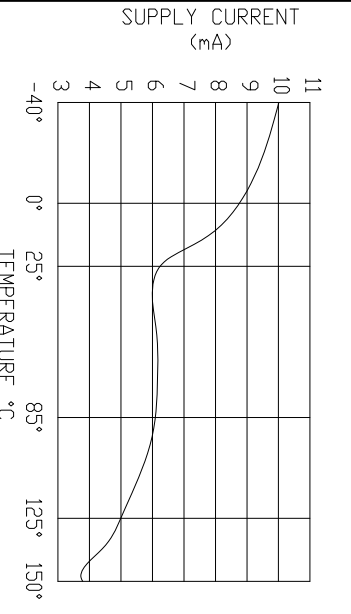

THIRD ANGLE PROJECTION
SCALE NONE
DO NOT SCALE PRINT
UNLESS TOLERANCES SPECIFIED
TOLERANCES ARE:
ONE PLACE (.00) +0.003
TWO PLACE (.000) +0.015
THREE PLACE (.0000) +0.005
ANGLES ±
WEIGHT

WJC	5 JAN 98	CHECK	SAV	19 JAN 02	CHECK	DGD	18 JAN 06	CHECK	RELEASE NO.	DR-4996	REPLACES	-
-----	----------	-------	-----	-----------	-------	-----	-----------	-------	-------------	---------	----------	---

MICRO SWITCH
a Honeywell Division
FED. MFG. CODE 91929

SOLID STATE SENSOR

CATALOG LISTING
SS5 SERIES CHART 1

THIS DRAWING COVERS A PROPRIETARY ITEM AND IS THE PROPERTY OF MICRO SWITCH, A DIVISION OF HONEYWELL. THIS DRAWING IS NOT TO BE COPIED OR USED WITHOUT THE APPROVAL OF MICRO SWITCH.

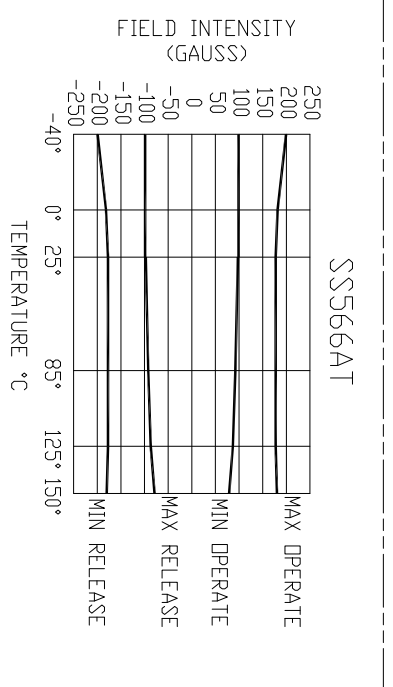
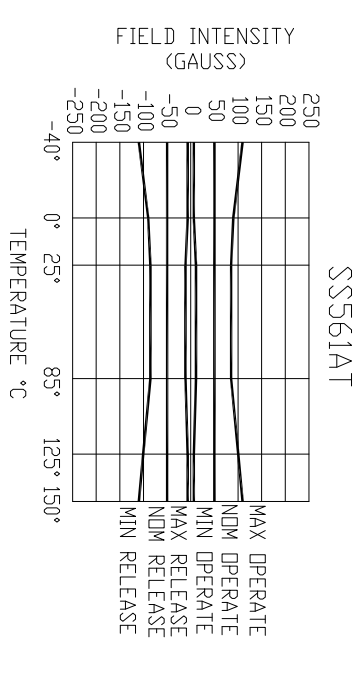
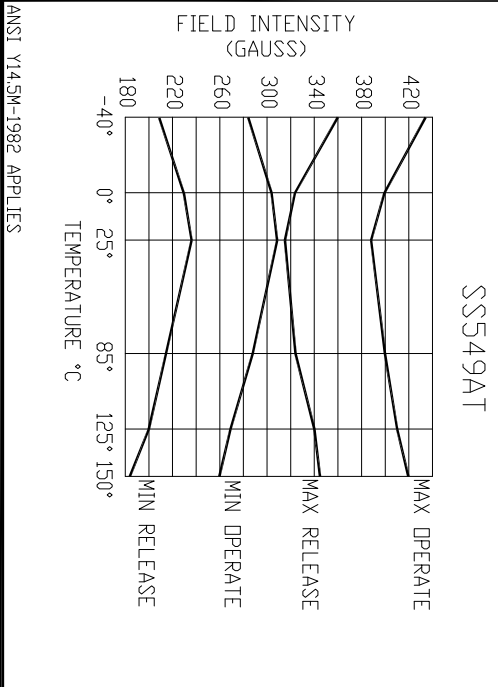
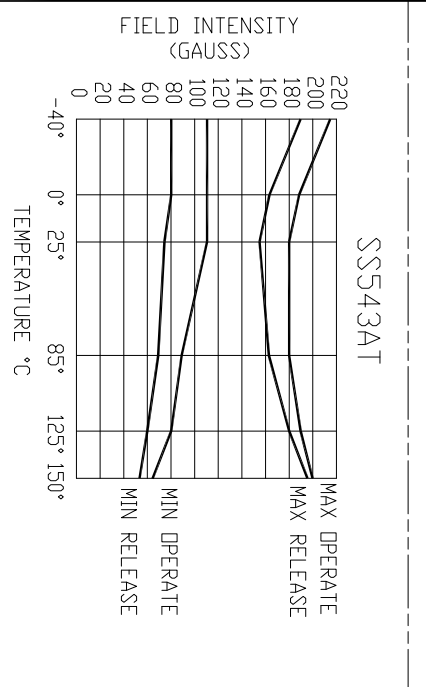
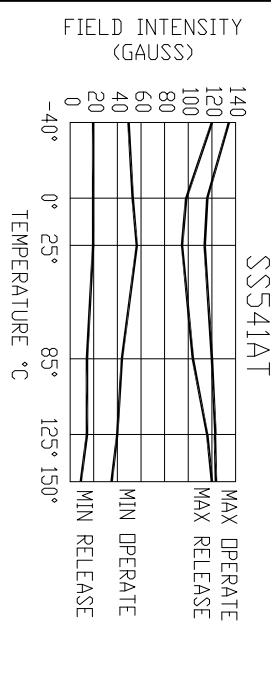

CAUTION
ELECTROSTATIC SENSITIVE DEVICE
DO NOT TOUCH SURFACE
STATE FREE OPERATION

ESD SENSITIVITY:
CLASS 3

THIRD ANGLE PROJECTION	
SCALE	NONE
DO NOT SCALE PRINT	
UNLESS TOLERANCES SPECIFIED	
ONE PLACE	(.0)
TWO PLACE	(.00)
THREE PLACE	(.000)
ANGLES	(.000) +.005
WEIGHT	

Данный компонент на территории Российской Федерации

Вы можете приобрести в компании MosChip.

Для оперативного оформления запроса Вам необходимо перейти по данной ссылке:

<http://moschip.ru/get-element>

Вы можете разместить у нас заказ для любого Вашего проекта, будь то серийное производство или разработка единичного прибора.

В нашем ассортименте представлены ведущие мировые производители активных и пассивных электронных компонентов.

Нашей специализацией является поставка электронной компонентной базы двойного назначения, продукции таких производителей как XILINX, Intel (ex.ALTERA), Vicor, Microchip, Texas Instruments, Analog Devices, Mini-Circuits, Amphenol, Glenair.

Сотрудничество с глобальными дистрибьюторами электронных компонентов, предоставляет возможность заказывать и получать с международных складов практически любой перечень компонентов в оптимальные для Вас сроки.

На всех этапах разработки и производства наши партнеры могут получить квалифицированную поддержку опытных инженеров.

Система менеджмента качества компании отвечает требованиям в соответствии с ГОСТ Р ИСО 9001, ГОСТ РВ 0015-002 и ЭС РД 009

Офис по работе с юридическими лицами:

105318, г.Москва, ул.Щербаковская д.3, офис 1107, 1118, ДЦ «Щербаковский»

Телефон: +7 495 668-12-70 (многоканальный)

Факс: +7 495 668-12-70 (доб.304)

E-mail: info@moschip.ru

Skype отдела продаж:

moschip.ru

moschip.ru_4

moschip.ru_6

moschip.ru_9