



00-9159-00X-501-X06

PREFIX

SERIES

NO. OF WAYS

CODE	NO. OF WAYS	DETAILS
002	2	SHEET 2
003	3	SHEET 3
004	4	SHEET 4
005	5	SHEET 5
006	6	SHEET 6

Elco Europe (A Division of AVX Ltd) CONFIDENTIAL PROPRIETY  
 The document on this print and information therewith are PROPRIETY  
 to Elco Europe (A Division of AVX Ltd) and shall not be copied  
 or disclosed in whole or in part without Elco Europe's written consent.

SINGLE PART PCB STRIP CONNECTOR

CODE	DESCRIPTION	DETAILS
501	THROUGH THE BOARD - EDGE CARD - NO CAP	SHEETS 2 TO 6
502	THROUGH THE BOARD - EDGE CARD - CAP FITTED	SHEET 7

INSULATOR COLOUR

CODE	COLOUR	AVAILABILITY
9	WHITE	UL APPROVED - STANDARD



PLATING OPTION

CODE	CONTACT PLATING
06	GOLD PLATING ON NOSE WITH TIN ON TAILS

SHEET 1 OF 10

FORM-106-01-056-6 ISS 7

Release No.	History
102809	10.11.2011
	06.01.2012
	12.01.2012
	03.02.2012
	08.02.2012
	28.03.2012
	102876
	26.04.2012
	102879
	14.05.2012
	26.06.2012
	24.07.2012

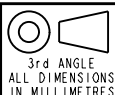

**ELCO**  
 © COPYRIGHT ELCO EUROPE  
 NOT TO BE DISCLOSED OR COPIED  
 WITHOUT WRITTEN PERMISSION

Drawn	N.C.H.
Size	CV

Description	9159 THROUGH BOARD - ORDERING CODE
Part Number	00-9159-01_500S

DATE	06-Jan-12
Issue	6



**THROUGH THE BOARD MATING EDGE CARD CONNECTOR - 2 WAY**

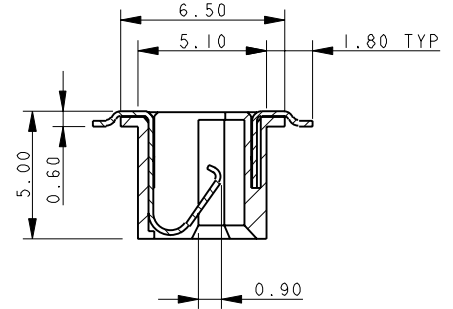
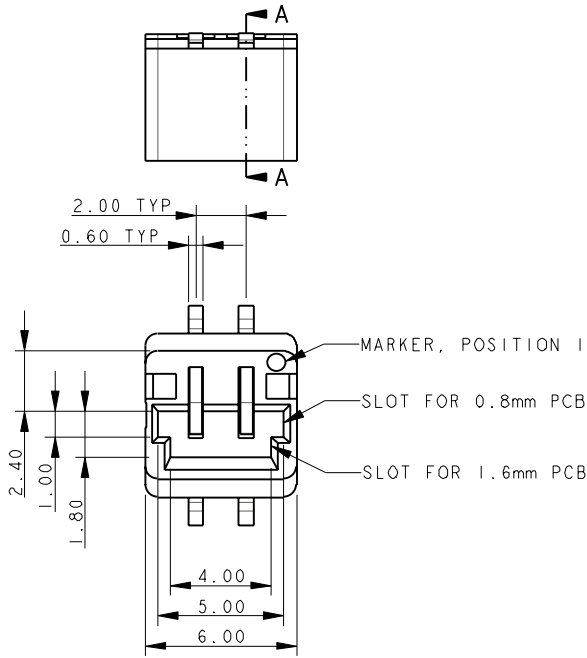

**SECTION A-A**

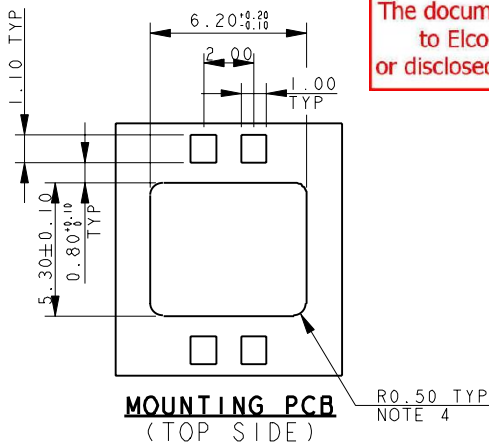
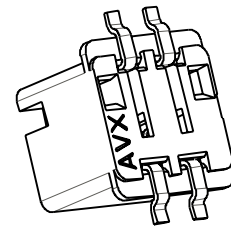

Elco Europe (A Division of AVX Ltd) CONFIDENTIAL PROPRIETY  
The document on this print and information therewith are PROPRIETY  
to Elco Europe (A Division of AVX Ltd) and shall not be copied  
or disclosed in whole or in part without Elco Europe's written consent.

**PACKING DETAILS**

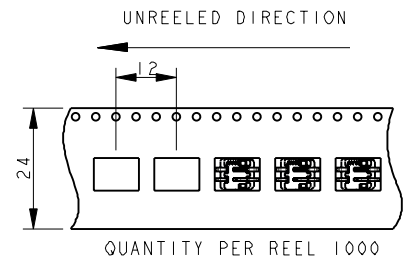
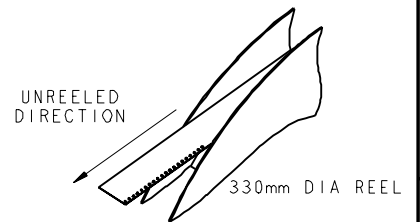

**NOTES :-**

1. THROUGH THE BOARD 2 WAY EDGE CARD CONNECTOR. FOR FURTHER DETAILS REFER TO PRODUCT SPECIFICATION 201-01-136.
2. FOR MATING PCB EITHER 0.8mm OR 1.6mm THICK. REFER TO SHEET 7 FOR MATING PCB DETAILS.
3. CONNECTOR TOP MOUNTING ON PCB.
4. UP TO 0.5mm RAD TO MATCH CONNECTOR PROFILE.
5. ALL DIMENSIONS ±0.20 UNLESS TOLERANCE SPECIFIED.
6. INSULATOR :- PA4T, GLASS FILLED, HALOGEN FREE, UL94 V-0, COLOUR REFER TO SHEET 1.
7. CONTACT :- COPPER ALLOY, NICKEL PLATED WITH GOLD FLASH ON NOSE AND TIN ON TAILS.
8. BRACKET :- COPPER ALLOY, PLATING, TIN OVER NICKEL.
9. PACKING IN TAPE AND REEL, 1000 PIECES PER REEL.
10. CONTACT TAILS COPLANARITY WITHIN 0.10.
11. REFER TO SHEET 10 FOR MATCHING PROTECTING CAP.
12. UL REFERENCE E90723.

ELCO EUROPE (A DIVISION OF AVX LTD.) CONFIDENTIAL PROPRIETARY  
THE DRAWING ON THIS PRINT AND INFORMATION THEREWITH ARE PROPRIETARY TO ELCO EUROPE (A DIVISION OF AVX LTD.) AND SHALL NOT BE USED OR DISCLOSED IN WHOLE OR IN PART WITHOUT ELCO EUROPE'S WRITTEN CONSENT.

Release No.	102809
History	10.11.2011
	06.01.2012
	12.01.2012
	03.02.2012
	08.02.2012
	08.03.2012
	28.03.2012
	102876
	26.04.2012
	102879
	14.03.2012
	26.06.2012
	24.07.2012

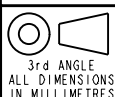

**ELCO**  
© COPYRIGHT ELCO EUROPE  
NOT TO BE DISCLOSED OR COPIED  
WITHOUT WRITTEN PERMISSION

Drawn	N.C.H.	Description	9159 THROUGH BOARD - ORDERING CODE	DATE	06-Jan-12
Size	CV	Part Number	00-9159-01_500S	Issue	6

SHEET 2 OF 10

FORM-106-01-056-6 ISS 7



**THROUGH THE BOARD MATING EDGE CARD CONNECTOR - 3 WAY**

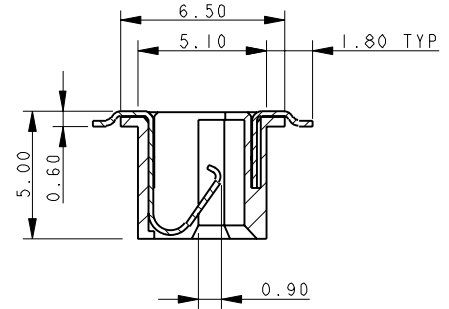
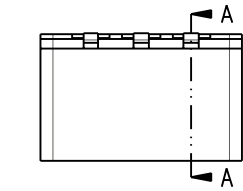

**SECTION A-A**

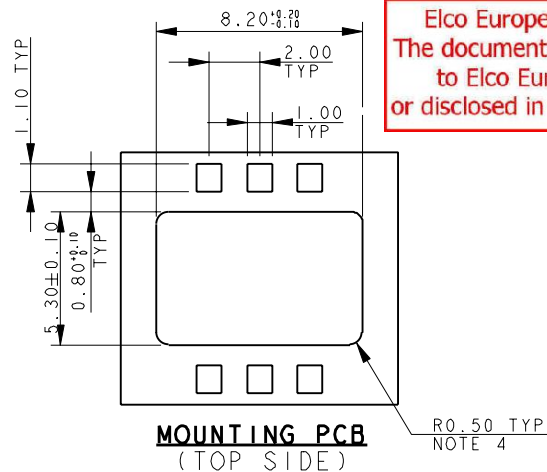
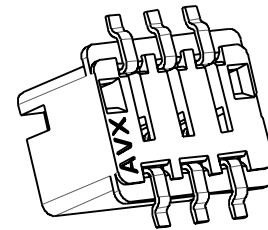
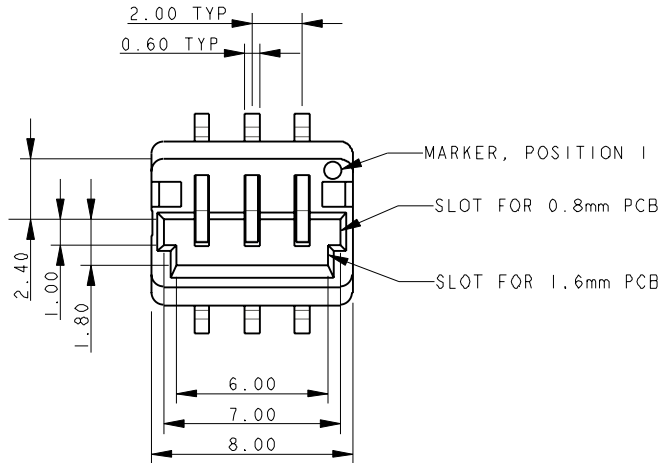

Elco Europe (A Division of AVX Ltd) CONFIDENTIAL PROPRIETY  
The document on this print and information therewith are PROPRIETY to Elco Europe (A Division of AVX Ltd) and shall not be copied or disclosed in whole or in part without Elco Europe's written consent.

**PACKING DETAILS**

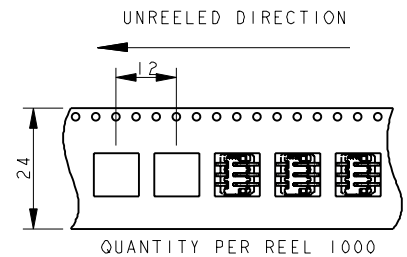
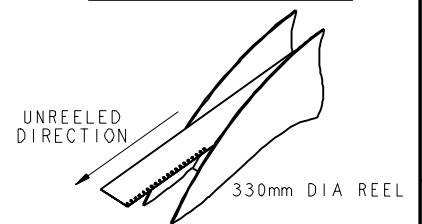

- NOTES :-
1. THROUGH THE BOARD 3 WAY EDGE CARD CONNECTOR.
  2. FOR FURTHER DETAILS REFER TO PRODUCT SPECIFICATION 201-01-136.
  3. FOR MATING PCB EITHER 0.8mm OR 1.6mm THICK. REFER TO SHEET 7 FOR MATING PCB DETAILS.
  4. CONNECTOR TOP MOUNTING ON PCB.
  5. UP TO 0.5mm RAD TO MATCH CONNECTOR PROFILE.
  6. ALL DIMENSIONS ±0.20 UNLESS TOLERANCE SPECIFIED.
  7. INSULATOR :- PA4T, GLASS FILLED, HALOGEN FREE, UL94 V-0, COLOUR REFER TO SHEET 1.
  8. CONTACT :- COPPER ALLOY, NICKEL PLATED WITH GOLD FLASH ON NOSE AND TIN ON TAILS.
  9. BRACKET :- COPPER ALLOY, PLATING, TIN OVER NICKEL.
  10. PACKING IN TAPE AND REEL, 1000 PIECES PER REEL.
  11. CONTACT TAILS COPLANARITY WITHIN 0.10.
  12. REFER TO SHEET 10 FOR MATCHING PROTECTING CAP.
  13. UL REFERENCE E90723.

ELCO EUROPE (A DIVISION OF AVX LTD.) CONFIDENTIAL PROPRIETARY  
THE DRAWING ON THIS PRINT AND INFORMATION THEREWITH ARE PROPRIETARY TO ELCO EUROPE (A DIVISION OF AVX LTD.) AND SHALL NOT BE USED OR DISCLOSED IN WHOLE OR IN PART WITHOUT ELCO EUROPE'S WRITTEN CONSENT.

Release No.	History
102809	10.11.2011
	06.01.2012
	12.01.2012
	03.02.2012
	08.02.2012
	08.03.2012
	28.03.2012
	102876
	26.04.2012
	102879
	14.03.2012
	15.03.2012
	26.06.2012
	24.07.2012

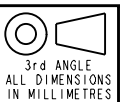

Drawn	N.C.H.	Description	9159 THROUGH BOARD - ORDERING CODE	DATE	06-Jan-12
Size	CV	Part Number	00-9159-01_500S	Issue	6

SHEET 3 OF 10

FORM-106-01-056-6 ISS 7



**THROUGH THE BOARD MATING EDGE CARD CONNECTOR - 4 WAY**

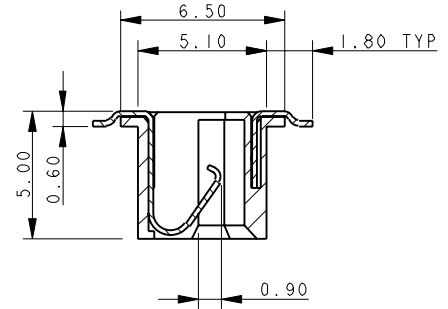
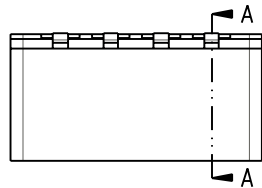

**SECTION A-A**

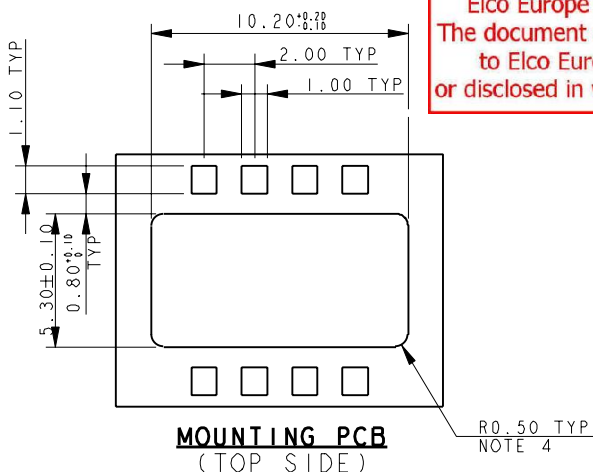
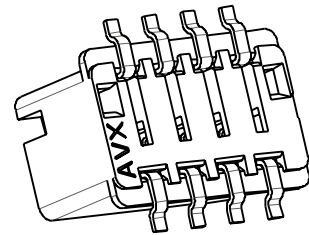
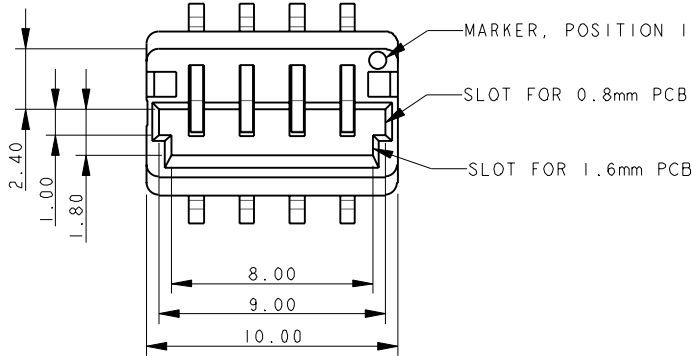

Elco Europe (A Division of AVX Ltd) CONFIDENTIAL PROPRIETY  
The document on this print and information therewith are PROPRIETY  
to Elco Europe (A Division of AVX Ltd) and shall not be copied  
or disclosed in whole or in part without Elco Europe's written consent.

**PACKING DETAILS**

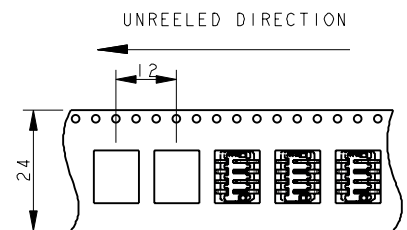
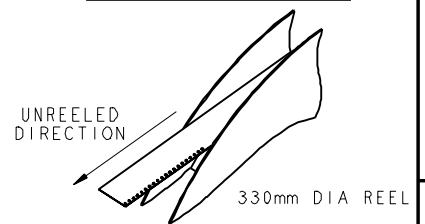

**NOTES :-**

1. THROUGH THE BOARD 4 WAY EDGE CARD CONNECTOR.
2. FOR FURTHER DETAILS REFER TO PRODUCT SPECIFICATION 201-01-136.
3. FOR MATING PCB EITHER 0.8mm OR 1.6mm THICK. REFER TO SHEET 7 FOR MATING PCB DETAILS.
4. CONNECTOR TOP MOUNTING ON PCB.
5. UP TO 0.5mm RAD TO MATCH CONNECTOR PROFILE.
6. ALL DIMENSIONS ±0.20 UNLESS TOLERANCE SPECIFIED.
7. INSULATOR :- PA4T, GLASS FILLED, HALOGEN FREE, UL94 V-0, COLOUR REFER TO SHEET 1.
8. CONTACT :- COPPER ALLOY, NICKEL PLATED WITH GOLD FLASH ON NOSE AND TIN ON TAILS.
9. BRACKET :- COPPER ALLOY, PLATING, TIN OVER NICKEL.
10. PACKING IN TAPE AND REEL, 1000 PIECES PER REEL.
11. CONTACT TAILS COPLANARITY WITHIN 0.10.
12. REFER TO SHEET 10 FOR MATCHING PROTECTING CAP.
13. UL REFERENCE E90723.

ELCO EUROPE (A DIVISION OF AVX LTD.) CONFIDENTIAL PROPRIETARY  
THE DRAWING ON THIS PRINT AND INFORMATION THEREWITH ARE PROPRIETARY TO ELCO EUROPE (A DIVISION OF AVX LTD.) AND SHALL NOT BE USED OR DISCLOSED IN WHOLE OR IN PART WITHOUT ELCO EUROPE'S WRITTEN CONSENT.

Release No.	History
102809	10.11.2011
102810	06.01.2012
102811	12.01.2012
102812	03.02.2012
102813	08.02.2012
102814	08.03.2012
102815	28.03.2012
102816	26.04.2012
102817	14.05.2012
102818	15.05.2012
102819	26.06.2012
102820	24.07.2012

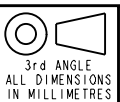

Drawn	N.C.H.	Description	6159 THROUGH BOARD - ORDERING CODE	DATE	06-Jan-12
Size	CV	Part Number	00-9159-01_500S	Issue	6

SHEET 4 OF 10

FORM-106-01-056-6 ISS 7



**THROUGH THE BOARD MATING EDGE CARD CONNECTOR - 5 WAY**

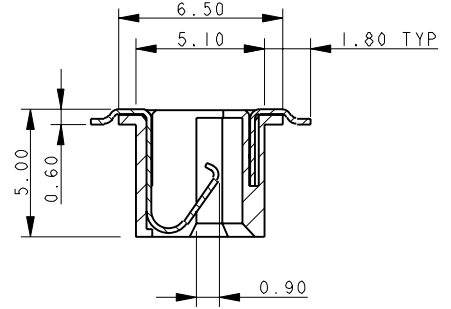
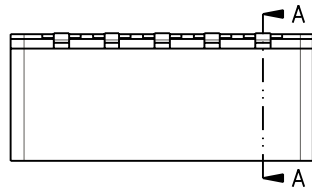

**SECTION A-A**

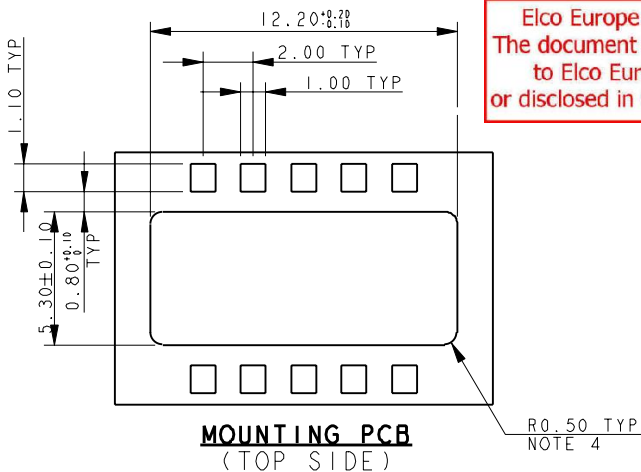
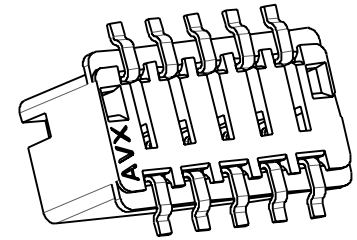
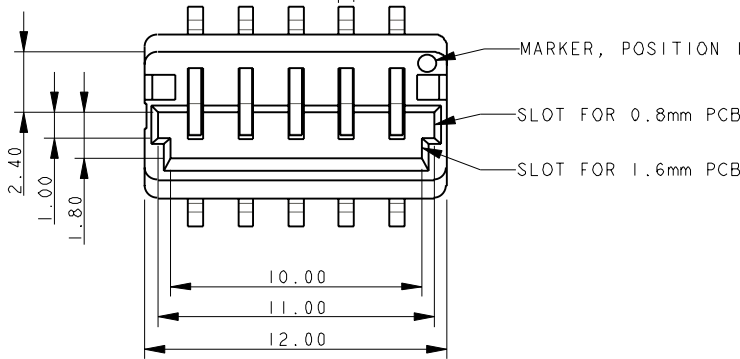

Elco Europe (A Division of AVX Ltd) CONFIDENTIAL PROPRIETY  
The document on this print and information therewith are PROPRIETY  
to Elco Europe (A Division of AVX Ltd) and shall not be copied  
or disclosed in whole or in part without Elco Europe's written consent.

**PACKING DETAILS**

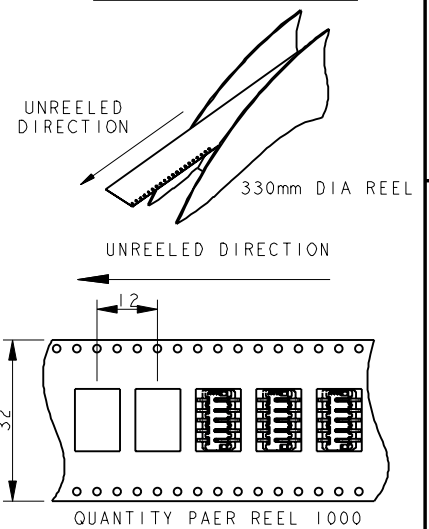

**NOTES :-**

1. THROUGH THE BOARD 5 WAY EDGE CARD CONNECTOR. FOR FURTHER DETAILS REFER TO PRODUCT SPECIFICATION 201-01-136.
2. FOR MATING PCB EITHER 0.8mm OR 1.6mm THICK. REFER TO SHEET 7 FOR MATING PCB DETAILS.
3. CONNECTOR TOP MOUNTING ON PCB.
4. UP TO 0.5mm RAD TO MATCH CONNECTOR PROFILE.
5. ALL DIMENSIONS ±0.20 UNLESS TOLERANCE SPECIFIED.
6. INSULATOR :- PA4T, GLASS FILLED, HALOGEN FREE, UL94 V-0, COLOUR REFER TO SHEET 1.
7. CONTACT :- COPPER ALLOY, NICKEL PLATED WITH GOLD FLASH ON NOSE AND TIN ON TAILS.
8. BRACKET :- COPPER ALLOY, PLATING, TIN OVER NICKEL.
9. PACKING IN TAPE AND REEL, 1000 PIECES PER REEL.
10. CONTACT TAILS COPLANARITY WITHIN 0.10.
11. REFER TO SHEET 10 FOR MATCHING PROTECTING CAP.
12. UL REFERENCE E90723.

ELCO EUROPE (A DIVISION OF AVX LTD.) CONFIDENTIAL PROPRIETY  
THE DRAWING ON THIS PRINT AND INFORMATION THEREWITH ARE PROPRIETARY TO ELCO EUROPE (A DIVISION OF AVX LTD.) AND SHALL NOT BE USED OR DISCLOSED IN WHOLE OR IN PART WITHOUT ELCO EUROPE'S WRITTEN CONSENT.

Release No.	102809
History	10.11.2011
	06.01.2012
	12.01.2012
	03.02.2012
	08.02.2012
	08.03.2012
	28.03.2012
	102876
	26.04.2012
	102879
	14.03.2012
	15.03.2012
	26.06.2012
	24.07.2012

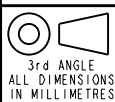

Drawn	N.C.H.	Description	9159 THROUGH BOARD - ORDERING CODE	DATE	06-Jan-12
Size	CV	Part Number	00-9159-01_500S	Issue	6

FORM-106-01-056-6 ISS 7



**THROUGH THE BOARD MATING EDGE CARD CONNECTOR - 6 WAY**

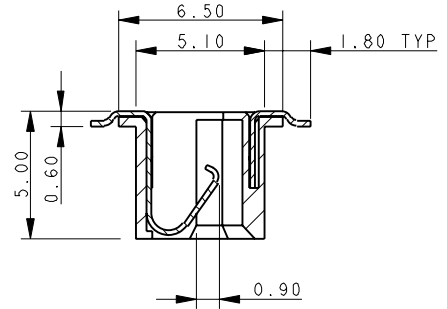
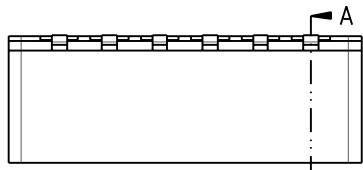

**SECTION A-A**

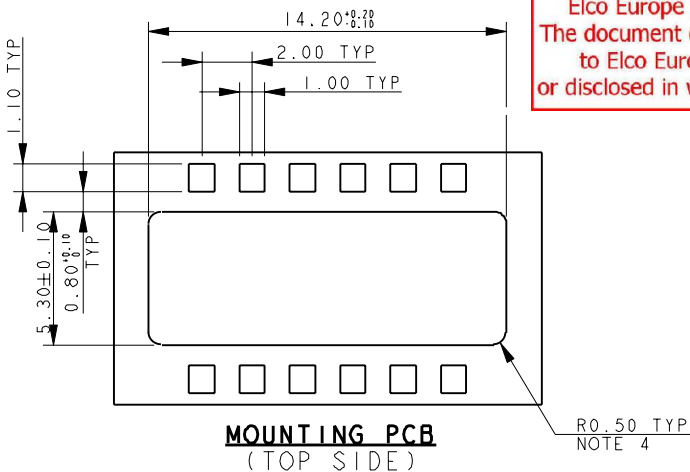
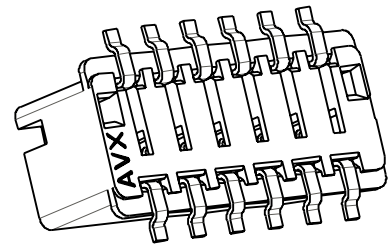
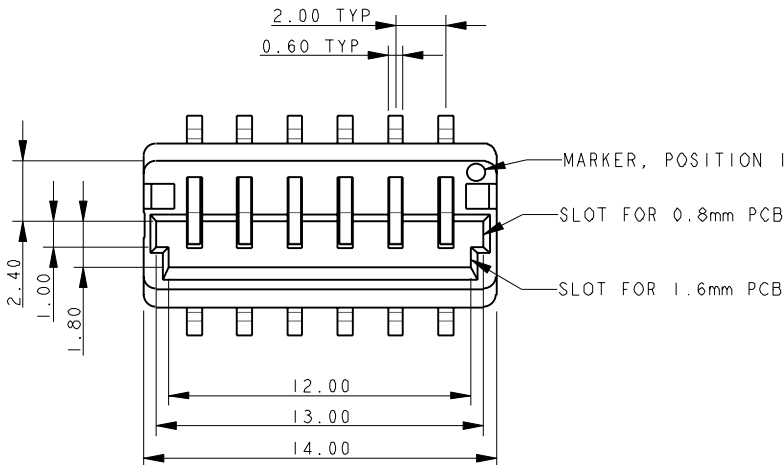

Elco Europe (A Division of AVX Ltd) CONFIDENTIAL PROPRIETY  
The document on this print and information therewith are PROPRIETY  
to Elco Europe (A Division of AVX Ltd) and shall not be copied  
or disclosed in whole or in part without Elco Europe's written consent.

**PACKING DETAILS**

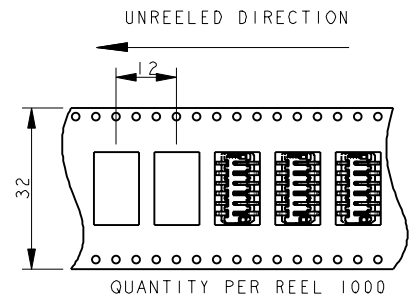
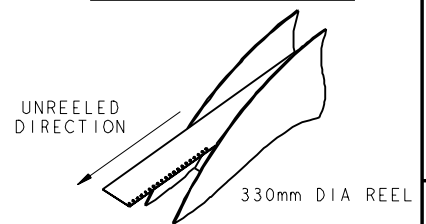

**NOTES :-**

1. THROUGH THE BOARD 6 WAY EDGE CARD CONNECTOR.
2. FOR FURTHER DETAILS REFER TO PRODUCT SPECIFICATION 201-01-136.
3. FOR MATING PCB EITHER 0.8mm OR 1.6mm THICK. REFER TO SHEET 7 FOR MATING PCB DETAILS.
4. CONNECTOR TOP MOUNTING ON PCB.
5. UP TO 0.5mm RAD TO MATCH CONNECTOR PROFILE.
6. ALL DIMENSIONS ±0.20 UNLESS TOLERANCE SPECIFIED.
7. INSULATOR :- PA4T, GLASS FILLED, HALOGEN FREE, UL94 V-0, COLOUR REFER TO SHEET 1.
8. CONTACT :- COPPER ALLOY, NICKEL PLATED WITH GOLD FLASH ON NOSE AND TIN ON TAILS.
9. BRACKET :- COPPER ALLOY, PLATING, TIN OVER NICKEL.
10. PACKING IN TAPE AND REEL, 1000 PICES PER REEL.
11. CONTACT TAILS COPLANARITY WITHIN 0.10.
12. REFER TO SHEET 10 FOR MATCHING PROTECTING CAP.
13. UL REFERENCE E90723.

ELCO EUROPE (A DIVISION OF AVX LTD.) CONFIDENTIAL PROPRIETARY  
THE DRAWING ON THIS PRINT AND INFORMATION THEREWITH ARE PROPRIETARY TO ELCO EUROPE (A DIVISION OF AVX LTD.) AND SHALL NOT BE USED OR DISCLOSED IN WHOLE OR IN PART WITHOUT ELCO EUROPE'S WRITTEN CONSENT.

Release No.	102809
History	10.11.2011
	06.01.2012
	12.01.2012
	08.02.2012
	08.03.2012
	28.03.2012
	26.04.2012
	102879
	14.03.2012
	15.06.2012
	26.06.2012
	24.07.2012

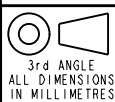

Drawn	N.C.H.	Description	9159 THROUGH BOARD - ORDERING CODE	DATE	06-Jan-12
Size	CV	Part Number	00-9159-01_500S	Issue	6

SHEET 6 OF 10

FORM-106-01-056-6 ISS 7

**THROUGH THE BOARD MATING EDGE CARD CONNECTOR - WITH CAP**  
**00-9159-00X-502-X06**

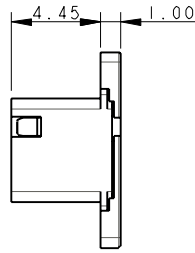
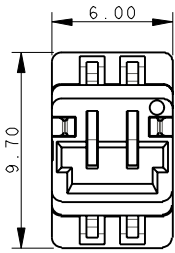

**00-9159-002-502-906**

Elco Europe (A Division of AVX Ltd) CONFIDENTIAL PROPRIETY  
 The document on this print and information therewith are PROPRIETY  
 to Elco Europe (A Division of AVX Ltd) and shall not be copied  
 or disclosed in whole or in part without Elco Europe's written consent.

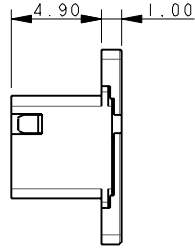
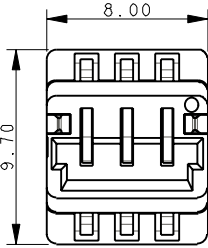

**00-9159-003-502-906**

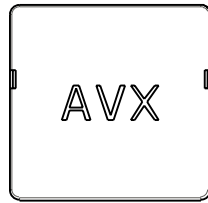
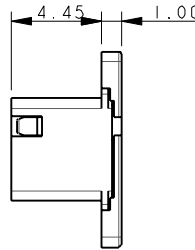
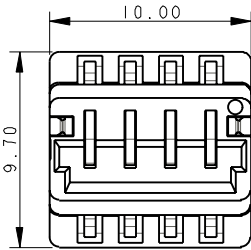

**00-9159-004-502-906**

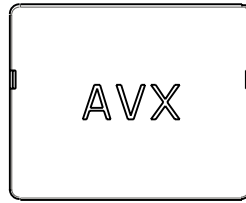
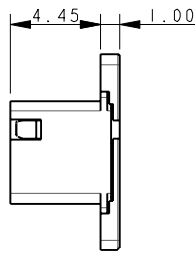
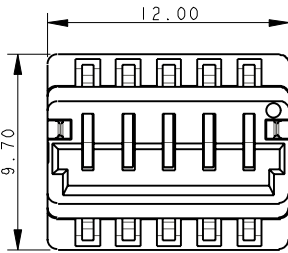

**00-9159-005-502-906**

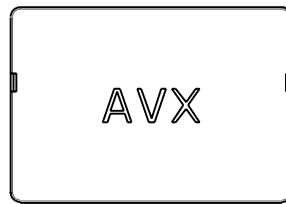
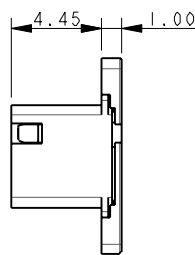
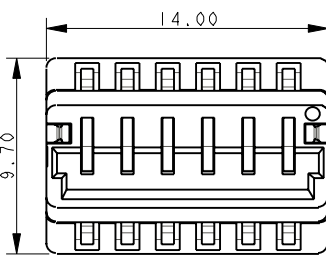

**00-9159-006-502-906**

- NOTES :-
1. 00-9159-00X-501-X06 WITH CAP SUPPLIED FITTED.
  2. DRAWINGS SHOW OUTLINE DIMENSIONS OF THE 00-9159-00X-502-X06 ASSEMBLIES, ALL OTHER DETAILS ARE AS 00-9159-00X-501-X06 ON SHEETS 2 TO 6.
  3. GENERAL TOLERANCE  $\pm 0.20$ .
  4. PACKING ORIENTATION.
  12. UL REFERENCE E90723.

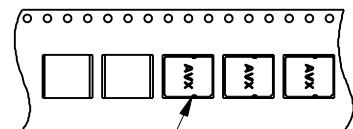

NOTE 4

ELCO EUROPE (A DIVISION OF AVX LTD.) CONFIDENTIAL PROPRIETARY  
 THE DRAWING ON THIS PRINT AND INFORMATION THEREWITH ARE  
 PROPRIETARY TO ELCO EUROPE (A DIVISION OF AVX LTD.) AND  
 SHALL NOT BE USED OR DISCLOSED IN WHOLE OR IN PART  
 WITHOUT ELCO EUROPE'S WRITTEN CONSENT.

SHEET 7 OF 10

Release No.	102809
History	03.02.2012
	08.02.2012
	28.03.2012
	102876
	26.04.2012
	102879
	14.05.2012
	15.06.2012
	26.06.2012
	24.07.2012

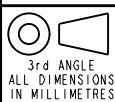

Drawn  
N.C.H.

Size  
CV

Description  
9159 THROUGH BOARD - ORDERING CODE

Part Number  
00-9159-01\_500S

DATE  
06-Jan-12

Issue  
6

THROUGH THE BOARD MATING EDGE CARD CONNECTOR - MATING PCB

MATING PCB - 0.8mm PCB

MATING PCB - 1.6mm PCB

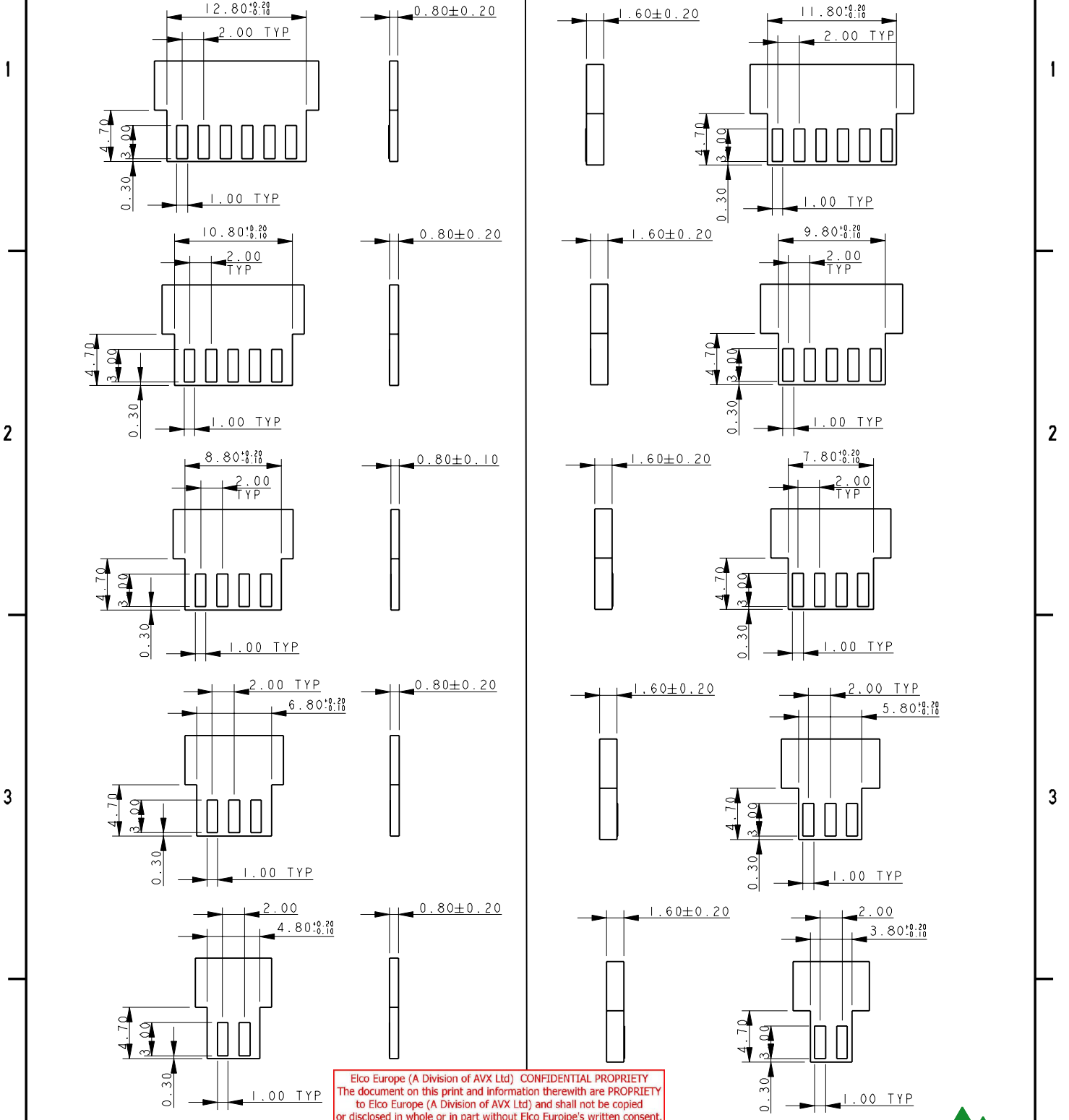

Elco Europe (A Division of AVX Ltd) CONFIDENTIAL PROPRIETY  
 The document on this print and information therewith are PROPRIETY  
 to Elco Europe (A Division of AVX Ltd) and shall not be copied  
 or disclosed in whole or in part without Elco Europe's written consent.

- NOTES :-
1. CORRECT DIMENSIONS FOR EITHER 0.80mm OR 1.60mm PCB THICKNESS MUST BE USED.
  2. THICKNESS OF PCB INCLUDES ALL LAYERS INCLUDING COPPER AND PLATING.
  3. PADS TO BE PLATED GOLD OVER NICKEL UNDERCOAT.
  4. GENERAL TOLERANCE ±0.10 UNLESS STATED.



ELCO EUROPE (A DIVISION OF AVX LTD.) CONFIDENTIAL PROPRIETY  
 THE DRAWING ON THIS PRINT AND INFORMATION THEREWITH ARE PROPRIETY TO ELCO EUROPE (A DIVISION OF AVX LTD.) AND SHALL NOT BE USED OR DISCLOSED IN WHOLE OR IN PART WITHOUT ELCO EUROPE'S WRITTEN CONSENT.

Release No.
102809
10.11.2011
06.01.2012
12.01.2012
03.02.2012
08.02.2012
28.03.2012
102876
26.04.2012
102879
14.03.2012
15.03.2012
26.06.2012
24.07.2012

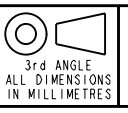

Drawn N.C.H.	Description 9159 THROUGH BOARD - ORDERING CODE	DATE 06-Jan-12
Size CV	Part Number 00-9159-01_500S	Issue 6

SHEET 8 OF 10

A

B

FORM-106-01-056-6 ISS 7





**THROUGH THE BOARD MATING EDGE CARD CONNECTOR**

**Elco Europe (A Division of AVX Ltd) CONFIDENTIAL PROPRIETY**  
**The document on this print and information therewith are PROPRIETY**  
**to Elco Europe (A Division of AVX Ltd) and shall not be copied**  
**or disclosed in whole or in part without Elco Europe's written consent.**

**CONNECTOR/PCB ASSEMBLY**  
**0.8mm MATING PCB**  
**NO CAP**

**CONNECTOR/PCB ASSEMBLY**  
**1.6mm MATING PCB**  
**WITH CAP**

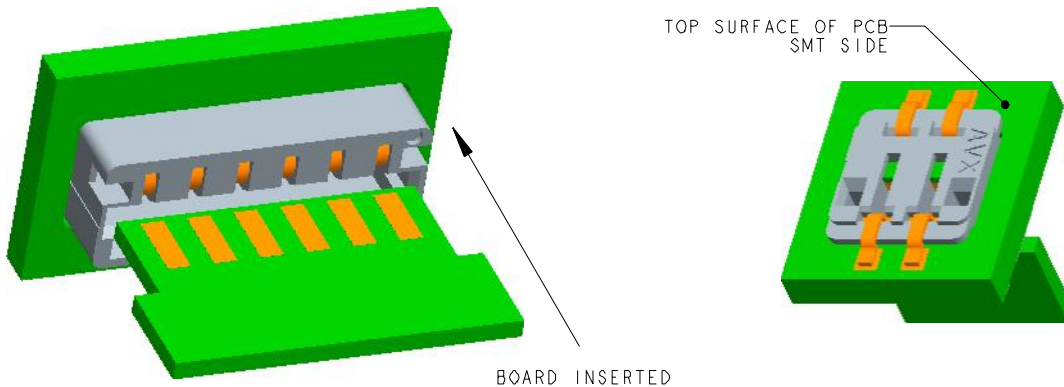
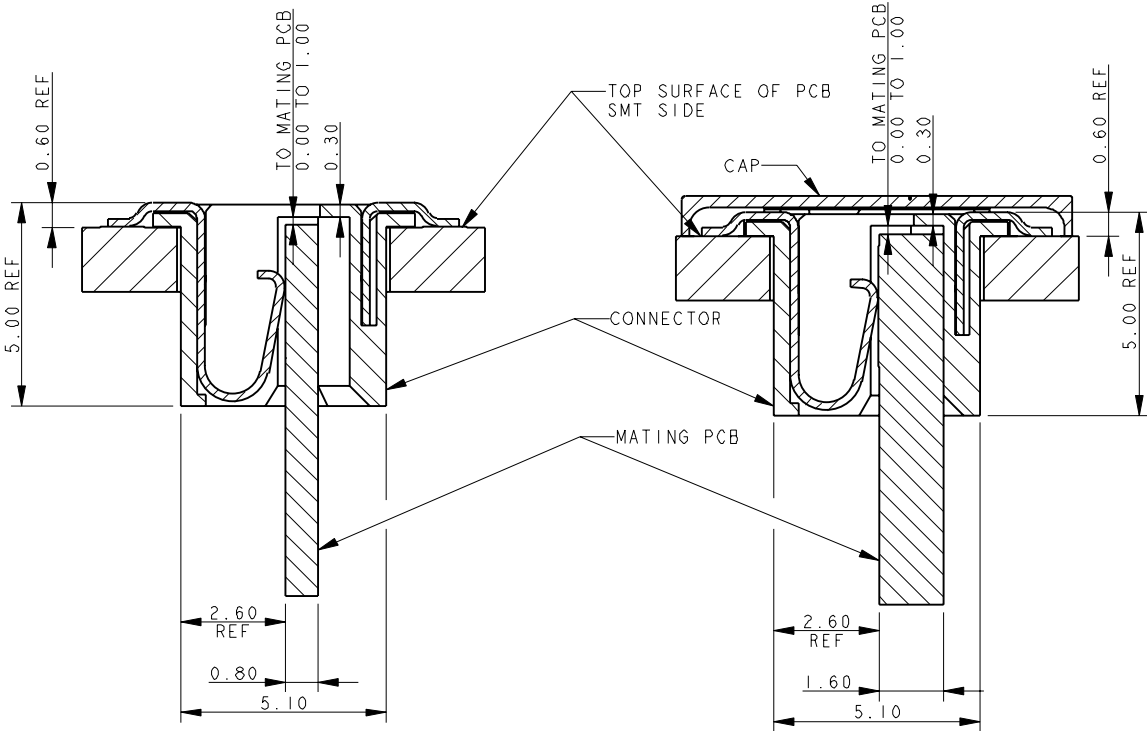

**NOTES :-**

1. THROUGH THE BOARD EDGE CARD CONNECTOR.
2. FOR MATING PCB EITHER 0.8mm OR 1.6mm THICK. REFER TO SHEET 7 FOR MATING PCB DETAILS.
3. CONNECTOR TOP MOUNTING ON PCB.
4. PAD DETAILS ON THE MATING PCB ALLOW CONTACT TO BE MADE IN ANY POSITION FROM THE STOP FACE UP TO 1mm FROM THE STOP FACE.
5. GENERAL TOLERANCE  $\pm 0.20$  UNLESS STATED.

ELCO EUROPE (A DIVISION OF AVX LTD.) CONFIDENTIAL PROPRIETY  
 THE DRAWING ON THIS PRINT AND INFORMATION THEREWITH ARE  
 PROPRIETARY TO ELCO EUROPE (A DIVISION OF AVX LTD.) AND  
 SHALL NOT BE USED OR DISCLOSED IN WHOLE OR IN PART  
 WITHOUT ELCO EUROPE'S WRITTEN CONSENT.

SHEET 9 OF 10

Release No.	102809
History	10.11.2011
	06.01.2012
	12.01.2012
	03.02.2012
	08.02.2012
	28.03.2012
	102876
	26.04.2012
	102879
	14.05.2012
	26.06.2012
	24.07.2012

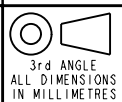

Drawn	N.C.H.
Size	CV

Description	9159 THROUGH BOARD - ORDERING CODE
Part Number	00-9159-01_500S

DATE	06-Jan-12
Issue	6

A

B



**ACCESSORY - PROTECTING CAP**

Elco Europe (A Division of AVX Ltd) CONFIDENTIAL PROPRIETY  
 The document on this print and information therewith are PROPRIETY  
 to Elco Europe (A Division of AVX Ltd) and shall not be copied  
 or disclosed in whole or in part without Elco Europe's written consent.

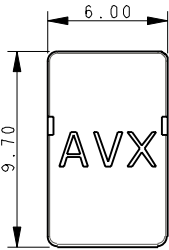

2 WAY  
 60-9159-3502-09-000

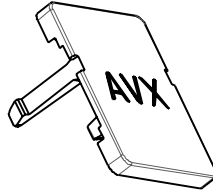
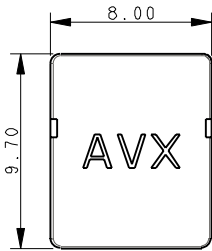

3 WAY  
 60-9159-3503-09-000

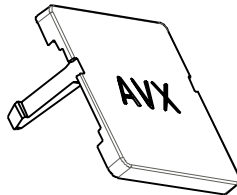
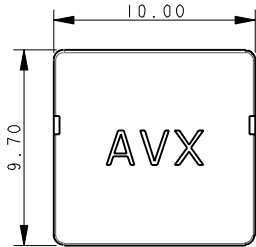

4 WAY  
 60-9159-3504-09-000

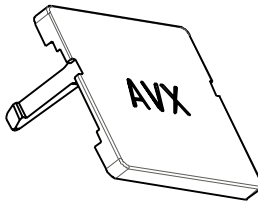
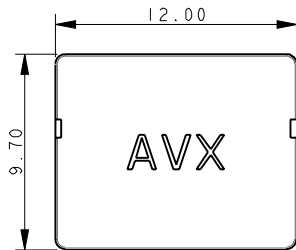

5 WAY  
 60-9159-350-09-000

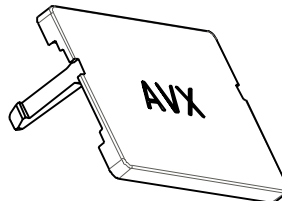
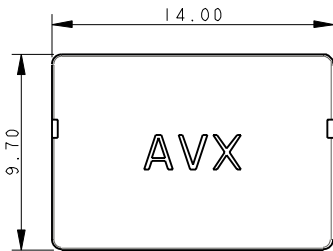

6 WAY  
 60-9159-3506-09-000

- NOTES :-  
 1. PROTECTING CAP, ACCESSORY, NOT SUPPLIED WITH CONNECTOR.  
 2. CLIPS TO TOP OF CONNECTOR TO COVER ALL METAL COMPONENTS.  
 3. MATERIAL :- PA4T, GLASS FILLED, HALOGEN FREE, UL94 V-0,  
 COLOUR CODE REFER TO SHEET 1, "X" IN PART NUMBER.  
 4. SUPPLIED IN BAGS OF 1000 PIECES.  
 5. GENERAL TOLERANCE  $\pm 0.20$ .  
 12. UL REFERENCE E90723.

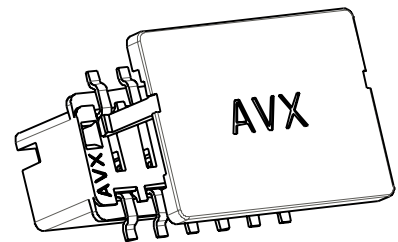
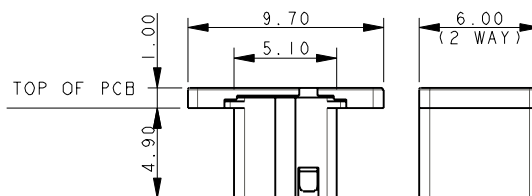

**ASSEMBLED CAP**

ELCO EUROPE (A DIVISION OF AVX LTD.) CONFIDENTIAL PROPRIETY  
 THE DRAWING ON THIS PRINT AND INFORMATION THEREWITH ARE  
 PROPRIETARY TO ELCO EUROPE (A DIVISION OF AVX LTD.) AND  
 SHALL NOT BE USED OR DISCLOSED IN WHOLE OR IN PART  
 WITHOUT ELCO EUROPE'S WRITTEN CONSENT.

SHEET 10 OF 10

Release No.	History
102809	10.11.2011
	06.01.2012
	12.01.2012
	03.02.2012
	08.02.2012
	08.03.2012
	28.03.2012
	102876
	26.04.2012
	102879
	14.03.2012
	15.03.2012
	26.06.2012
	24.07.2012

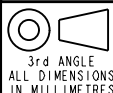

Drawn  
 N.C.H.  
 Size  
 CV

Description  
 9159 THROUGH BOARD - ORDERING CODE  
 Part Number  
 00-9159-01\_500S

DATE  
 06-Jan-12  
 Issue  
 6

A

B

## Данный компонент на территории Российской Федерации

### Вы можете приобрести в компании MosChip.

Для оперативного оформления запроса Вам необходимо перейти по данной ссылке:

<http://moschip.ru/get-element>

Вы можете разместить у нас заказ для любого Вашего проекта, будь то серийное производство или разработка единичного прибора.

В нашем ассортименте представлены ведущие мировые производители активных и пассивных электронных компонентов.

Нашей специализацией является поставка электронной компонентной базы двойного назначения, продукции таких производителей как XILINX, Intel (ex.ALTERA), Vicor, Microchip, Texas Instruments, Analog Devices, Mini-Circuits, Amphenol, Glenair.

Сотрудничество с глобальными дистрибьюторами электронных компонентов, предоставляет возможность заказывать и получать с международных складов практически любой перечень компонентов в оптимальные для Вас сроки.

На всех этапах разработки и производства наши партнеры могут получить квалифицированную поддержку опытных инженеров.

Система менеджмента качества компании отвечает требованиям в соответствии с ГОСТ Р ИСО 9001, ГОСТ РВ 0015-002 и ЭС РД 009

### Офис по работе с юридическими лицами:

105318, г.Москва, ул.Щербаковская д.3, офис 1107, 1118, ДЦ «Щербаковский»

Телефон: +7 495 668-12-70 (многоканальный)

Факс: +7 495 668-12-70 (доб.304)

E-mail: [info@moschip.ru](mailto:info@moschip.ru)

Skype отдела продаж:

moschip.ru

moschip.ru\_4

moschip.ru\_6

moschip.ru\_9