

Posistor® For Circuit Protection

1. Part Numbering (Part Number)

PT	GL	14	AR	R15	M	1B51	B0
Product ID	Series	Dimensions	Temperature Characteristics	Resistance	Resistance Tolerance	Individual Specifications	Packaging

2. Ratings

Bulk Part Number	Max. Voltage	*1 Resistance Value at +25°C	*2 Maximum Current	*3 Hold Current			*4 Trip Current		Dimensions (mm)	
				+60°C	+25°C	-10°C	D	H		
PTGL14ARR15M1B51B0	D.C. 16V	0.15ohm±20%	10.0A	1200mA	1545mA	2855mA	3360mA	13.5	18.5	
PTGL12AR0R2M1B51B0		0.20ohm±20%	9.0A	1000mA	1300mA	2410mA	2800mA	11.3	16.0	
PTGL12AR0R2M1B51A0		0.27ohm±20%	8.0A	800mA	1025mA	1900mA	2250mA	10.1	15.0	
PTGL10ARR27M1B51B0										
PTGL10ARR27M1B51A0		0.33ohm±20%	7.0A	680mA	875mA	1625mA	1900mA	9.0	14.0	
PTGL09ARR33M1B51B0		0.47ohm±20%	5.0A	560mA	705mA	1310mA	1570mA	7.5	12.0	
PTGL07ARR47M1B51B0										
PTGL07ARR47M1B51A0		0.80ohm±20%	3.0A	400mA	505mA	955mA	1120mA	6.5	10.0	
PTGL06AR0R8M1B51B0										
PTGL06AR0R8M1B51A0		1.00ohm±20%	2.0A	370mA	470mA	880mA	1040mA	6.0	9.5	
PTGL05AR1R0M1B51B0										
PTGL05AR1R0M1B51A0										

- *1 The resist. value is measured at a point of max. 2mm from the end of lead crimp.
- *2 Shows the maximum current value which may be repeatedly introduced into Posistor when the circuit runs abnormally.
- *3 Shows the maximum current value which be repeatedly introduced into Posistor when the circuit runs normally at each ambient temperature.
- *4 Shows the minimum current value which flows the circuit when Posistor protects it from over load at each ambient temperature.

3. Dimensions (mm)

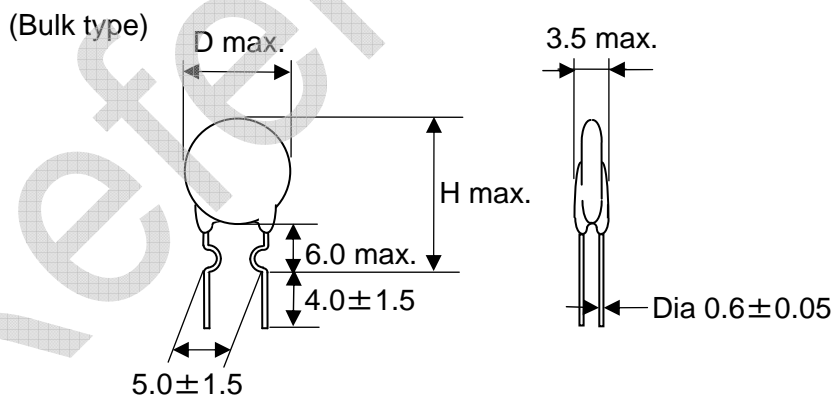

(Taping type : Shown in Taping specification.)

Note)

Some part of resin covering lead wire of Posistor may come off by some outside shock on the root of lead wire, but Posistor can be used normally for electrical and reliability characteristics.

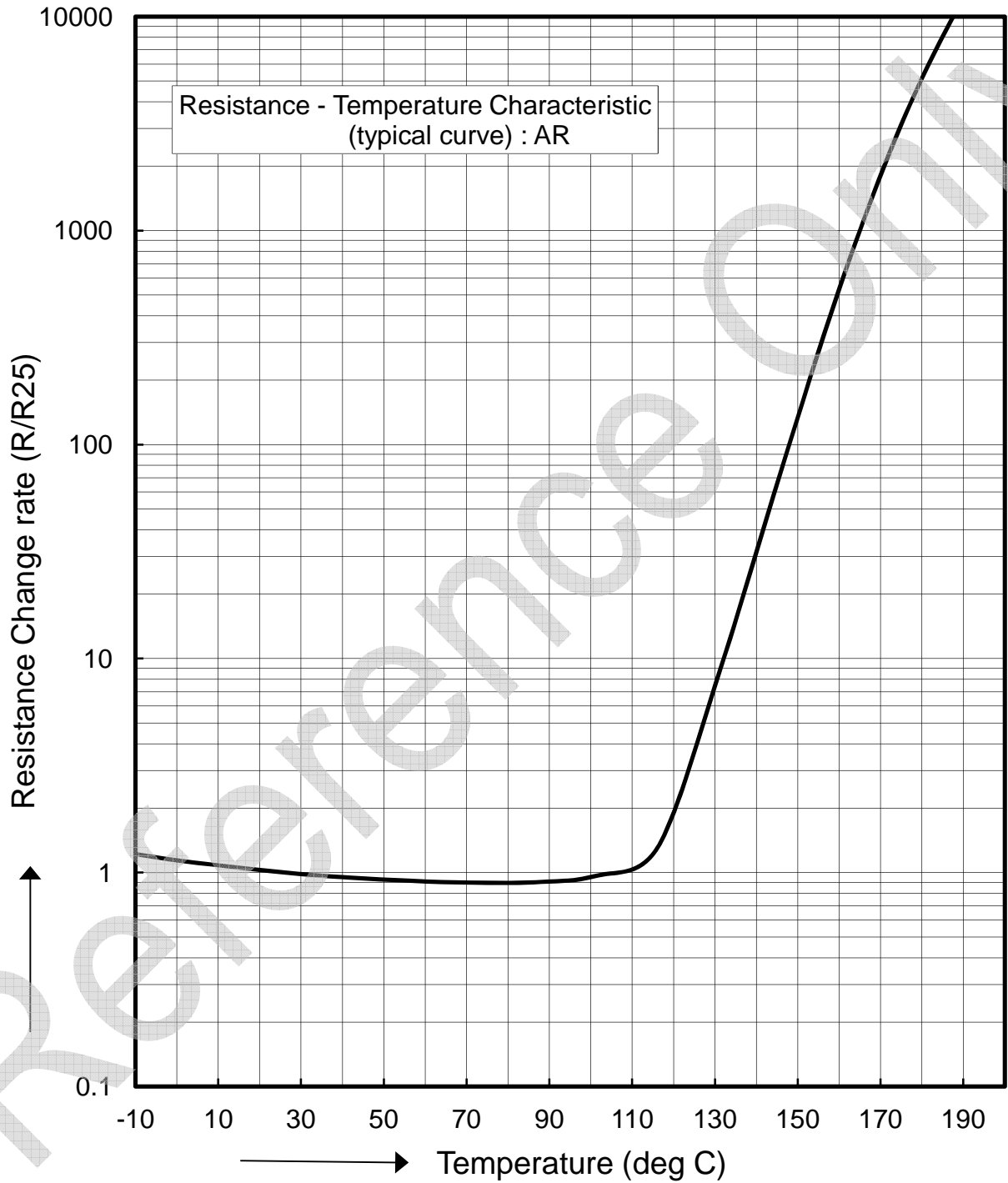

AR-060'

Taping Specification

1. Dimensions of Taping



Item	Code	Dimensions	Note
Pitch of Component	P	12.7	Tolerance is determined by ΔS
Pitch of Sprocket Hole	P0	12.7 ± 0.3	
Lead Spacing	F	$5.0^{+0.8}_{-0.3}$	
Length from Hole Center to Component	P2	6.35 ± 1.3	Deviation in the feeding direction
Length from Hole Center to Lead	P1	3.85 ± 0.8	
Body Diameter	D	Refer to "2.Dimensions"	
Deviation along Tape. Left or Right	ΔS	± 1.5	Including the inclination caused by lead bending.
Carrier Tape Width	W	18.0 ± 0.5	
Position of Sprocket Hole	W1	$9.0^{+0.5}_{-0.75}$	Deviation of tape width.
Lead Distance between Reference and Bottom Planes	H0	16.0 ± 1.0	
	H2	6.0 max.	
Overflow of Lead	l	-1.0 ~ +0.5	
Diameter of Sprocket Hole	D0	4.0 ± 0.2	
Lead Diameter	d	0.6 ± 0.05	
Total Tape Thickness	t1	0.6 ± 0.3	
Total Thickness ,Tape and Lead Wire	t2	2.0 max.	
Deviation across Tape	$\Delta h1, \Delta h2$	1.5 max	
Portion to cut in Case of Defect	L	$11.0^{+0}_{-2.0}$	
Hold Down Tape Width	w0	11.0 min.	
Hold Down Tape Position	w2	4.0 max.	
Coating Extension on Lead	e	Up to the center of crimp	
Body Thickness	T	Refer to "2.Dimensions"	

2. Splicing way of tape

2.1 Cohesive power of tape is over 2.94N at test condition as below figure.

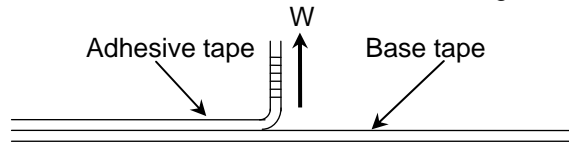
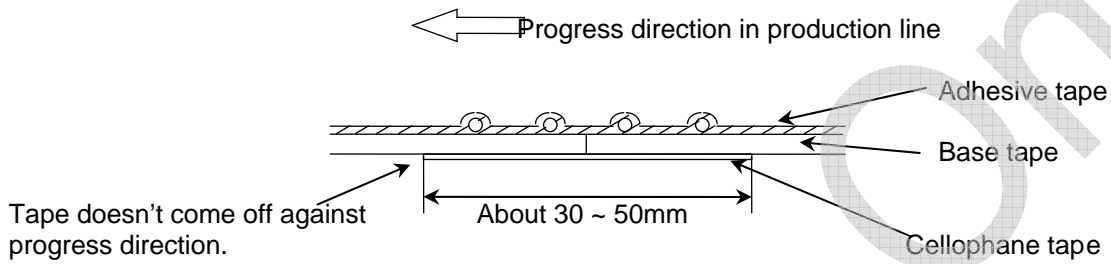

Fig.1

2.2 Splicing of tape

a. When base tape is spliced :



- Base tape shall be spliced by cellophane tape
- Total tape thickness shall be less than 1.05mm

b. When adhesive tape is spliced :

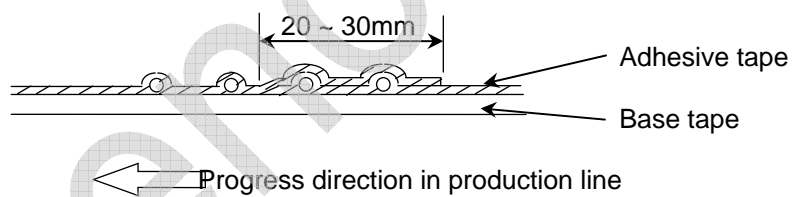

- Adhesive tape shall be spliced with overlapping.
- Total tape thickness shall be less than 1.05mm

c. When both tape are spliced at a time :

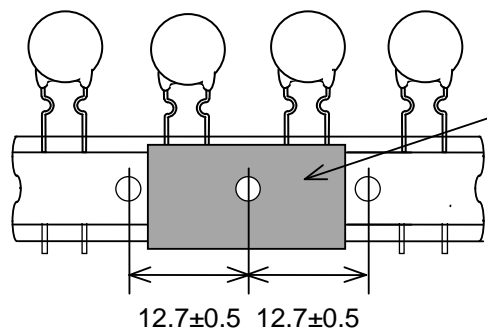

Splicing tape
(Base and adhesive tapes are inserted in a splicing tape.)

(in mm)

2.3 Packing specification (Ammo Pack).

The tape with Posistor is folded each 25 pitches and packed in zigzag into a packing case, when body of Posistor is piled on other body under it. Standard quantity in a case are 2000pcs..

The size of packing case



Packing way

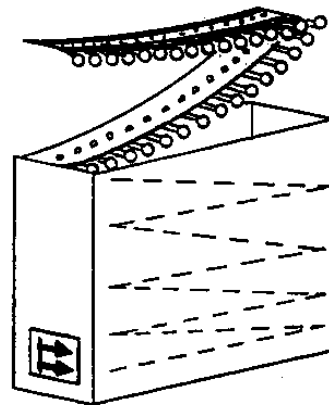
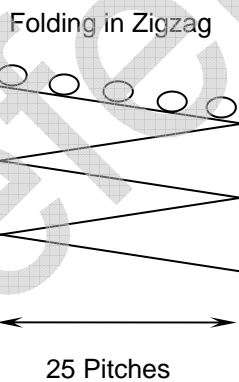

When Posistor 's body is situated on your side, adhesive tape is situated the upside.

Notice for use

 **Caution**

1. This product is designed for application which is used under ordinary environment.(room temperature, normal humidity, normal pressure) Do not expose this to the following environments, because all these factor can deteriorate the characteristic of this and can cause failure or burn out.
 - (1) Corrosive gas or deoxidizing gas (Cl₂, H₂S, NH₃, SO_x, NO_x etc.)
 - (2) Volatile, flammable gas
 - (3) Dusty place
 - (4) Place in a vacuum, reducing or putting pressure
 - (5) Place in splashed water, or high humidity and dewing place
 - (6) Salt water, oil, chemical liquid and solvent
 - (7) Vibratile place
 - (8) Other place equivalent to the above

2. Limitation of Applications
Please contact us before using our products for the under-mentioned applications requiring especially high reliability in order to prevent defects which might directly cause damage to other party's life body or property(listed below).
 - (1)Aircraft equipment (2)Aerospace equipment (3)Undersea equipment (4)Power plant control equipment
 - (5)Medical equipment (6)Transportation equipment(automobiles, trains, ships, etc.)
 - (7)Traffic signal equipment (8)Disaster prevention / Crime prevention equipment
 - (9)Data-processing equipment (10)Applications of similar complexity or with reliability requirements comparable to the applications listed in the above.

3. Be sure to provide an appropriate fail-safe function on your product to prevent a second damage that may be caused by the abnormal function or the failure of our product.

Notice

1. Do not apply abnormal voltage/current exceeding the specified maximum value. Because they may deteriorate or destroy PTC element.
2. Use this product within the specified temperature. A higher temperature may deteriorate the characteristic or material.
3. When this product is operated, temperature of some area may be over 100°C to 160°C. Please make sure that surrounding parts and inserting material can withstand the temperature. If the surrounding part and material is kept under such condition, they may be deteriorated or may produce harmful gas(Cl₂, H₂S, NH₃, SO_x, NO_x etc.). And, such harmful gas may deteriorate the element.
4. The resin coating of this product is not for insulating purpose. Keep an adequate insulating distance to surrounding components.
5. This product does not have waterproof construction. A splashed water may cause failure mode such as deterioration of characteristic or current leak.
So, Do NOT apply cleaning to immerse it into water or any solvent.
6. If you coat this product by resin, please evaluate the quality of this product before you use it.
The stress of force which is caused by coating materials or heat cycles may cause failure mode such as deterioration of characteristic or current leak in worst case.
7. This product is using the solder of 221+/-5 °C of melting points, in order to connect ceramics with a lead wire. Do not heat up a terminal area of this product over 180 °C.
8. The ceramic element of this product is fragile, and care must be taken not to load a excessive pressforce or not to give a shock at handling. Such forces may cause cracking or chipping.

9. Do not apply an excessive force to the lead. Otherwise, it may cause break off the junction between lead and element, or may crack element. Therefore, hold of element side lead wire is recommended when lead wire is bent or cut.
10. When the lead of this product is soldered, pay attention as follows to avoid the decline of element characteristic or break down the element.
 - (1) Use Rosin type flux or non-activated flux(the content of chlorine shall be less than 0.2%)
 - (2) Do not dip the body into flux. (Flux shall be coated to lead wire only for soldering.)
 - (3) The pre-heat up should be conducted without melting the soldering of this product.
11. Do not apply tensile force or separating force to lead wire at soldering.
12. Do not touch the resin case by soldering iron. The soldering point shall be min. 5 mm away from the root of lead wire. Please solder the following conditions.
 - Iron Tip Temperature : 360 degree C max.
 - Soldering Time : 4 seconds max. / 1 terminal
 - Number of Soldering : 1
13. To keep solderability of product from declining, following storage condition is recommended.
 - (1) Storage condition Temperature : -10 to +40°C
Humidity : less than 75%RH(not dewing condition)
 - (2) Term : Please use this product within 6 months after shipment by first-in and first-out stocking system.
 - (3) Handling after unpacking of the minimum package : Reseal it promptly or store it seal open inside a sealed container with a drying agent.
 - (4) Place : Do not store this product in corrosive gas(SO_x,Cl etc) or under sun-light.

Данный компонент на территории Российской Федерации

Вы можете приобрести в компании MosChip.

Для оперативного оформления запроса Вам необходимо перейти по данной ссылке:

<http://moschip.ru/get-element>

Вы можете разместить у нас заказ для любого Вашего проекта, будь то серийное производство или разработка единичного прибора.

В нашем ассортименте представлены ведущие мировые производители активных и пассивных электронных компонентов.

Нашей специализацией является поставка электронной компонентной базы двойного назначения, продукции таких производителей как XILINX, Intel (ex.ALTERA), Vicor, Microchip, Texas Instruments, Analog Devices, Mini-Circuits, Amphenol, Glenair.

Сотрудничество с глобальными дистрибьюторами электронных компонентов, предоставляет возможность заказывать и получать с международных складов практически любой перечень компонентов в оптимальные для Вас сроки.

На всех этапах разработки и производства наши партнеры могут получить квалифицированную поддержку опытных инженеров.

Система менеджмента качества компании отвечает требованиям в соответствии с ГОСТ Р ИСО 9001, ГОСТ РВ 0015-002 и ЭС РД 009

Офис по работе с юридическими лицами:

105318, г.Москва, ул.Щербаковская д.3, офис 1107, 1118, ДЦ «Щербаковский»

Телефон: +7 495 668-12-70 (многоканальный)

Факс: +7 495 668-12-70 (доб.304)

E-mail: info@moschip.ru

Skype отдела продаж:

moschip.ru

moschip.ru_4

moschip.ru_6

moschip.ru_9