

# MJ11015 (PNP); MJ11012, MJ11016 (NPN)

MJ11016 is a Preferred Device

## High-Current Complementary Silicon Transistors

... for use as output devices in complementary general purpose amplifier applications.

- High DC Current Gain –  
 $h_{FE} = 1000$  (Min) @  $I_C = 20$  Adc
- Monolithic Construction with Built-in Base Emitter Shunt Resistor
- Junction Temperature to  $+200^\circ\text{C}$

### MAXIMUM RATINGS

Rating	Symbol	Value	Unit
Collector-Emitter Voltage MJ11012 MJ11015/6	$V_{CEO}$	60 120	Vdc
Collector-Base Voltage MJ11012 MJ11015/6	$V_{CB}$	60 120	Vdc
Emitter-Base Voltage	$V_{EB}$	5	Vdc
Collector Current	$I_C$	30	Adc
Base Current	$I_B$	1	Adc
Total Device Dissipation @ $T_C = 25^\circ\text{C}$ Derate above $25^\circ\text{C}$ @ $T_C = 100^\circ\text{C}$	$P_D$	200 1.15	W W/ $^\circ\text{C}$
Operating Storage Junction Temperature Range	$T_J, T_{stg}$	-55 to +200	$^\circ\text{C}$

### THERMAL CHARACTERISTICS

Characteristic	Symbol	Max	Unit
Thermal Resistance, Junction-to-Case	$R_{\theta JC}$	0.87	$^\circ\text{C}/\text{W}$
Maximum Lead Temperature for Soldering Purposes for $\leq 10$ Seconds	$T_L$	275	$^\circ\text{C}$

Stresses exceeding Maximum Ratings may damage the device. Maximum Ratings are stress ratings only. Functional operation above the Recommended Operating Conditions is not implied. Extended exposure to stresses above the Recommended Operating Conditions may affect device reliability.



ON Semiconductor®

<http://onsemi.com>

## 30 AMPERE DARLINGTON POWER TRANSISTORS COMPLEMENTARY SILICON 60 – 120 VOLTS, 200 WATTS

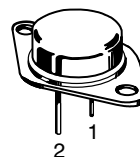
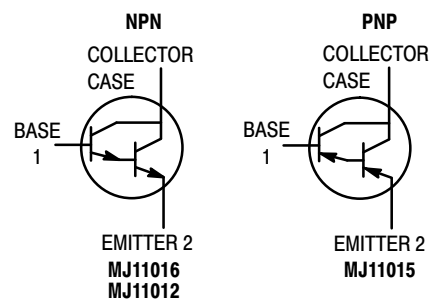

TO-204AA (TO-3)  
CASE 1-07  
STYLE 1

### MARKING DIAGRAM



- MJ1101x = Device Code  
x = 2, 5 or 6  
G = Pb-Free Package  
A = Location Code  
YY = Year  
WW = Work Week  
MEX = Country of Origin

### ORDERING INFORMATION

Device	Package	Shipping
MJ11012	TO-3	100 Units/Tray
MJ11012G	TO-3 (Pb-Free)	100 Units/Tray
MJ11015	TO-3	100 Units/Tray
MJ11015G	TO-3 (Pb-Free)	100 Units/Tray
MJ11016	TO-3	100 Units/Tray
MJ11016G	TO-3 (Pb-Free)	100 Units/Tray

Preferred devices are recommended choices for future use and best overall value.

## MJ11015 (PNP); MJ11012, MJ11016 (NPN)



**Figure 1. Darlingtons Circuit Schematic**

### ELECTRICAL CHARACTERISTICS ( $T_C = 25^\circ\text{C}$ unless otherwise noted.)

Characteristics	Symbol	Min	Max	Unit
<b>OFF CHARACTERISTICS</b>				
Collector–Emitter Breakdown Voltage(1) ( $I_C = 100\text{ mAdc}$ , $I_B = 0$ )	$V_{(BR)CEO}$	60 120	– –	Vdc
Collector–Emitter Leakage Current ( $V_{CE} = 60\text{ Vdc}$ , $R_{BE} = 1\text{ k ohm}$ ) ( $V_{CE} = 120\text{ Vdc}$ , $R_{BE} = 1\text{ k ohm}$ ) ( $V_{CE} = 60\text{ Vdc}$ , $R_{BE} = 1\text{ k ohm}$ , $T_C = 150^\circ\text{C}$ ) ( $V_{CE} = 120\text{ Vdc}$ , $R_{BE} = 1\text{ k ohm}$ , $T_C = 150^\circ\text{C}$ )	$I_{CER}$	– – – –	1 1 5 5	mAdc
Emitter Cutoff Current ( $V_{BE} = 5\text{ Vdc}$ , $I_C = 0$ )	$I_{EBO}$	–	5	mAdc
Collector–Emitter Leakage Current ( $V_{CE} = 50\text{ Vdc}$ , $I_B = 0$ )	$I_{CEO}$	–	1	mAdc
<b>ON CHARACTERISTICS(1)</b>				
DC Current Gain ( $I_C = 20\text{ Adc}$ , $V_{CE} = 5\text{ Vdc}$ ) ( $I_C = 30\text{ Adc}$ , $V_{CE} = 5\text{ Vdc}$ )	$h_{FE}$	1000 200	– –	–
Collector–Emitter Saturation Voltage ( $I_C = 20\text{ Adc}$ , $I_B = 200\text{ mAdc}$ ) ( $I_C = 30\text{ Adc}$ , $I_B = 300\text{ mAdc}$ )	$V_{CE(sat)}$	– –	3 4	Vdc
Base–Emitter Saturation Voltage ( $I_C = 20\text{ A}$ , $I_B = 200\text{ mAdc}$ ) ( $I_C = 30\text{ A}$ , $I_B = 300\text{ mAdc}$ )	$V_{BE(sat)}$	– –	3.5 5	Vdc
<b>DYNAMIC CHARACTERISTICS</b>				
Current–Gain Bandwidth Product ( $I_C = 10\text{ A}$ , $V_{CE} = 3\text{ Vdc}$ , $f = 1\text{ MHz}$ )	$h_{fe}$	4	–	MHz

(1) Pulse Test: Pulse Width = 300  $\mu\text{s}$ , Duty Cycle  $\leq 2.0\%$ .

## MJ11015 (PNP); MJ11012, MJ11016 (NPN)

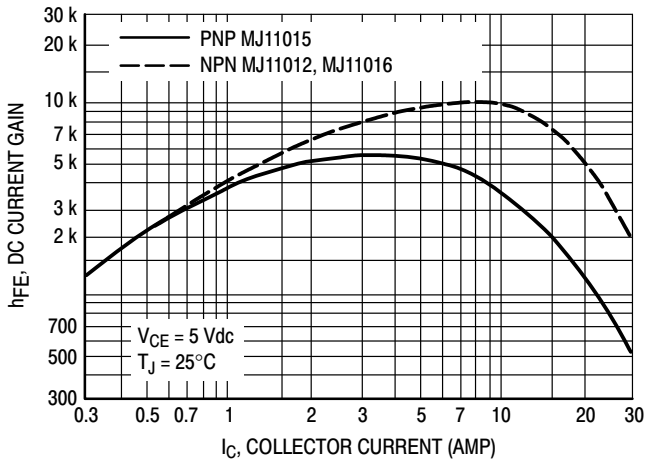

Figure 2. DC Current Gain (1)

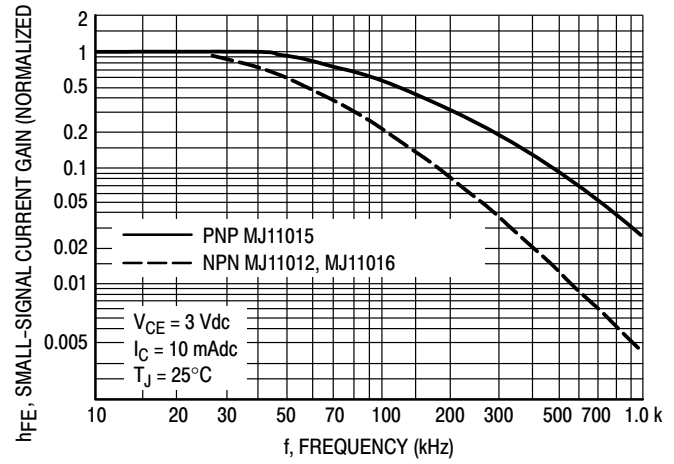

Figure 3. Small-Signal Current Gain

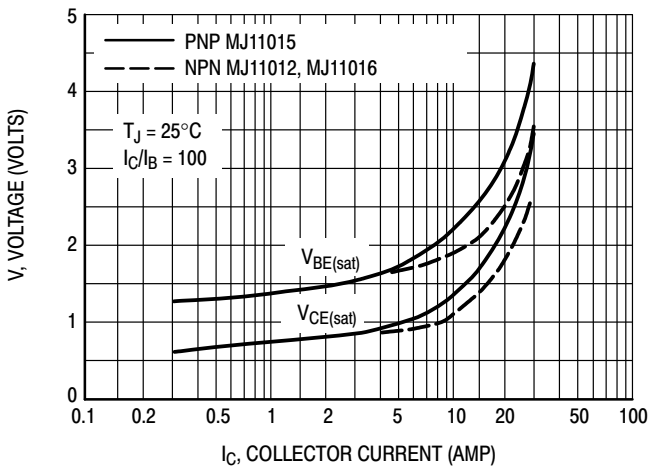

Figure 4. "On" Voltages (1)

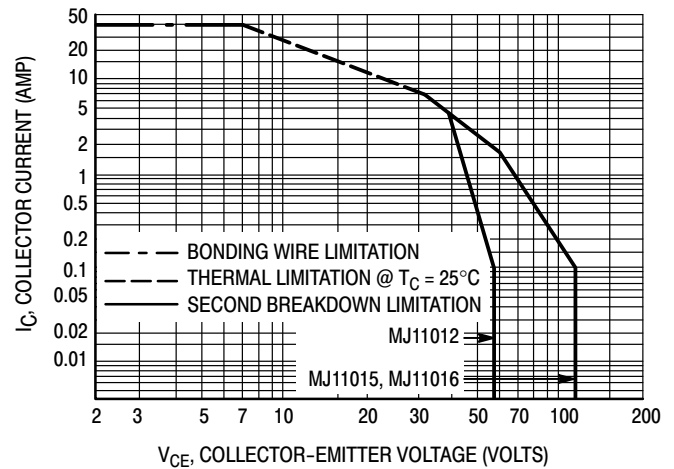

Figure 5. Active Region DC Safe Operating Area

There are two limitations on the power handling ability of a transistor average junction temperature and secondary breakdown. Safe operating area curves indicate  $I_C - V_{CE}$  limits of the transistor that must be observed for reliable operations e.g., the transistor must not be subjected to greater dissipation than the curves indicate.

At high case temperatures, thermal limitations will reduce the power that can be handled to values less than the limitations imposed by secondary breakdown.

# MJ11015 (PNP); MJ11012, MJ11016 (NPN)

## PACKAGE DIMENSIONS

TO-204 (TO-3)  
CASE 1-07  
ISSUE Z

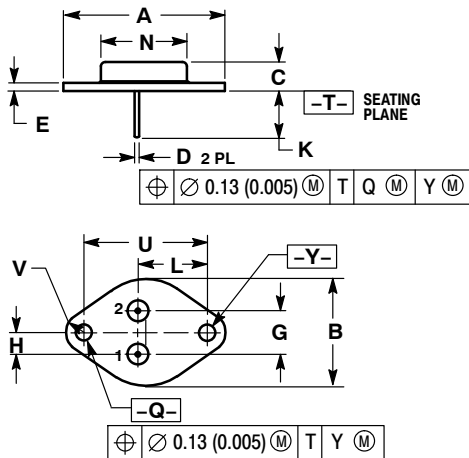

NOTES:

1. DIMENSIONING AND TOLERANCING PER ANSI Y14.5M, 1982.
2. CONTROLLING DIMENSION: INCH.
3. ALL RULES AND NOTES ASSOCIATED WITH REFERENCED TO-204AA OUTLINE SHALL APPLY.

DIM	INCHES		MILLIMETERS	
	MIN	MAX	MIN	MAX
A	1.550 REF		39.37 REF	
B	---	1.050	---	26.67
C	0.250	0.335	6.35	8.51
D	0.038	0.043	0.97	1.09
E	0.055	0.070	1.40	1.77
G	0.430 BSC		10.92 BSC	
H	0.215 BSC		5.46 BSC	
K	0.440	0.480	11.18	12.19
L	0.665 BSC		16.89 BSC	
N	---	0.830	---	21.08
Q	0.151	0.165	3.84	4.19
U	1.187 BSC		30.15 BSC	
V	0.131	0.188	3.33	4.77

STYLE 1:

- PIN 1. BASE
  - EMITTER
- CASE: COLLECTOR

ON Semiconductor and are registered trademarks of Semiconductor Components Industries, LLC (SCILLC). SCILLC reserves the right to make changes without further notice to any products herein. SCILLC makes no warranty, representation or guarantee regarding the suitability of its products for any particular purpose, nor does SCILLC assume any liability arising out of the application or use of any product or circuit, and specifically disclaims any and all liability, including without limitation special, consequential or incidental damages. "Typical" parameters which may be provided in SCILLC data sheets and/or specifications can and do vary in different applications and actual performance may vary over time. All operating parameters, including "Typicals" must be validated for each customer application by customer's technical experts. SCILLC does not convey any license under its patent rights nor the rights of others. SCILLC products are not designed, intended, or authorized for use as components in systems intended for surgical implant into the body, or other applications intended to support or sustain life, or for any other application in which the failure of the SCILLC product could create a situation where personal injury or death may occur. Should Buyer purchase or use SCILLC products for any such unintended or unauthorized application, Buyer shall indemnify and hold SCILLC and its officers, employees, subsidiaries, affiliates, and distributors harmless against all claims, costs, damages, and expenses, and reasonable attorney fees arising out of, directly or indirectly, any claim of personal injury or death associated with such unintended or unauthorized use, even if such claim alleges that SCILLC was negligent regarding the design or manufacture of the part. SCILLC is an Equal Opportunity/Affirmative Action Employer. This literature is subject to all applicable copyright laws and is not for resale in any manner.

### PUBLICATION ORDERING INFORMATION

**LITERATURE FULFILLMENT:**  
Literature Distribution Center for ON Semiconductor  
P.O. Box 5163, Denver, Colorado 80217 USA  
**Phone:** 303-675-2175 or 800-344-3860 Toll Free USA/Canada  
**Fax:** 303-675-2176 or 800-344-3867 Toll Free USA/Canada  
**Email:** orderlit@onsemi.com

**N. American Technical Support:** 800-282-9855 Toll Free  
USA/Canada  
**Europe, Middle East and Africa Technical Support:**  
Phone: 421 33 790 2910  
**Japan Customer Focus Center**  
Phone: 81-3-5773-3850

**ON Semiconductor Website:** [www.onsemi.com](http://www.onsemi.com)  
**Order Literature:** <http://www.onsemi.com/orderlit>  
For additional information, please contact your local Sales Representative

## Данный компонент на территории Российской Федерации

### Вы можете приобрести в компании MosChip.

Для оперативного оформления запроса Вам необходимо перейти по данной ссылке:

<http://moschip.ru/get-element>

Вы можете разместить у нас заказ для любого Вашего проекта, будь то серийное производство или разработка единичного прибора.

В нашем ассортименте представлены ведущие мировые производители активных и пассивных электронных компонентов.

Нашей специализацией является поставка электронной компонентной базы двойного назначения, продукции таких производителей как XILINX, Intel (ex.ALTERA), Vicor, Microchip, Texas Instruments, Analog Devices, Mini-Circuits, Amphenol, Glenair.

Сотрудничество с глобальными дистрибьюторами электронных компонентов, предоставляет возможность заказывать и получать с международных складов практически любой перечень компонентов в оптимальные для Вас сроки.

На всех этапах разработки и производства наши партнеры могут получить квалифицированную поддержку опытных инженеров.

Система менеджмента качества компании отвечает требованиям в соответствии с ГОСТ Р ИСО 9001, ГОСТ РВ 0015-002 и ЭС РД 009

### Офис по работе с юридическими лицами:

105318, г.Москва, ул.Щербаковская д.3, офис 1107, 1118, ДЦ «Щербаковский»

Телефон: +7 495 668-12-70 (многоканальный)

Факс: +7 495 668-12-70 (доб.304)

E-mail: [info@moschip.ru](mailto:info@moschip.ru)

Skype отдела продаж:

moschip.ru

moschip.ru\_4

moschip.ru\_6

moschip.ru\_9