

FEATURES

- Fast settling filter option
- 4 differential/8 pseudo differential input channels
- RMS noise: 11 nV @ 4.7 Hz (gain = 128)
- 15.5 noise-free bits @ 2.4 kHz (gain = 128)
- Up to 22 noise-free bits (gain = 1)
- Offset drift: ± 5 nV/ $^{\circ}$ C
- Gain drift: ± 1 ppm/ $^{\circ}$ C
- Specified drift over time
- Automatic channel sequencer
- Programmable gain (1 to 128)
- Output data rate: 4.7 Hz to 4.8 kHz
- Internal or external clock
- Simultaneous 50 Hz/60 Hz rejection
- 4 general-purpose digital outputs
- Power supply
 - AV_{DD}: 3 V to 5.25 V
 - DV_{DD}: 2.7 V to 5.25 V
- Current: 4.65 mA
- Temperature range: -40° C to $+105^{\circ}$ C
- 28-lead TSSOP and 32-lead LFCSP packages
- Interface
 - 3-wire serial
 - SPI, QSPI™, MICROWIRE™, and DSP compatible
 - Schmitt trigger on SCLK

APPLICATIONS

- PLC/DCS analog input modules
- Data acquisition
- Strain gage transducers

- Pressure measurement
- Temperature measurement
- Flow measurement
- Weigh scales
- Chromatography
- Medical and scientific instrumentation

GENERAL DESCRIPTION

The AD7193 is a low noise, complete analog front end for high precision measurement applications. It contains a low noise, 24-bit sigma-delta (Σ - Δ) analog-to-digital converter (ADC). The on-chip low noise gain stage means that signals of small amplitude can interface directly to the ADC.

The device can be configured to have four differential inputs or eight pseudo differential inputs. The on-chip channel sequencer allows several channels to be enabled simultaneously, and the AD7193 sequentially converts on each enabled channel, simplifying communication with the part. The on-chip 4.92 MHz clock can be used as the clock source to the ADC or, alternatively, an external clock or crystal can be used. The output data rate from the part can be varied from 4.7 Hz to 4.8 kHz.

The device has a very flexible digital filter, including a fast settling option. Variables such as output data rate and settling time are dependent on the option selected. The AD7193 also includes a zero latency option.

The part operates with a power supply from 3 V to 5.25 V. It consumes a current of 4.65 mA, and it is available in a 28-lead TSSOP package and a 32-lead LFCSP package.

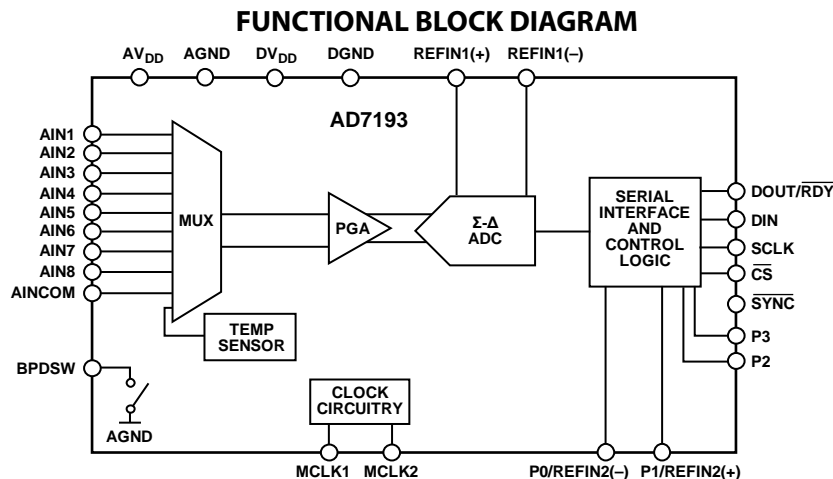

Figure 1.

Rev. E

[Document Feedback](#)

Information furnished by Analog Devices is believed to be accurate and reliable. However, no responsibility is assumed by Analog Devices for its use, nor for any infringements of patents or other rights of third parties that may result from its use. Specifications subject to change without notice. No license is granted by implication or otherwise under any patent or patent rights of Analog Devices. Trademarks and registered trademarks are the property of their respective owners.

One Technology Way, P.O. Box 9106, Norwood, MA 02062-9106, U.S.A.
 Tel: 781.329.4700 ©2009–2017 Analog Devices, Inc. All rights reserved.
[Technical Support](#) www.analog.com

TABLE OF CONTENTS

| | | | |
|--|----|---|----|
| Features | 1 | Reference | 32 |
| Applications | 1 | Reference Detect | 33 |
| General Description | 1 | Bipolar/Unipolar Configuration | 33 |
| Functional Block Diagram | 1 | Data Output Coding | 33 |
| Revision History | 3 | Burnout Currents | 33 |
| Specifications | 4 | Channel Sequencer | 33 |
| Timing Characteristics | 8 | Digital Interface | 34 |
| Absolute Maximum Ratings | 10 | Reset | 38 |
| Thermal Resistance | 10 | System Synchronization | 38 |
| ESD Caution | 10 | Enable Parity | 38 |
| Pin Configurations and Function Descriptions | 11 | Clock | 38 |
| Typical Performance Characteristics | 15 | Bridge Power-Down Switch | 38 |
| RMS Noise and Resolution | 18 | Temperature Sensor | 39 |
| Sinc ⁴ Chop Disabled | 18 | Logic Outputs | 39 |
| Sinc ³ Chop Disabled | 19 | Calibration | 39 |
| Fast Settling | 20 | Digital Filter | 41 |
| On-Chip Registers | 21 | Sinc ⁴ Filter (Chop Disabled) | 41 |
| Communications Register | 22 | Sinc ³ Filter (Chop Disabled) | 43 |
| Status Register | 23 | Chop Enabled (Sinc ⁴ Filter) | 45 |
| Mode Register | 24 | Chop Enabled (Sinc ³ Filter) | 47 |
| Configuration Register | 27 | Fast Settling Mode (Sinc ⁴ Filter) | 48 |
| Data Register | 29 | Fast Settling Mode (Sinc ³ Filter) | 50 |
| ID Register | 29 | Fast Settling Mode (Chop Enabled) | 51 |
| GPOCON Register | 29 | Summary of Filter Options | 52 |
| Offset Register | 30 | Grounding and Layout | 53 |
| Full-Scale Register | 30 | Applications Information | 54 |
| ADC Circuit Information | 31 | Flowmeter | 54 |
| Overview | 31 | Outline Dimensions | 55 |
| Analog Input Channel | 32 | Ordering Guide | 55 |
| Programmable Gain Array (PGA) | 32 | | |

REVISION HISTORY**7/2017—Rev. D to Rev. E**

| | |
|-----------------------------------|------------|
| Changed CP-32-11 to CP-32-12..... | Throughout |
| Updated Outline Dimensions..... | 55 |
| Changes to Ordering Guide..... | 55 |

3/2013—Rev. C to Rev. D

| | |
|--|----|
| Changes to CON2 to CON0 Description; Table 22..... | 28 |
| Changes to Equations in Data Output Coding Section | 33 |

12/2011—Rev. B to Rev. C

| | |
|-------------------------------------|----|
| Moved Revision History Section..... | 3 |
| Changes to Table 6 | 13 |

4/2010—Rev. A to Rev. B

| | |
|---|-----------|
| Added 32-Lead LFCSP | Universal |
| Changes to Table 7 | 17 |
| Changes to Communications Register, Table 16..... | 20 |
| Updated Outline Dimensions..... | 54 |
| Changes to Ordering Guide..... | 54 |

9/2009—Rev. 0 to Rev. A

| | |
|---|----|
| Changes to Internal/External Clock, Internal Clock Frequency Parameter, Table 1 | 5 |
| Changes to Figure 7 and Figure 8 | 14 |
| Changes to Table 6 | 17 |
| Changes to Table 9 | 18 |
| Changes to Table 12, Table 13, and Table 14 | 19 |
| Changes to Table 19 | 24 |
| Changes to Table 22 and Table 23 | 27 |
| Changes to Offset Register and Full-Scale Register Sections.... | 29 |
| Changes to Reference Section | 31 |
| Changes to Data Output Coding Section | 32 |
| Changes to Sinc ⁴ 50 Hz/60 Hz Rejection Section | 41 |
| Changes to Sinc ³ 50 Hz/60 Hz Rejection Section | 43 |
| Changes to 50 Hz/60 Hz Rejection, Sinc ⁴ Filter Section..... | 47 |
| Changes to Summary of Filter Options Section and Table 35 .. | 52 |

7/2009—Revision 0: Initial Version

SPECIFICATIONS

$AV_{DD} = 3\text{ V to }5.25\text{ V}$, $DV_{DD} = 2.7\text{ V to }5.25\text{ V}$, $AGND = DGND = 0\text{ V}$; $REFINx(+)$ = 2.5 V or AV_{DD} , $REFINx(-)$ = AGND, $MCLK = 4.92\text{ MHz}$, $T_A = T_{MIN}$ to T_{MAX} , unless otherwise noted.

Table 1.

| Parameter | Min | Typ | Max | Unit | Test Conditions/Comments ¹ |
|--|-----------------------------|-----------|------|--------------------|---|
| ADC | | | | | |
| Output Data Rate | 4.7 | | 4800 | Hz | Chop disabled |
| | 1.17 | | 1200 | Hz | Chop enabled, sinc ⁴ filter |
| | 1.56 | | 1600 | Hz | Chop enabled, sinc ³ filter |
| No Missing Codes ² | 24 | | | Bits | FS[9:0] ³ > 1, sinc ⁴ filter |
| | 24 | | | Bits | FS[9:0] ³ > 4, sinc ³ filter |
| Resolution | | | | | See the RMS Noise and Resolution section |
| RMS Noise and Output Data Rates | | | | | See the RMS Noise and Resolution section |
| Integral Nonlinearity Gain = 1 ² | | ±2 | ±10 | ppm of FSR | $AV_{DD} = 5\text{ V}$ |
| | | ±2 | ±15 | ppm of FSR | $AV_{DD} = 3\text{ V}$ |
| Gain > 1 | | ±5 | ±30 | ppm of FSR | $AV_{DD} = 5\text{ V}$ |
| | | ±15 | ±30 | ppm of FSR | $AV_{DD} = 3\text{ V}$ |
| Offset Error ^{4,5} | | ±150/gain | | µV | Chop disabled |
| | | ±1 | | µV | Chop enabled, $AV_{DD} = 5\text{ V}$ |
| | | ±0.5 | | µV | Chop enabled, $AV_{DD} = 3\text{ V}$ |
| Offset Error Drift vs. Temperature | | ±150/gain | | nV/°C | Gain = 1 to 16; chop disabled |
| | | ±5 | | nV/°C | Gain = 32 to 128; chop disabled |
| Offset Error Drift vs. Time | | ±5 | | nV/°C | Chop enabled |
| | | 25 | | nV/1000 hours | Gain > 32 |
| Gain Error ⁴ | | ±0.001 | | % | $AV_{DD} = 5\text{ V}$, gain = 1, $T_A = 25^\circ\text{C}$ (factory calibration conditions) |
| | | -0.39 | | % | Gain = 128, before full-scale calibration (see Table 27) |
| | | ±0.003 | | % | Gain > 1, after internal full-scale calibration, $AV_{DD} \geq 4.75\text{ V}$ |
| | | ±0.005 | | % | Gain > 1, after internal full-scale calibration, $AV_{DD} < 4.75\text{ V}$ |
| Gain Drift vs. Temperature | | ±1 | | ppm/°C | |
| Gain Drift vs. Time | | 10 | | ppm/ 1000 hours | Gain = 1 |
| Power Supply Rejection | | 90 | | dB | Gain = 1, $V_{IN} = 1\text{ V}$ |
| | 95 | 110 | | dB | Gain > 1, $V_{IN} = 1\text{ V/gain}$ |
| Common-Mode Rejection | @ DC | | 110 | dB | Gain = 1, $V_{IN} = 1\text{ V}$ |
| | @ DC | 105 | | dB | Gain > 1, $V_{IN} = 1\text{ V/gain}$ |
| | @ 50 Hz, 60 Hz ² | 120 | | dB | 10 Hz output data rate, 50 Hz ± 1 Hz, 60 Hz ± 1 Hz |
| | @ 50 Hz ² | 120 | | dB | 50 Hz output data rate, 50 Hz ± 1 Hz |
| | @ 60 Hz ² | 120 | | dB | 60 Hz output data rate, 60 Hz ± 1 Hz |
| | @ 50 Hz ² | 115 | | dB | Fast settling, FS[9:0] ³ = 6, average by 16, 50 Hz ± 1 Hz |
| | @ 60 Hz ² | 115 | | dB | Fast settling, FS[9:0] ³ = 5, average by 16, 60 Hz ± 1 Hz |

| Parameter | Min | Typ | Max | Unit | Test Conditions/Comments ¹ |
|--|-----------------------------------|-------------------------|-----------------------------------|---------|--|
| Normal-Mode Rejection ² | | | | | |
| Sinc ⁴ Filter | | | | | |
| Internal Clock | | | | | |
| @ 50 Hz, 60 Hz | 100 | | | dB | 10 Hz output data rate, 50 Hz ± 1 Hz, 60 Hz ± 1 Hz |
| | 74 | | | dB | 50 Hz output data rate, REJ60 ⁶ = 1, 50 Hz ± 1 Hz, 60 Hz ± 1 Hz |
| @ 50 Hz | 96 | | | dB | 50 Hz output data rate, 50 Hz ± 1 Hz |
| @ 60 Hz | 97 | | | dB | 60 Hz output data rate, 60 Hz ± 1 Hz |
| External Clock | | | | | |
| @ 50 Hz, 60 Hz | 120 | | | dB | 10 Hz output data rate, 50 Hz ± 1 Hz, 60 Hz ± 1 Hz |
| | 82 | | | dB | 50 Hz output data rate, REJ60 ⁶ = 1, 50 Hz ± 1 Hz, 60 Hz ± 1 Hz |
| @ 50 Hz | 120 | | | dB | 50 Hz output data rate, 50 Hz ± 1 Hz |
| @ 60 Hz | 120 | | | dB | 60 Hz output data rate, 60 Hz ± 1 Hz |
| Sinc ³ Filter | | | | | |
| Internal Clock | | | | | |
| @ 50 Hz, 60 Hz | 75 | | | dB | 10 Hz output data rate, 50 Hz ± 1 Hz, 60 Hz ± 1 Hz |
| | 60 | | | dB | 50 Hz output data rate, REJ60 ⁶ = 1, 50 Hz ± 1 Hz, 60 Hz ± 1 Hz |
| @ 50 Hz | 70 | | | dB | 50 Hz output data rate, 50 Hz ± 1 Hz |
| @ 60 Hz | 70 | | | dB | 60 Hz output data rate, 60 Hz ± 1 Hz |
| External Clock | | | | | |
| @ 50 Hz, 60 Hz | 100 | | | dB | 10 Hz output data rate, 50 Hz ± 1 Hz, 60 Hz ± 1 Hz |
| @ 50 Hz | 67 | | | dB | 50 Hz output data rate, REJ60 ⁶ = 1, 50 Hz ± 1 Hz, 60 Hz ± 1 Hz |
| @ 50 Hz | 95 | | | dB | 50 Hz output data rate, 50 Hz ± 1 Hz |
| @ 60 Hz | 95 | | | dB | 60 Hz output data rate, 60 Hz ± 1 Hz |
| Fast Settling | | | | | |
| Internal Clock | | | | | |
| @ 50 Hz | 26 | | | dB | FS[9:0] ³ = 6, average by 16, 50 Hz ± 0.5 Hz |
| @ 60 Hz | 26 | | | dB | FS[9:0] ³ = 5, average by 16, 60 Hz ± 0.5 Hz |
| External Clock | | | | | |
| @ 50 Hz | 40 | | | dB | FS[9:0] ³ = 6, average by 16, 50 Hz ± 0.5 Hz |
| @ 60 Hz | 40 | | | dB | FS[9:0] ³ = 5, average by 16, 60 Hz ± 0.5 Hz |
| ANALOG INPUTS | | | | | |
| Differential Input Voltage Ranges | | ±V _{REF} /gain | | V | V _{REF} = REFINx(+) – REFINx(-), gain = 1 to 128 |
| Absolute AIN Voltage Limits ² | -(AV _{DD} – 1.25 V)/gain | | +(AV _{DD} – 1.25 V)/gain | V | Gain > 1 |
| Unbuffered Mode | AGND – 0.05 | | AV _{DD} + 0.05 | V | |
| Buffered Mode | AGND + 0.25 | | AV _{DD} – 0.25 | V | |
| Analog Input Current | | | | | |
| Buffered Mode | | | | | |
| Input Current ² | -2 | | +2 | nA | Gain = 1 |
| | -3 | | +3 | nA | Gain > 1 |
| Input Current Drift | | ±5 | | pA/°C | |
| Unbuffered Mode | | | | | |
| Input Current | | ±3.5 | | μA/V | Gain = 1, input current varies with input voltage |
| Input Current Drift | | ±1 | | μA/V | Gain > 1 |
| Input Current Drift | | ±0.05 | | nA/V/°C | External clock |
| | | ±1.6 | | nA/V/°C | Internal clock |

| Parameter | Min | Typ | Max | Unit | Test Conditions/Comments ¹ |
|---|-----------------|---------------------------|------------------|-----------------|--|
| REFERENCE INPUT | | | | | |
| REFIN Voltage | 1 | | AV_{DD} | V | REFIN = REFINx(+) – REFINx(-), the differential input must be limited to $\pm(AV_{DD} - 1.25 \text{ V})/\text{gain}$ when gain > 1 |
| Absolute REFIN Voltage Limits ² | AGND – 0.05 | | $AV_{DD} + 0.05$ | V | |
| Average Reference Input Current | | 4.5 | | $\mu\text{A/V}$ | |
| Average Reference Input Current Drift | | ± 0.03 | | nA/V/°C | External clock |
| Normal Mode Rejection ² | | ± 1.3 | | nA/V/°C | Internal clock |
| Common-Mode Rejection | | Same as for analog inputs | | | |
| Reference Detect Levels | 0.3 | 100 | 0.6 | V | |
| TEMPERATURE SENSOR | | | | | |
| Accuracy | | ± 2 | | °C | Applies after user calibration at 25°C |
| Sensitivity | | 2815 | | Codes/°C | Bipolar mode |
| BRIDGE POWER-DOWN SWITCH | | | | | |
| R_{ON} | | | 10 | Ω | |
| Allowable Current ² | | | 30 | mA | Continuous current |
| BURNOUT CURRENTS | | | | | |
| AIN Current | | 500 | | nA | Analog inputs must be buffered and chop disabled |
| DIGITAL OUTPUTS (P0 to P3) | | | | | |
| Output High Voltage, V_{OH} | $AV_{DD} - 0.6$ | | | V | $AV_{DD} = 3 \text{ V}, I_{SOURCE} = 100 \mu\text{A}$ |
| | 4 | | | V | $AV_{DD} = 5 \text{ V}, I_{SOURCE} = 200 \mu\text{A}$ |
| Output Low Voltage, V_{OL} | | | 0.4 | V | $AV_{DD} = 3 \text{ V}, I_{SINK} = 100 \mu\text{A}$ |
| | | | 0.4 | V | $AV_{DD} = 5 \text{ V}, I_{SINK} = 800 \mu\text{A}$ |
| Floating-State Leakage Current ² | -100 | | +100 | nA | |
| Floating-State Output Capacitance | | 10 | | pF | |
| INTERNAL/EXTERNAL CLOCK | | | | | |
| Internal Clock | | | | | |
| Frequency | 4.72 | 4.92 | 5.12 | MHz | |
| Duty Cycle | | 50:50 | | % | |
| External Clock/Crystal | | | | | |
| Frequency | 2.4576 | 4.9152 | 5.12 | MHz | |
| Input Low Voltage, V_{INL} | | | 0.8 | V | $DV_{DD} = 5 \text{ V}$ |
| | | | 0.4 | V | $DV_{DD} = 3 \text{ V}$ |
| Input High Voltage, V_{INH} | 2.5 | | | V | $DV_{DD} = 3 \text{ V}$ |
| | 3.5 | | | V | $DV_{DD} = 5 \text{ V}$ |
| Input Current | -10 | | +10 | μA | |
| LOGIC INPUTS | | | | | |
| Input High Voltage, V_{INH}^2 | 2 | | | V | |
| Input Low Voltage, V_{INL}^2 | | | 0.8 | V | |
| Hysteresis ² | 0.1 | | 0.25 | V | |
| Input Currents | -10 | | +10 | μA | |
| LOGIC OUTPUT (DOUT/RDY) | | | | | |
| Output High Voltage, V_{OH}^2 | $DV_{DD} - 0.6$ | | | V | $DV_{DD} = 3 \text{ V}, I_{SOURCE} = 100 \mu\text{A}$ |
| | 4 | | | V | $DV_{DD} = 5 \text{ V}, I_{SOURCE} = 200 \mu\text{A}$ |
| Output Low Voltage, V_{OL}^2 | | | 0.4 | V | $DV_{DD} = 3 \text{ V}, I_{SINK} = 100 \mu\text{A}$ |
| | | | 0.4 | V | $DV_{DD} = 5 \text{ V}, I_{SINK} = 1.6 \text{ mA}$ |
| Floating-State Leakage Current | -10 | | +10 | μA | |
| Floating-State Output Capacitance | | 10 | | pF | |

| Parameter | Min | Typ | Max | Unit | Test Conditions/Comments ¹ |
|---------------------------------|---------------|------|-----------|------|--|
| Data Output Coding | Offset binary | | | | |
| SYSTEM CALIBRATION ² | | | | | |
| Full-Scale Calibration Limit | | | 1.05 × FS | V | |
| Zero-Scale Calibration Limit | -1.05 × FS | | | V | |
| Input Span | 0.8 × FS | | 2.1 × FS | V | |
| POWER REQUIREMENTS ⁷ | | | | | |
| Power Supply Voltage | | | | | |
| AV _{DD} – AGND | 3 | | 5.25 | V | |
| DV _{DD} – DGND | 2.7 | | 5.25 | V | |
| Power Supply Currents | | | | | |
| I _{DD} Current | | 0.85 | 1 | mA | Gain = 1, buffer off |
| | | 1 | 1.25 | mA | Gain = 1, buffer on |
| | | 2.8 | 3.6 | mA | Gain = 8, buffer off |
| | | 3.2 | 3.9 | mA | Gain = 8, buffer on |
| | | 3.8 | 4.7 | mA | Gain = 16 to 128, buffer off |
| D _{DD} Current | | 4.3 | 5.3 | mA | Gain = 16 to 128, buffer on |
| | | 0.35 | 0.4 | mA | DV _{DD} = 3 V |
| | | 0.5 | 0.6 | mA | DV _{DD} = 5 V |
| I _{DD} | | 1.5 | 3 | μA | External crystal used Power-down mode |

¹ Temperature range: -40°C to +105°C.

² Specification is not production tested but is supported by characterization data at initial product release.

³ FS[9:0] is the decimal equivalent of Bit FS9 to Bit FS0 in the mode register.

⁴ Following a system or internal zero-scale calibration, the offset error is in the order of the noise for the programmed gain and output data rate selected. A system full-scale calibration reduces the gain error to the order of the noise for the programmed gain and output data rate.

⁵ The analog inputs are configured for differential mode.

⁶ REJ60 is a bit in the mode register. When the first notch of the sinc filter is at 50 Hz, a notch is placed at 60 Hz when REJ60 is set to 1. This gives simultaneous 50 Hz/60 Hz rejection.

⁷ Digital inputs equal to DV_{DD} or DGND.

TIMING CHARACTERISTICS

$AV_{DD} = 3\text{ V}$ to 5.25 V , $DV_{DD} = 2.7\text{ V}$ to 5.25 V , $AGND = DGND = 0\text{ V}$, Input Logic 0 = 0 V , Input Logic 1 = DV_{DD} , unless otherwise noted.

Table 2.

| Parameter | Limit at T_{MIN} , T_{MAX} (B Version) | Unit | Conditions/Comments ^{1, 2} |
|---------------------------|--|--------|--|
| READ AND WRITE OPERATIONS | | | |
| t_3 | 100 | ns min | SCLK high pulse width |
| t_4 | 100 | ns min | SCLK low pulse width |
| READ OPERATION | | | |
| t_1 | 0 | ns min | \overline{CS} falling edge to DOUT/ \overline{RDY} active time |
| | 60 | ns max | $DV_{DD} = 4.75\text{ V}$ to 5.25 V |
| | 80 | ns max | $DV_{DD} = 2.7\text{ V}$ to 3.6 V |
| t_2^3 | 0 | ns min | SCLK active edge to data valid delay ⁴ |
| | 60 | ns max | $DV_{DD} = 4.75\text{ V}$ to 5.25 V |
| | 80 | ns max | $DV_{DD} = 2.7\text{ V}$ to 3.6 V |
| $t_5^{5, 6}$ | 10 | ns min | Bus relinquish time after \overline{CS} inactive edge |
| | 80 | ns max | |
| t_6 | 0 | ns min | SCLK inactive edge to \overline{CS} inactive edge |
| t_7 | 10 | ns min | SCLK inactive edge to DOUT/ \overline{RDY} high |
| WRITE OPERATION | | | |
| t_8 | 0 | ns min | \overline{CS} falling edge to SCLK active edge setup time ⁴ |
| t_9 | 30 | ns min | Data valid to SCLK edge setup time |
| t_{10} | 25 | ns min | Data valid to SCLK edge hold time |
| t_{11} | 0 | ns min | \overline{CS} rising edge to SCLK edge hold time |

¹ Sample tested during initial release to ensure compliance. All input signals are specified with $t_R = t_F = 5\text{ ns}$ (10% to 90% of DV_{DD}) and timed from a voltage level of 1.6 V .

² See Figure 3 and Figure 4.

³ These numbers are measured with the load circuit shown in Figure 2 and defined as the time required for the output to cross the V_{OL} or V_{OH} limits.

⁴ The SCLK active edge is the falling edge of SCLK.

⁵ These numbers are derived from the measured time taken by the data output to change 0.5 V when loaded with the circuit shown in Figure 2. The measured number is then extrapolated back to remove the effects of charging or discharging the 50 pF capacitor. This means that the times quoted in the timing characteristics are the true bus relinquish times of the part and, as such, are independent of external bus loading capacitances.

⁶ \overline{RDY} returns high after a read of the data register. In single conversion mode and continuous conversion mode, the same data can be read again, if required, while \overline{RDY} is high, although care should be taken to ensure that subsequent reads do not occur close to the next output update. If the continuous read feature is enabled, the digital word can be read only once.

Circuit and Timing Diagrams

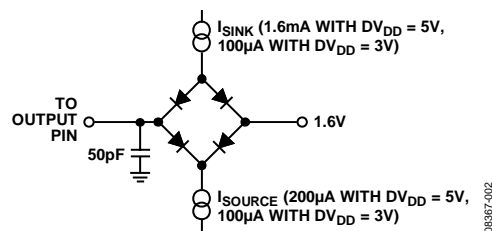

Figure 2. Load Circuit for Timing Characterization

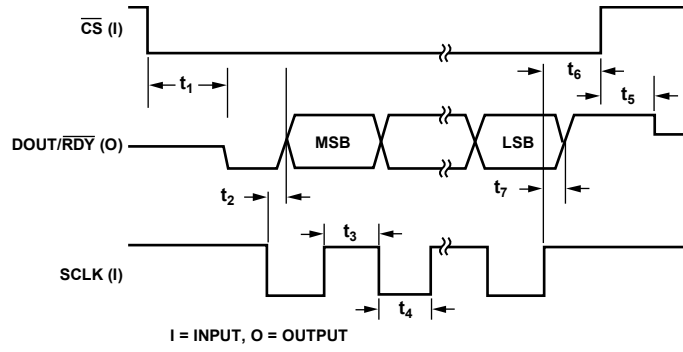

Figure 3. Read Cycle Timing Diagram

08387-003

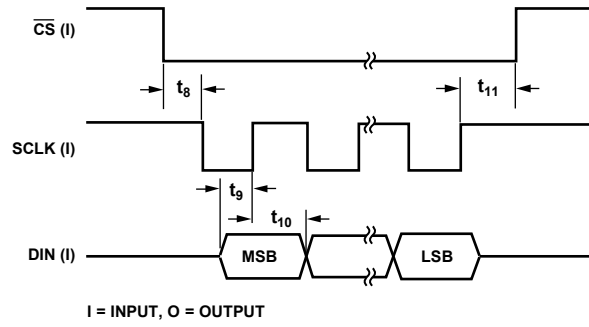

Figure 4. Write Cycle Timing Diagram

08387-004

ABSOLUTE MAXIMUM RATINGS

$T_A = 25^\circ\text{C}$, unless otherwise noted.

Table 3.

| Parameter | Rating |
|------------------------------------|---|
| AV_{DD} to AGND | -0.3 V to +6.5 V |
| DV_{DD} to AGND | -0.3 V to +6.5 V |
| AGND to DGND | -0.3 V to +0.3 V |
| Analog Input Voltage to AGND | -0.3 V to $AV_{DD} + 0.3$ V |
| Reference Input Voltage to AGND | -0.3 V to $AV_{DD} + 0.3$ V |
| Digital Input Voltage to DGND | -0.3 V to $DV_{DD} + 0.3$ V |
| Digital Output Voltage to DGND | -0.3 V to $DV_{DD} + 0.3$ V |
| AINx/Digital Input Current | 10 mA |
| Operating Temperature Range | -40°C to $+105^\circ\text{C}$ |
| Storage Temperature Range | -65°C to $+150^\circ\text{C}$ |
| Maximum Junction Temperature | 150°C |
| Lead Temperature, Soldering Reflow | 260°C |

Stresses at or above those listed under Absolute Maximum Ratings may cause permanent damage to the product. This is a stress rating only; functional operation of the product at these or any other conditions above those indicated in the operational section of this specification is not implied. Operation beyond the maximum operating conditions for extended periods may affect product reliability.

THERMAL RESISTANCE

θ_{JA} is specified for the worst-case conditions, that is, a device soldered in a circuit board for the surface-mount packages.

Table 4. Thermal Resistance

| Package Type | θ_{JA} | θ_{JC} | Unit |
|---------------|---------------|---------------|---------------------------|
| 28-Lead TSSOP | 97.9 | 14 | $^\circ\text{C}/\text{W}$ |
| 32-Lead LFCSP | 32.5 | 32.71 | $^\circ\text{C}/\text{W}$ |

ESD CAUTION



ESD (electrostatic discharge) sensitive device. Charged devices and circuit boards can discharge without detection. Although this product features patented or proprietary protection circuitry, damage may occur on devices subjected to high energy ESD. Therefore, proper ESD precautions should be taken to avoid performance degradation or loss of functionality.

PIN CONFIGURATIONS AND FUNCTION DESCRIPTIONS

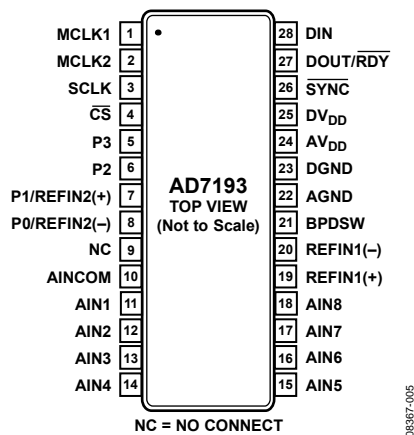
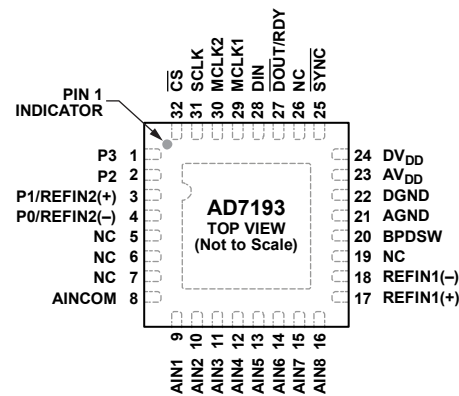

Figure 5. 28-lead TSSOP Pin Configuration

Table 5. 28-lead TSSOP Pin Function Descriptions

| Pin No. | Mnemonic | Description |
|---------|-----------------|--|
| 1 | MCLK1 | When the master clock for the device is provided externally by a crystal, the crystal is connected between MCLK1 and MCLK2. |
| 2 | MCLK2 | Master Clock Signal for the Device. The AD7193 has an internal 4.92 MHz clock. This internal clock can be made available on the MCLK2 pin. The clock for the AD7193 can also be provided externally in the form of a crystal or external clock. A crystal can be tied across the MCLK1 and MCLK2 pins. Alternatively, the MCLK2 pin can be driven with a CMOS-compatible clock and with the MCLK1 pin remaining unconnected. |
| 3 | SCLK | Serial Clock Input. This serial clock input is for data transfers to and from the ADC. The SCLK has a Schmitt-triggered input, making the interface suitable for opto-isolated applications. The serial clock can be continuous with all data transmitted in a continuous train of pulses. Alternatively, it can be a noncontinuous clock with the information transmitted to or from the ADC in smaller batches of data. |
| 4 | \overline{CS} | Chip Select Input. This is an active low logic input used to select the ADC. \overline{CS} can be used to select the ADC in systems with more than one device on the serial bus or as a frame synchronization signal in communicating with the device. \overline{CS} can be hardwired low, allowing the ADC to operate in 3-wire mode with SCLK, DIN, and DOUT used to interface with the device. |
| 5 | P3 | Digital Output Pin. This pin can function as a general-purpose output bit referenced between AV_{DD} and AGND. |
| 6 | P2 | Digital Output Pin. This pin can function as a general-purpose output bit referenced between AV_{DD} and AGND. |
| 7 | P1/REFIN2(+) | Digital Output Pin/Positive Reference Input. This pin functions as a general-purpose output bit referenced between AV_{DD} and AGND. When the REFSEL bit in the configuration register = 1, this pin functions as REFIN2(+). An external reference can be applied between REFIN2(+) and REFIN2(-). REFIN2(+) can lie anywhere between AV_{DD} and AGND + 1 V. The nominal reference voltage, (REFIN2(+) – REFIN2(-)), is AV_{DD} , but the part functions with a reference from 1 V to AV_{DD} . |
| 8 | P0/REFIN2(-) | Digital Output Pin/Negative Reference Input. This pin functions as a general-purpose output bit referenced between AV_{DD} and AGND. When the REFSEL bit in the configuration register = 1, this pin functions as REFIN2(-). This reference input can lie anywhere between AGND and $AV_{DD} - 1$ V. |
| 9 | NC | No Connect. Tie this pin to AGND. |
| 10 | AINCOM | Analog Input AIN1 to Analog Input AIN8 are referenced to this input when configured for pseudo differential operation. |
| 11 | AIN1 | Analog Input. This pin can be configured as the positive input of a fully differential input pair when used with AIN2 or as a pseudo differential input when used with AINCOM. |
| 12 | AIN2 | Analog Input. This pin can be configured as the negative input of a fully differential input pair when used with AIN1 or as a pseudo differential input when used with AINCOM. |
| 13 | AIN3 | Analog Input. This pin can be configured as the positive input of a fully differential input pair when used with AIN4 or as a pseudo differential input when used with AINCOM. |

| Pin No. | Mnemonic | Description |
|---------|-----------------------|---|
| 14 | AIN4 | Analog Input. This pin can be configured as the negative input of a fully differential input pair when used with AIN3 or as a pseudo differential input when used with AINCOM. |
| 15 | AIN5 | Analog Input. This pin can be configured as the positive input of a fully differential input pair when used with AIN6 or as a pseudo differential input when used with AINCOM. |
| 16 | AIN6 | Analog Input. This pin can be configured as the negative input of a fully differential input pair when used with AIN5 or as a pseudo differential input when used with AINCOM. |
| 17 | AIN7 | Analog Input. This pin can be configured as the positive input of a fully differential input pair when used with AIN8 or as a pseudo differential input when used with AINCOM. |
| 18 | AIN8 | Analog Input. This pin can be configured as the negative input of a fully differential input pair when used with AIN7 or as a pseudo differential input when used with AINCOM. |
| 19 | REFIN1(+) | Positive Reference Input. An external reference can be applied between REFIN1(+) and REFIN1(-). REFIN1(+) can lie anywhere between AV_{DD} and $AGND + 1 V$. The nominal reference voltage, $(REFIN1(+) - REFIN1(-))$, is AV_{DD} , but the part functions with a reference from 1 V to AV_{DD} . |
| 20 | REFIN1(-) | Negative Reference Input. This reference input can lie anywhere between $AGND$ and $AV_{DD} - 1 V$. |
| 21 | BPDSW | Bridge Power-Down Switch to $AGND$. |
| 22 | AGND | Analog Ground Reference Point. |
| 23 | DGND | Digital Ground Reference Point. |
| 24 | AV_{DD} | Analog Supply Voltage, 3 V to 5.25 V. AV_{DD} is independent of DV_{DD} . Therefore, DV_{DD} can be operated at 3 V with AV_{DD} at 5 V or vice versa. |
| 25 | DV_{DD} | Digital Supply Voltage, 2.7 V to 5.25 V. DV_{DD} is independent of AV_{DD} . Therefore, AV_{DD} can be operated at 3 V with DV_{DD} at 5 V or vice versa. |
| 26 | \overline{SYNC} | Logic input that allows for synchronization of the digital filters and analog modulators when using a number of AD7193 devices. While \overline{SYNC} is low, the nodes of the digital filter, the filter control logic, and the calibration control logic are reset, and the analog modulator is also held in its reset state. \overline{SYNC} does not affect the digital interface but does reset \overline{RDY} to a high state if it is low. \overline{SYNC} has a pull-up resistor internally to DV_{DD} . |
| 27 | $DOUT/\overline{RDY}$ | Serial Data Output/Data Ready Output. $DOUT/\overline{RDY}$ serves a dual purpose. It functions as a serial data output pin to access the output shift register of the ADC. The output shift register can contain data from any of the on-chip data or control registers. In addition, $DOUT/\overline{RDY}$ operates as a data ready pin, going low to indicate the completion of a conversion. If the data is not read after the conversion, the pin goes high before the next update occurs. The $DOUT/\overline{RDY}$ falling edge can be used as an interrupt to a processor, indicating that valid data is available. With an external serial clock, the data can be read using the $DOUT/\overline{RDY}$ pin. With \overline{CS} low, the data-/control-word information is placed on the $DOUT/\overline{RDY}$ pin on the $SCLK$ falling edge and is valid on the $SCLK$ rising edge. |
| 28 | DIN | Serial Data Input to the Input Shift Register on the ADC. Data in this shift register is transferred to the control registers in the ADC, with the register selection bits of the communications register identifying the appropriate register. |



- NOTES
 1. NC = NO CONNECT.
 2. CONNECT EXPOSED PAD TO AGND.

06367-065

Figure 6. 32-Lead LFCSP Pin Configuration

Table 6. 32-Lead LFCSP Pin Function Descriptions

| Pin No. | Mnemonic | Description |
|-----------------|--------------|--|
| 1 | P3 | Digital Output Pin. This pin can function as a general-purpose output bit referenced between AV_{DD} and AGND. |
| 2 | P2 | Digital Output Pin. This pin can function as a general-purpose output bit referenced between AV_{DD} and AGND. |
| 3 | P1/REFIN2(+) | Digital Output Pin/Positive Reference Input. This pin functions as a general-purpose output bit referenced between AV_{DD} and AGND. When the REFSEL bit in the configuration register = 1, this pin functions as REFIN2(+). An external reference can be applied between REFIN2(+) and REFIN2(-). REFIN2(+) can lie anywhere between AV_{DD} and $AGND + 1 V$. The nominal reference voltage, $(REFIN2(+) - REFIN2(-))$, is AV_{DD} , but the part functions with a reference from 1 V to AV_{DD} . |
| 4 | P0/REFIN2(-) | Digital Output Pin/Negative Reference Input. This pin functions as a general-purpose output bit referenced between AV_{DD} and AGND. When the REFSEL bit in the configuration register = 1, this pin functions as REFIN2(-). This reference input can lie anywhere between AGND and $AV_{DD} - 1 V$. |
| 5, 6, 7, 19, 26 | NC | No Connect. Tie these pins to AGND. |
| 8 | AINCOM | Analog Input AIN1 to Analog Input AIN8 are referenced to this input when configured for pseudo differential operation. |
| 9 | AIN1 | Analog Input. This pin can be configured as the positive input of a fully differential input pair when used with AIN2 or as a pseudo differential input when used with AINCOM. |
| 10 | AIN2 | Analog Input. This pin can be configured as the negative input of a fully differential input pair when used with AIN1 or as a pseudo differential input when used with AINCOM. |
| 11 | AIN3 | Analog Input. This pin can be configured as the positive input of a fully differential input pair when used with AIN4 or as a pseudo differential input when used with AINCOM. |
| 12 | AIN4 | Analog Input. This pin can be configured as the negative input of a fully differential input pair when used with AIN3 or as a pseudo differential input when used with AINCOM. |
| 13 | AIN5 | Analog Input. This pin can be configured as the positive input of a fully differential input pair when used with AIN6 or as a pseudo differential input when used with AINCOM. |
| 14 | AIN6 | Analog Input. This pin can be configured as the negative input of a fully differential input pair when used with AIN5 or as a pseudo differential input when used with AINCOM. |
| 15 | AIN7 | Analog Input. This pin can be configured as the positive input of a fully differential input pair when used with AIN8 or as a pseudo differential input when used with AINCOM. |
| 16 | AIN8 | Analog Input. This pin can be configured as the negative input of a fully differential input pair when used with AIN7 or as a pseudo differential input when used with AINCOM. |
| 17 | REFIN1(+) | Positive Reference Input. An external reference can be applied between REFIN1(+) and REFIN1(-). REFIN1(+) can lie anywhere between AV_{DD} and $AGND + 1 V$. The nominal reference voltage, $(REFIN1(+) - REFIN1(-))$, is AV_{DD} , but the part functions with a reference from 1 V to AV_{DD} . |
| 18 | REFIN1(-) | Negative Reference Input. This reference input can lie anywhere between AGND and $AV_{DD} - 1 V$. |
| 20 | BPDSW | Bridge Power-Down Switch to AGND. |

| Pin No. | Mnemonic | Description |
|---------|-------------------------------|--|
| 21 | AGND | Analog Ground Reference Point. |
| 22 | DGND | Digital Ground Reference Point. |
| 23 | AV _{DD} | Analog Supply Voltage, 3 V to 5.25 V. AV _{DD} is independent of DV _{DD} . Therefore, DV _{DD} can be operated at 3 V with AV _{DD} at 5 V or vice versa. |
| 24 | DV _{DD} | Digital Supply Voltage, 2.7 V to 5.25 V. DV _{DD} is independent of AV _{DD} . Therefore, AV _{DD} can be operated at 3 V with DV _{DD} at 5 V or vice versa. |
| 25 | $\overline{\text{SYNC}}$ | Logic input that allows for synchronization of the digital filters and analog modulators when using a number of AD7193 devices. While $\overline{\text{SYNC}}$ is low, the nodes of the digital filter, the filter control logic, and the calibration control logic are reset, and the analog modulator is also held in its reset state. $\overline{\text{SYNC}}$ does not affect the digital interface but does reset $\overline{\text{RDY}}$ to a high state if it is low. $\overline{\text{SYNC}}$ has a pull-up resistor internally to DV _{DD} . |
| 27 | DOUT/ $\overline{\text{RDY}}$ | Serial Data Output/Data Ready Output. DOUT/ $\overline{\text{RDY}}$ serves a dual purpose. It functions as a serial data output pin to access the output shift register of the ADC. The output shift register can contain data from any of the on-chip data or control registers. In addition, DOUT/ $\overline{\text{RDY}}$ operates as a data ready pin, going low to indicate the completion of a conversion. If the data is not read after the conversion, the pin goes high before the next update occurs. The DOUT/ $\overline{\text{RDY}}$ falling edge can be used as an interrupt to a processor, indicating that valid data is available. With an external serial clock, the data can be read using the DOUT/ $\overline{\text{RDY}}$ pin. With $\overline{\text{CS}}$ low, the data-/control-word information is placed on the DOUT/ $\overline{\text{RDY}}$ pin on the SCLK falling edge and is valid on the SCLK rising edge. |
| 28 | DIN | Serial Data Input to the Input Shift Register on the ADC. Data in this shift register is transferred to the control registers in the ADC, with the register selection bits of the communications register identifying the appropriate register. |
| 29 | MCLK1 | When the master clock for the device is provided externally by a crystal, the crystal is connected between MCLK1 and MCLK2. |
| 30 | MCLK2 | Master Clock Signal for the Device. The AD7193 has an internal 4.92 MHz clock. This internal clock can be made available on the MCLK2 pin. The clock for the AD7193 can also be provided externally in the form of a crystal or external clock. A crystal can be tied across the MCLK1 and MCLK2 pins. Alternatively, the MCLK2 pin can be driven with a CMOS-compatible clock and with the MCLK1 pin remaining unconnected. |
| 31 | SCLK | Serial Clock Input. This serial clock input is for data transfers to and from the ADC. The SCLK has a Schmitt-triggered input, making the interface suitable for opto-isolated applications. The serial clock can be continuous with all data transmitted in a continuous train of pulses. Alternatively, it can be a noncontinuous clock with the information transmitted to or from the ADC in smaller batches of data. |
| 32 | $\overline{\text{CS}}$ | Chip Select Input. This is an active low logic input used to select the ADC. $\overline{\text{CS}}$ can be used to select the ADC in systems with more than one device on the serial bus or as a frame synchronization signal in communicating with the device. $\overline{\text{CS}}$ can be hardwired low, allowing the ADC to operate in 3-wire mode with SCLK, DIN, and DOUT used to interface with the device. |
| | EPAD | The exposed pad must be connected to AGND. |

TYPICAL PERFORMANCE CHARACTERISTICS

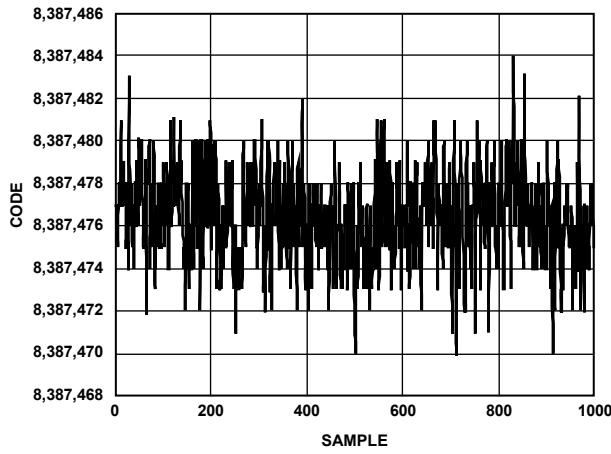

Figure 7. Noise ($V_{REF} = AV_{DD} = 5\text{ V}$, Output Data Rate = 4.7 Hz, Gain = 128, Chop Disabled, Sinc⁴ Filter)

08387-006

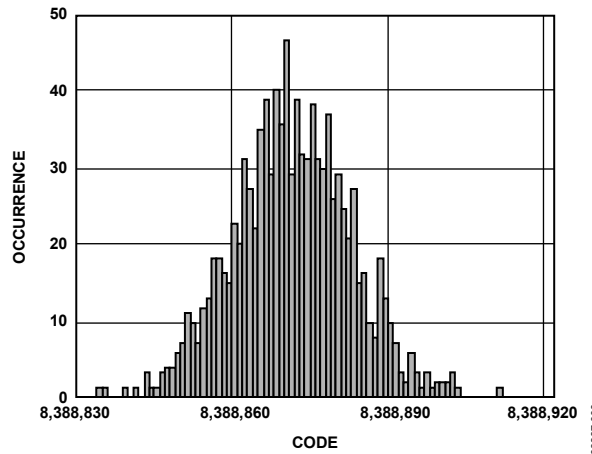

Figure 10. Noise Distribution Histogram ($V_{REF} = AV_{DD} = 5\text{ V}$, Output Data Rate = 2400 Hz, Gain = 1, Chop Disabled, Sinc⁴ Filter)

08387-009

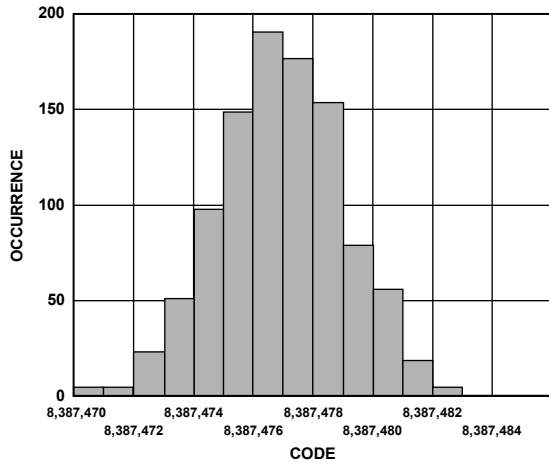

Figure 8. Noise Distribution Histogram ($V_{REF} = AV_{DD} = 5\text{ V}$, Output Data Rate = 4.7 Hz, Gain = 128, Chop Disabled, Sinc⁴ Filter)

08387-007

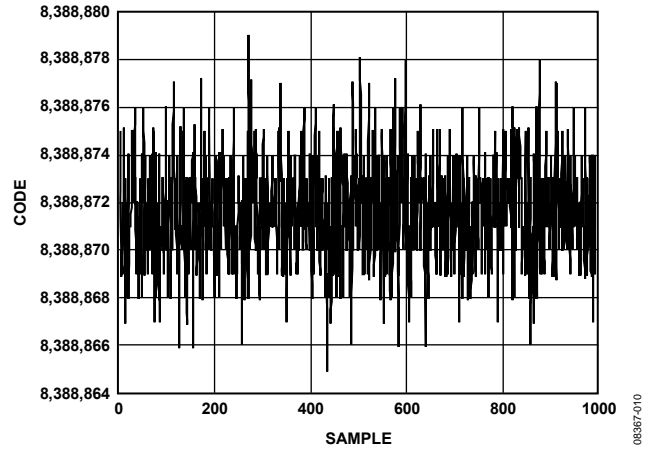

Figure 11. Noise ($V_{REF} = AV_{DD} = 5\text{ V}$, Output Data Rate = 42.1 Hz (FS[9:0] = 6, Average by 16), Gain = 1, Chop Disabled, Sinc⁴ Filter)

08387-010

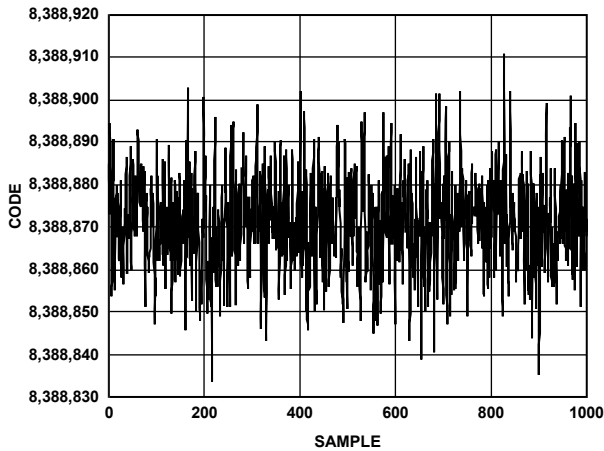

Figure 9. Noise ($V_{REF} = AV_{DD} = 5\text{ V}$, Output Data Rate = 2400 Hz, Gain = 1, Chop Disabled, Sinc⁴ Filter)

08387-008

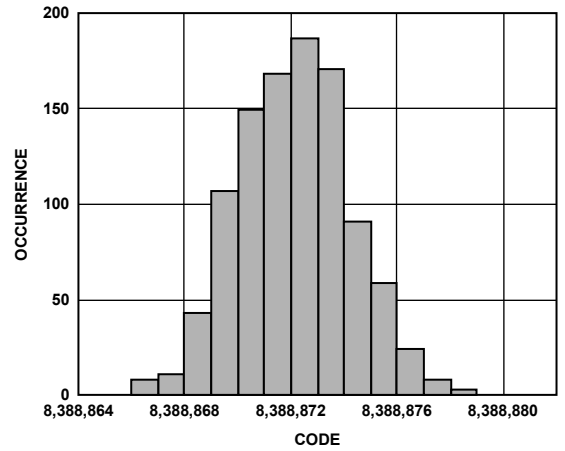

Figure 12. Noise Distribution Histogram ($V_{REF} = AV_{DD} = 5\text{ V}$, Output Data Rate = 42.1 Hz (FS[9:0] = 6, Average by 16), Gain = 1, Chop Disabled, Sinc⁴ Filter)

08387-011

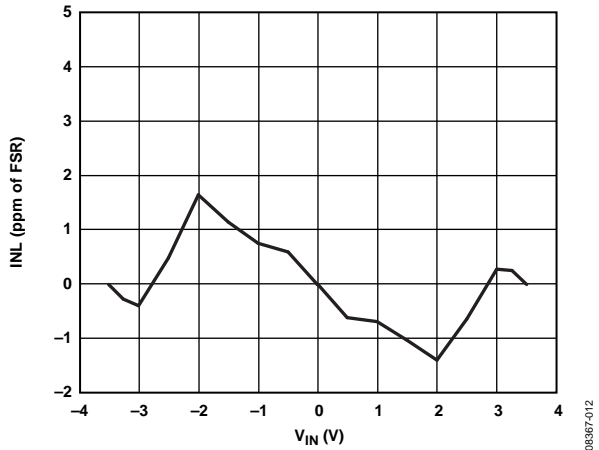

Figure 13. INL (Gain = 1)

08367-012

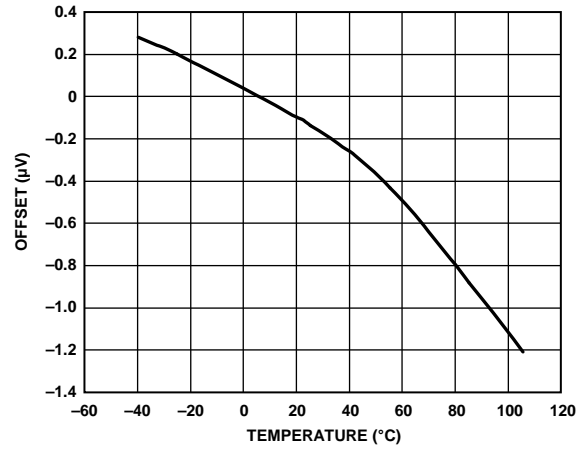

Figure 16. Offset vs. Temperature (Gain = 128, Chop Disabled)

08367-015

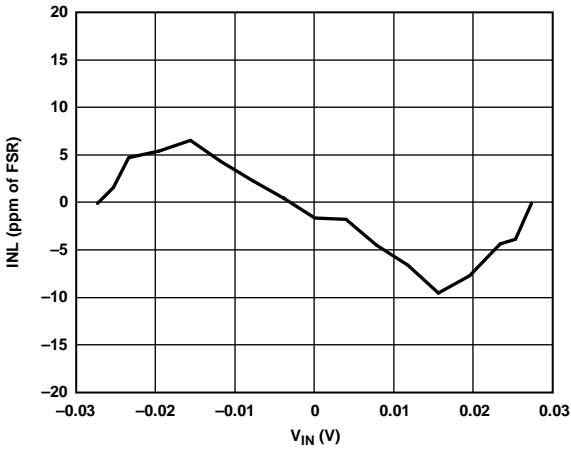

Figure 14. INL (Gain = 128)

08367-013

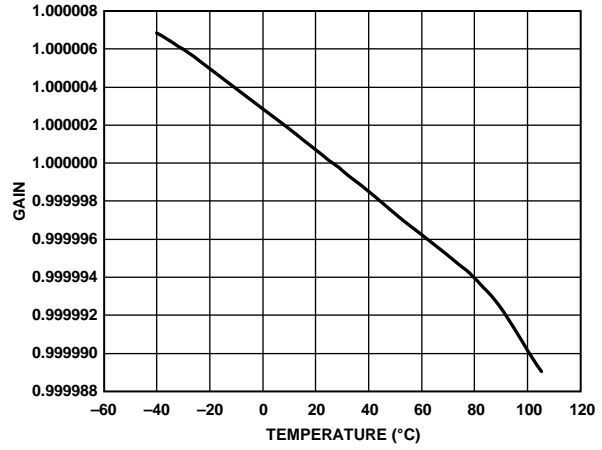

Figure 17. Gain vs. Temperature (Gain = 1)

08367-016

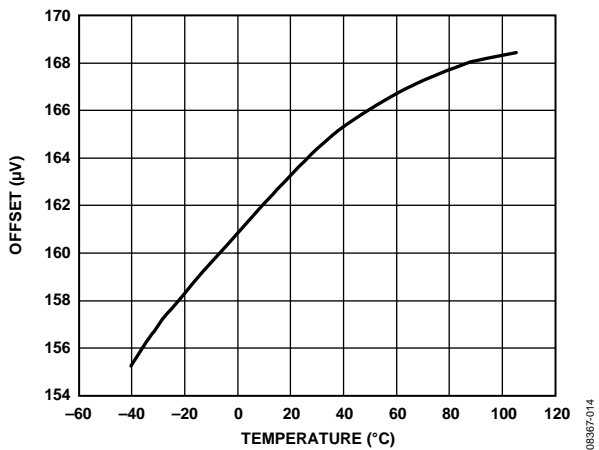

Figure 15. Offset vs. Temperature (Gain = 1, Chop Disabled)

08367-014

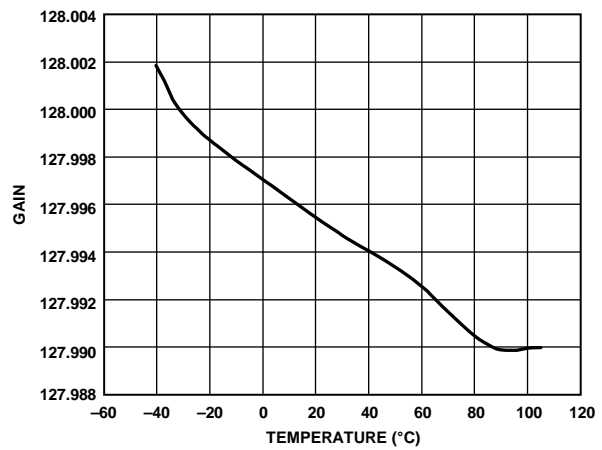

Figure 18. Gain vs. Temperature (Gain = 128)

08367-017

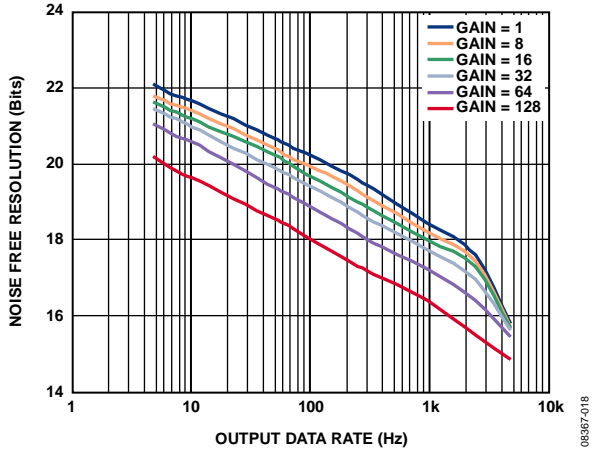

Figure 19. Noise Free Resolution ($Sinc^4$ Filter, Chop Disabled, $V_{REF} = 5 V$)

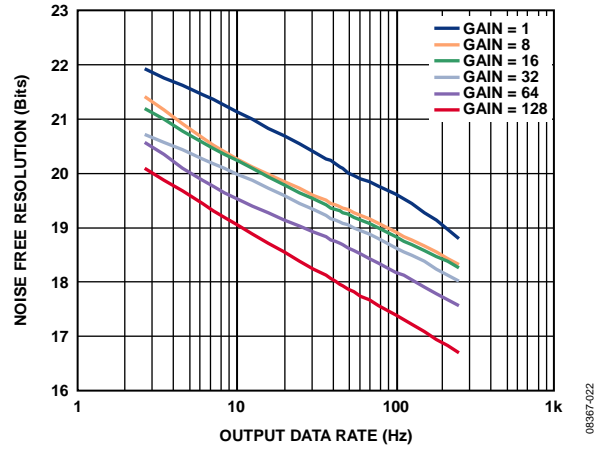

Figure 21. Noise Free Resolution in Fast Settling Mode ($V_{REF} = 5 V$, Averaging by 16, $Sinc^4$ Filter, Chop Disabled)

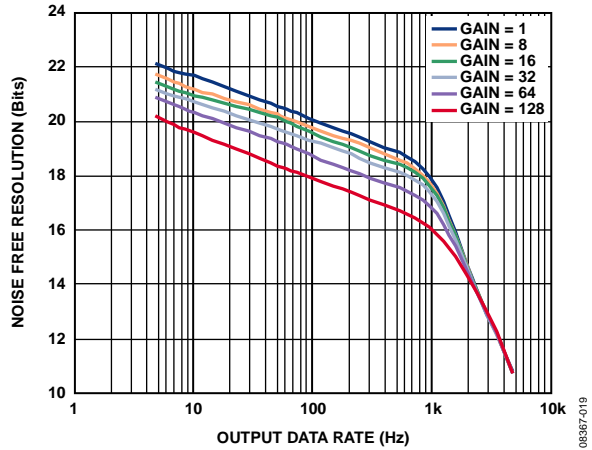

Figure 20. Noise Free Resolution ($Sinc^3$ Filter, Chop Disabled, $V_{REF} = 5 V$)

RMS NOISE AND RESOLUTION

The following tables show the rms noise, peak-to-peak noise, effective resolution, and noise free (peak-to-peak) resolution of the AD7193 for various output data rates and gain settings with chop disabled for the sinc⁴ and sinc³ filters and for fast settling mode. The numbers given are for the bipolar input range with an external 5 V reference. These numbers are typical and are generated with a differential input voltage of 0 V when the ADC

is continuously converting on a single channel. It is important to note that the effective resolution is calculated using the rms noise, whereas the peak-to-peak resolution is calculated based on peak-to-peak noise. The peak-to-peak resolution represents the resolution for which there is no code flicker. With chop enabled, the resolution improves by 0.5 bits.

SINC⁴ CHOP DISABLED

Table 7. RMS Noise (nV) vs. Gain and Output Data Rate

| Filter Word (Decimal) | Output Data Rate (Hz) | Settling Time (ms) | Gain of | | | | | |
|-----------------------|-----------------------|--------------------|---------|------|------|-----|-----|-----|
| | | | 1 | 8 | 16 | 32 | 64 | 128 |
| 1023 | 4.7 | 852.5 | 340 | 53 | 34 | 18 | 12 | 11 |
| 640 | 7.5 | 533 | 410 | 67 | 40 | 24 | 14 | 13 |
| 480 | 10 | 400 | 460 | 76 | 45 | 28 | 16 | 15 |
| 96 | 50 | 80 | 950 | 150 | 80 | 50 | 37 | 31 |
| 80 | 60 | 66.7 | 1000 | 160 | 90 | 54 | 40 | 35 |
| 32 | 150 | 26.7 | 1600 | 250 | 140 | 83 | 63 | 55 |
| 16 | 300 | 13.3 | 2300 | 340 | 190 | 120 | 90 | 79 |
| 5 | 960 | 4.17 | 4200 | 610 | 350 | 210 | 160 | 140 |
| 2 | 2400 | 1.67 | 7100 | 1000 | 570 | 350 | 260 | 230 |
| 1 | 4800 | 0.83 | 26,000 | 3400 | 1700 | 910 | 530 | 380 |

Table 8. Peak-to-Peak Noise (nV) vs. Gain and Output Data Rate

| Filter Word (Decimal) | Output Data Rate (Hz) | Settling Time (ms) | Gain of | | | | | |
|-----------------------|-----------------------|--------------------|---------|--------|--------|------|------|------|
| | | | 1 | 8 | 16 | 32 | 64 | 128 |
| 1023 | 4.7 | 852.5 | 2200 | 340 | 190 | 110 | 70 | 65 |
| 640 | 7.5 | 533 | 2700 | 410 | 230 | 130 | 90 | 85 |
| 480 | 10 | 400 | 3000 | 450 | 260 | 150 | 100 | 95 |
| 96 | 50 | 80 | 6000 | 890 | 500 | 320 | 230 | 200 |
| 80 | 60 | 66.7 | 6600 | 1000 | 560 | 350 | 250 | 220 |
| 32 | 150 | 26.7 | 10,000 | 1500 | 920 | 540 | 400 | 370 |
| 16 | 300 | 13.3 | 14,000 | 2200 | 1300 | 800 | 600 | 530 |
| 5 | 960 | 4.17 | 28,000 | 4100 | 2400 | 1400 | 1000 | 900 |
| 2 | 2400 | 1.67 | 49,000 | 7000 | 3800 | 2400 | 1800 | 1700 |
| 1 | 4800 | 0.83 | 175,000 | 23,000 | 12,000 | 6100 | 3500 | 2600 |

Table 9. Effective Resolution (Peak-to-Peak Resolution) vs. Gain and Output Data Rate

| Filter Word (Decimal) | Output Data Rate (Hz) | Settling Time (ms) | Gain of ¹ | | | | | |
|-----------------------|-----------------------|--------------------|----------------------|-------------|-------------|-------------|-------------|-------------|
| | | | 1 | 8 | 16 | 32 | 64 | 128 |
| 1023 | 4.7 | 852.5 | 24 (22.1) | 24 (21.8) | 24 (21.6) | 24 (21.4) | 23.6 (21.1) | 22.8 (20.2) |
| 640 | 7.5 | 533 | 24 (21.8) | 24 (21.5) | 23.9 (21.4) | 23.6 (21.2) | 23.4 (20.7) | 22.5 (19.8) |
| 480 | 10 | 400 | 24 (21.7) | 24 (21.4) | 23.7 (21.2) | 23.4 (21) | 23.2 (20.6) | 22.3 (19.6) |
| 96 | 50 | 80 | 23.3 (20.7) | 23 (20.4) | 22.9 (20.3) | 22.6 (19.9) | 22 (19.4) | 21.3 (18.6) |
| 80 | 60 | 66.7 | 23.3 (20.5) | 22.9 (20.3) | 22.8 (20.1) | 22.5 (19.8) | 21.9 (19.3) | 21.1 (18.4) |
| 32 | 150 | 26.7 | 22.6 (19.9) | 22.3 (19.7) | 22.1 (19.4) | 21.8 (19.1) | 21.2 (18.6) | 20.4 (17.7) |
| 16 | 300 | 13.3 | 22.1 (19.4) | 21.8 (19.1) | 21.6 (18.9) | 21.3 (18.6) | 20.7 (18) | 19.9 (17.2) |
| 5 | 960 | 4.17 | 21.2 (18.4) | 21 (18.2) | 20.8 (18) | 20.5 (17.8) | 19.9 (17.3) | 19.1 (16.4) |
| 2 | 2400 | 1.67 | 20.4 (17.6) | 20.3 (17.4) | 20.1 (17.3) | 19.8 (17) | 19.2 (16.4) | 18.4 (15.5) |
| 1 | 4800 | 0.83 | 18.6 (15.8) | 18.5 (15.7) | 18.5 (15.7) | 18.4 (15.6) | 18.2 (15.4) | 17.6 (14.9) |

¹ The output peak-to-peak (p-p) resolution is listed in parentheses.

SINC³ CHOP DISABLED

Table 10. RMS Noise (nV) vs. Gain and Output Data Rate

| Filter Word (Decimal) | Output Data Rate (Hz) | Settling Time (ms) | Gain of | | | | | |
|-----------------------|-----------------------|--------------------|---------|---------|--------|--------|--------|------|
| | | | 1 | 8 | 16 | 32 | 64 | 128 |
| 1023 | 4.7 | 639.4 | 340 | 58 | 35 | 20 | 13 | 11 |
| 640 | 7.5 | 400 | 410 | 72 | 41 | 25 | 16 | 14 |
| 480 | 10 | 300 | 490 | 90 | 45 | 28 | 18 | 16 |
| 96 | 50 | 60 | 1000 | 160 | 85 | 54 | 38 | 34 |
| 80 | 60 | 50 | 1100 | 170 | 95 | 59 | 41 | 37 |
| 32 | 150 | 20 | 1700 | 260 | 150 | 88 | 66 | 59 |
| 16 | 300 | 10 | 2400 | 350 | 200 | 130 | 94 | 85 |
| 5 | 960 | 3.13 | 6400 | 870 | 470 | 270 | 190 | 160 |
| 2 | 2400 | 1.25 | 115,000 | 14,000 | 7000 | 3600 | 1800 | 950 |
| 1 | 4800 | 0.625 | 860,000 | 110,000 | 54,000 | 27,000 | 14,000 | 7000 |

Table 11. Peak-to-Peak Noise (nV) vs. Gain and Output Data Rate

| Filter Word (Decimal) | Output Data Rate (Hz) | Settling Time (ms) | Gain of | | | | | |
|-----------------------|-----------------------|--------------------|-----------|---------|---------|---------|--------|--------|
| | | | 1 | 8 | 16 | 32 | 64 | 128 |
| 1023 | 4.7 | 639.4 | 2200 | 350 | 220 | 130 | 80 | 65 |
| 640 | 7.5 | 400 | 2700 | 450 | 270 | 160 | 100 | 88 |
| 480 | 10 | 300 | 3000 | 520 | 310 | 180 | 120 | 100 |
| 96 | 50 | 60 | 6400 | 990 | 540 | 370 | 250 | 230 |
| 80 | 60 | 50 | 7000 | 1100 | 610 | 390 | 270 | 250 |
| 32 | 150 | 20 | 11,000 | 1700 | 980 | 580 | 440 | 390 |
| 16 | 300 | 10 | 16,000 | 2300 | 1400 | 860 | 630 | 560 |
| 5 | 960 | 3.13 | 40,000 | 5700 | 3100 | 1800 | 1300 | 1100 |
| 2 | 2400 | 1.25 | 730,000 | 93,000 | 47,000 | 24,000 | 12,000 | 6100 |
| 1 | 4800 | 0.625 | 5,700,000 | 730,000 | 360,000 | 180,000 | 93,000 | 45,000 |

Table 12. Effective Resolution (Peak-to-Peak Resolution) vs. Gain and Output Data Rate

| Filter Word (Decimal) | Output Data Rate (Hz) | Settling Time (ms) | Gain of ¹ | | | | | |
|-----------------------|-----------------------|--------------------|----------------------|-------------|-------------|-------------|-------------|-------------|
| | | | 1 | 8 | 16 | 32 | 64 | 128 |
| 1023 | 4.7 | 639.4 | 24 (22.1) | 24 (21.8) | 24 (21.4) | 23.9 (21.2) | 23.5 (20.9) | 22.8 (20.2) |
| 640 | 7.5 | 400 | 24 (21.8) | 24 (21.4) | 23.9 (21.1) | 23.6 (20.9) | 23.2 (20.6) | 22.4 (19.8) |
| 480 | 10 | 300 | 24 (21.7) | 23.8 (21.2) | 23.7 (20.9) | 23.4 (20.7) | 23 (20.3) | 22.2 (19.6) |
| 96 | 50 | 60 | 23.3 (20.6) | 22.9 (20.3) | 22.9 (20.1) | 22.5 (19.7) | 22 (19.3) | 21.1 (18.4) |
| 80 | 60 | 50 | 23.1 (20.4) | 22.8 (20.1) | 22.7 (20) | 22.3 (19.6) | 21.9 (19.1) | 21 (18.3) |
| 32 | 150 | 20 | 22.5 (19.8) | 22.2 (19.5) | 22 (19.3) | 21.8 (19) | 21.2 (18.4) | 20.3 (17.6) |
| 16 | 300 | 10 | 22 (19.3) | 21.8 (19.1) | 21.6 (18.8) | 21.2 (18.5) | 20.7 (17.9) | 19.8 (17.1) |
| 5 | 960 | 3.13 | 20.6 (17.9) | 20.5 (17.7) | 20.3 (17.6) | 20.1 (17.4) | 19.6 (16.9) | 18.9 (16.1) |
| 2 | 2400 | 1.25 | 16.5 (13.7) | 16.4 (13.7) | 16.4 (13.7) | 16.4 (13.7) | 16.4 (13.7) | 16.4 (13.6) |
| 1 | 4800 | 0.625 | 13.5 (10.8) | 13.5 (10.7) | 13.5 (10.7) | 13.5 (10.7) | 13.5 (10.7) | 13.5 (10.7) |

¹ The output peak-to-peak (p-p) resolution is listed in parentheses.

FAST SETTLING

Table 13. RMS Noise (nV) vs. Gain and Output Data Rate

| Filter Word (Decimal) | Average | Output Data Rate (Hz) | Settling Time (ms) | Gain of | | | | | |
|--------------------------|---------|--------------------------|-----------------------|---------|-----|-----|-----|-----|-----|
| | | | | 1 | 8 | 16 | 32 | 64 | 128 |
| 96 | 16 | 2.63 | 380 | 380 | 87 | 52 | 33 | 15 | 11 |
| 30 | 16 | 8.4 | 118.75 | 620 | 140 | 71 | 43 | 30 | 21 |
| 6 | 16 | 42.10 | 23.75 | 1300 | 270 | 150 | 82 | 56 | 47 |
| 5 | 16 | 50.53 | 19.79 | 1500 | 280 | 160 | 88 | 61 | 50 |
| 2 | 16 | 126.32 | 7.92 | 2300 | 380 | 210 | 130 | 88 | 77 |
| 1 | 16 | 252.63 | 3.96 | 3400 | 520 | 290 | 180 | 130 | 110 |

Table 14. Peak-to-Peak Noise (nV) vs. Gain and Output Data Rate

| Filter Word (Decimal) | Average | Output Data Rate (Hz) | Settling Time (ms) | Gain of | | | | | |
|--------------------------|---------|--------------------------|-----------------------|---------|------|------|------|-----|-----|
| | | | | 1 | 8 | 16 | 32 | 64 | 128 |
| 96 | 16 | 2.63 | 380 | 2500 | 450 | 260 | 180 | 100 | 70 |
| 30 | 16 | 8.4 | 118.75 | 4000 | 900 | 470 | 280 | 190 | 130 |
| 6 | 16 | 42.10 | 23.75 | 8500 | 1800 | 950 | 540 | 360 | 300 |
| 5 | 16 | 50.53 | 19.79 | 9500 | 1900 | 1000 | 580 | 390 | 330 |
| 2 | 16 | 126.32 | 7.92 | 14,000 | 2800 | 1500 | 850 | 580 | 510 |
| 1 | 16 | 252.63 | 3.96 | 22,000 | 3800 | 2000 | 1200 | 820 | 740 |

Table 15. Effective Resolution (Peak-to-Peak Resolution) vs. Gain and Output Data Rate

| Filter Word (Decimal) | Average | Output Data Rate (Hz) | Settling Time (ms) | Gain of ¹ | | | | | |
|--------------------------|---------|--------------------------|-----------------------|----------------------|-------------|-------------|-------------|-------------|-------------|
| | | | | 1 | 8 | 16 | 32 | 64 | 128 |
| 96 | 16 | 2.63 | 380 | 24 (21.9) | 23.8 (21.4) | 23.5 (21.2) | 23.2 (20.7) | 23.2 (20.6) | 22.8 (20.1) |
| 30 | 16 | 8.4 | 118.75 | 23.9 (21.3) | 23.6 (20.4) | 23.1 (20.3) | 22.8 (20.1) | 22.3 (19.6) | 21.8 (19.2) |
| 6 | 16 | 42.10 | 23.75 | 22.9 (20.2) | 22.1 (19.4) | 22 (19.3) | 21.9 (19.1) | 21.4 (18.7) | 20.7 (18) |
| 5 | 16 | 50.53 | 19.79 | 22.7 (20) | 22.1 (19.3) | 21.9 (19.3) | 21.8 (19) | 21.3 (18.6) | 20.6 (17.9) |
| 2 | 16 | 126.32 | 7.92 | 22.1 (19.4) | 21.6 (18.8) | 21.5 (18.7) | 21.2 (18.5) | 20.8 (18) | 20 (17.2) |
| 1 | 16 | 252.63 | 3.96 | 21.5 (18.8) | 21.2 (18.3) | 21 (18.3) | 20.7 (18) | 20.2 (17.5) | 19.4 (16.7) |

¹ The output peak-to-peak (p-p) resolution is listed in parentheses.

ON-CHIP REGISTERS

The ADC is controlled and configured via a number of on-chip registers that are described on the following pages wherein the term set implies a Logic 1 state and the term cleared implies a Logic 0 state, unless otherwise noted.

Table 16. Register Summary

| Register | Addr. | Dir. | Default | Bit 7 | Bit 6 | Bit 5 | Bit 4 | Bit 3 | Bit 2 | Bit 1 | Bit 0 |
|----------------|-------|------|---------|-------------|--------|------------------|---------|--------|--------|-------|-----------|
| Communications | 00 | W | 00 | WEN | R/W | Register address | | | CREAD | 0 | 0 |
| Status | 00 | R | 80 | RDY | ERR | NOREF | Parity | CHD3 | CHD2 | CHD1 | CHD0 |
| Mode | 01 | R/W | 080060 | Mode select | | | DAT_STA | CLK1 | CLK0 | AVG1 | AVG0 |
| | | | | SINC3 | 0 | ENPAR | CLK_DIV | Single | REJ60 | FS9 | FS8 |
| | | | | FS7 | FS6 | FS5 | FS4 | FS3 | FS2 | FS1 | FS0 (LSB) |
| Configuration | 02 | R/W | 000117 | Chop (MSB) | 0 | 0 | REFSEL | 0 | Pseudo | Short | TEMP |
| | | | | CH7 | CH6 | CH5 | CH4 | CH3 | CH2 | CH1 | CH0 |
| | | | | Burn | REFDET | 0 | BUF | U/B | G2 | G1 | G0 (LSB) |
| Data | 03 | R | 000000 | D23 (MSB) | D22 | D21 | D20 | D19 | D18 | D17 | D16 |
| | | | | D15 | D14 | D13 | D12 | D11 | D10 | D9 | D8 |
| | | | | D7 | D6 | D5 | D4 | D3 | D2 | D1 | D0 (LSB) |
| ID | 04 | R | X2 | X | X | X | X | 0 | 0 | 1 | 0 |
| GPOCON | 05 | R/W | 00 | 0 | BPDSW | GP32EN | GP10EN | P3DAT | P2DAT | P1DAT | PODAT |
| Offset | 06 | R/W | 800000 | OF23 (MSB) | OF22 | OF21 | OF20 | OF19 | OF18 | OF17 | OF16 |
| | | | | OF15 | OF14 | OF13 | OF12 | OF11 | OF10 | OF9 | OF8 |
| | | | | OF7 | OF6 | OF5 | OF4 | OF3 | OF2 | OF1 | OF0 (LSB) |
| Full Scale | 07 | R/W | 5XXXX0 | FS23 (MSB) | FS22 | FS21 | FS20 | FS19 | FS18 | FS17 | FS16 |
| | | | | FS15 | FS14 | FS13 | FS12 | FS11 | FS10 | FS9 | FS8 |
| | | | | FS7 | FS6 | FS5 | FS4 | FS3 | FS2 | FS1 | FS0 (LSB) |

COMMUNICATIONS REGISTER**RS2, RS1, RS0 = 000**

The communications register is an 8-bit write-only register. All communications to the part must start with a write operation to the communications register. The data written to the communications register determine whether the next operation is a read or write operation and in which register this operation occurs. For read or write operations, when the subsequent read or write operation to the selected register is complete, the interface returns to where it expects a write operation to the communications register. This is the default state of the interface and, on power-up or after

a reset, the ADC is in this default state waiting for a write operation to the communications register. In situations where the interface sequence is lost, a write operation of at least 40 serial clock cycles with DIN high returns the ADC to this default state by resetting the entire part. Table 17 outlines the bit designations for the communications register. CR0 through CR7 indicate the bit location, CR denoting that the bits are in the communications register. CR7 denotes the first bit of the data stream. The number in parentheses indicates the power-on/reset default status of that bit.

| CR7 | CR6 | CR5 | CR4 | CR3 | CR2 | CR1 | CR0 |
|--------|--------|--------|--------|--------|----------|------|------|
| WEN(0) | R/W(0) | RS2(0) | RS1(0) | RS0(0) | CREAD(0) | 0(0) | 0(0) |

Table 17. Communications Register (CR) Bit Designations

| Bit Location | Bit Name | Description |
|--------------|------------|--|
| CR7 | WEN | Write enable bit. For a write to the communications register to occur, 0 must be written to this bit. If a 1 is the first bit written, the part does not clock onto subsequent bits in the register; rather, it stays at this bit location until a 0 is written to this bit. After a 0 is written to the WEN bit, the next seven bits are loaded to the communications register. Idling the DIN pin high between data transfers minimizes the effects of spurious SCLK pulses on the serial interface. |
| CR6 | R/W | 0 in this bit location indicates that the next operation is a write to a specified register. 1 in this bit position indicates that the next operation is a read from the designated register. |
| CR5 to CR3 | RS2 to RS0 | Register address bits. These address bits are used to select which registers of the ADC are selected during the serial interface communication (see Table 18). |
| CR2 | CREAD | Continuous read of the data register. When this bit is set to 1 (and the data register is selected), the serial interface is configured so that the data register can be continuously read; that is, the contents of the data register are automatically placed on the DOUT pin when the SCLK pulses are applied after the RDY pin goes low to indicate that a conversion is complete. The communications register does not have to be written to for subsequent data reads. To enable continuous read, Instruction 01011100 must be written to the communications register. To disable continuous read, Instruction 01011000 must be written to the communications register while the RDY pin is low. While continuous read is enabled, the ADC monitors activity on the DIN line so that it can receive the instruction to disable continuous read. Additionally, a reset occurs if 40 consecutive 1s occur on DIN; therefore, hold DIN low until an instruction is written to the device. |
| CR1 to CR0 | 0 | These bits must be programmed to Logic 0 for correct operation. |

Table 18. Register Selection

| RS2 | RS1 | RS0 | Register | Register Size |
|-----|-----|-----|---|-----------------|
| 0 | 0 | 0 | Communications register during a write operation | 8 bits |
| 0 | 0 | 0 | Status register during a read operation | 8 bits |
| 0 | 0 | 1 | Mode register | 24 bits |
| 0 | 1 | 0 | Configuration register | 24 bits |
| 0 | 1 | 1 | Data register/data register plus status information | 24 bits/32 bits |
| 1 | 0 | 0 | ID register | 8 bits |
| 1 | 0 | 1 | GPOCON register | 8 bits |
| 1 | 1 | 0 | Offset register | 24 bits |
| 1 | 1 | 1 | Full-scale register | 24 bits |

STATUS REGISTER**RS2, RS1, RS0 = 000; Power-On/Reset = 0x80**

The status register is an 8-bit read-only register. To access the ADC status register, the user must write to the communications register, select the next operation to be a read operation, and

load Bit RS2, Bit RS1, and Bit RS0 with 0. Table 19 outlines the bit designations for the status register. SR0 through SR7 indicate the bit locations, SR denoting that the bits are in the status register. SR7 denotes the first bit of the data stream. The number in parentheses indicates the power-on/reset default status of that bit.

| SR7 | SR6 | SR5 | SR4 | SR3 | SR2 | SR1 | SR0 |
|--------|--------|----------|-----------|---------|---------|---------|---------|
| RDY(1) | ERR(0) | NOREF(0) | Parity(0) | CHD3(0) | CHD2(0) | CHD1(0) | CHD0(0) |

Table 19. Status Register (SR) Bit Designations

| Bit Location | Bit Name | Description |
|--------------|--------------|---|
| SR7 | RDY | Ready bit for the ADC. This bit is cleared when data is written to the ADC data register. The RDY bit is set automatically after the ADC data register is read, or a period of time before the data register is updated, with a new conversion result to indicate to the user that the conversion data should not be read. It is also set when the part is placed in power-down mode or idle mode or when SYNC is taken low. The end of a conversion is also indicated by the DOUT/RDY pin. This pin can be used as an alternative to the status register for monitoring the ADC for conversion data. |
| SR6 | ERR | ADC error bit. This bit is written to at the same time as the RDY bit. This bit is set to indicate that the result written to the ADC data register is clamped to all 0s or all 1s. Error sources include overrange, underrange, or the absence of a reference voltage. This bit is cleared when the result written to the data register returns to within the allowed analog input range. The ERR bit is also set during calibrations if the reference source is invalid or if the applied analog input voltages are outside range during system calibrations. |
| SR5 | NOREF | No external reference bit. This bit is set to indicate that the selected reference (REFIN1 or REFIN2) is at a voltage that is below a specified threshold. When set, conversion results are clamped to all 1s. This bit is cleared to indicate that a valid reference is applied to the selected reference pins. The NOREF bit is enabled by setting the REFDET bit in the configuration register to 1. |
| SR4 | Parity | Parity check of the data register. If the ENPAR bit in the mode register is set and there is an odd number of 1s in the data register, the parity bit is set. It is cleared if there is an even number of 1s in the data register. The DAT_STA bit in the mode register should be set when the parity check is used. When the DAT_STA bit is set, the contents of the status register are transmitted along with the data for each data register read. |
| SR3 to SR0 | CHD3 to CHD0 | These bits indicate which channel corresponds to the data register contents. They do not indicate which channel is presently being converted but indicate which channel was selected when the conversion contained in the data register was generated. |

MODE REGISTER**RS2, RS1, RS0 = 001; Power-On/Reset = 0x080060**

The mode register is a 24-bit register from which data can be read or to which data can be written. This register is used to select the operating mode, the output data rate, and the clock source. Table 20 outlines the bit designations for the mode

register. MR0 through MR23 indicate the bit locations, MR denoting that the bits are in the mode register. MR23 denotes the first bit of the data stream. The number in parentheses indicates the power-on/reset default status of that bit. Any write to the mode register resets the modulator and filter and sets the RDY bit.

| | | | | | | | |
|-------------|-------------|-------------|-------------|-------------|-------------|-------------|-------------|
| MR23 | MR22 | MR21 | MR20 | MR19 | MR18 | MR17 | MR16 |
| MD2(0) | MD1(0) | MD0(0) | DAT_STA(0) | CLK1(1) | CLK0(0) | AVG1(0) | AVG0(0) |
| MR15 | MR14 | MR13 | MR12 | MR11 | MR10 | MR9 | MR8 |
| SINC3(0) | 0 | ENPAR(0) | CLK_DIV(0) | Single(0) | REJ60(0) | FS9(0) | FS8(0) |
| MR7 | MR6 | MR5 | MR4 | MR3 | MR2 | MR1 | MR0 |
| FS7(0) | FS6(1) | FS5(1) | FS4(0) | FS3(0) | FS2(0) | FS1(0) | FS0(0) |

Table 20. Mode Register (MR) Bit Designations

| Bit Location | Bit Name | Description | | | | | | | | | | | | | | | |
|--------------|------------|---|------|------|------------------|---|---|--|---|---|---|---|---|--|---|---|--|
| MR23 to MR21 | MD2 to MD0 | Mode select bits. These bits select the operating mode of the AD7193 (see Table 21). | | | | | | | | | | | | | | | |
| MR20 | DAT_STA | This bit enables the transmission of status register contents after each data register read. When DAT_STA is set, the contents of the status register are transmitted along with each data register read. This function is useful when several channels are selected because the status register identifies the channel to which the data register value corresponds. | | | | | | | | | | | | | | | |
| MR19, MR18 | CLK1, CLK0 | These bits select the clock source for the AD7193. Either the on-chip 4.92 MHz clock or an external clock can be used. The ability to use an external clock allows several AD7193 devices to be synchronized. Also, 50 Hz/60 Hz rejection is improved when an accurate external clock drives the AD7193. | | | | | | | | | | | | | | | |
| | | <table border="1"> <thead> <tr> <th>CLK1</th> <th>CLK0</th> <th>ADC Clock Source</th> </tr> </thead> <tbody> <tr> <td>0</td> <td>0</td> <td>External crystal. The external crystal is connected from MCLK1 to MCLK2.</td> </tr> <tr> <td>0</td> <td>1</td> <td>External clock. The external clock is applied to the MCLK2 pin.</td> </tr> <tr> <td>1</td> <td>0</td> <td>Internal 4.92 MHz clock. Pin MCLK2 is tristated.</td> </tr> <tr> <td>1</td> <td>1</td> <td>Internal 4.92 MHz clock. The internal clock is available on MCLK2.</td> </tr> </tbody> </table> | CLK1 | CLK0 | ADC Clock Source | 0 | 0 | External crystal. The external crystal is connected from MCLK1 to MCLK2. | 0 | 1 | External clock. The external clock is applied to the MCLK2 pin. | 1 | 0 | Internal 4.92 MHz clock. Pin MCLK2 is tristated. | 1 | 1 | Internal 4.92 MHz clock. The internal clock is available on MCLK2. |
| CLK1 | CLK0 | ADC Clock Source | | | | | | | | | | | | | | | |
| 0 | 0 | External crystal. The external crystal is connected from MCLK1 to MCLK2. | | | | | | | | | | | | | | | |
| 0 | 1 | External clock. The external clock is applied to the MCLK2 pin. | | | | | | | | | | | | | | | |
| 1 | 0 | Internal 4.92 MHz clock. Pin MCLK2 is tristated. | | | | | | | | | | | | | | | |
| 1 | 1 | Internal 4.92 MHz clock. The internal clock is available on MCLK2. | | | | | | | | | | | | | | | |
| MR17, MR16 | AVG1, AVG0 | Fast settling filter. When this option is selected, the settling time equals one conversion time. In fast settling mode, a first-order average and decimate block is included after the sinc filter. The data from the sinc filter is averaged by 2, 8, or 16. The averaging reduces the output data rate for a given FS word; however, the rms noise improves. The AVG1 and AVG0 bits select the amount of averaging. Fast settling mode can be used for FS words less than 512 only. When the sinc ³ filter is selected, the FS word must be less than 256 when averaging by 16. | | | | | | | | | | | | | | | |
| | | <table border="1"> <thead> <tr> <th>AVG1</th> <th>AVG0</th> <th>Average</th> </tr> </thead> <tbody> <tr> <td>0</td> <td>0</td> <td>No averaging (fast settling mode disabled)</td> </tr> <tr> <td>0</td> <td>1</td> <td>Average by 2</td> </tr> <tr> <td>1</td> <td>0</td> <td>Average by 8</td> </tr> <tr> <td>1</td> <td>1</td> <td>Average by 16</td> </tr> </tbody> </table> | AVG1 | AVG0 | Average | 0 | 0 | No averaging (fast settling mode disabled) | 0 | 1 | Average by 2 | 1 | 0 | Average by 8 | 1 | 1 | Average by 16 |
| AVG1 | AVG0 | Average | | | | | | | | | | | | | | | |
| 0 | 0 | No averaging (fast settling mode disabled) | | | | | | | | | | | | | | | |
| 0 | 1 | Average by 2 | | | | | | | | | | | | | | | |
| 1 | 0 | Average by 8 | | | | | | | | | | | | | | | |
| 1 | 1 | Average by 16 | | | | | | | | | | | | | | | |
| MR15 | SINC3 | Sinc ³ filter select bit. When this bit is cleared, the sinc ⁴ filter is used (default value). When this bit is set, the sinc ³ filter is used. The benefit of the sinc ³ filter compared to the sinc ⁴ filter is its lower settling time. For a given output data rate, f_{ADC} , the sinc ³ filter has a settling time of $3/f_{ADC}$ whereas the sinc ⁴ filter has a settling time of $4/f_{ADC}$ when chop is disabled. The sinc ⁴ filter, due to its deeper notches, gives better 50 Hz/60 Hz rejection. At low output data rates, both filters give similar rms noise and similar no missing codes for a given output data rate. At higher output data rates (FS values less than 5), the sinc ⁴ filter gives better performance than the sinc ³ filter for rms noise and no missing codes. | | | | | | | | | | | | | | | |
| MR14 | 0 | This bit must be programmed with a Logic 0 for correct operation. | | | | | | | | | | | | | | | |
| MR13 | ENPAR | Enable parity bit. When ENPAR is set, parity checking on the data register is enabled. The DAT_STA bit in the mode register should be set when the parity check is used. When the DAT_STA bit is set, the contents of the status register are transmitted along with the data for each data register read. | | | | | | | | | | | | | | | |

| Bit Location | Bit Name | Description |
|--------------|------------|---|
| MR12 | CLK_DIV | Clock divide-by-2. When CLK_DIV is set, the master clock is divided by 2. For normal conversions, set this bit to 0. When performing internal full-scale calibrations, this bit must be set when AV _{DD} is less than 4.75 V. The calibration accuracy is optimized when chop is enabled and a low output data rate is used while performing the calibration. When AV _{DD} is greater than or equal to 4.75 V, it is not compulsory to set the CLK_DIV bit when performing internal full-scale calibrations. |
| MR11 | Single | Single cycle conversion enable bit. When this bit is set, the AD7193 settles in one conversion cycle so that it functions as a zero latency ADC. This bit has no effect when multiple analog input channels are enabled or when the single conversion mode is selected. If the average + decimate filter is enabled, this bit (single) does not have an effect on the conversions unless chopping is also enabled. |
| MR10 | REJ60 | This bit enables a notch at 60 Hz when the first notch of the sinc filter is at 50 Hz. When REJ60 is set, a filter notch is placed at 60 Hz when the sinc filter first notch is at 50 Hz. This allows simultaneous 50 Hz/60 Hz rejection. |
| MR9 to MR0 | FS9 to FS0 | Filter output data rate select bits. The 10 bits of data programmed into these bits determine the filter cutoff frequency, the position of the first notch of the filter, and the output data rate for the part. In association with the gain selection, they also determine the output noise and, therefore, the effective resolution of the device (see Table 7 through Table 15). When chop is disabled, fast settling mode is disabled and continuous conversion mode is selected. $\text{Output Data Rate} = (\text{MCLK}/1024)/\text{FS}$ where FS is the decimal equivalent of the code in Bit FS0 to Bit FS9 within the range of 1 to 1023, and MCLK is the master clock frequency. With a nominal MCLK of 4.92 MHz, this results in an output data rate from 4.69 Hz to 4.8 kHz. With chop disabled and fast settling mode disabled, the first notch frequency is equal to the output data rate when converting on a single channel. When chop is enabled (fast settling mode disabled) $\text{Output Data Rate} = (\text{MCLK}/1024)/(N \times \text{FS})$ where FS is the decimal equivalent of the code in Bit FS0 to Bit FS9 within the range of 1 to 1023, and MCLK is the master clock frequency. With a nominal MCLK of 4.92 MHz, this results in a conversion rate from 4.69/N Hz to 4.8/N kHz, where N is the order of the sinc filter. The first notch frequency of the sinc filter is equal to $N \times \text{Output Data Rate}$ The chopping introduces notches at odd integer multiples of $\text{Output Data Rate}/2$ |

Table 21. Operating Modes (MD)

| MD2 | MD1 | MD0 | Mode |
|-----|-----|-----|---|
| 0 | 0 | 0 | Continuous conversion mode (default). In continuous conversion mode, the ADC continuously performs conversions and places the result in the data register. The DOUT/RDY pin and the RDY bit in the status register go low when a conversion is complete. The user can read these conversions by setting the CREAD bit in the communications register to 1, which enables continuous read. When continuous read is enabled, the conversions are automatically placed on the DOUT line when SCLK pulses are applied. Alternatively, the user can instruct the ADC to output each conversion by writing to the communications register. After power-on, a reset, or a reconfiguration of the ADC, the complete settling time of the filter is required to generate the first valid conversion. Subsequent conversions are available at the selected output data rate, which is dependent on filter choice. |
| 0 | 0 | 1 | Single conversion mode. When single conversion mode is selected, the ADC powers up and performs a single conversion on the selected channel. The internal clock requires up to 1 ms to power up and settle. The ADC then performs the conversion, which requires the complete settling time of the filter. The conversion result is placed in the data register. RDY goes low, and the ADC returns to power-down mode. The conversion remains in the data register until another conversion is performed. RDY remains active (low) until the data is read or another conversion is performed. |
| 0 | 1 | 0 | Idle mode. In idle mode, the ADC filter and modulator are held in a reset state even though the modulator clocks continue to be provided. |
| 0 | 1 | 1 | Power-down mode. In power-down mode, all AD7193 circuitry, except the bridge power-down switch, is powered down. The bridge power-down switch remains active because the user may need to power up the sensor prior to powering up the AD7193 for settling reasons. The external crystal, if selected, remains active. |

| MD2 | MD1 | MD0 | Mode |
|-----|-----|-----|--|
| 1 | 0 | 0 | Internal zero-scale calibration. An internal short is automatically connected to the input. $\overline{\text{RDY}}$ goes high when the calibration is initiated and returns low when the calibration is complete. The ADC is placed in idle mode following a calibration. The measured offset coefficient is placed in the offset register of the selected channel. |
| 1 | 0 | 1 | Internal full-scale calibration. A full-scale input voltage is automatically connected to the input for this calibration. $\overline{\text{RDY}}$ goes high when the calibration is initiated and returns low when the calibration is complete. The ADC is placed in idle mode following a calibration. The measured full-scale coefficient is placed in the full-scale register of the selected channel. A full-scale calibration is recommended each time that the gain of a channel is changed to minimize the full-scale error. When AV_{DD} is less than 4.75 V, the CLK_DIV bit must be set when performing the internal full-scale calibration. |
| 1 | 1 | 0 | System zero-scale calibration. The user should connect the system zero-scale input to the channel input pins as selected by the CH7 to CH0 bits in the configuration register. $\overline{\text{RDY}}$ goes high when the calibration is initiated and returns low when the calibration is complete. The ADC is placed in idle mode following a calibration. The measured offset coefficient is placed in the offset register of the selected channel. A system zero-scale calibration is recommended each time that the gain of a channel is changed. |
| 1 | 1 | 1 | System full-scale calibration. The user should connect the system full-scale input to the channel input pins as selected by the CH7 to CH0 bits in the configuration register. $\overline{\text{RDY}}$ goes high when the calibration is initiated and returns low when the calibration is complete. The ADC is placed in idle mode following a calibration. The measured full-scale coefficient is placed in the full-scale register of the selected channel. A full-scale calibration is recommended each time the gain of a channel is changed. |

CONFIGURATION REGISTER**RS2, RS1, RS0 = 010; Power-On/Reset = 0x000117**

The configuration register is a 24-bit register from which data can be read or to which data can be written. This register is used to configure the ADC for unipolar or bipolar mode, to enable or disable the buffer, to enable or disable the burnout currents, to select the gain, and to select the analog input channel.

Table 22 outlines the bit designations for the configuration register. CON0 through CON23 indicate the bit locations. CON denotes that the bits are in the configuration register. CON23 denotes the first bit of the data stream. The number in parentheses indicates the power-on/reset default status of that bit.

| | | | | | | | |
|--------------|--------------|--------------|--------------|------------------|--------------|--------------|--------------|
| CON23 | CON22 | CON21 | CON20 | CON19 | CON18 | CON17 | CON16 |
| Chop(0) | 0(0) | 0(0) | REFSEL(0) | 0(0) | Pseudo(0) | Short(0) | TEMP(0) |
| CON15 | CON14 | CON13 | CON12 | CON11 | CON10 | CON9 | CON8 |
| CH7(0) | CH6(0) | CH5(0) | CH4(0) | CH3(0) | CH2(0) | CH1(0) | CH0(1) |
| CON7 | CON6 | CON5 | CON4 | CON3 | CON2 | CON1 | CON0 |
| Burn(0) | REFDET(0) | 0(0) | BUF(1) | U/ \bar{B} (0) | G2(1) | G1(1) | G0(1) |

Table 22. Configuration Register (CON) Bit Designations

| Bit Location | Bit Name | Description | |
|---------------|--|--|---|
| CON23 | Chop | Chop enable bit. When the chop bit is cleared, chop is disabled. With chop disabled, higher conversion rates are allowed. For an FS word of 96 decimal and the sinc ⁴ filter selected, the conversion time is 20 ms and the settling time is 80 ms. However, at low gains, periodic calibrations may be required to remove the offset and offset drift. When the chop bit is set, chop is enabled. When chop is enabled, the offset and offset drift of the ADC are continuously removed. However, this increases the conversion time and settling time of the ADC. For example, when FS = 96 decimal and the sinc ⁴ filter is selected, the conversion time with chop enabled equals 80 ms and the settling time equals 160 ms. | |
| CON22, CON21 | 0 | These bits must be programmed with a Logic 0 for correct operation. | |
| CON20 | REFSEL | Reference select bits. The reference source for the ADC is selected using these bits. | |
| | | REFSEL | Reference Voltage |
| | | 0 | External reference applied between REFIN1(+) and REFIN1(-). |
| 1 | External reference applied between the P1/REFIN2(+) and P0/REFIN2(-) pins. | | |
| CON19 | 0 | This bit must be programmed with a Logic 0 for correct operation. | |
| CON18 | Pseudo | Pseudo differential analog inputs. The analog inputs can be configured as differential inputs or pseudo differential analog inputs. When the pseudo bit is set to 1, the AD7193 is configured to have eight pseudo differential analog inputs. When pseudo bit is set to 0, the AD7193 is configured to have four differential analog inputs. | |
| CON17 to CON8 | Short, TEMP, CH7 to CH0 | Channel select bits. These bits select which channels are enabled on the AD7193 (see Table 23 and Table 24). Several channels can be selected, and the AD7193 automatically sequences them. The conversion on each channel requires the complete settling time. When performing calibrations or when accessing the calibration registers, only one channel can be selected. | |
| CON7 | Burn | When this bit is set to 1, the 500 nA current sources in the signal path are enabled. When burn = 0, the burnout currents are disabled. The burnout currents can be enabled only when the buffer is active and when chop is disabled. | |
| CON6 | REFDET | Enables the reference detect function. When set, the NOREF bit in the status register indicates when the external reference being used by the ADC is open circuit or less than 0.6 V maximum. The reference detect circuitry operates only when the ADC is active. | |
| CON5 | 0 | This bit must be programmed with a Logic 0 for correct operation. | |

| Bit Location | Bit Name | Description | | | | | | | | | | | | | | | | | | | | | | | | | | | | | | | | | | | | | | | | | | | | | |
|--------------|--------------|--|----------|-----------------------------------|----|------|-----------------------------------|---|---|---|---|--------|---|---|---|----------|--|---|---|---|----------|--|---|---|---|---|-----------|---|---|---|----|-----------|---|---|---|----|------------|---|---|---|----|-----------|---|---|---|-----|-----------|
| CON4 | BUF | Enables the buffer on the analog inputs. If BUF is set, the analog inputs are buffered, allowing the user to place source impedances on the front end without contributing gain errors to the system. When the buffer is enabled, it requires some headroom; therefore, the voltage on any input pin must be limited to 250 mV within the power supply rails. If cleared, the analog inputs are unbuffered, lowering the power consumption of the device. With the buffer disabled, the voltage on the analog input pins can be from 50 mV below AGND to 50 mV above AV _{DD} . | | | | | | | | | | | | | | | | | | | | | | | | | | | | | | | | | | | | | | | | | | | | | |
| CON3 | U/ \bar{B} | Polarity select bit. When this bit is set, unipolar operation is selected. When this bit is cleared, bipolar operation is selected. | | | | | | | | | | | | | | | | | | | | | | | | | | | | | | | | | | | | | | | | | | | | | |
| CON2 to CON0 | G2 to G0 | Gain select bits. These bits are written by the user to select the ADC input range as follows: | | | | | | | | | | | | | | | | | | | | | | | | | | | | | | | | | | | | | | | | | | | | | |
| | | <table border="1"> <thead> <tr> <th>G2</th> <th>G1</th> <th>G0</th> <th>Gain</th> <th>ADC Input Range (2.5 V Reference)</th> </tr> </thead> <tbody> <tr> <td>0</td> <td>0</td> <td>0</td> <td>1</td> <td>±2.5 V</td> </tr> <tr> <td>0</td> <td>0</td> <td>1</td> <td>Reserved</td> <td></td> </tr> <tr> <td>0</td> <td>1</td> <td>0</td> <td>Reserved</td> <td></td> </tr> <tr> <td>0</td> <td>1</td> <td>1</td> <td>8</td> <td>±312.5 mV</td> </tr> <tr> <td>1</td> <td>0</td> <td>0</td> <td>16</td> <td>±156.2 mV</td> </tr> <tr> <td>1</td> <td>0</td> <td>1</td> <td>32</td> <td>±78.125 mV</td> </tr> <tr> <td>1</td> <td>1</td> <td>0</td> <td>64</td> <td>±39.06 mV</td> </tr> <tr> <td>1</td> <td>1</td> <td>1</td> <td>128</td> <td>±19.53 mV</td> </tr> </tbody> </table> | G2 | G1 | G0 | Gain | ADC Input Range (2.5 V Reference) | 0 | 0 | 0 | 1 | ±2.5 V | 0 | 0 | 1 | Reserved | | 0 | 1 | 0 | Reserved | | 0 | 1 | 1 | 8 | ±312.5 mV | 1 | 0 | 0 | 16 | ±156.2 mV | 1 | 0 | 1 | 32 | ±78.125 mV | 1 | 1 | 0 | 64 | ±39.06 mV | 1 | 1 | 1 | 128 | ±19.53 mV |
| G2 | G1 | G0 | Gain | ADC Input Range (2.5 V Reference) | | | | | | | | | | | | | | | | | | | | | | | | | | | | | | | | | | | | | | | | | | | |
| 0 | 0 | 0 | 1 | ±2.5 V | | | | | | | | | | | | | | | | | | | | | | | | | | | | | | | | | | | | | | | | | | | |
| 0 | 0 | 1 | Reserved | | | | | | | | | | | | | | | | | | | | | | | | | | | | | | | | | | | | | | | | | | | | |
| 0 | 1 | 0 | Reserved | | | | | | | | | | | | | | | | | | | | | | | | | | | | | | | | | | | | | | | | | | | | |
| 0 | 1 | 1 | 8 | ±312.5 mV | | | | | | | | | | | | | | | | | | | | | | | | | | | | | | | | | | | | | | | | | | | |
| 1 | 0 | 0 | 16 | ±156.2 mV | | | | | | | | | | | | | | | | | | | | | | | | | | | | | | | | | | | | | | | | | | | |
| 1 | 0 | 1 | 32 | ±78.125 mV | | | | | | | | | | | | | | | | | | | | | | | | | | | | | | | | | | | | | | | | | | | |
| 1 | 1 | 0 | 64 | ±39.06 mV | | | | | | | | | | | | | | | | | | | | | | | | | | | | | | | | | | | | | | | | | | | |
| 1 | 1 | 1 | 128 | ±19.53 mV | | | | | | | | | | | | | | | | | | | | | | | | | | | | | | | | | | | | | | | | | | | |

Table 23. Channel Selection (Pseudo Bit = 0)

| Channel Enable Bits in the Configuration Register | | | | | | | | | | Channel Enabled | | Status Register Bits CHD[3:0] | Calibration Register Pair |
|---|------|-----|-----|-----|-----|-----|-----|-----|-----|--|--|--|--|
| Short | TEMP | CH7 | CH6 | CH5 | CH4 | CH3 | CH2 | CH1 | CH0 | Positive Input AIN(+) | Negative Input AIN(-) | | |
| 1 | 1 | 1 | 1 | 1 | 1 | 1 | 1 | 1 | 1 | AIN1 AIN3 AIN5 AIN7 AIN1 AIN3 AIN5 AIN7 Temperature sensor AIN2 | AIN2 AIN4 AIN6 AIN8 AIN2 AIN4 AIN6 AIN8 AIN2 | 0000 0001 0010 0011 0100 0101 0110 0111 1000 1001 | 0 1 2 3 0 1 2 3 0 0 |

Table 24. Channel Selection (Pseudo Bit = 1)

| Channel Enable Bits in the Configuration Register | | | | | | | | | | Channel Enabled | | Status Register Bits CHD[3:0] | Calibration Register Pair |
|---|------|-----|-----|-----|-----|-----|-----|-----|-----|--|--|--|--|
| Short | TEMP | CH7 | CH6 | CH5 | CH4 | CH3 | CH2 | CH1 | CH0 | Positive Input AIN(+) | Negative Input AIN(-) | | |
| 1 | 1 | 1 | 1 | 1 | 1 | 1 | 1 | 1 | 1 | AIN1 AIN2 AIN3 AIN4 AIN5 AIN6 AIN7 AIN8 Temperature sensor AINCOM | AINCOM AINCOM AINCOM AINCOM AINCOM AINCOM AINCOM AINCOM AINCOM AINCOM | 0000 0001 0010 0011 0100 0101 0110 0111 1000 1001 | 0 1 2 3 4 4 4 4 0 0 |

DATA REGISTER**RS2, RS1, RS0 = 011; Power-On/Reset = 0x000000**

The conversion result from the ADC is stored in this data register. This is a read-only, 24-bit register. Upon completion of a read operation from this register, the RDY pin/bit is set. When the DAT_STA bit in the mode register is set to 1, the contents of the status register are appended to each 24-bit conversion. This is advisable when several analog input channels are enabled because the four LSBs of the status register (CHD3 to CHD0) identify the channel from which the conversion originated.

ID REGISTER**RS2, RS1, RS0 = 100; Power-On/Reset = 0xX2**

The identification number for the AD7193 is stored in the ID register. This is a read-only register.

GPOCON REGISTER**RS2, RS1, RS0 = 101; Power-On/Reset = 0x00**

The GPOCON register is an 8-bit register from which data can be read or to which data can be written. This register is used to enable the general-purpose digital outputs.

Table 25 outlines the bit designations for the GPOCON register. GP0 through GP7 indicate the bit locations. GP denotes that the bits are in the GPOCON register. GP7 denotes the first bit of the data stream. The number in parentheses indicates the power-on/reset default status of that bit.

| GP7 | GP6 | GP5 | GP4 | GP3 | GP2 | GP1 | GP0 |
|------|----------|-----------|-----------|----------|----------|----------|----------|
| 0(0) | BPDSW(0) | GP32EN(0) | GP10EN(0) | P3DAT(0) | P2DAT(0) | P1DAT(0) | P0DAT(0) |

Table 25. GPOCON Register (GP) Bit Designations

| Bit Location | Bit Name | Description |
|--------------|----------|---|
| GP7 | 0 | This bit must be programmed with a Logic 0 for proper operation. |
| GP6 | BPDSW | Bridge power-down switch control bit. This bit is set by the user to close the bridge power-down switch BPDSW to AGND. The switch can sink up to 30 mA. The bit is cleared by the user to open the bridge power-down switch. When the ADC is placed in power-down mode, the bridge power-down switch remains active. |
| GP5 | GP32EN | Digital Output P3 and Digital Output P2 enable. When GP32EN is set, the P3 and P2 digital outputs are active. When GP32EN is cleared, the P3 and P2 pins are tristated, and the P3DAT and P2DAT bits are ignored. |
| GP4 | GP10EN | Digital Output P1 and Digital Output P0 enable. When GP10EN is set, the P1 and P0 digital outputs are active. The P1 and P0 pins can be used as a reference input to REFIN2 when the REFSEL bit in the configuration register is set to 1. When GP10EN is cleared, the P1 and P0 outputs are tristated, and the P1DAT and P0DAT bits are ignored. |
| GP3 | P3DAT | Digital Output P3. When GP32EN is set, the P3DAT bit sets the value of the P3 general-purpose output pin. When P3DAT is high, the P3 output pin is high. When P3DAT is low, the P3 output pin is low. When the GPOCON register is read, the P3DAT bit reflects the status of the P3 pin if GP32EN is set. |
| GP2 | P2DAT | Digital Output P2. When GP32EN is set, the P2DAT bit sets the value of the P2 general-purpose output pin. When P2DAT is high, the P2 output pin is high. When P2DAT is low, the P2 output pin is low. When the GPOCON register is read, the P2DAT bit reflects the status of the P2 pin if GP32EN is set. |
| GP1 | P1DAT | Digital Output P1. When GP10EN is set, the P1DAT bit sets the value of the P1 general-purpose output pin. When P1DAT is high, the P1 output pin is high. When P1DAT is low, the P1 output pin is low. When the GPOCON register is read, the P1DAT bit reflects the status of the P1 pin if GP10EN is set. |
| GP0 | P0DAT | Digital Output P0. When GP10EN is set, the P0DAT bit sets the value of the P0 general-purpose output pin. When P0DAT is high, the P0 output pin is high. When P0DAT is low, the P0 output pin is low. When the GPOCON register is read, the P0DAT bit reflects the status of the P0 pin if GP10EN is set. |

OFFSET REGISTER***RS2, RS1, RS0 = 110; Power-On/Reset = 0x800000***

The offset register holds the offset calibration coefficient for the ADC. The power-on reset value of the offset register is 0x800000. The AD7193 has five offset registers. In differential mode, each channel has a dedicated offset register. In pseudo differential mode, Channel AIN1, Channel AIN2, Channel AIN3, and Channel AIN4 have dedicated registers whereas the remaining channels share an offset register (see Table 23 and Table 24).

Each of these registers is a 24-bit read/write register. This register is used in conjunction with its associated full-scale register to form a register pair. The power-on reset value is automatically overwritten if an internal or system zero-scale calibration is initiated by the user. The AD7193 must be placed in power-down mode or idle mode when writing to the offset register.

FULL-SCALE REGISTER***RS2, RS1, RS0 = 111; Power-On/Reset = 0x5XXXX0***

The full-scale register is a 24-bit register that holds the full-scale calibration coefficient for the ADC. The AD7193 has five full-scale registers. In differential mode, each channel has a dedicated full-scale register. In pseudo differential mode, the AIN1, AIN2, AIN3, and AIN4 channels have dedicated registers whereas the remaining channels share a full-scale register (see Table 23 and Table 24).

The full-scale registers are read/write registers. However, when writing to the full-scale registers, the ADC must be placed in power-down mode or idle mode. These registers are configured at power-on with factory calibrated full-scale calibration coefficients, the calibration being performed at gain = 1. Therefore, every device has different default coefficients. The default value is automatically overwritten if an internal or system full-scale calibration is initiated by the user or if the full-scale register is written to.

ADC CIRCUIT INFORMATION

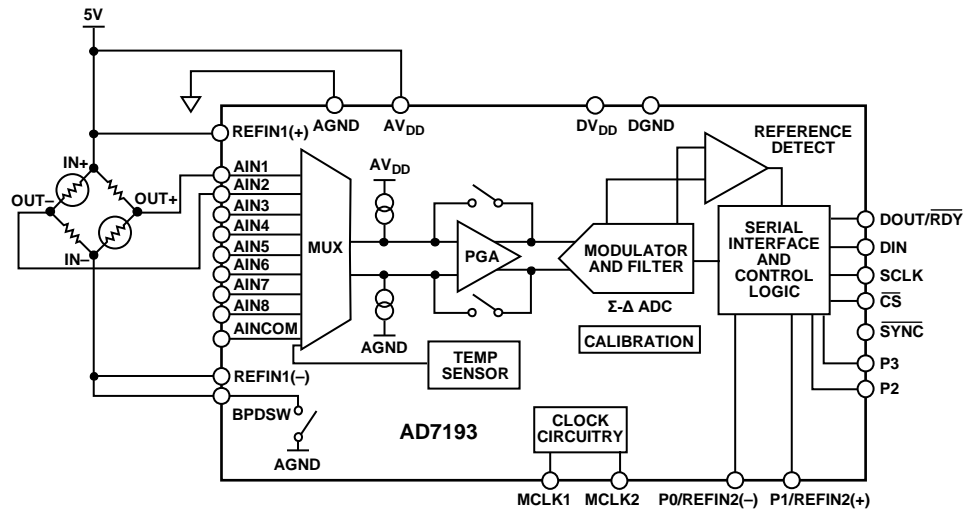

Figure 22. Basic Connection Diagram

08367-023

OVERVIEW

The AD7193 is an ultralow noise ADC that incorporates a Σ - Δ modulator, a buffer, PGA, and on-chip digital filtering intended for the measurement of wide dynamic range signals such as those in pressure transducers, weigh scales, and strain gage applications. Figure 22 shows the basic connections required to operate the part.

Analog Inputs

The device can be configured to have four differential or eight pseudo differential analog inputs. The analog inputs can be buffered or unbuffered.

Multiplexer

The on-chip multiplexer increases the channel count of the device. Because the multiplexer is included on chip, any channel changes are synchronized with the conversion process.

PGA

The analog input signal can be amplified using the PGA. The PGA allows gains of 1, 8, 16, 32, 64, and 128.

Reference Detect

The AD7193 is capable of monitoring the external reference. If the reference is not present, a flag is set in the status register of the device.

Burnout Currents

Two 500 nA burnout currents are included on-chip to detect the presence of the external sensor.

Sigma-Delta (Σ - Δ) ADC and Filter

The AD7193 contains a fourth-order Σ - Δ modulator followed by a digital filter. The device has several filter options

- Sinc⁴
- Sinc³
- Chop enabled/disabled
- Fast settling
- Zero latency

Serial Interface

The AD7193 has a 4-wire SPI interface. The on-chip registers are accessed via the serial interface.

Clock

The AD7193 has an internal 4.92 MHz clock. Either this clock or an external clock can be used as the clock source to the AD7193. The internal clock can also be made available on a pin if a clock source is required for external circuitry.

Bridge Power-Down Switch

External circuitry such as strain gages or bridges can be powered up/down using the bridge power-down switch.

Temperature Sensor

The on-chip temperature sensor monitors the die temperature.

Digital Outputs

The AD7193 has four general-purpose digital outputs. These can be used for driving external circuitry. For example, an external multiplexer can be controlled by these outputs.

Calibration

Both internal and system calibration are included on chip; therefore, the user has the option of removing offset/gain errors internal to the AD7193 only, or removing the offset/gain errors of the complete end system.

ANALOG INPUT CHANNEL

The AD7193 has four differential/eight pseudo differential analog input channels that can be buffered or unbuffered. In buffered mode (the BUF bit in the configuration register is set to 1), the input channel feeds into a high impedance input stage of the buffer amplifier. Therefore, the input can tolerate significant source impedances and is tailored for direct connection to external resistive type sensors such as strain gages or resistance temperature detectors (RTDs).

When BUF = 0, the part operates in unbuffered mode. This results in a higher analog input current. Note that this unbuffered input path provides a dynamic load to the driving source.

Therefore, resistor/capacitor combinations on the input pins can cause gain errors, depending on the output impedance of the source that is driving the ADC input. Table 26 shows the allowable external resistance/capacitance values for unbuffered mode at a gain of 1 such that no gain error at the 20-bit level is introduced.

Table 26. External RC Combination for No 20-Bit Gain Error

| C (pF) | R (Ω) |
|--------|----------------|
| 50 | 1.4 k |
| 100 | 850 |
| 500 | 300 |
| 1000 | 230 |
| 5000 | 30 |

The absolute input voltage range in buffered mode is restricted to a range between AGND + 250 mV and AV_{DD} – 250 mV. Care must be taken in setting up the common-mode voltage to not exceed these limits; otherwise, linearity and noise performance degrade.

The absolute input voltage in unbuffered mode includes the range between AGND – 50 mV and AV_{DD} + 50 mV. The negative absolute input voltage limit allows the possibility of monitoring small true bipolar signals with respect to AGND.

PROGRAMMABLE GAIN ARRAY (PGA)

When the gain stage is enabled, the output from the buffer is applied to the input of the PGA. The presence of the PGA means that signals of small amplitude can be gained within the AD7193 and still maintain excellent noise performance. For example, when the gain is set to 128, the rms noise is 11 nV, typically, when the output data rate is 4.7 Hz, which is equivalent to 22.7 bits of effective resolution or 20 bits of noise free resolution.

The AD7193 can be programmed to have a gain of 1, 8, 16, 32, 64, or 128 by using Bit 2 to Bit G0 in the configuration register. Therefore, with an external 2.5 V reference, the unipolar ranges are from 0 mV to 19.53 mV to 0 V to 2.5 V, and the bipolar ranges are from ± 19.53 mV to ± 2.5 V.

The analog input range must be limited to $\pm(AV_{DD} - 1.25 \text{ V})/\text{gain}$ because the PGA requires some headroom. Therefore, if V_{REF} = AV_{DD} = 5 V, the maximum analog input that can be applied to the AD7193 is 0 V to 3.75 V/gain in unipolar mode or ± 3.75 V/gain in bipolar mode.

REFERENCE

The ADC has a fully differential input capability for the reference channel. In addition, the user has the option of selecting one of two external reference options (REFIN1(\pm)) or REFIN2(\pm)). The reference source for the AD7193 is selected using the REFSEL bit in the configuration register. The REFIN2(\pm) pins are dual purpose: they can function as two general-purpose output pins or as reference pins. When the REFSEL bit is set to 1, these pins automatically function as reference pins.

The common-mode range for these differential inputs is from AGND to AV_{DD}. The reference voltage REFIN (REFINx(+)) – REFINx(–)) is AV_{DD} nominal, but the AD7193 is functional with reference voltages from 1 V to AV_{DD}. In applications where the excitation (voltage or current) for the transducer on the analog input also drives the reference voltage for the part, the effect of the low frequency noise in the excitation source is removed because the application is ratiometric. If the AD7193 is used in a nonratiometric application, a low noise reference should be used.

The reference input is unbuffered; therefore, excessive RC source impedances introduce gain errors. RC values similar to those in Table 26 are recommended for the reference inputs. Deriving the reference input voltage from an external resistor means that the reference input sees significant external source impedance. External decoupling on the REFINx pins is not recommended in this type of circuit configuration. Conversely, if large decoupling capacitors are used on the reference inputs, there should be no resistors in series with the reference inputs.

Recommended 2.5 V reference voltage sources for the AD7193 include the ADR421 and ADR431, which are low noise references. These references tolerate decoupling capacitors on REFINx(+) without introducing gain errors in the system. Figure 23 shows the recommended connections between the ADR421 and the AD7193.

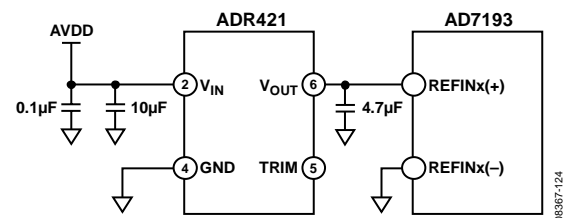

Figure 23. ADR421 to AD7193 Connections

REFERENCE DETECT

The AD7193 includes on-chip circuitry to detect whether the part has a valid reference for conversions or calibrations. This feature is enabled when the REFDET bit in the configuration register is set to 1. If the voltage between the selected REFINx(+) and REFINx(-) pins is less than 0.3 V, the AD7193 detects that it no longer has a valid reference. In this case, the NOREF bit of the status register is set to 1. When the voltage between the selected REFINx(+) and REFINx(-) pins is greater than 0.6 V, the AD7193 detects a valid reference so the NOREF bit is set to 0. The operation of the NOREF bit is undefined when the voltage between the selected REFINx(+) and REFINx(-) pins is between 0.3 V and 0.6 V.

If the AD7193 is performing normal conversions and the NOREF bit becomes active, the conversion result is all 1s. Therefore, it is not necessary to continuously monitor the status of the NOREF bit when performing conversions. It is only necessary to verify its status if the conversion result read from the ADC data register is all 1s.

If the AD7193 is performing either an offset or full-scale calibration and the NOREF bit becomes active, the updating of the respective calibration registers is inhibited to avoid loading incorrect coefficients to these registers, and the ERR bit in the status register is set. If the user is concerned about verifying that a valid reference is in place every time a calibration is performed, the status of the ERR bit should be checked at the end of the calibration cycle.

BIPOLAR/UNIPOLAR CONFIGURATION

The analog input to the AD7193 can accept either unipolar or bipolar input voltage ranges. A bipolar input range does not imply that the part can tolerate negative voltages with respect to system AGND. In pseudo differential mode, signals are referenced to AINCOM, whereas in differential mode, signals are referenced to the negative input of the differential pair. For example, if AINCOM is 2.5 V and the AD7193 AIN1 analog input is configured for unipolar mode with a gain of 2, the input voltage range on the AIN1 pin is 2.5 V to 3.75 V when a 2.5 V reference is used.

If AINCOM is 2.5 V and the AD7193 AIN1 analog input is configured for bipolar mode with a gain of 2, the analog input range on AIN1 is 1.25 V to 3.75 V. The bipolar/unipolar option is chosen by programming the $\overline{U/B}$ bit in the configuration register.

DATA OUTPUT CODING

When the ADC is configured for unipolar operation, the output code is natural (straight) binary with a zero differential input voltage resulting in a code of 000...000, a midscale voltage resulting in a code of 100...000, and a full-scale input voltage resulting in a code of 111...111. The output code for any analog input voltage can be represented as

$$Code = (2^N \times AIN \times Gain) / V_{REF}$$

When the ADC is configured for bipolar operation, the output code is offset binary with a negative full-scale voltage resulting in a code of 000...000, a zero differential input voltage resulting in a code of 100...000, and a positive full-scale input voltage resulting in a code of 111...111. The output code for any analog input voltage can be represented as

$$Code = 2^{N-1} \times [(AIN \times Gain / V_{REF}) + 1]$$

where:

AIN is the analog input voltage.

Gain is the PGA setting (1 to 128).

N = 24.

BURNOUT CURRENTS

The AD7193 contains two 500 nA constant current generators, one sourcing current from AV_{DD} to AIN(+) and one sinking current from AIN(-) to AGND. The currents are switched to the selected analog input pair. Both currents are either on or off, depending on the burnout current enable (burn) bit in the configuration register.

These currents can be used to verify that an external transducer remains operational before attempting to take measurements on that channel. After the burnout currents are turned on, they flow in the external transducer circuit, and a measurement of the input voltage on the analog input channel can be taken. It takes some time for the burnout currents to detect an open circuit condition because the currents must charge any external capacitors.

There are several reasons that a fault condition is detected: the front-end sensor may be either open circuit or overloaded, or the reference may be absent and the NOREF bit in the status register is set, thus clamping the data to all 1s. The user must check these three cases before making a determination.

If the voltage measured is 0 V, it may indicate that the transducer has short circuited. The current sources work over the normal absolute input voltage range specifications when the analog inputs are buffered and chop is disabled.

CHANNEL SEQUENCER

The AD7193 includes a channel sequencer, which simplifies communications with the device in multichannel applications. The sequencer also optimizes the channel throughput of the device because the sequencer switches channels at the optimum rate rather than waiting for instructions via the SPI interface.

Bit CH0 to Bit CH7 in the configuration register are used to enable the required analog input channels. The analog inputs must be configured for differential mode or pseudo differential mode using the pseudo bit in the configuration register. The temperature sensor is enabled using the TEMP bit in the configuration. An internal short can also be selected using the short bit in the configuration register.

In continuous conversion mode, the ADC selects each of the enabled channels in sequence and performs a conversion on the channel. The $\overline{\text{DOUT/RDY}}$ pin indicates when a valid conversion is available on each channel. When several channels are enabled, the contents of the status register should be attached to the 24-bit word allowing the user to identify the channel that corresponds to each conversion. The four LSBs of the status register indicate the channel to which the conversion corresponds. Table 23 and Table 24 show the channel options for differential mode and pseudo differential mode with the corresponding channel ID values in the status register. To attach the status register value to the conversion, Bit DAT_STA in the mode register should be set to 1.

When several channels are enabled, the ADC allows the complete filter settling time to generate a valid conversion each time the channel is changed. The AD7193 automatically takes care of this through the following sequence:

1. When a channel is selected, the modulator and filter are reset.
2. The AD7193 allows the complete settling time to generate a valid conversion.
3. $\overline{\text{DOUT/RDY}}$ indicates when a valid conversion is available.
4. The AD7193 selects the next enabled channel and converts on that channel.
5. The user can read the data register while the ADC is performing the conversion on the next channel.

The time required to read a valid conversion from all enabled channels is equal to

$$t_{\text{SETTLE}} \times \text{Number of Enabled Channels}$$

For example, if the sinc^4 filter is selected, chop is disabled, and zero latency is disabled, the settling time for each channel equals

$$t_{\text{SETTLE}} = 4/f_{\text{ADC}}$$

where f_{ADC} is the output data rate when continuously converting on a single channel.

Therefore, the time required to read all enabled channels is

$$(4 \times \text{Number of Enabled Channels})/f_{\text{ADC}}$$

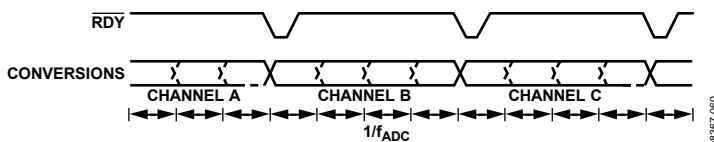

Figure 24. Channel Sequencer

DIGITAL INTERFACE

As indicated in the On-Chip Registers section, the programmable functions of the AD7193 are controlled using a set of on-chip registers. Data is written to these registers via the serial interface of the part. Read access to the on-chip registers is also provided by this interface.

All communication with the part must start with a write to the communications register. After power-on or reset, the device expects a write to its communications register. The data written to this register determines whether the next operation is a read operation or a write operation, and it determines to which register this read or write operation occurs. Therefore, write access to any of the other registers on the part begins with a write operation to the communications register, followed by a write to the selected register. A read operation from any other register (except when continuous read mode is selected) starts with a write to the communications register, followed by a read operation from the selected register.

The serial interface of the AD7193 consists of four signals: $\overline{\text{CS}}$, DIN , SCLK , and $\overline{\text{DOUT/RDY}}$. The DIN line is used to transfer data into the on-chip registers and $\overline{\text{DOUT/RDY}}$ is used for accessing data from the on-chip registers. SCLK is the serial clock input for the device, and all data transfers (either on DIN or $\overline{\text{DOUT/RDY}}$) occur with respect to the SCLK signal.

The $\overline{\text{DOUT/RDY}}$ pin also functions as a data-ready signal, the line going low when a new data-word is available in the output register. It is reset high when a read operation from the data register is complete. It also goes high prior to the updating of the data register to indicate when not to read from the device, to ensure that a data read is not attempted while the register is being updated. $\overline{\text{CS}}$ is used to select a device. It can be used to decode the AD7193 in systems where several components are connected to the serial bus.

Figure 3 and Figure 4 show timing diagrams for interfacing to the AD7193 using $\overline{\text{CS}}$ to decode the part. Figure 3 shows the timing for a read operation from the output shift register of the AD7193, and Figure 4 shows the timing for a write operation to the input shift register. It is possible to read the same word from the data register several times even though the $\overline{\text{DOUT/RDY}}$ line returns high after the first read operation. However, care must be taken to ensure that the read operations are completed before the next output update occurs. In continuous read mode, the data register can be read only once.

The serial interface can operate in 3-wire mode by tying $\overline{\text{CS}}$ low. In this case, the SCLK , DIN , and $\overline{\text{DOUT/RDY}}$ lines are used to communicate with the AD7193. The end of the conversion can be monitored using the RDY bit or pin. This scheme is suitable for interfacing to microcontrollers. If $\overline{\text{CS}}$ is required as a decoding signal, it can be generated from a port pin. For microcontroller interfaces, it is recommended that SCLK idle high between data transfers.

The AD7193 can be operated with \overline{CS} used as a frame synchronization signal. This scheme is useful for DSP interfaces. In this case, the first bit (MSB) is effectively clocked out by \overline{CS} because \overline{CS} normally occurs after the falling edge of SCLK in DSPs. The SCLK can continue to run between data transfers, provided the timing numbers are obeyed.

The serial interface can be reset by writing a series of 1s to the DIN input. If a Logic 1 is written to the AD7193 DIN line for at least 40 serial clock cycles, the serial interface is reset. This ensures that the interface can be reset to a known state if the interface is lost due to a software error or a glitch in the system. Reset returns the interface to the state in which it expects a write to the communications register. This operation resets the contents of all registers to their power-on values. Following a reset, the user should allow a period of 500 μ s before addressing the serial interface.

The AD7193 can be configured to continuously convert or to perform a single conversion (see Figure 25 through Figure 27).

Single Conversion Mode

In single conversion mode, the AD7193 is placed in power-down mode after conversions. When a single conversion is initiated by setting MD2 to 0, MD1 to 0, and MD0 to 1 in the mode register, the AD7193 powers up, performs a single conversion, and then returns to power-down mode. The on-chip oscillator requires 1 ms, approximately, to power up.

DOUT/RDY goes low to indicate the completion of a conversion. When the data-word has been read from the data register, DOUT/RDY goes high. If \overline{CS} is low, DOUT/RDY remains high until another conversion is initiated and completed. The data register can be read several times, if required, even when DOUT/RDY has gone high.

If several channels are enabled, the ADC sequences through the enabled channels and performs a conversion on each channel. When a conversion is started, DOUT/RDY goes high and remains high until a valid conversion is available. As soon as the conversion is available, DOUT/RDY goes low. The ADC then selects the next channel and begins a conversion. The user can read the present conversion while the next conversion is being performed. As soon as the next conversion is complete, the data register is updated; therefore, the user has a limited period in which to read the conversion. When the ADC has performed a single conversion on each of the selected channels, it returns to power-down mode.

If the DAT_STA bit in the mode register is set to 1, the contents of the status register are output along with the conversion each time that the data read is performed. The four LSBs of the status register indicate the channel to which the conversion corresponds.

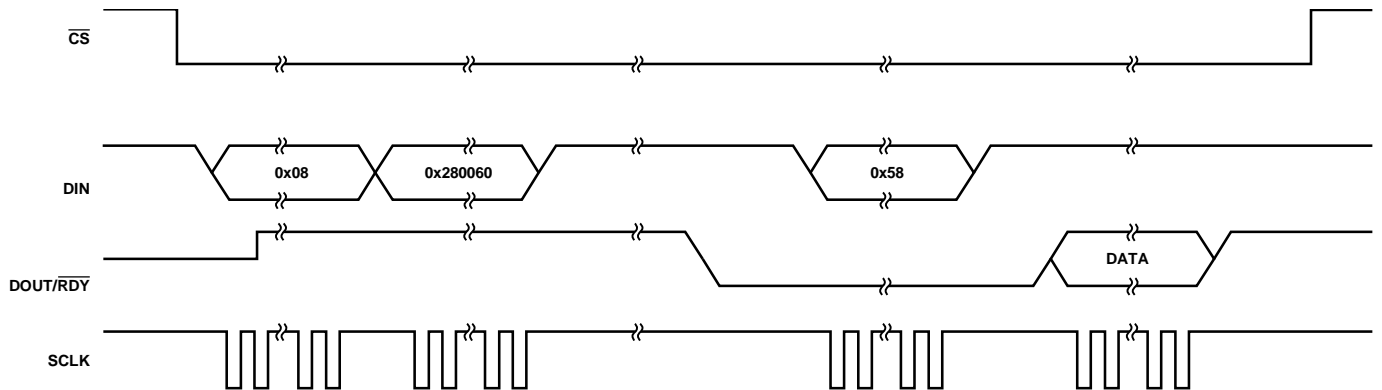

Figure 25. Single Conversion

Continuous Conversion Mode

Continuous conversion is the default power-up mode. The AD7193 converts continuously, and the RDY bit in the status register goes low each time a conversion is complete. If CS is low, the DOUT/RDY line also goes low when a conversion is completed. To read a conversion, the user writes to the communications register, indicating that the next operation is a read of the data register. When the data-word has been read from the data register, DOUT/RDY goes high. The user can read this register additional times, if required. However, the user must ensure that the data register is not being accessed at the completion of the next conversion or else the new conversion word is lost.

When several channels are enabled, the ADC continuously loops through the enabled channels, performing one conversion on each channel per loop. The data register is updated as soon as each conversion is available. The DOUT/RDY pin pulses low each time a conversion is available. The user can then read the conversion while the ADC converts on the next enabled channel.

If the DAT_STA bit in the mode register is set to 1, the contents of the status register are output along with the conversion each time that the data read is performed. The status register indicates the channel to which the conversion corresponds.

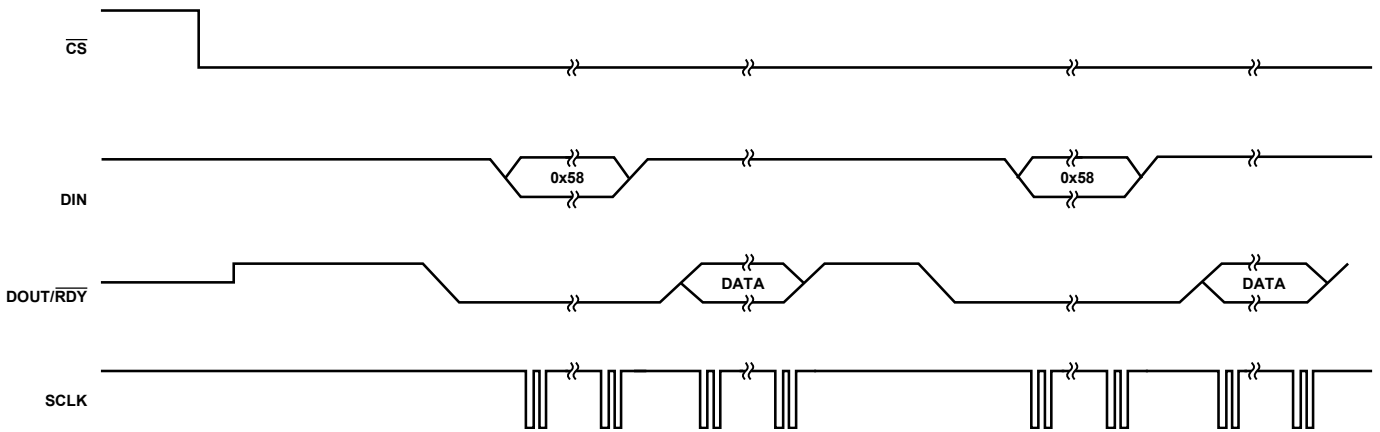

Figure 26. Continuous Conversion

08387-082

Continuous Read

Rather than write to the communications register each time a conversion is complete to access the data, the AD7193 can be configured so that the conversions are placed on the DOUT/RDY line automatically. By writing 01011100 to the communications register, the user need only apply the appropriate number of SCLK cycles to the ADC, and the conversion word is automatically placed on the DOUT/RDY line when a conversion is complete. The ADC should be configured for continuous conversion mode.

When DOUT/RDY goes low to indicate the end of a conversion, sufficient SCLK cycles must be applied to the ADC; the data conversion is then placed on the DOUT/RDY line. When the conversion is read, DOUT/RDY returns high until the next conversion is available. In this mode, the data can be read only once. The user must also ensure that the data-word is read before the next conversion is complete. If the user has not read the conversion before the completion of the next conversion, or if insufficient serial clocks are applied to the AD7193 to read the word, the serial output register is reset when the next conversion is complete, and the new conversion is placed in the output serial register.

To exit the continuous read mode, Instruction 01011000 must be written to the communications register while the RDY pin is low. While in the continuous read mode, the ADC monitors activity on the DIN line so that it can receive the instruction to exit the continuous read mode. Additionally, a reset occurs if 40 consecutive 1s are seen on DIN. Therefore, DIN should be held low in continuous read mode until an instruction is to be written to the device.

When several channels are enabled, the ADC continuously steps through the enabled channels and performs one conversion on each channel each time that it is selected. DOUT/RDY pulses low when a conversion is available. When the user applies sufficient SCLK pulses, the data is automatically placed on the DOUT/RDY pin. If the DAT_STA bit in the mode register is set to 1, the contents of the status register are output along with the conversion. The status register indicates the channel to which the conversion corresponds.

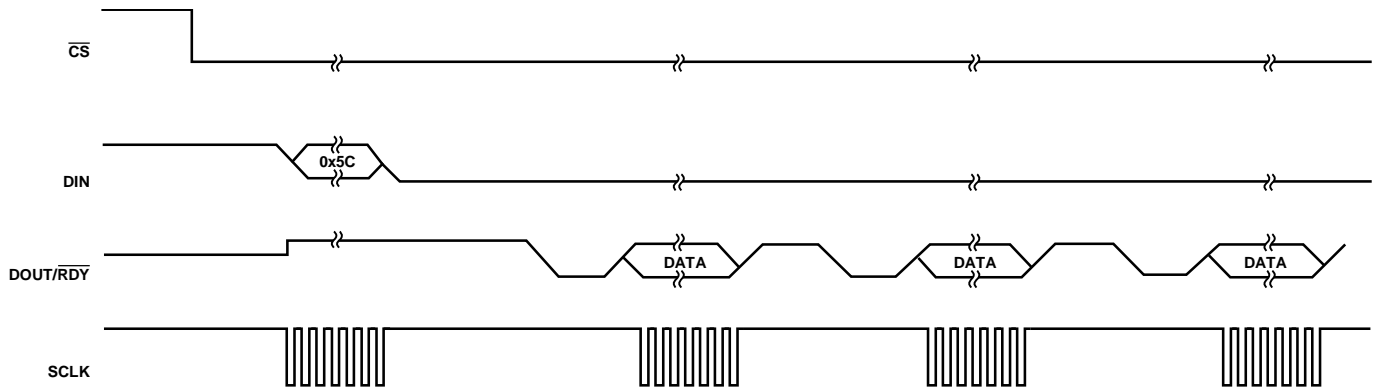

Figure 27. Continuous Read

08367-583

RESET

The circuitry and serial interface of the AD7193 can be reset by writing consecutive 1s to the device; 40 consecutive 1s are required to perform the reset. This resets the logic, the digital filter, and the analog modulator, whereas all on-chip registers are reset to their default values. A reset is automatically performed on power-up. When a reset is initiated, the user must allow a period of 500 μ s before accessing any of the on-chip registers. A reset is useful if the serial interface loses synchronization due to noise on the SCLK line.

SYSTEM SYNCHRONIZATION

The $\overline{\text{SYNC}}$ input allows the user to reset the modulator and the digital filter without affecting any of the setup conditions on the part. This allows the user to start gathering samples of the analog input from a known point in time, that is, the rising edge of $\overline{\text{SYNC}}$. $\overline{\text{SYNC}}$ needs to be taken low for at least four master clock cycles to implement the synchronization function.

If multiple AD7193 devices are operated from a common master clock, they can be synchronized so that their $\overline{\text{data}}$ registers are updated simultaneously. A falling edge on the $\overline{\text{SYNC}}$ pin resets the digital filter and the analog modulator and places the AD7193 into a consistent, known state. While the $\overline{\text{SYNC}}$ pin is low, the AD7193 is maintained in this state. On the $\overline{\text{SYNC}}$ rising edge, the modulator and filter are taken out of this reset state and, on the next clock edge, the part starts to gather input samples again. In a system using multiple AD7193 devices, a common signal to their $\overline{\text{SYNC}}$ pins synchronizes their operation. This is normally done after each AD7193 has performed its own calibration or has calibration coefficients loaded into its calibration registers. The conversions from the AD7193s are then synchronized.

The part is taken out of reset on the master clock falling edge following the $\overline{\text{SYNC}}$ low-to-high transition. Therefore, when multiple devices are being synchronized, the $\overline{\text{SYNC}}$ pin should be taken high on the master clock rising edge to ensure that all devices begin sampling on the master clock falling edge. If the $\overline{\text{SYNC}}$ pin is not taken high in sufficient time, it is possible to have a difference of one master clock cycle between the devices; that is, the instant at which conversions are available differs from part to part by a maximum of one master clock cycle.

The $\overline{\text{SYNC}}$ pin can also be used as a start conversion command. In this mode, the rising edge of $\overline{\text{SYNC}}$ starts conversion, and the falling edge of $\overline{\text{RDY}}$ indicates when the conversion is complete. The settling time of the filter has to be allowed for each data register update. For example, if the ADC is configured to use the sinc⁴ filter, zero latency is disabled, and chop is disabled, the settling time equals $4/f_{\text{ADC}}$, where f_{ADC} is the output data rate when continuously converting on a single channel.

ENABLE PARITY

When the ENPAR bit in the mode register is set to 1, parity is enabled. The contents of the status register must be transmitted along with each 24-bit conversion when the parity function is enabled. To append the contents of the status register to each conversion read, the DAT_STA bit in the mode register should be set to 1. For each conversion read, the parity bit in the status register is programmed so that the overall number of 1s transmitted in the 24-bit data-word is even. Therefore, for example, if the 24-bit conversion contains 11 ones (binary format), the parity bit is set to 1 so that the total number of 1s in the serial transmission is even. If the microprocessor receives an odd number of 1s, it knows that the data received has been corrupted.

The parity function does not ensure that all errors are detected. For example, two bits of corrupt data can result in the microprocessor receiving an even number of 1s. Therefore, an error condition is not detected.

CLOCK

The AD7193 includes an internal 4.92 MHz clock on chip. This internal clock has a tolerance of $\pm 4\%$. Either the internal clock or an external crystal/clock can be used as the clock source to the AD7193. The clock source is selected using the CLK1 and CLK0 bits in the mode register. When an external crystal is used, it must be connected across the MCLK1 and MCLK2 pins.

The crystal manufacturer recommends the load capacitances required for the crystal. The MCLK1 and MCLK2 pins of the AD7193 have a capacitance of 15 pF, typically. If an external clock source is used, the clock source must be connected to the MCLK2 pin, and the MCLK1 pin can remain floating.

The internal clock can also be made available at the MCLK2 pin. This is useful when several ADCs are used in an application and the devices must be synchronized. The internal clock from one device can be used as the clock source for all ADCs in the system. Using a common clock, the devices can be synchronized by applying a common reset to all devices, or the $\overline{\text{SYNC}}$ pin can be pulsed.

BRIDGE POWER-DOWN SWITCH

In bridge applications such as strain gages and load cells, the bridge itself consumes the majority of the current in the system. For example, a 350 Ω load cell requires 15 mA of current when excited with a 5 V supply. To minimize the current consumption of the system, the bridge can be disconnected (when it is not being used) using the bridge power-down switch. Figure 22 shows how the bridge power-down switch is used. The switch can withstand 30 mA of continuous current, and it has an on resistance of 10 Ω maximum.

TEMPERATURE SENSOR

Embedded in the AD7193 is a temperature sensor. This is selected using the TEMP bit in the configuration register. When the TEMP bit is set to 1, the temperature sensor is enabled. When the temperature sensor is selected and bipolar mode is selected, the device should return a code of 0x800000 when the temperature is 0 Kelvin, theoretically. A one-point calibration is needed to obtain the optimum performance from the sensor. Therefore, a conversion at 25°C should be recorded and the sensitivity calculated. The sensitivity is 2815 codes/°C, approximately. The equation for the temperature sensor is

$$\text{Temperature (K)} = (\text{Conversion} - 0x800000)/2815 \text{ K}$$

$$\text{Temperature (°C)} = \text{Temperature (K)} - 273$$

Following the one-point calibration, the internal temperature sensor has an accuracy of $\pm 2^\circ\text{C}$, typically.

LOGIC OUTPUTS

The AD7193 has four general-purpose digital outputs: P0, P1, P2, and P3. These are enabled using the GP32EN and GP10EN bits in the GPOCON register. The pins can be pulled high or low using the P0DAT to P3DAT bits in the GPOCON register; that is, the value at the pin is determined by the setting of the P0DAT to P3DAT bits. The logic levels for these pins are determined by V_{DD} rather than by DV_{DD} . When the GPOCON register is read, Bit P0DAT to Bit P3DAT reflect the actual value at the pins; this is useful for short-circuit detection.

These pins can be used to drive external circuitry, for example, an external multiplexer. If an external multiplexer is used to increase the channel count, the multiplexer logic pins can be controlled via the AD7193 general-purpose output pins. The general-purpose output pins can be used to select the active multiplexer pin. Because the operation of the multiplexer is independent of the AD7193, the AD7193 modulator and filter should be reset using the SYNC pin or by a write to the mode or configuration register each time that the multiplexer channel is changed.

CALIBRATION

The AD7193 provides four calibration modes that can be programmed via the mode bits in the mode register. These modes are internal zero-scale calibration, internal full-scale calibration, system zero-scale calibration, and system full-scale calibration. A calibration can be performed at any time by setting the MD2 to MD0 bits in the mode register appropriately. A calibration should be performed when the gain is changed. After each conversion, the ADC conversion result is scaled using the ADC calibration registers before being written to the data register. The offset calibration coefficient is subtracted from the result prior to multiplication by the full-scale coefficient.

To start a calibration, write the relevant value to the MD2 to MD0 bits. The DOUT/RDY pin and the RDY bit in the status register go high when the calibration initiates. When the calibration is complete, the contents of the corresponding calibration registers are updated, the RDY bit in the status register is reset, the DOUT/RDY pin returns low (if CS is low), and the AD7193 reverts to idle mode.

During an internal zero-scale or full-scale calibration, the respective zero input and full-scale input are automatically connected internally to the ADC input pins. A system calibration, however, expects the system zero-scale and system full-scale voltages to be applied to the ADC pins before initiating the calibration mode. In this way, errors external to the ADC are removed.

From an operational point of view, treat a calibration like another ADC conversion. A zero-scale calibration, if required, must always be performed before a full-scale calibration. Set the system software to monitor the RDY bit in the status register or the DOUT/RDY pin to determine the end of calibration via a polling sequence or an interrupt-driven routine.

With chop disabled, both an internal zero-scale calibration and a system zero-scale calibration require a time equal to the settling time, t_{SETTLE} ($4/f_{ADC}$ for the sinc⁴ filter and $3/f_{ADC}$ for the sinc³ filter).

With chop enabled, an internal zero-scale calibration is not needed because the ADC itself minimizes the offset continuously. However, if an internal zero-scale calibration is performed, the settling time, t_{SETTLE} ($2/f_{ADC}$), is required to perform the calibration. Similarly, a system zero-scale calibration requires a time of t_{SETTLE} to complete.

To perform an internal full-scale calibration, a full-scale input voltage is automatically connected to the selected analog input for this calibration. For a gain of 1, the time required for an internal full-scale calibration is equal to t_{SETTLE} . For higher gains, the internal full-scale calibration requires a time of $2 \times t_{SETTLE}$. A full-scale calibration is recommended each time the gain of a channel is changed to minimize the full-scale error.

A system full-scale calibration requires a time of t_{SETTLE} . With chop disabled, the zero-scale calibration (internal or system zero-scale) should be performed before the system full-scale calibration is initiated.

An internal zero-scale calibration, system zero-scale calibration, and system full-scale calibration can be performed at any output data rate. An internal full-scale calibration can be performed at any output data rate for which the filter word, FS[9:0], is divisible by 16, FS[9:0] being the decimal equivalent of the 10-bit word written to Bit FS9 to Bit FS0 in the mode register. Therefore, internal full-scale calibrations can be performed at output data rates such as 10 Hz or 50 Hz when chop is disabled. Using these lower output data rates, results in better calibration accuracy.

The offset error is, typically, $\pm 150 \mu\text{V}/\text{gain}$. If the gain is changed, it is advisable to perform a calibration. A zero-scale calibration (an internal zero-scale calibration or a system zero-scale calibration) reduces the offset error to the order of the noise.

The gain error of the AD7193 is factory calibrated at a gain of 1 with a 5 V power supply at ambient temperature. Following this calibration, the gain error is, typically, $\pm 0.001\%$ at 5 V. Table 27 shows the typical uncalibrated gain error for the different gain settings.

Table 27. Typical Precalibration Gain Error vs. Gain

| Gain | Precalibration Gain Error (%) |
|------|-------------------------------|
| 8 | -0.11 |
| 16 | -0.20 |
| 32 | -0.23 |
| 64 | -0.29 |
| 128 | -0.39 |

An internal full-scale calibration reduces the gain error to $\pm 0.001\%$, typically, when the gain is equal to 1. For higher gains, the gain error postinternal full-scale calibration is $\pm 0.003\%$, typically, when AV_{DD} is equal to or higher than 4.75 V. When AV_{DD} is less than 4.75 V, the gain error after internal full-scale calibration is $\pm 0.005\%$, typically.

When AV_{DD} is less than 4.75 V, the CLK_DIV bit must be set when performing internal full-scale calibrations. This increases the calibration time by a factor of 2. The accuracy of the internal full-scale calibration is further increased if chop is enabled and a low output data rate is used while performing the calibration.

A system full-scale calibration reduces the gain error to the order of the noise irrespective of the analog power supply voltage.

The AD7193 gives the user access to the on-chip calibration registers, allowing the microprocessor to read the calibration coefficients of the device and also to write its own calibration coefficients from prestored values in the EEPROM. A read of the registers can be performed at any time. However, the ADC must be placed in power-down or idle mode when writing to the registers. The values in the calibration registers are 24 bits wide. The span and offset of the part can also be manipulated using the registers.

DIGITAL FILTER

The AD7193 offers a lot of flexibility in the digital filter. The device has five filter options. The device can be operated with a sinc³ or sinc⁴ filter, chop can be enabled or disabled, and zero latency can be enabled. Finally, an averaging block can be included after the sinc filter, which gives a fast settling mode. The option selected affects the output data rate, settling time, and 50 Hz/60 Hz rejection. The following sections describe each filter type, indicating the available output data rates for each filter option. The filter response, along with the settling time and 50 Hz/60 Hz rejection, is also discussed.

SINC⁴ FILTER (CHOP DISABLED)

When the AD7193 is powered up, the sinc⁴ filter is selected by default and chop is disabled. This filter gives excellent noise performance over the complete range of output data rates. It also gives the best 50 Hz/60 Hz rejection, but it has a long settling time.

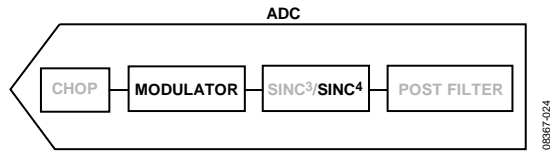

Figure 28. Sinc⁴ Filter (Chop Disabled)

Sinc⁴ Output Data Rate/Settling Time

The output data rate (the rate at which conversions are available on a single channel when the ADC is continuously converting) is equal to

$$f_{ADC} = f_{CLK} / (1024 \times FS[9:0])$$

where:

f_{ADC} is the output data rate.

f_{CLK} is the master clock (4.92 MHz nominal).

$FS[9:0]$ is the decimal equivalent of Bit FS9 to Bit FS0 in the mode register.

The output data rate can be programmed from 4.7 Hz to 4800 Hz; that is, $FS[9:0]$ can have a value from 1 to 1023.

The settling time for the sinc⁴ filter is equal to

$$t_{SETTLE} = 4 / f_{ADC}$$

When a channel change occurs, the modulator and filter are reset. The settling time is allowed to generate the first conversion after the channel change. Subsequent conversions on this channel occur at $1/f_{ADC}$.

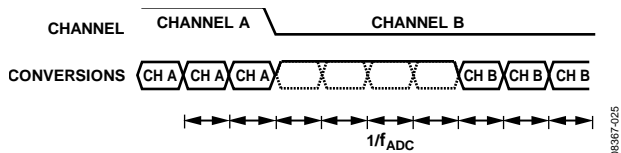

Figure 29. Sinc⁴ Channel Change

When conversions are performed on a single channel and a step change occurs, the ADC does not detect the change in analog input. Therefore, it continues to output conversions at the programmed output data rate. However, it is at least four conversions later before the output data accurately reflect the analog input. If the step change occurs while the ADC is processing a conversion, then the ADC takes five conversions after the step change to generate a fully settled result.

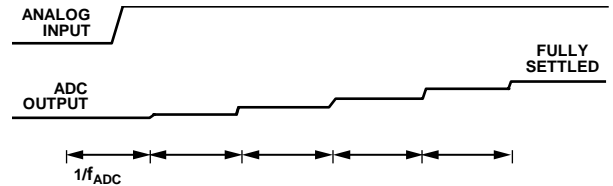

Figure 30. Asynchronous Step Change in Analog Input

The 3 dB frequency for the sinc⁴ filter is equal to

$$f_{3dB} = 0.23 \times f_{ADC}$$

Table 28 gives some examples of the relationship between the values in Bits $FS[9:0]$ and the corresponding output data rate and settling time.

Table 28. Examples of Output Data Rates and the Corresponding Settling Time

| FS[9:0] | Output Data Rate (Hz) | Settling Time (ms) |
|---------|-----------------------|--------------------|
| 480 | 10 | 400 |
| 96 | 50 | 80 |
| 80 | 60 | 66.6 |

Sinc⁴ Zero Latency

Zero latency is enabled by setting the single bit (Bit 11) in the mode register to 1. With zero latency, the complete settling time is allowed for each conversion. Therefore, the conversion time when converting on a single channel or when converting on several channels is constant. The user does not need to consider the effects of channel changes on the output data rate. When the channel sequencer is enabled, the AD7193 automatically operates in zero latency mode.

The output data rate equals

$$f_{ADC} = 1 / t_{SETTLE} = f_{CLK} / (4 \times 1024 \times FS[9:0])$$

where:

f_{ADC} is the output data rate.

f_{CLK} is the master clock (4.92 MHz nominal).

$FS[9:0]$ is the decimal equivalent of Bit FS9 to Bit FS0 in the mode register.

When the analog input is constant or a channel change occurs, valid conversions are available at a constant output data rate. When conversions are being performed on a single channel and a step change occurs on the analog input, the ADC continues to output fully settled conversions if the step change is synchronized with the conversion process. If the step change is asynchronous, one conversion is output from the ADC, which is not completely settled (see Figure 31).

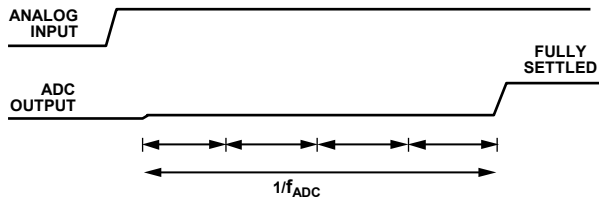

Figure 31. Sinc⁴ Zero Latency Operation

Table 29 shows examples of output data rate and the corresponding FS values.

Table 29. Examples of Output Data Rates and the Corresponding Settling Time (Zero Latency)

| FS[9:0] | Output Data Rate (Hz) | Settling Time (ms) |
|---------|-----------------------|--------------------|
| 480 | 2.5 | 400 |
| 96 | 12.5 | 80 |
| 80 | 15 | 66.6 |

Sinc⁴ 50 Hz/60 Hz Rejection

Figure 32 shows the frequency response of the sinc⁴ filter when FS[9:0] is set to 96 and the master clock is 4.92 MHz. With zero latency disabled, the output data rate is equal to 50 Hz. With zero latency enabled, the output data rate is 12.5 Hz. The sinc⁴ filter provides 50 Hz (±1 Hz) rejection in excess of 120 dB minimum, assuming a stable master clock.

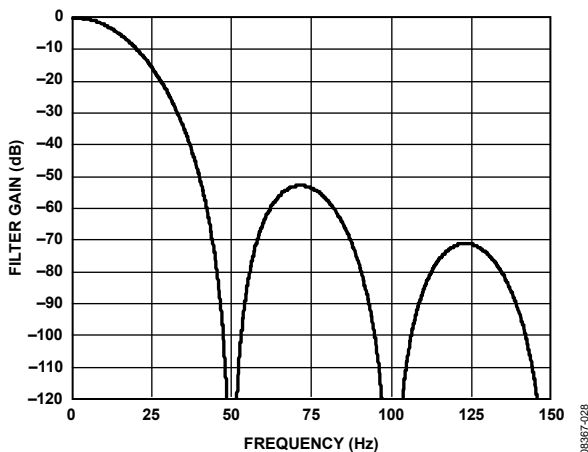

Figure 32. Sinc⁴ Filter Response (FS[9:0] = 96)

Figure 33 shows the frequency response when FS[9:0] is programmed to 80 and the master clock is equal to 4.92 MHz. The output data rate is 60 Hz when zero latency is disabled and 15 Hz when zero latency is enabled. The sinc⁴ filter provides 60 Hz (±1 Hz) rejection of 120 dB minimum, assuming a stable master clock.

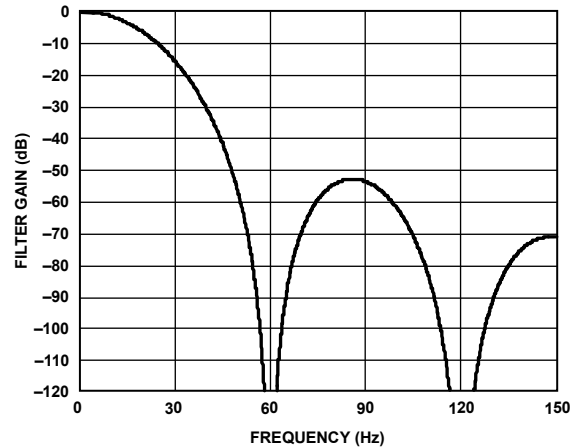

Figure 33. Sinc⁴ Filter Response (FS[9:0] = 80)

Simultaneous 50 Hz and 60 Hz rejection is obtained when FS[9:0] is programmed to 480 and the master clock equals 4.92 MHz. The output data rate is 10 Hz when zero latency is disabled and 2.5 Hz when zero latency is enabled. The sinc⁴ filter provides 50 Hz (±1 Hz) and 60 Hz (±1 Hz) rejection of 120 dB minimum, assuming a stable master clock.

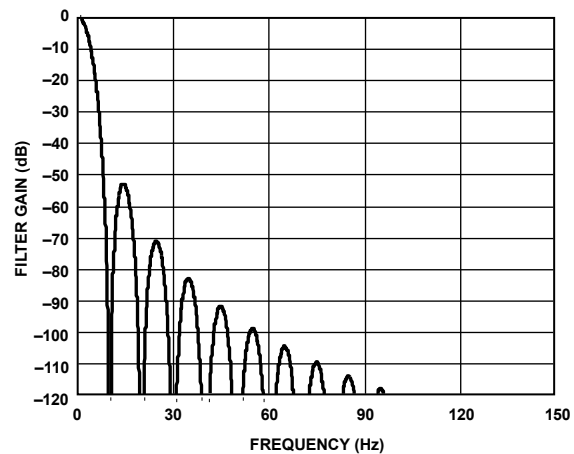

Figure 34. Sinc⁴ Filter Response (FS[9:0] = 480)

Simultaneous 50 Hz/60 Hz rejection can also be achieved using the REJ60 bit in the mode register. When FS[9:0] is set to 96 and REJ60 is set to 1, notches are placed at 50 Hz and 60 Hz.

The output data rate is 50 Hz when zero latency is disabled and 12.5 Hz when zero latency is enabled. Figure 35 shows the frequency response of the sinc⁴ filter. The filter provides 50 Hz ± 1 Hz and 60 Hz ± 1 Hz rejection of 82 dB minimum, assuming a stable 4.92 MHz master clock.

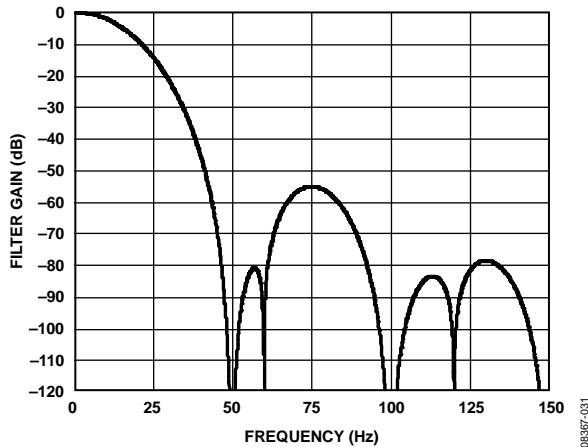

Figure 35. Sinc⁴ Filter Response (FS[9:0] = 96, REJ60 = 1)

SINC³ FILTER (CHOP DISABLED)

A sinc³ filter can be used instead of the sinc⁴ filter. The filter is selected using the SINC3 bit in the mode register. The sinc³ filter is selected when the SINC3 bit is set to 1.

This filter has good noise performance when operating with output data rates up to 1 kHz. It has moderate settling time and moderate 50 Hz/60 Hz (±1 Hz) rejection.

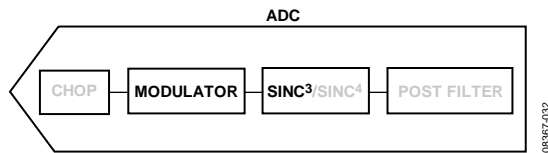

Figure 36. Sinc³ Filter (Chop Disabled)

Sinc³ Output Data Rate and Settling Time

The output data rate (the rate at which conversions are available on a single channel when the ADC is continuously converting) is equal to

$$f_{ADC} = f_{CLK} / (1024 \times FS[9:0])$$

where:

f_{ADC} is the output data rate.

f_{CLK} is the master clock (4.92 MHz nominal).

FS[9:0] is the decimal equivalent of Bit FS9 to Bit FS0 in the mode register.

The output data rate can be programmed from 4.7 Hz to 4800 Hz; that is, FS[9:0] can have a value from 1 to 1023.

The settling time is equal to

$$t_{SETTLE} = 3 / f_{ADC}$$

The 3 dB frequency is equal to

$$f_{3dB} = 0.272 \times f_{ADC}$$

Table 30 gives some examples of FS settings and the corresponding output data rates and settling times.

Table 30. Examples of Output Data Rates and the Corresponding Settling Time

| FS[9:0] | Output Data Rate (Hz) | Settling Time (ms) |
|---------|-----------------------|--------------------|
| 480 | 10 | 300 |
| 96 | 50 | 60 |
| 80 | 60 | 50 |

When a channel change occurs, the modulator and filter reset. The complete settling time is allowed to generate the first conversion after the channel change (see Figure 37). Subsequent conversions on this channel are available at 1/f_{ADC}.

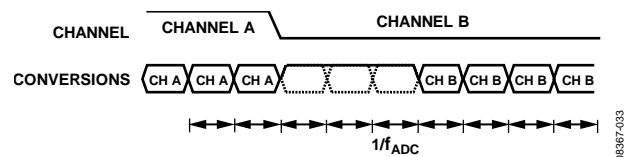

Figure 37. Sinc³ Channel Change

When conversions are performed on a single channel and a step change occurs, the ADC does not detect the change in analog input. Therefore, it continues to output conversions at the programmed output data rate. However, it is at least three conversions later before the output data accurately reflects the analog input. If the step change occurs while the ADC is processing a conversion, the ADC takes four conversions after the step change to generate a fully settled result.

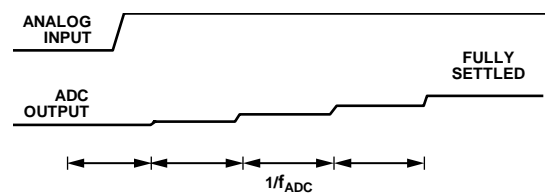

Figure 38. Asynchronous Step Change in Analog Input

Sinc³ Zero Latency

Zero latency is enabled by setting the single bit (Bit 11) in the mode register to 1. With zero latency, the complete settling time is allowed for each conversion. Therefore, the conversion time when converting on a single channel or when converting on several channels is constant. The user does not need to consider the effects of channel changes on the output data rate. When the channel sequencer is enabled, the AD7193 automatically operates in zero latency mode.

The output data rate equals

$$f_{ADC} = 1 / t_{SETTLE} = f_{CLK} / (3 \times 1024 \times FS[9:0])$$

where:

f_{ADC} is the output data rate.

f_{CLK} is the master clock (4.92 MHz nominal).

$FS[9:0]$ is the decimal equivalent of Bit FS9 to Bit FS0 in the mode register.

When the analog input is constant or a channel change occurs, valid conversions are available at a constant output data rate. When conversions are being performed on a single channel and a step change occurs on the analog input, the ADC continues to output fully settled conversions if the step change is synchronized with the conversion process. If the step change is asynchronous, one conversion is output from the ADC that is not completely settled (see Figure 39).

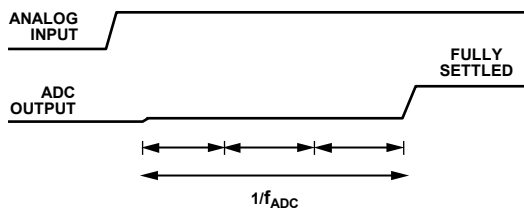

Figure 39. Sinc³ Zero Latency Operation

Table 31 provides examples of output data rates and the corresponding FS values.

Table 31. Examples of Output Data Rates and the Corresponding Settling Time (Zero Latency)

| FS[9:0] | Output Data Rate (Hz) | Settling Time (ms) |
|---------|-----------------------|--------------------|
| 480 | 3.3 | 300 |
| 96 | 16.7 | 60 |
| 80 | 20 | 50 |

Sinc³ 50 Hz/60 Hz Rejection

Figure 40 show the frequency response of the sinc³ filter when FS[9:0] is set to 96 and the master clock equals 4.92 MHz. The output data rate is equal to 50 Hz when zero latency is disabled and 16.7 Hz when zero latency is enabled. The sinc³ filter gives 50 Hz ± 1 Hz rejection of 95 dB minimum for a stable master clock.

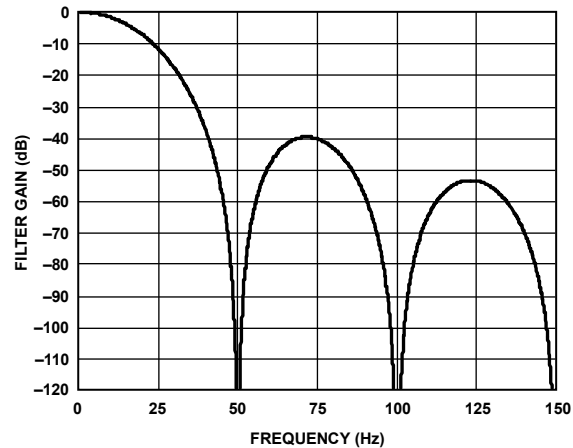

Figure 40. Sinc³ Filter Response (FS[9:0] = 96)

When FS[9:0] is set to 80 and the master clock equals 4.92 MHz, 60 Hz rejection is achieved (see Figure 41). The output data rate is equal to 60 Hz when zero latency is disabled and 20 Hz when zero latency is enabled. The sinc³ filter has rejection of 95 dB minimum at 60 Hz ± 1 Hz, assuming a stable master clock.

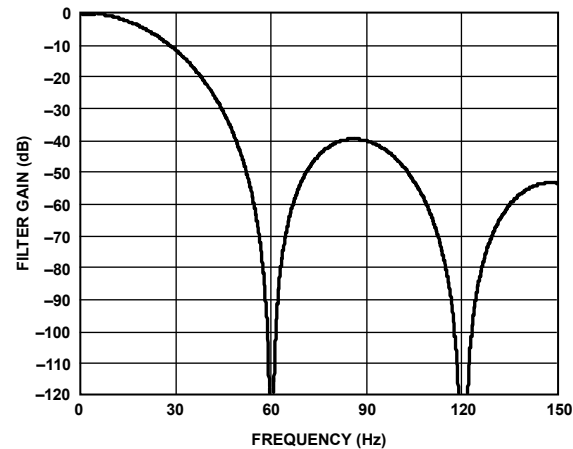

Figure 41. Sinc³ Filter Response (FS[9:0] = 80)

Simultaneous 50 Hz and 60 Hz rejection is obtained when FS[9:0] is set to 480 (master clock = 4.92 MHz), as shown in Figure 42. The output data rate is 10 Hz when zero latency is disabled and 3.3 Hz when zero latency is enabled. The sinc³ filter has rejection of 100 dB minimum at 50 Hz ± 1 Hz and 60 Hz ± 1 Hz.

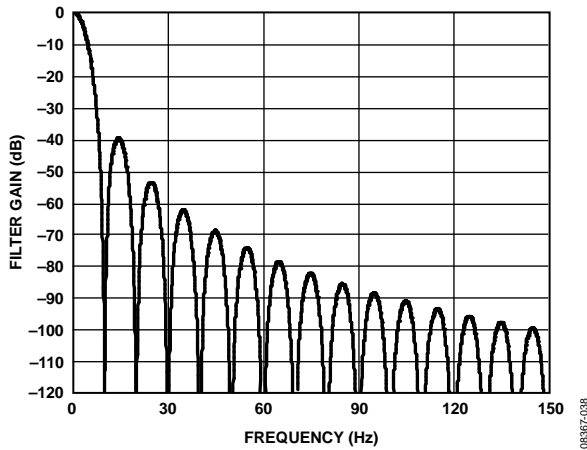

Figure 42. Sinc³ Filter Response (FS[9:0] = 480)

Simultaneous 50 Hz/60 Hz rejection is also achieved using the REJ60 bit in the mode register. When FS[9:0] is programmed to 96 and the REJ60 bit is set to 1, notches are placed at both 50 Hz and 60 Hz for a stable 4.92 MHz master clock. Figure 43 shows the frequency response of the sinc³ filter with this configuration. Assuming a stable clock, the rejection at 50 Hz/60 Hz (±1 Hz) is in excess of 67 dB minimum.

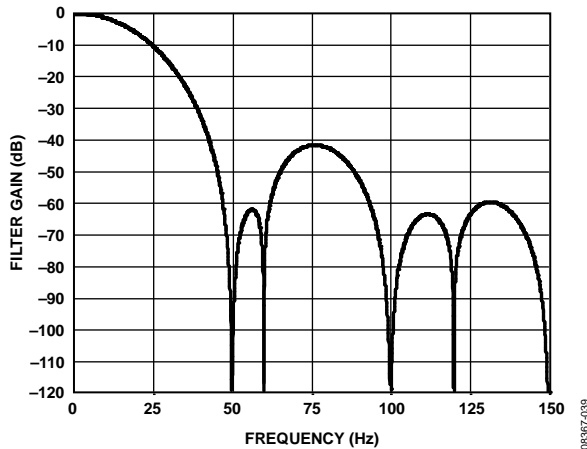

Figure 43. Sinc³ Filter Response (FS[9:0] = 96, REJ60 = 1)

CHOP ENABLED (SINC⁴ FILTER)

With chop enabled, the ADC offset and offset drift are minimized. The analog input pins are continuously swapped. With the analog input pins connected in one direction, the settling time of the sinc filter is allowed and a conversion is recorded. The analog input pins are then inverted, and another settled conversion is obtained. Subsequent conversions are averaged to minimize the offset. This continuous swapping of the analog input pins and the averaging of subsequent conversions means that the offset drift is also minimized. With chop enabled, the resolution increases by 0.5 bits.

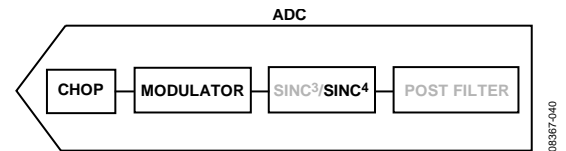

Figure 44. Chop Enabled

Output Data Rate and Settling Time (Sinc⁴ Chop Enabled)

For the sinc⁴ filter, the output data rate is equal to

$$f_{ADC} = f_{CLK} / (4 \times 1024 \times FS[9:0])$$

where:

f_{ADC} is the output data rate.

f_{CLK} is the master clock (4.92 MHz nominal).

FS[9:0] is the decimal equivalent of Bit FS9 to Bit FS0 in the mode register.

The value of FS[9:0] can be varied from 1 to 1023. This results in an output data rate of 1.17 Hz to 1200 Hz. The settling time is equal to

$$t_{SETTLE} = 2 / f_{ADC}$$

Table 32 gives some examples of FS[9:0] values and the corresponding output data rates and settling times.

Table 32. Examples of Output Data Rates and the Corresponding Settling Time

| FS[9:0] | Output Data Rate (Hz) | Settling Time (ms) |
|---------|-----------------------|--------------------|
| 96 | 12.5 | 160 |
| 80 | 15 | 133 |

When a channel change occurs, the modulator and filter reset. The complete settling time is required to generate the first conversion after the channel change. Subsequent conversions on this channel occur at $1/f_{ADC}$.

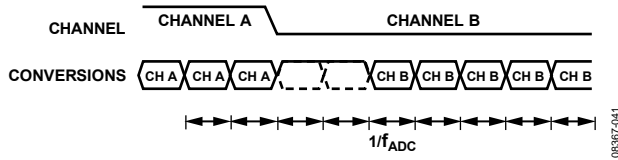

Figure 45. Channel Change (*Sinc⁴ Chop Enabled*)

When conversions are performed on a single channel and a step change occurs, the ADC does not detect the change in analog input; therefore, it continues to output conversions at the programmed output data rate. However, it is at least two conversions later before the output data accurately reflects the analog input. If the step change occurs while the ADC is processing a conversion, the ADC takes three conversions after the step change to generate a fully settled result.

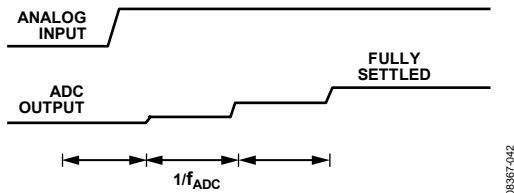

Figure 46. Asynchronous Step Change in Analog Input (*Sinc⁴ Chop Enabled*)

The cutoff frequency f_{3dB} is equal to

$$f_{3dB} = 0.24 \times f_{ADC}$$

50 Hz/60 Hz Rejection (*Sinc⁴ Chop Enabled*)

When FS[9:0] is set to 96 and chopping is enabled, the output data rate is equal to 12.5 Hz for a 4.92 MHz master clock. The filter response shown in Figure 47 is obtained. The chopping introduces notches at odd integer multiples of $f_{ADC}/2$. The notches due to the sinc filter in addition to the notches introduced by the chopping mean that simultaneous 50 Hz and 60 Hz rejection is achieved for an output data rate of 12.5 Hz. The rejection at 50 Hz/60 Hz ± 1 Hz is typically 63 dB, assuming a stable master clock.

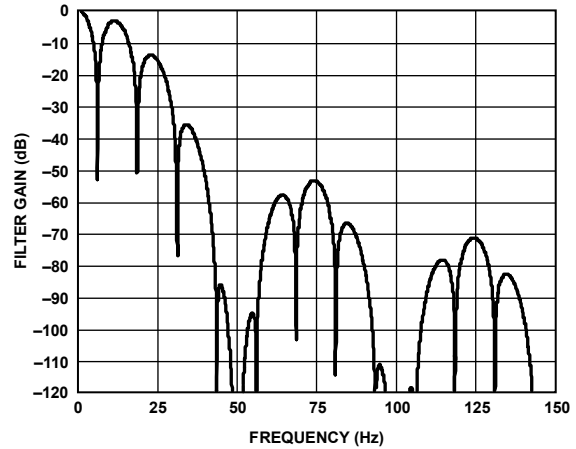

Figure 47. *Sinc⁴ Filter Response (FS[9:0] = 96, Chop Enabled)*

The 50 Hz/60 Hz rejection can be improved by setting the REJ60 bit in the mode register to 1. With FS[9:0] set to 96 and REJ60 set to 1, the filter response shown in Figure 48 is achieved. The output data rate is unchanged but the 50 Hz/60 Hz (± 1 Hz) rejection is increased to 83 dB typically.

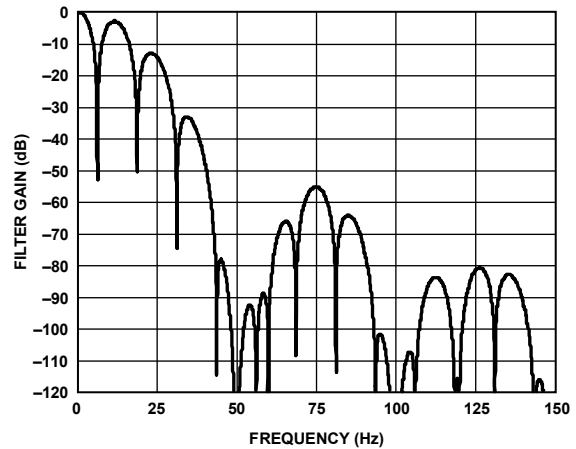

Figure 48. *Sinc⁴ Filter Response (FS[9:0] = 96, Chop Enabled, REJ60 = 1)*

CHOP ENABLED (SINC³ FILTER)

With chop enabled, the ADC offset and offset drift are minimized. The analog input pins are continuously swapped. With the analog input pins connected in one direction, the settling time of the sinc filter is allowed and a conversion is recorded. The analog input pins invert and another settled conversion is obtained. Subsequent conversions are averaged to minimize the offset. This continuous swapping of the analog input pins and the averaging of subsequent conversions means that the offset drift is also minimized. With chop enabled, the resolution increases by 0.5 bits. Using the sinc³ filter with chop enabled is suitable for output data rates up to 320 Hz.

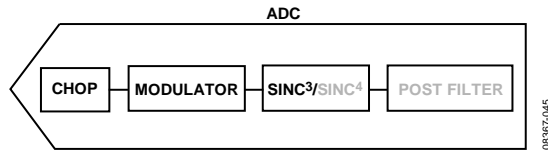

Figure 49. Chop Enabled (Sinc³ Chop Enabled)

Output Data Rate and Settling Time (Sinc³ Chop Enabled)

For the sinc³ filter, the output data rate is equal to

$$f_{ADC} = f_{CLK} / (3 \times 1024 \times FS[9:0])$$

where:

f_{ADC} is the output data rate.

f_{CLK} is the master clock (4.92 MHz nominal).

$FS[9:0]$ is the decimal equivalent of Bit FS9 to Bit FS0 in the mode register.

The value of $FS[9:0]$ can be varied from 1 to 1023. This results in an output data rate of 1.56 Hz to 1600 Hz. The settling time is equal to

$$t_{SETTLE} = 2 / f_{ADC}$$

Table 33. Examples of Output Data Rates and the Corresponding Settling Time (Chop Enabled, Sinc³ Filter)

| FS[9:0] | Output Data Rate (Hz) | Settling Time (ms) |
|---------|-----------------------|--------------------|
| 96 | 16.7 | 120 |
| 80 | 20 | 100 |

When a channel change occurs, the modulator and filter are reset. The complete settling time is required to generate the first conversion after the channel change. Subsequent conversions on this channel occur at $1/f_{ADC}$.

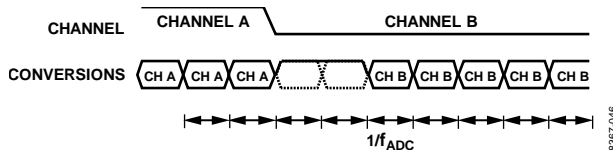

Figure 50. Channel Change (Sinc³ Chop Enable)

If conversions are performed on a single channel and a step change occurs, the ADC does not detect the change in analog input; therefore, it continues to output conversions at the programmed output data rate. However, it is at least two conversions later before the output data accurately reflects the analog input. If the step change occurs while the ADC is processing a conversion, then the ADC takes three conversions after the step change to generate a fully settled result.

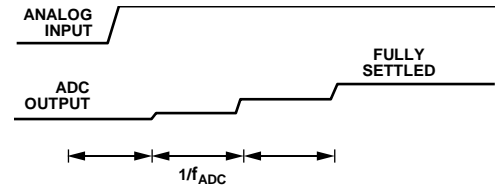

Figure 51. Asynchronous Step Change in Analog Input (Sinc³ Chop Enabled)

The cutoff frequency f_{3dB} is equal to

$$f_{3dB} = 0.24 \times f_{ADC}$$

50 Hz/60 Hz Rejection (Sinc³ Chop Enabled)

When $FS[9:0]$ is set to 96 and chopping is enabled, the filter response shown in Figure 52 is obtained. The output data rate is equal to 16.7 Hz for a 4.92 MHz master clock. The chopping introduces notches at odd integer multiples of $f_{ADC}/2$. The notches due to the sinc filter in addition to the notches introduced by the chopping means that simultaneous 50 Hz and 60 Hz rejection is achieved for an output data rate of 16.7 Hz. The rejection at 50 Hz/60 Hz ± 1 Hz is typically 53 dB, assuming a stable master clock.

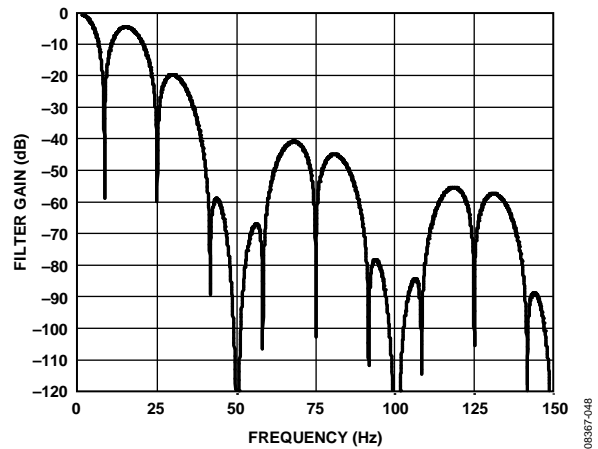

Figure 52. Sinc³ Filter Response ($FS[9:0] = 96$, Chop Enabled)

The 50 Hz/60 Hz rejection can be improved by setting the REJ60 bit in the mode register to 1. With FS[9:0] set to 96 and REJ60 set to 1, the filter response shown in Figure 53 is achieved. The output data rate is unchanged but the 50 Hz/60 Hz ± 1 Hz rejection improves to 73 dB typically.

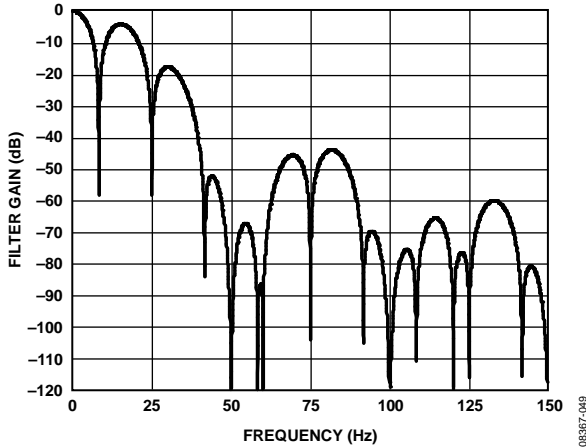

Figure 53. Sinc³ Filter Response (FS[9:0] = 96, Chop Enabled, REJ60 = 1)

FAST SETTLING MODE (SINC⁴ FILTER)

In fast settling mode, the settling time is close to the inverse of the first filter notch; therefore, the user can achieve 50 Hz and/or 60 Hz rejection at an output data rate close to 1/50 Hz or 1/60 Hz. The settling time is equal to 1/output data rate. Therefore, the conversion time is constant when converting on a single channel or when converting on several channels. There is no added latency when switching channels.

Enable the fast settling mode using Bit AVG1 and Bit AVG0 in the mode register. In fast settling mode, a postfilter is included after the sinc⁴ filter. The postfilter averages by 2, 8, or 16, depending on the settings of the AVG1 and AVG0 bits.

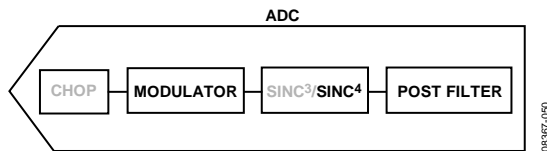

Figure 54. Fast Settling Mode, Sinc⁴ Filter

Output Data Rate and Settling Time, Sinc⁴ Filter

With chop disabled, the output data rate is

$$f_{ADC} = f_{CLK} / ((4 + Avg - 1) \times 1024 \times FS[9:0]) \tag{1}$$

f_{ADC} is the output data rate.

f_{CLK} is the master clock (4.92 MHz nominal).

Avg is the average.

FS[9:0] is the decimal equivalent of Bit FS9 to Bit FS0 in the mode register.

If AVG1 = AVG0 = 0, the fast settling mode is not enabled.

In this case, Equation 1 is not relevant.

The settling time is equal to

$$t_{SETTLE} = 1/f_{ADC}$$

Table 34 lists sample FS words and the corresponding output data rates and settling times.

Table 34. Examples of Output Data Rates and the Corresponding Settling Time (Fast Settling Mode, Sinc⁴)

| FS[9:0] | Average | Output Data Rate (Hz) | Settling Time (ms) |
|---------|---------|-----------------------|--------------------|
| 96 | 16 | 2.63 | 380 |
| 30 | 16 | 8.4 | 118.75 |
| 6 | 16 | 42.1 | 23.75 |
| 5 | 16 | 50.53 | 19.79 |

When the analog input channel is changed, there is no additional delay in generating valid conversions—the device functions as a zero latency ADC.

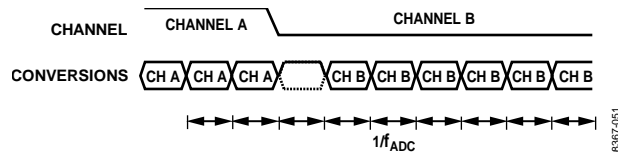

Figure 55. Fast Settling, Sinc⁴ Filter

When the device is converting on a single channel and a step change occurs on the analog input, the ADC does not detect the change and continues to output conversions. If the step change is synchronized with the conversion, only fully settled results are output from the ADC. However, if the step change is asynchronous to the conversion process, there is one intermediate result, which is not completely settled (see Figure 56).

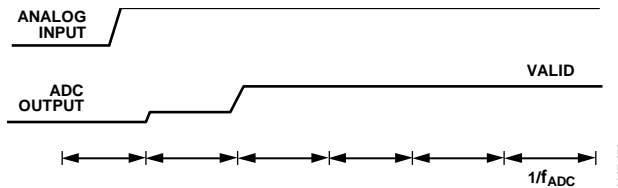

Figure 56. Step Change on Analog Input, Sinc⁴ Filter

The output data rate is the same for chop enabled and chop disabled in fast settling mode. However, when chop is enabled, the settling time equals

$$t_{SETTLE} = 2/f_{ADC}$$

Therefore, if chop is enabled, the sinc⁴ filter is selected, FS[9:0] is set to 6, and averaging by 16 is enabled. The output data rate is equal to 42.1 Hz when the master clock equals 4.92 MHz. Therefore, the conversion time equals 1/42.10 Hz or 23.75 ms and the settling time is equal to 47.5 ms.

50 Hz/60 Hz Rejection, Sinc⁴ Filter

Figure 57 shows the frequency response when FS[9:0] is set to 6 and the postfilter averages by 16. This gives an output data rate of 42.10 Hz when the master clock equals 4.92 MHz. The sinc filter places the first notch at

$$f_{NOTCH} = f_{CLK} / (1024 \times FS[9:0])$$

The postfiltering places notches at f_{NOTCH}/Avg (Avg is the amount of averaging) and multiples of this frequency; therefore, when FS[9:0] is set to 6 and the postfilter averaging is 16, a notch is placed at 800 Hz due to the sinc filter and notches are placed at 50 Hz and multiples of 50 Hz due to the postfilter. The notch at 50 Hz is a first-order notch; therefore, the notch is not wide. This means that the rejection at 50 Hz exactly is good, assuming a stable 4.92 MHz master clock. However, in a band of 50 Hz ± 1 Hz, the rejection degrades significantly. The rejection at 50 Hz ± 0.5 Hz is 40 dB minimum, assuming a stable clock; therefore, a good master clock source is recommended when using fast settling mode.

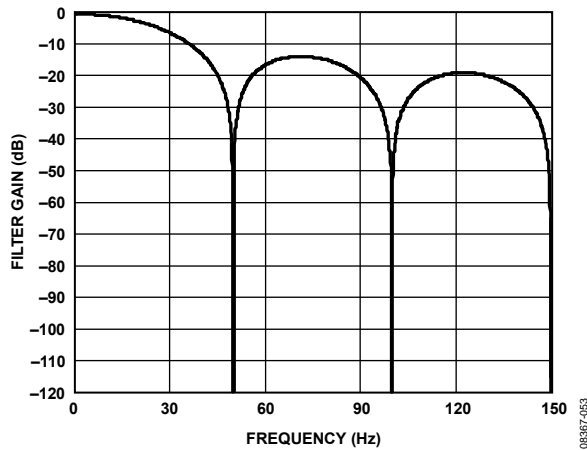

Figure 57. Filter Response for Average + Decimate Filter (Sinc⁴ Filter, FS[9:0] = 6, Average by 16)

Figure 58 shows the filter response when FS[9:0] is set to 5 and the postfilter averages by 16. In this case, the output data rate is equal to 50.53 Hz (4.92 MHz master clock) while the first filter notch is placed at 60 Hz. The rejection at 60 Hz ± 0.5 Hz is equal to 40 dB minimum.

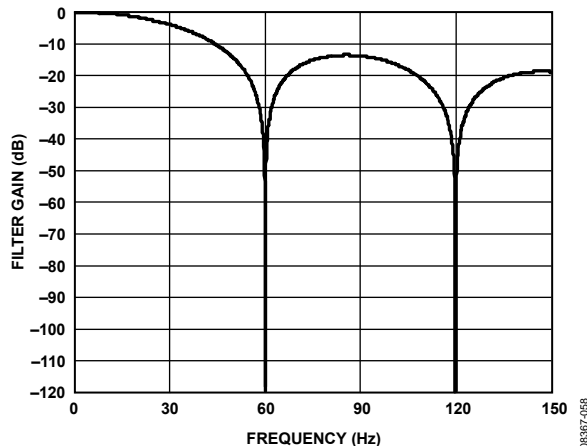

Figure 58. Filter Response for Average + Decimate Filter (Sinc⁴ Filter, FS[9:0] = 5, Average by 16)

Simultaneous 50 Hz/60 Hz rejection is achieved when FS[9:0] is set to 30 and the postfilter averages by 16. The output data rate is equal to 8.4 Hz, whereas the rejection at 50 Hz ± 0.5 Hz and 60 Hz ± 0.5 Hz is typically 44 dB.

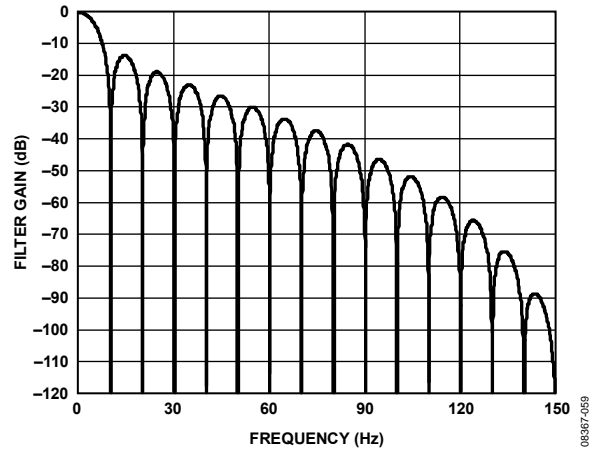

Figure 59. Filter Response for Average + Decimate Filter (Sinc⁴ Filter, FS[9:0] = 30, Average by 16)

Simultaneous 50 Hz and 60 Hz rejection is also achieved by using an FS word of 96 and averaging by 16; this places a notch at 50 Hz. Setting the REJ60 bit to 1 places a notch at 60 Hz (see Figure 60). The output data rate is reduced to 2.63 Hz with this configuration but the rejection is improved to typically 100 dB at 50 Hz ± 1 Hz and 60 Hz ± 1 Hz.

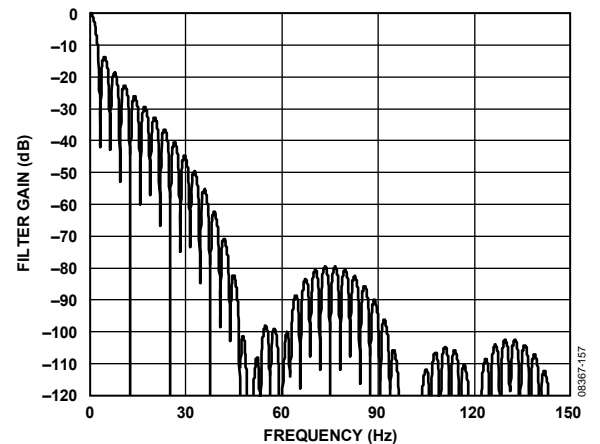

Figure 60. Filter Response for Average + Decimate Filter (Sinc⁴ Filter, FS[9:0] = 96, Average by 16)

FAST SETTling MODE (SINC³ FILTER)

In fast settling mode, the settling time is close to the inverse of the first filter notch. Therefore, the user can achieve 50 Hz and/or 60 Hz rejection at an output data rate close to 1/50 Hz or 1/60 Hz. The settling time is equal to 1/output data rate. Therefore, the conversion time is constant when converting on a single channel or when converting on several channels. There is no added latency when switching channels.

The fast settling mode is enabled using Bit AVG1 and Bit AVG0 in the mode register. A postfilter is included after the sinc⁴ filter. The postfilter averages by 2, 8, or 16, depending on the settings of the AVG1 and AVG0 bits.

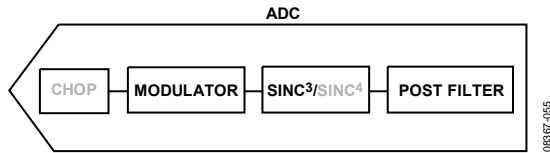

Figure 61. Fast Settling Mode, Sinc³ Filter

Output Data Rate and Settling Time, Sinc³ Filter

With chop disabled, the output data rate is

$$f_{ADC} = f_{CLK} / ((3 + Avg - 1) \times 1024 \times FS[9:0])$$

f_{ADC} is the output data rate.

f_{CLK} is master clock (4.92 MHz nominal).

Avg is the average.

FS[9:0] is the decimal equivalent of Bit FS9 to Bit FS0 in the mode register.

If AVG1 = AVG0 = 0, the fast settling mode is not enabled. In this case, the preceding equation is not relevant.

The settling time is equal to

$$t_{SETTLE} = 1/f_{ADC}$$

Table 35 lists some sample FS words and the corresponding output data rates and settling times.

Table 35. Examples of Output Data Rates and the Corresponding Settling Time (Fast Settling Mode, Sinc³)

| FS[9:0] | Average | Output Data Rate (Hz) | Settling Time (ms) |
|---------|---------|-----------------------|--------------------|
| 96 | 16 | 2.78 | 360 |
| 30 | 16 | 8.9 | 112.5 |
| 6 | 16 | 44.44 | 22.5 |
| 5 | 16 | 53.3 | 18.75 |

If the analog input channel is changed, there is no additional delay in generating valid conversions and the device functions as a zero latency ADC.

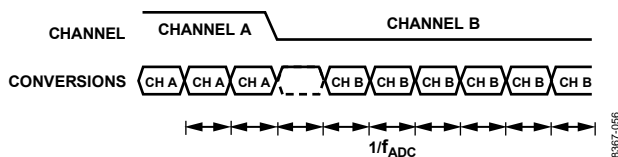

Figure 62. Fast Settling, Sinc³ Filter

When the device is converting on a single channel and a step change occurs on the analog input, the ADC does not detect the change and continues to output conversions. When the step change is synchronized with the conversion, only fully settled results are output from the ADC. However, if the step change is asynchronous to the conversion process, one intermediate result is not completely settled (see Figure 63).

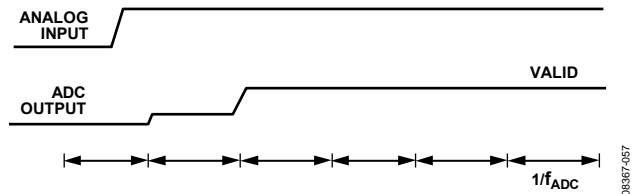

Figure 63. Step Change on Analog Input, Sinc³ Filter

50 Hz/60 Hz Rejection, Sinc³ Filter

Figure 64 shows the frequency response when FS[9:0] is set to 6 and the postfilter averages by 16. This gives an output data rate of 44.44 Hz when the master clock is 4.92 MHz. The sinc filter places the first notch at

$$f_{NOTCH} = f_{CLK} / (1024 \times FS[9:0])$$

The postfiltering places notches at f_{NOTCH}/Avg (Avg is the amount of averaging) and multiples of this frequency. Therefore, when FS[9:0] is set to 6 and the postfilter averaging is 16, a notch is placed at 800 Hz due to the sinc filter and notches are placed at 50 Hz and multiples of 50 Hz due to the postfilter.

The notch at 50 Hz is a first-order notch. Therefore, the notch is not wide. This means that the rejection at 50 Hz exactly is good, assuming a stable 4.92 MHz master clock. However, in a band of 50 Hz ± 1 Hz, the rejection degrades significantly. The rejection at 50 Hz ± 0.5 Hz is 40 dB minimum, assuming a stable clock; therefore, a good master clock source is recommended when using fast settling mode.

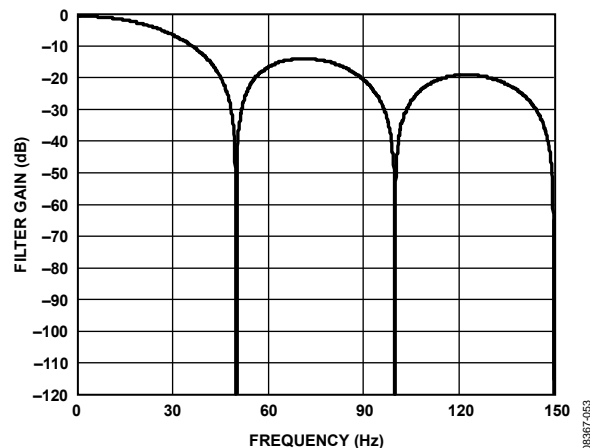

Figure 64. Filter Response for Average + Decimate Filter (Sinc³ Filter, FS[9:0] = 6, Average by 16)

Figure 65 shows the filter response when FS[9:0] is set to 5 and the post filter averages by 16. In this case, the output data rate is equal to 53.33 Hz when the first filter notch is placed at 60 Hz. The rejection at 60 Hz ± 0.5 Hz is equal to 40 dB minimum.

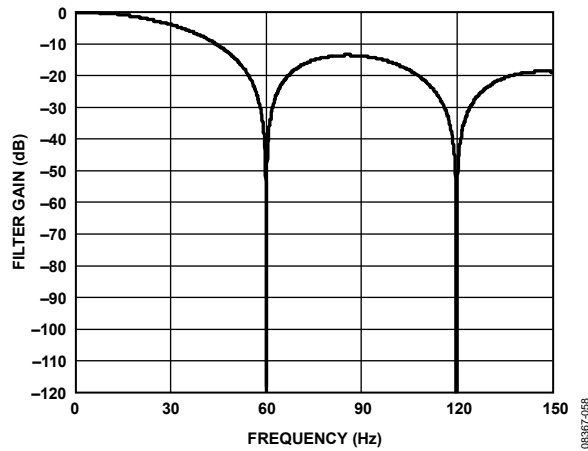

Figure 65. Filter Response for Average + Decimate Filter (Sinc³ Filter, FS[9:0] = 5, Average by 16)

Simultaneous 50 Hz/60 Hz rejection is achieved when FS[9:0] is set to 30 and the postfilter averages by 16. The output data rate is equal to 8.9 Hz whereas the rejection at 50 Hz ± 0.5 Hz and 60 Hz ± 0.5 Hz is typically 42 dB.

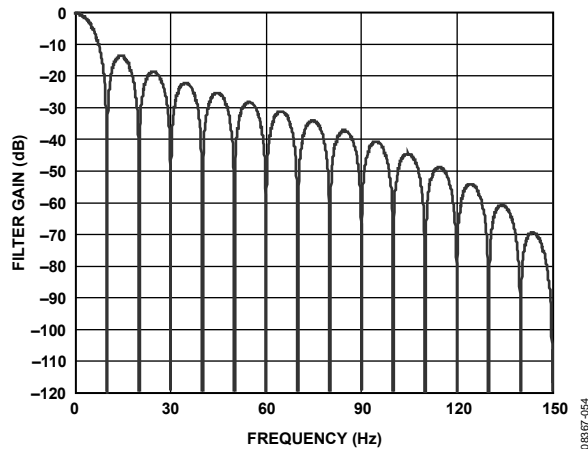

Figure 66. Filter Response for Average + Decimate Filter (Sinc³ Filter, FS[9:0] = 30, Average by 16)

Simultaneous 50 Hz and 60 Hz rejection is also achieved by using an FS word of 96 and averaging by 16, which places a notch at 50 Hz. Setting the REJ60 bit to 1 places a notch at 60 Hz (see Figure 67). The output data rate is reduced to 2.78 Hz with this configuration, but the rejection is improved to 94 dB typically at 50 Hz ± 1 Hz and 60 Hz ± 1 Hz.

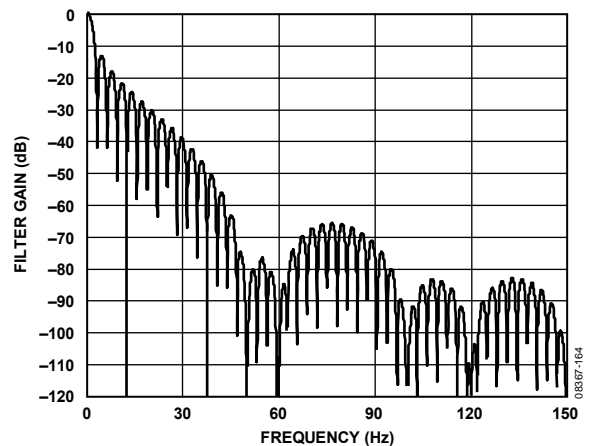

Figure 67. Filter Response for Average + Decimate Filter (Sinc³ Filter, FS[9:0] = 96, Average by 16)

FAST SETTLING MODE (CHOP ENABLED)

Chop can be enabled in the fast settling mode. With chop enabled, the ADC offset and offset drift are minimized. The analog input pins are continuously swapped. With the analog input pins connected in one direction, the settling time of the sinc filter is allowed and a conversion is recorded. The analog input pins are then inverted, and another settled conversion is obtained. Subsequent conversions are averaged so that the offset is minimized. This continuous swapping of the analog input pins and the averaging of subsequent conversions means that the offset drift is also minimized.

Chopping does not change the output data rate. However, the settling time equals

$$t_{SETTLE} = 2/f_{ADC}$$

Consequently, if chop is enabled, the sinc⁴ filter is selected, FS[9:0] is set to 6, averaging by 16 is enabled, and the output data rate is equal to 42.1 Hz. Therefore, the conversion time equals 1/42.10 Hz or 23.75 ms, and the settling time is equal to 47.5 ms.

SUMMARY OF FILTER OPTIONS

The AD7193 has several filter options. The filter that is chosen affects the output data rate, settling time, the rms noise, and the 50 Hz/60 Hz rejection.

Table 36 shows some sample configurations and the corresponding performance in terms of throughput, settling time, and 50 Hz/60 Hz rejection.

Table 36. Filter Summary¹

| Filter | FS[9:0] | Output Data Rate (Hz) | Settling Time (ms) | Throughput ² (Hz) | REJ60 | 50 Hz Rejection (dB) ³ |
|---|---------|-----------------------|--------------------|------------------------------|-------|-----------------------------------|
| Sinc ⁴ , Chop Disabled ⁴ | 1 | 4800 | 0.83 | 1200 | 0 | No 50 Hz or 60 Hz rejection |
| Sinc ⁴ , Chop Disabled | 5 | 960 | 4.17 | 240 | 0 | No 50 Hz or 60 Hz rejection |
| Sinc ³ , Chop Disabled | 5 | 960 | 3.125 | 320 | 0 | No 50 Hz or 60 Hz rejection |
| Sinc ⁴ , Chop Disabled | 480 | 10 | 400 | 2.5 | 0 | 120 dB (50 Hz and 60 Hz) |
| Sinc ³ , Chop Disabled | 480 | 10 | 300 | 3.33 | 0 | 100 dB (50 Hz and 60 Hz) |
| Sinc ⁴ , Chop Disabled | 96 | 50 | 80 | 12.5 | 0 | 120 dB (50 Hz only) |
| Sinc ⁴ , Chop Disabled | 96 | 50 | 80 | 12.5 | 1 | 82 dB (50 Hz and 60 Hz) |
| Sinc ³ , Chop Disabled | 96 | 50 | 60 | 16.7 | 0 | 95 dB (50 Hz only) |
| Sinc ³ , Chop Disabled | 96 | 50 | 60 | 16.7 | 1 | 67 dB (50 Hz and 60 Hz) |
| Sinc ⁴ , Chop Disabled | 80 | 60 | 66.67 | 15 | 0 | 120 dB (60 Hz only) |
| Sinc ³ , Chop Disabled | 80 | 60 | 50 | 20 | 0 | 95 dB (60 Hz only) |
| Sinc ⁴ , Chop Disabled, Zero Latency | 96 | 12.5 | 80 | 12.5 | 0 | 120 dB (50 Hz only) |
| Sinc ⁴ , Chop Disabled, Zero Latency | 96 | 12.5 | 80 | 12.5 | 1 | 82 dB (50 Hz and 60 Hz) |
| Sinc ⁴ , Chop Disabled, Zero Latency | 80 | 15 | 66.67 | 15 | 0 | 120 dB (60 Hz only) |
| Sinc ⁴ , Chop Enabled | 96 | 12.5 | 160 | 6.25 | 1 | 80 dB (50 Hz and 60 Hz) |
| Sinc ³ , Chop Enabled | 96 | 16.7 | 120 | 8.33 | 1 | 67 dB (50 Hz and 60 Hz) |
| Fast Settling (Sinc ⁴ , Chop Disabled, Average by 16) | 96 | 2.63 | 380 | 2.63 | 1 | 100 dB (50 Hz and 60 Hz) |
| Fast Settling (Sinc ⁴ , Chop Disabled, Average by 16) | 96 | 2.78 | 360 | 2.78 | 1 | 94 dB (50 Hz and 60 Hz) |
| Fast Settling (Sinc ⁴ , Chop Disabled, Average by 16) | 5 | 50.53 | 19.79 | 50.53 | 0 | 40 dB (60 Hz only) |
| Fast Settling (Sinc ³ , Chop Disabled, Average by 16) | 5 | 53.33 | 18.75 | 53.33 | 0 | 40 dB (60 Hz only) |
| Fast Settling (Sinc ⁴ , Chop Disabled, Average by 16) | 6 | 42.10 | 23.75 | 42.1 | 0 | 40 dB (50 Hz only) |
| Fast Settling (Sinc ³ , Chop Disabled, Average by 16) | 6 | 44.44 | 22.5 | 44.44 | 0 | 40 dB (50 Hz only) |

¹ These calculations assume a 4.92 MHz stable master clock.

² Throughput is the rate at which conversions are available when several channels are enabled. In zero latency mode, the output data rate and throughput are equal.

³ For fast settling mode, the 50 Hz/60 Hz rejection is measured in a band of ± 0.5 Hz around 50 Hz and/or 60 Hz. For all other modes, a region of ± 1 Hz around 50 Hz and/or 60 Hz is used.

⁴ For output data rates greater than 1 kHz, the sinc⁴ filter is recommended.

GROUNDING AND LAYOUT

Because the analog inputs and reference inputs are differential, most of the voltages in the analog modulator are common-mode voltages. The high common-mode rejection of the part removes common-mode noise on these inputs. The analog and digital supplies to the AD7193 are independent and separately pinned out to minimize coupling between the analog and digital sections of the device. The digital filter provides rejection of broadband noise on the power supplies, except at integer multiples of the modulator sampling frequency.

Connect an RC filter to each analog input pin to provide rejection at the modulator sampling frequency. A 100 Ω resistor in series with each analog input, a 0.1 μF capacitor between the analog input pins, and a 0.01 μF capacitor from each analog input to AGND are advised.

The digital filter also removes noise from the analog and reference inputs provided that these noise sources do not saturate the analog modulator. As a result, the AD7193 is more immune to noise interference than a conventional high resolution converter. However, because the resolution of the AD7193 is so high and the noise levels from the converter so low, care must be taken with regard to grounding and layout.

The printed circuit board (PCB) that houses the ADC must be designed so that the analog and digital sections are separated and confined to certain areas of the board. This facilitates the use of ground planes that can be easily separated. A minimum etch technique is generally best for ground planes because it gives the best shielding.

Although the AD7193 has separate pins for analog and digital ground, the AGND and DGND pins are tied together internally via the substrate. Therefore, the user must not tie these two pins to separate ground planes unless the ground planes are connected together near the AD7193.

In systems in which the AGND and DGND are connected somewhere else in the system (that is, the power supply of the system), they should not be connected again at the AD7193 because a ground loop results. In these situations, it is recommended that the ground pins of the AD7193 be tied to the AGND plane.

In any layout, the user must keep in mind the flow of currents in the system, ensuring that the paths for all currents are as close as possible to the paths the currents took to reach their destinations. Avoid forcing digital currents to flow through the AGND.

Avoid running digital lines under the device because this couples noise onto the die and allows the analog ground plane to run under the AD7193 to prevent noise coupling. The power supply lines to the AD7193 must use as wide a trace as possible to provide low impedance paths and reduce the effects of glitches on the power supply line. Shield fast switching signals like clocks with digital ground to prevent radiating noise to other sections of the board and never run clock signals near the analog inputs. Avoid crossover of digital and analog signals. Run traces on opposite sides of the board at right angles to each other. This reduces the effects of feedthrough through the board. A microstrip technique is by far the best but is not always possible with a double-sided board. In this technique, the component side of the board is dedicated to ground planes, whereas signals are placed on the solder side.

Good decoupling is important when using high resolution ADCs. Decouple all analog supplies with 10 μF tantalum capacitors in parallel with 0.1 μF capacitors to AGND. To achieve the best results from these decoupling components, place them as close as possible to the device, ideally right up against the device. Decouple all logic chips with 0.1 μF ceramic capacitors to DGND. In systems in which a common supply voltage is used to drive both the AV_{DD} and DV_{DD} of the AD7193, it is recommended that the system AV_{DD} supply be used. For this supply, place the recommended analog supply decoupling capacitors between the AV_{DD} pin of the AD7193 and AGND and the recommended digital supply decoupling capacitor between the DV_{DD} pin of the AD7193 and DGND.

APPLICATIONS INFORMATION

The AD7193 provides a low cost, high resolution analog-to-digital function. Because the analog-to-digital function is provided by a Σ - Δ architecture, the part is more immune to noisy environments, making it ideal for use in sensor measurement and industrial and process control applications.

FLOWMETER

Figure 68 shows the AD7193 being used in a flowmeter application that consists of two pressure transducers with the rate of flow being equal to the pressure difference. The pressure transducers are arranged in a bridge network and give a differential output voltage between its OUT+ and OUT- terminals. With rated full-scale pressure (in this case 300 mmHg) on the transducer, the differential output voltage is 3 mV/V of the input voltage (that is, the voltage between the IN+ and IN- terminals).

Assuming a 5 V excitation voltage, the full-scale output range from the transducer is 15 mV. The excitation voltage for the bridge can be used to directly provide the reference for the ADC, because the reference input range includes the supply voltage.

A second advantage of using the AD7193 in transducer-based applications is that the bridge power-down switch can be fully utilized in low power applications. The bridge power-down switch is connected in series with the cold side of the bridges. In normal operation, the switch is closed and measurements are taken. In applications where power is of concern, the AD7193 can be placed in power-down mode, thus significantly reducing the

power consumed in the application. In addition, the bridge power-down switch can be opened while the AD7193 is in power-down mode, thus avoiding unnecessary power consumption by the front-end transducers. When the parts are taken out of power-down mode and the bridge power-down switch is closed, the user should ensure that the front-end circuitry is fully settled before attempting a read from the AD7193.

In Figure 68, temperature compensation is performed using a thermistor. In addition, the reference voltage for the temperature measurement is derived from a precision resistor in series with the thermistor. This allows a ratiometric measurement so that variation of the excitation voltage has no effect on the measurement (it is the ratio of the precision reference resistance to the thermistor resistance that is measured)

For simplicity, external filters are not shown in Figure 68; however, an RC antialias filter must be included on each analog input. This is required because the on-chip digital filter does not provide any rejection around the modulator sampling frequency or multiples of this frequency. Suitable values are a 100 Ω resistor in series with each analog input, a 0.1 μ F capacitor between the analog input pins, and a 0.01 μ F capacitor from each analog input pin to AGND.

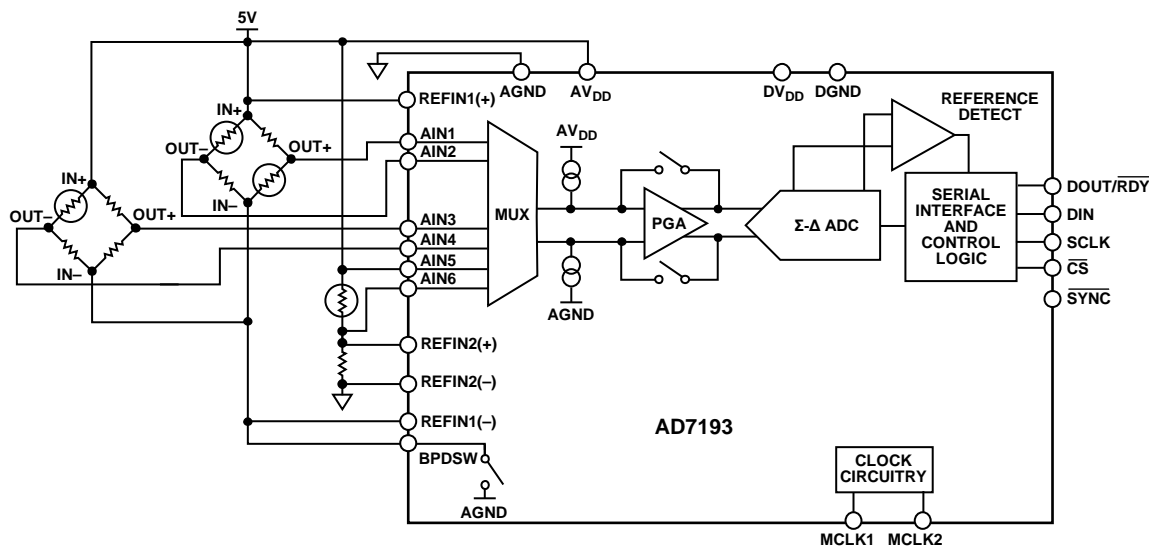
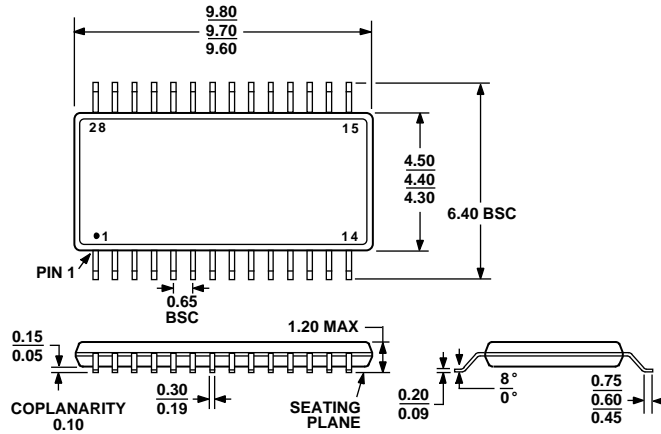

Figure 68. Typical Application (Flowmeter)

OUTLINE DIMENSIONS



COMPLIANT TO JEDEC STANDARDS MO-153-AE

Figure 69. 28-Lead Thin Shrink Small Outline Package [TSSOP] (RU-28)
Dimensions shown in millimeters

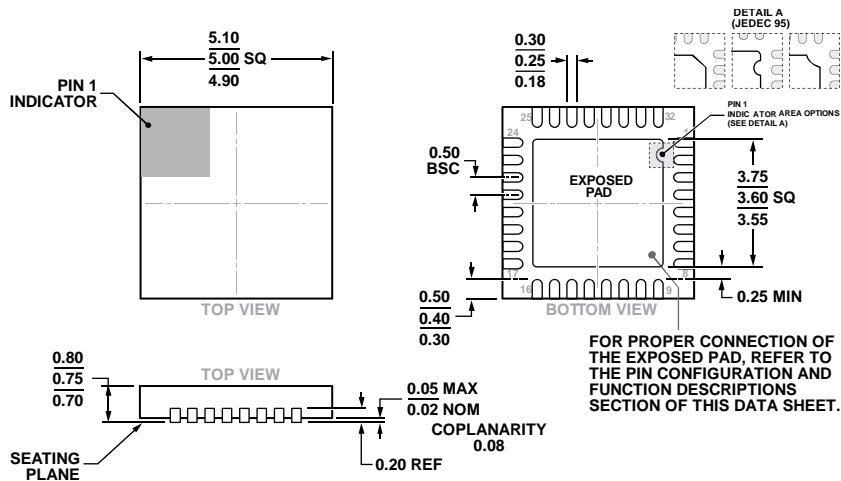

COMPLIANT TO JEDEC STANDARDS MO-220-WHHD-5.

Figure 70. 32-Lead Lead Frame Chip Scale Package [LFCSP] 5 mm x 5 mm Body and 0.75 mm Package Height (CP-32-12)
Dimensions shown in millimeters

ORDERING GUIDE

| Model ¹ | Temperature Range | Package Description | Package Option |
|--------------------|-------------------|---------------------|----------------|
| AD7193BRUZ | -40°C to +105°C | 28-Lead TSSOP | RU-28 |
| AD7193BRUZ-REEL | -40°C to +105°C | 28-Lead TSSOP | RU-28 |
| AD7193BCPZ | -40°C to +105°C | 32-Lead LFCSP | CP-32-12 |
| AD7193BCPZ-RL | -40°C to +105°C | 32-Lead LFCSP | CP-32-12 |
| AD7193BCPZ-RL7 | -40°C to +105°C | 32-Lead LFCSP | CP-32-12 |
| EVAL-AD7193EBZ | | Evaluation Board | |

¹ Z = RoHS Compliant Part.

NOTES

Данный компонент на территории Российской Федерации

Вы можете приобрести в компании MosChip.

Для оперативного оформления запроса Вам необходимо перейти по данной ссылке:

<http://moschip.ru/get-element>

Вы можете разместить у нас заказ для любого Вашего проекта, будь то серийное производство или разработка единичного прибора.

В нашем ассортименте представлены ведущие мировые производители активных и пассивных электронных компонентов.

Нашей специализацией является поставка электронной компонентной базы двойного назначения, продукции таких производителей как XILINX, Intel (ex.ALTERA), Vicor, Microchip, Texas Instruments, Analog Devices, Mini-Circuits, Amphenol, Glenair.

Сотрудничество с глобальными дистрибьюторами электронных компонентов, предоставляет возможность заказывать и получать с международных складов практически любой перечень компонентов в оптимальные для Вас сроки.

На всех этапах разработки и производства наши партнеры могут получить квалифицированную поддержку опытных инженеров.

Система менеджмента качества компании отвечает требованиям в соответствии с ГОСТ Р ИСО 9001, ГОСТ РВ 0015-002 и ЭС РД 009

Офис по работе с юридическими лицами:

105318, г.Москва, ул.Щербаковская д.3, офис 1107, 1118, ДЦ «Щербаковский»

Телефон: +7 495 668-12-70 (многоканальный)

Факс: +7 495 668-12-70 (доб.304)

E-mail: info@moschip.ru

Skype отдела продаж:

moschip.ru

moschip.ru_4

moschip.ru_6

moschip.ru_9