

LUXEON Rebel, White & PC Amber

Styling solution for front turn and side marker applications

LUXEON Rebel LEDs for automotive has the longest history in high power exterior lighting applications that are specifically designed and tested to meet and exceed expectations for reliability, performance and lifetime in all vehicle applications. LUXEON Rebel meets both SAE and ECE color specifications and provides finer granularity than existing systems.

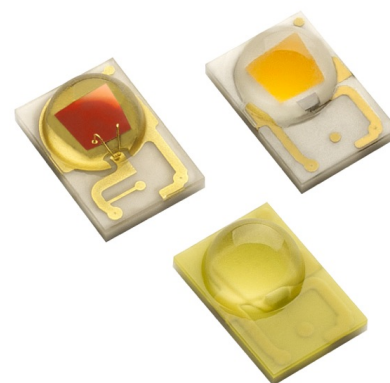

FEATURES AND BENEFITS

Drive at maximum current for upto 230 lumens for reduced LED count

Low thermal resistance for lower heat sink costs

Electrically isolated thermal pad to reduce thermal management engineering costs

AEC-Q101C qualified and PPAP documentation available

PRIMARY APPLICATIONS

Back-up

Daytime Running Lights

- Position

Side Marker

Turn

Table of Contents

General Information	2
Product Nomenclature	2
LED Lifetime Characteristics	2
Environmental Compliance	2
Flux Characteristics	3
Optical Characteristics	3
Electrical Characteristics	4
Absolute Maximum Ratings	5
Absolute Minimum Ratings	5
JEDEC Moisture Sensitivity	5
Reflow Soldering Characteristics	6
Mechanical Dimensions	7
Pad Configuration	8
Solder Pad Design	8
Wavelength Characteristics	9
Typical Light Output Characteristics over Temperature	10
Typical Forward Current Characteristics	11
Typical Relative Luminous Flux	12
Current Derating Curves	13
Typical Radiation Patterns	15
Emitter Pocket Tape Packaging	17
Emitter Reel Packaging	18
Automotive Product Binning and Labeling	19
Color Bin Structure	20
Graphical Presentation of LUXEON Rebel Automotive White xy Coordinates	21
LUXEON Rebel PC Amber Color Bin Structure	22
Forward Voltage Bins	22

General Information

Product Nomenclature

LUXEON Rebel is tested and binned at 350mA.

The part number designation is explained as follows:

L X M A - **A B C D** - **E F G H**

Where:

- A — designates radiation pattern (value P for Lambertian)
- B — designates color variant (W for Automotive White, L for PC Amber)
- C — designates color variant (0 for Automotive White)
- D — designates technology (1 for Automotive White; 2 for PC Amber)
- E — reserved for future product offerings
- FGH — minimum luminous flux (lm) performance

Products tested and binned at 350mA follow the part numbering scheme:

L X M A - P x 0 x - x x x x

LED Lifetime Characteristics

Lifetime for solid state lighting devices (LEDs) is defined in terms of lumen maintenance – the percentage of initial light output remaining after a specified period of time – and light output failures such as shorts. These two degradation modes are both considered in Lumileds LED lifetime assessment.

LED lifetime performance is based on independent test data, Lumileds historical data from tests run on similar material systems, and internal product reliability testing.

Please contact your Lumileds Sales Representative for LUXEON LED product lifetime assessment for your operational conditions.

Environmental Compliance

Lumileds is committed to providing environmentally friendly products to the solid-state lighting market. The LUXEON Rebel is compliant to the European Union directives on the restriction of hazardous substances in electronic equipment, namely the REACH, ELV, and RoHS directives. Lumileds will not intentionally add the following restricted materials to the LUXEON Rebel: lead, mercury, cadmium, hexavalent chromium, polybrominated biphenyls (PBB) or polybrominated diphenyl ethers (PBDE).

Flux Characteristics

Flux Characteristics for LUXEON Rebel, Junction Temperature, $T_j = 25^\circ\text{C}$ [4]

Table 1.

Performance at Binning Current				Typical Performance at Maximum Current	
Color	Part Number [5]	Minimum Luminous Flux (lm) Φ_V [1] [3]	Binning Current (mA)	Typical Luminous Flux (lm) Φ_V [2] [3]	Maximum Current (mA)
Automotive White	LXMA-PW01-0110	110	350	199	700
	LXMA-PW01-0120	120	350	216	700
	LXMA-PW01-0130	130	350	233	700
PC Amber	LXMA-PL02-0090	90	350	170	700
	LXMA-PL02-0100	100	350	187	700
	LXMA-PL02-0110	110	350	204	700

Note for Table 1:

1. Minimum luminous flux performance guaranteed within published operating conditions. Lumileds maintains a tolerance of $\pm 6.5\%$ on flux measurements.
2. Typical luminous flux or radiometric power performance when device is operated within published operating conditions.
3. LUXEON Rebel products with even higher luminous flux and radiometric power levels will become available in the future. Please consult Lumileds for more information.
4. Junction Temperature is estimated based on instant measurement at thermal pad temperature of 25°C .
5. Please contact Lumileds for information on custom part numbers.

Optical Characteristics

Lambertian LUXEON Rebel at Test Current [1], Junction Temperature, $T_j = 25^\circ\text{C}$ [9]

Table 2.

Color	Color Temperature [2], [3] CCT			Typical Spectral Half-width [5] (nm) $\Delta\lambda_{1/2}$	Typical Temperature Coefficient of Dominant Wavelength (nm/ $^\circ\text{C}$) $\Delta\lambda_D / \Delta T_j$	Typical Total Included Angle [6] $\theta_{0.90V}$	Typical Viewing Angle [7] $2\theta_{1/2}$
	Minimum	Typical	Maximum				
Automotive White [8]	3800 K	5500 K	6300 K	—	—	160°	120°
PC Amber [8]	588.0 nm	591.0 nm	592.0 nm	80	0.10	160°	120°

Notes for Table 2:

1. LUXEON Rebel is tested and binned at 350mA.
2. Dominant wavelength is derived from the CIE 1931 Chromaticity diagram and represents the perceived color. Lumileds maintains a tolerance of ± 0.5 nm for dominant wavelength measurements.
3. CCT $\pm 5\%$ tester tolerance.
4. CRI (Color Rendering Index) for white product types is 70 typical.
5. Spectral width at 1/2 of the peak intensity.
6. Total angle at which 90% of total luminous flux is captured.
7. Viewing angle is the off axis angle from lamp centerline where the luminous intensity is 1/2 of the peak value.
8. All white and PC Amber products are built with Indium Gallium Nitride (InGaN).
9. Junction Temperature is estimated based on instant measurement at thermal pad temperature of 25°C .

Electrical Characteristics

Electrical Characteristics at 350mA for LUXEON Rebel, Junction Temperature, $T_j = 25^\circ\text{C}$

Table 3.

Part Number	Forward Voltage V_f ^[1] (V)			Typical Dynamic Resistance ^[4] (Ω) R_D	Typical Temperature Coefficient of Forward Voltage ^[2] (mV/ $^\circ\text{C}$) $\Delta V_F / \Delta T_J$	Typical Thermal Resistance Junction to Thermal Pad ^[3] ($^\circ\text{C}/\text{W}$) $R\theta_{J-C}$
	Minimum	Typical	Maximum			
LXMA-PW01-0110	2.55	2.92	3.27	.30	-2.0 to -4.0	10
LXMA-PW01-0120	2.55	2.92	3.27	.30	-2.0 to -4.0	10
LXMA-PW01-0130	2.55	2.92	3.27	.30	-2.0 to -4.0	10
LXMA-PL02-0090	2.55	2.92	3.27	0.36	-2.0 to -4.0	10
LXMA-PL02-0100	2.55	2.92	3.27	0.36	-2.0 to -4.0	10
LXMA-PL02-0110	2.55	2.92	3.27	0.36	-2.0 to -4.0	10

Notes for Table 3:

1. Lumileds maintains a tolerance of $\pm 0.06\text{V}$ on forward voltage measurements.
2. Measured between $T_j = 25^\circ\text{C} - 110^\circ\text{C}$ at $I_f = 350\text{mA}$.
3. Does not include wall plug efficiency.
4. Dynamic resistance is the inverse of the slope in the linear forward voltage model for LEDs. See Forward Voltage vs. Forward Current curves.

Typical Electrical Characteristics at 700mA for LUXEON Rebel, Junction Temperature, $T_j = 25^\circ\text{C}$

Table 4.

Part Number	Typical Forward Voltage V_f ^[1] (V)
LXMA-PW01-0110	3.06
LXMA-PW01-0120	3.06
LXMA-PW01-0130	3.06
LXMA-PL02-0090	3.06
LXMA-PL02-0100	3.06
LXMA-PL02-0110	3.06

Notes for Table 4:

1. Lumileds maintains a tolerance of $\pm 0.06\text{V}$ on forward voltage measurements.

Absolute Maximum Ratings

Table 5a.

Parameter	Automotive White	PC Amber
DC Forward Current (mA)	700	700
Peak Pulsed Forward Current (mA)	1000	700
Average Forward Current (mA)	700	700
ESD Sensitivity ^[5]	8kV HBM, 400V MM	8kV HBM, 400V MM
LED Junction Temperature ^{[1] [3] [4]}	150°C	135°C
Operating Case Temperature ^[4]	-40°C - 150°C	-40°C - 135°C
Storage Temperature	-40°C - 135°C	-40°C - 135°C
Soldering Temperature	JEDEC 020c 260°C	JEDEC 020c 260°C
Allowable Reflow Cycles	3	3
Autoclave Conditions	121°C at 2 ATM 100% Relative Humidity for 96 Hours Maximum	
Reverse Voltage (Vr)	See Note 2	See Note 2

Notes for Table 5a:

1. Proper current derating must be observed to maintain junction temperature below the maximum.
2. LUXEON Rebel LEDs are not designed to be driven in reverse bias.
3. LUXEON Rebel Automotive LEDs driven at maximum LED junction temperature will have limited lifetime.
4. Please consult with Lumileds for more information on maximum time durations and forward currents for these temperature ranges.
5. Measured using human body model and machine model (per AEC-Q101C).

Absolute Minimum Ratings

Table 5b.

Parameter	Automotive White	PC Amber
DC Forward Current (mA)	50	50

JEDEC Moisture Sensitivity

Table 6.

Level	Floor Life		Soak Requirements	
			Standard	
	Time	Conditions	Time	Conditions
1	unlimited	≤ 30°C / 85% RH	168 Hrs. + 5 / -0 Hrs.	85°C / 85% RH

Reflow Soldering Characteristics

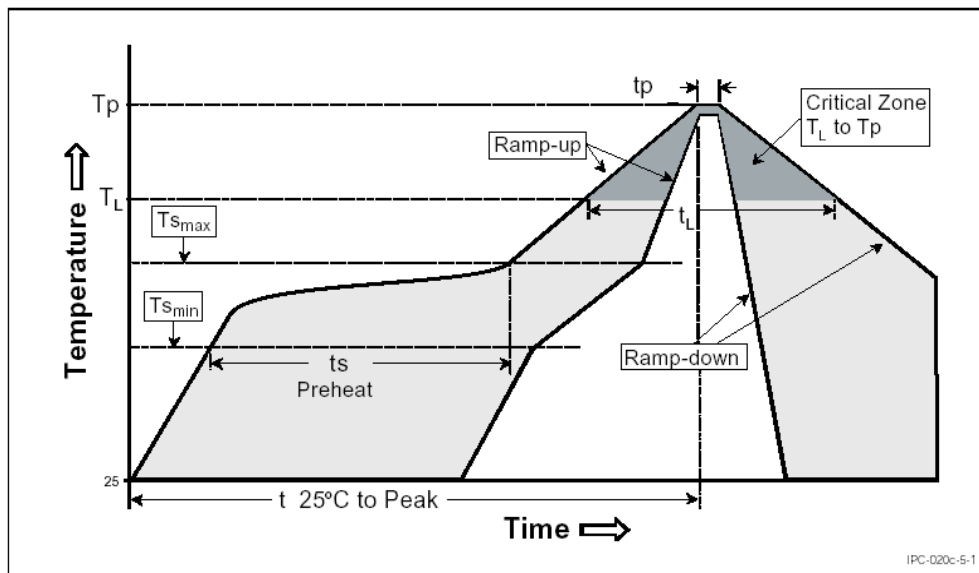

Temperature Profile for Table 7.

Table 7.

Profile Feature	Lead Free Assembly
Average Ramp-Up Rate ($T_{s_{max}}$ to T_p)	3°C / second max
Preheat Temperature Min ($T_{s_{min}}$)	150°C
Preheat Temperature Max ($T_{s_{max}}$)	200°C
Preheat Time ($t_{s_{min}}$ to $t_{s_{max}}$)	60 - 180 seconds
Temperature (T_L)	217°C
Time Maintained Above Temperature T_L (t_L)	60 - 150 seconds
Peak / Classification Temperature (T_p)	260°C
Time Within 5°C of Actual Peak Temperature (t_p)	20 - 40 seconds
Ramp - Down Rate	6°C / second max
Time 25°C to Peak Temperature	8 minutes max

Note for Table 7:

- All temperatures refer to the application Printed Circuit Board (PCB), measured on the surface adjacent to the package body.

Mechanical Dimensions

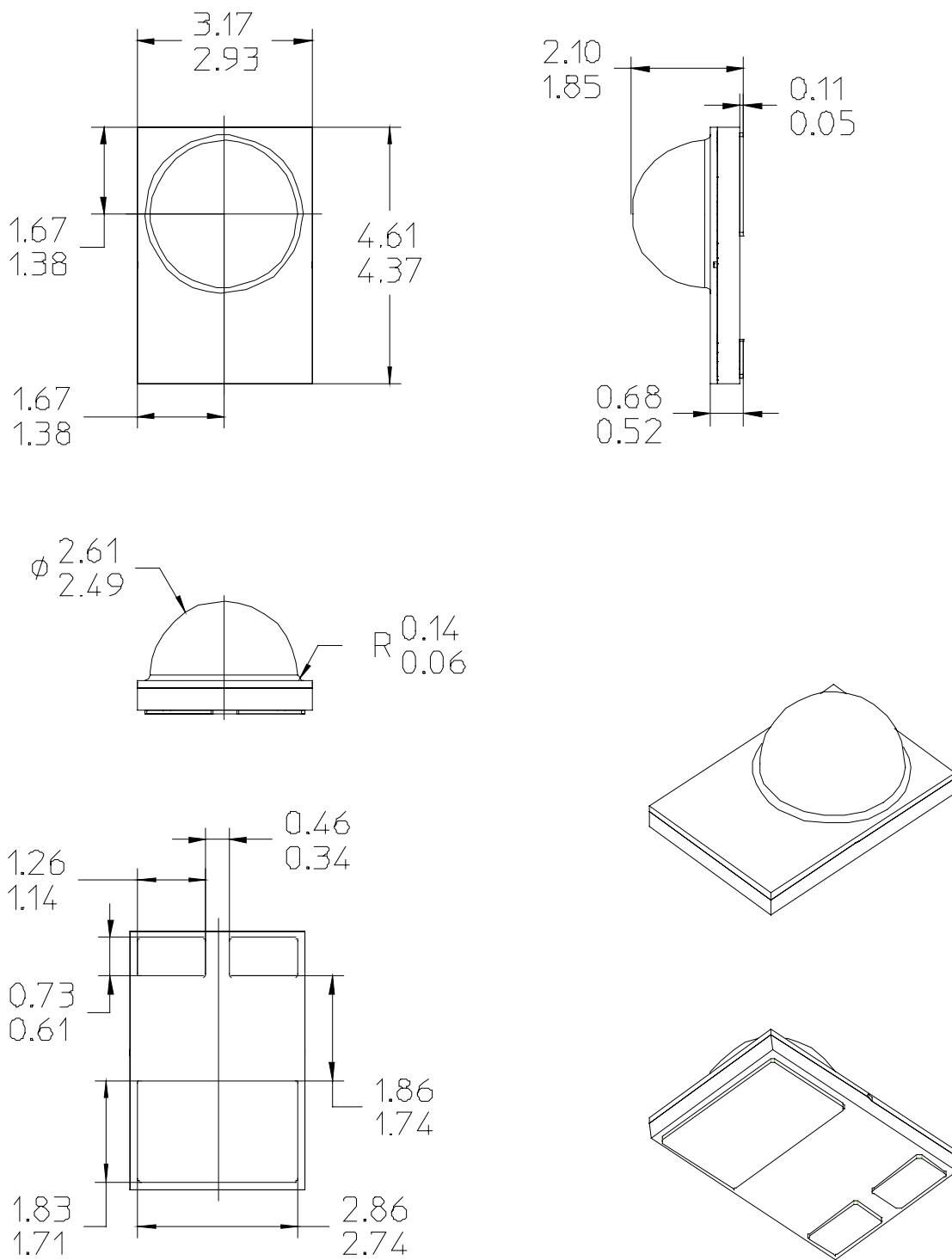
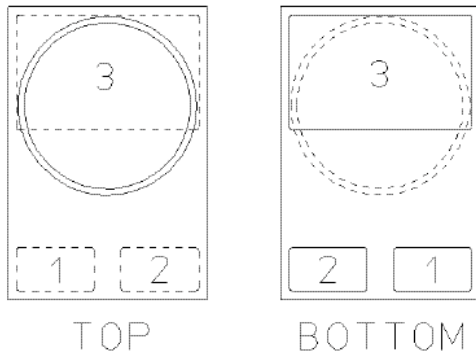

Figure 1. Package outline drawing.

Notes for Figure 1:

1. Do not handle the device by the lens—care must be taken to avoid damage to the lens or the interior of the device that can be damaged by excessive force to the lens.
2. Drawings not to scale.
3. All dimensions are in millimeters.
4. The Thermal Pad is electrically isolated from the Anode and Cathode contact pads.

Pad Configuration



PAD	FUNCTION
1	CATHODE
2	ANODE
3	THERMAL

Figure 2. Solder pad layout.

Note for Figure 2:

1. The Thermal Pad is electrically isolated from the Anode and Cathode contact pads.

Solder Pad Design

Application Brief AB32 provides details for recommended solder pad designs that provide low thermal resistance. These recommendations are not intended to represent specifications for soldering LUXEON Rebel LEDs. Drawing files are available at www.lumileds.com.

Wavelength Characteristics

Automotive White, Thermal Pad Temperature = 25°C

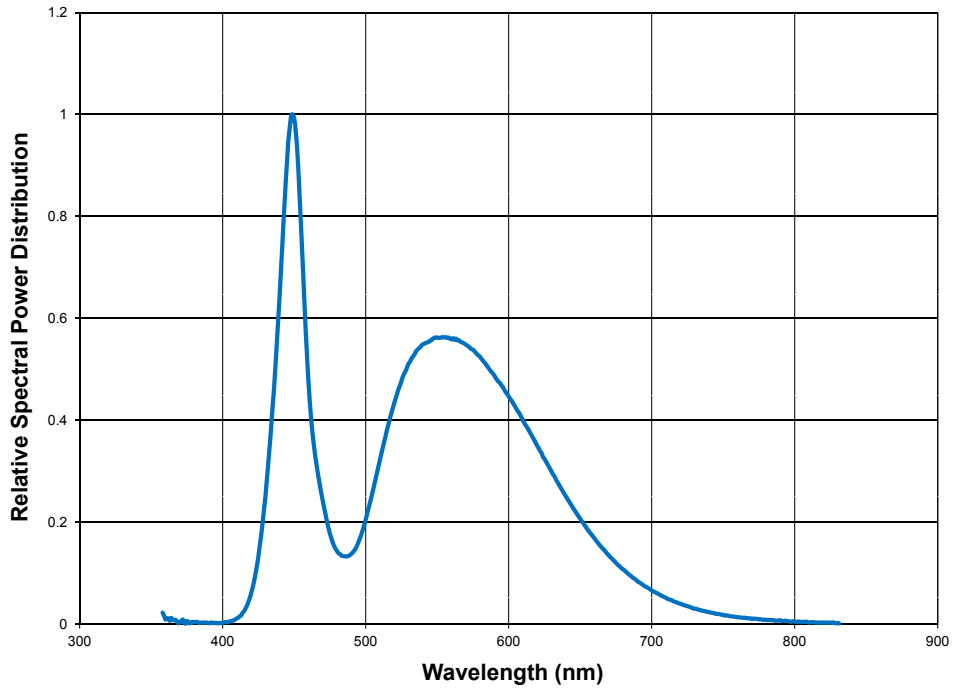

Figure 3. White color spectrum of typical CCT part, integrated measurement.

PC Amber, Thermal Pad Temperature = 25°C

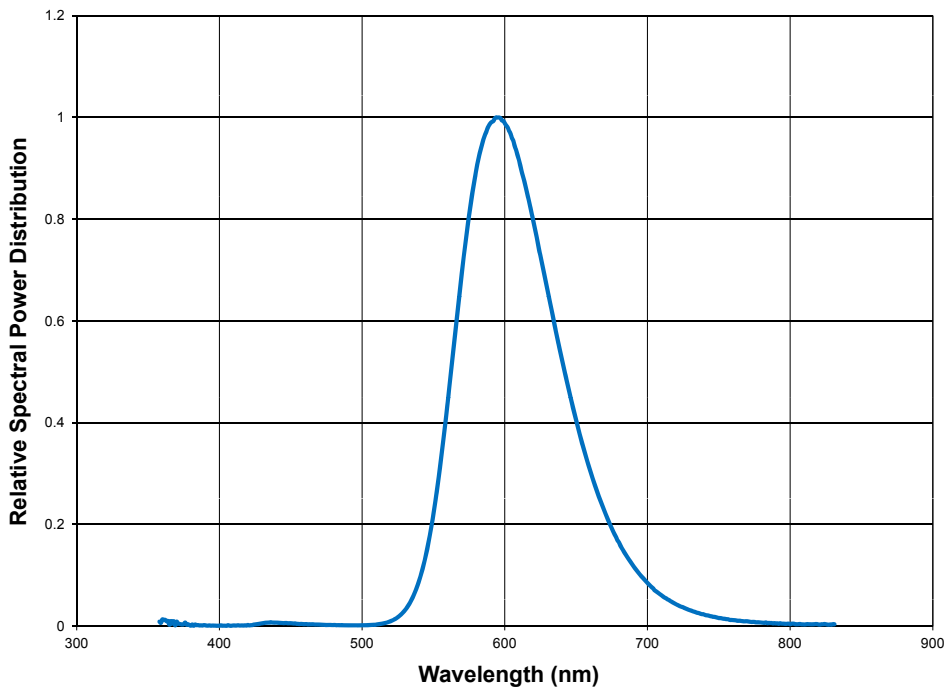
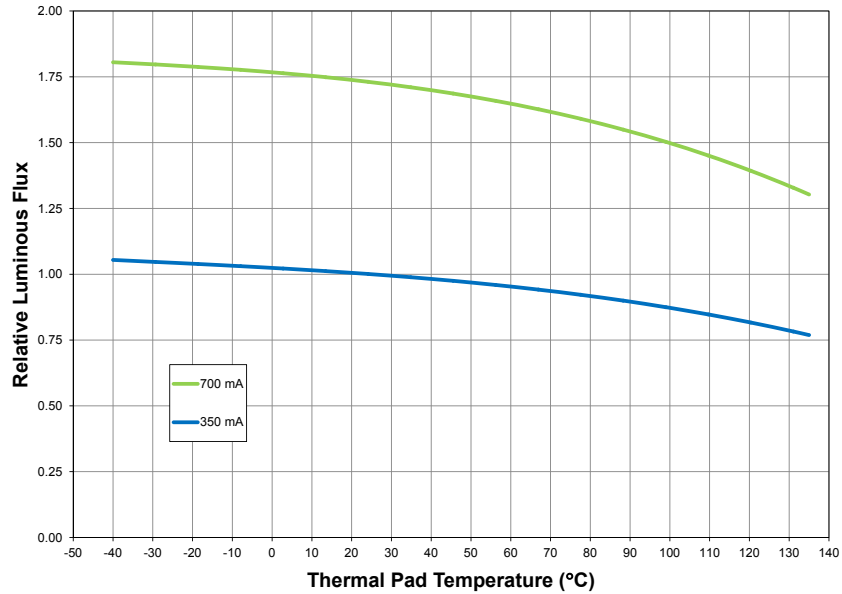

Figure 4. Relative intensity vs. wavelength.

Typical Light Output Characteristics over Temperature

Automotive White at 350mA and 700mA Current



I_f (mA)	Relative Luminous Flux vs. Thermal Pad Temperature for White
350	$y = -5.1449102370E-08x^3 - 9.3064817429E-06x^2 - 1.2437216494E-03x + 1.7671341979E+00$
700	$y = -2.9789330325E-08x^3 - 3.6512608470E-06x^2 - 8.5382653983E-04x + 1.0240931598E+00$

Figure 5. Relative light output vs. thermal pad temperature for Automotive White (Monopulse Measurement, H/C factor is color bin dependent; 5000K to 6300K shown).

PC Amber at 350mA and 700mA Currents

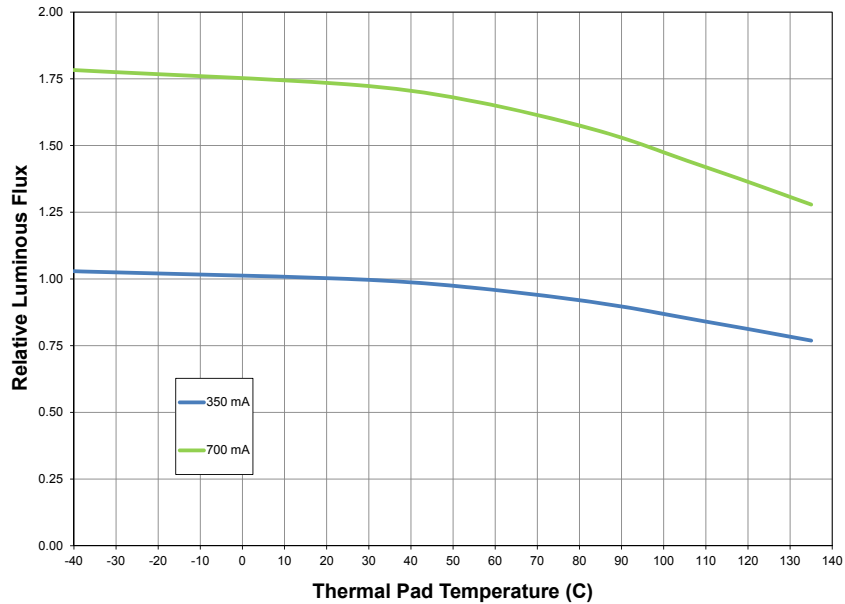

I_f (mA)	Relative Luminous Flux vs. Thermal Pad Temperature for PC Amber
350	$y = -1.4816286787E-08x^3 - 1.7936609071E-05x^2 - 9.8476385979E-04x + 1.7706546435E+00$
700	$y = -7.109636E-09x^3 - 9.126629E-06x^2 - 5.274710E-04x + 1.021626E+00$

Figure 6. Relative light output vs. thermal pad temperature for PC Amber (Monopulse Measurement).

Typical Forward Current Characteristics

Automotive White, Thermal Pad Temperature = 25°C and 85°C

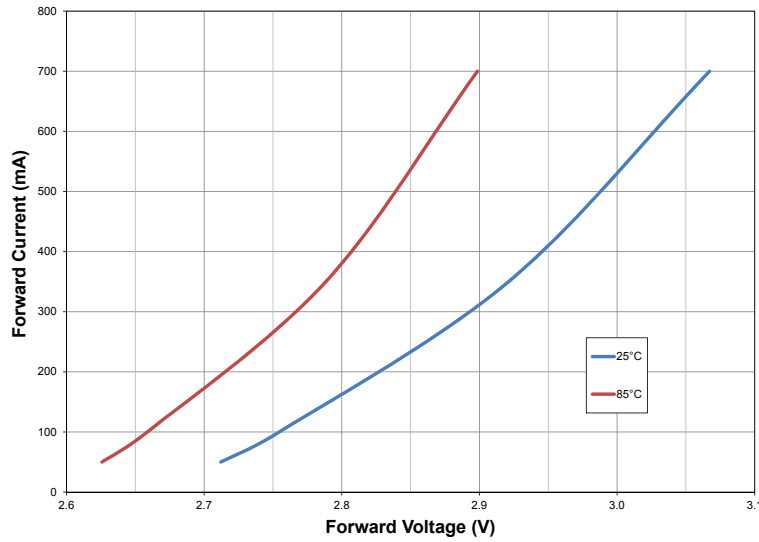

Deg. C	Forward Current vs. Forward Voltage for White
25	$y = 3.7276910548E+03x^3 - 2.9719986092E+04x^2 + 8.0094622572E+04x - 7.2932726469E+04$
85	$y = 9.8523510878E+03x^3 - 7.7003195660E+04x^2 + 2.0208404564E+05x - 1.7802985112E+05$

Figure 7. Forward current vs. forward voltage for Automotive White (Monopulse Measurement) at various thermal pad temperatures.

PC Amber, Thermal Pad Temperature = 25°C and 85°C

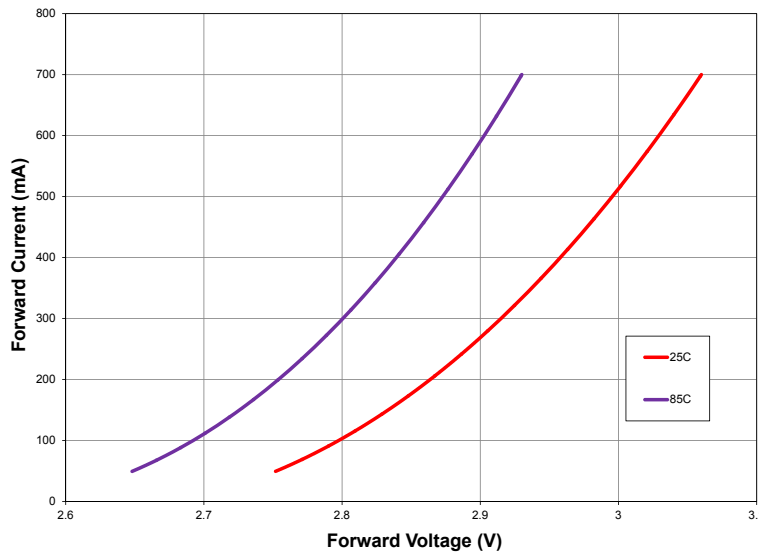

Deg. C	Forward Current vs. Forward Voltage for White
25	$y = 1.1826037356E+03x^3 - 6.3580775970E+03x^2 + 9.0762180561E+03x - 1.4234558559E+03$
85	$y = 2.2710146521E+03x^3 - 1.3898700425E+04x^2 + 2.6793681113E+04x - 1.5611127474E+04$

Figure 8. Forward current vs. forward voltage for PC Amber (Monopulse Measurement) at various thermal pad temperatures.

Note for Figures 7 & 8:

- Driving these high power devices at currents less than the test conditions (350mA and 700mA) may produce unpredictable results and may be subject to variation in performance. Pulse width modulation (PWM) is recommended for dimming effects.

Typical Relative Luminous Flux

Relative Luminous Flux vs. Forward Current for Automotive White,
Thermal Pad Temperature = 25°C and 85°C

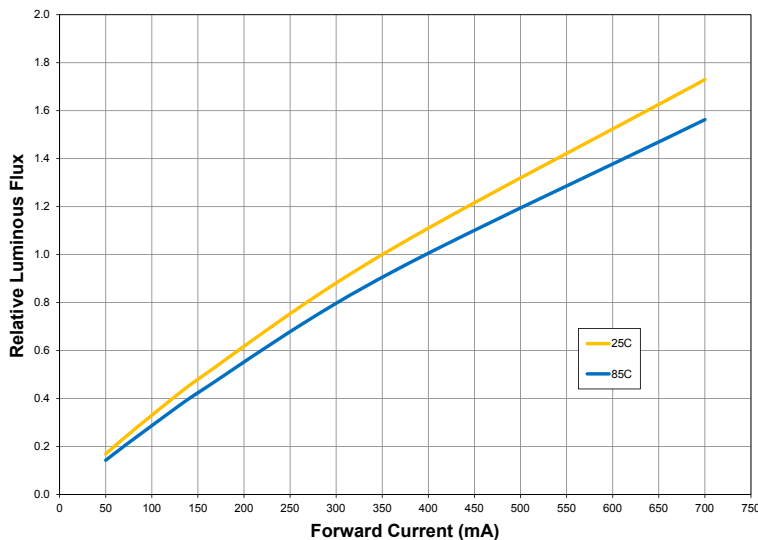

Deg. C	Relative Luminous Flux vs. Forward Current for White
25	$y = 1.2033748436E-09x^3 - 2.3759821150E-06x^2 + 3.5471254653E-03x - 2.0893502499E-03$
85	$y = 6.0395835128E-10x^3 - 1.6883391889E-06x^2 + 3.1322147999E-03x - 9.8387042880E-03$

Figure 9. Relative luminous flux vs. forward current for Automotive White (Monopulse).

Typical Relative Luminous Flux vs. Forward Current for PC Amber,
Thermal Pad Temperature = 25°C and 85°C

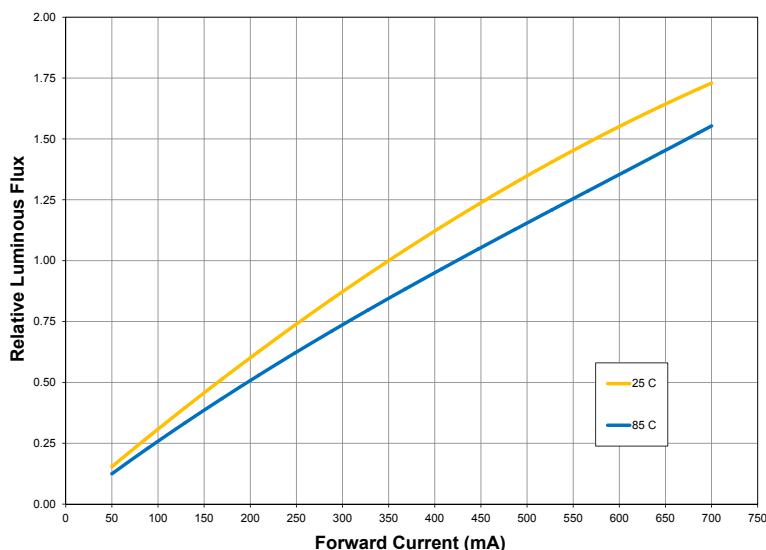

Deg. C	Relative Luminous Flux vs. Forward Current for PC Amber
25	$y = -1.2337829033E-10x^3 - 9.9788605910E-07x^2 + 3.2376013183E-03x - 5.6895985448E-03$
85	$y = 8.5529596534E-10x^3 - 1.5233025226E-06x^2 + 2.8895742849E-03x - 1.6291528532E-02$

Figure 10. Relative luminous flux vs. forward current for PC Amber (Monopulse).

Current Derating Curves

Current Derating Curve for 350mA Drive Current for Automotive White

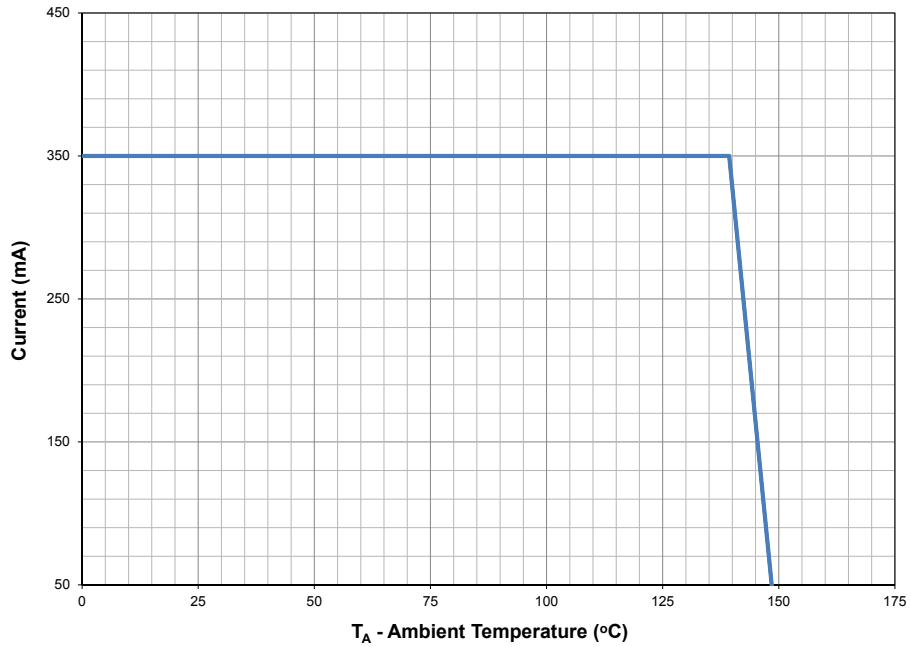

Figure 11. Maximum forward current vs. ambient temperature, based on $T_{JMAX} = 150^{\circ}\text{C}$ for Automotive White.

Current Derating Curve for 350mA Drive Current for PC Amber

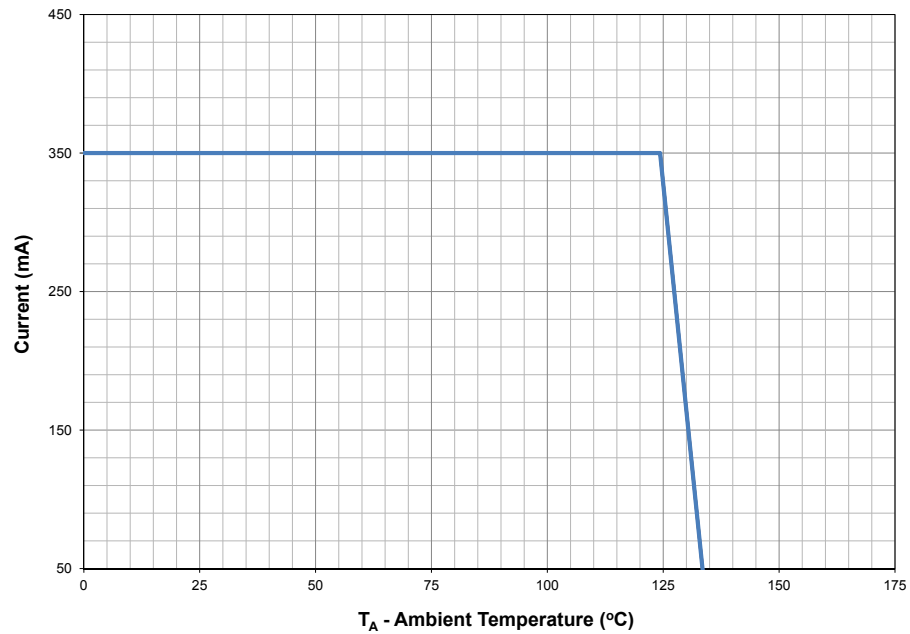

Figure 12. Maximum forward current vs. ambient temperature, based on $T_{JMAX} = 135^{\circ}\text{C}$ for PC Amber.

Notes for Figures 11 and 12:

1. LEDs operating at max junction temperature may have shorter lifetimes.

Current Derating Curve for 700mA Drive Current for Automotive White

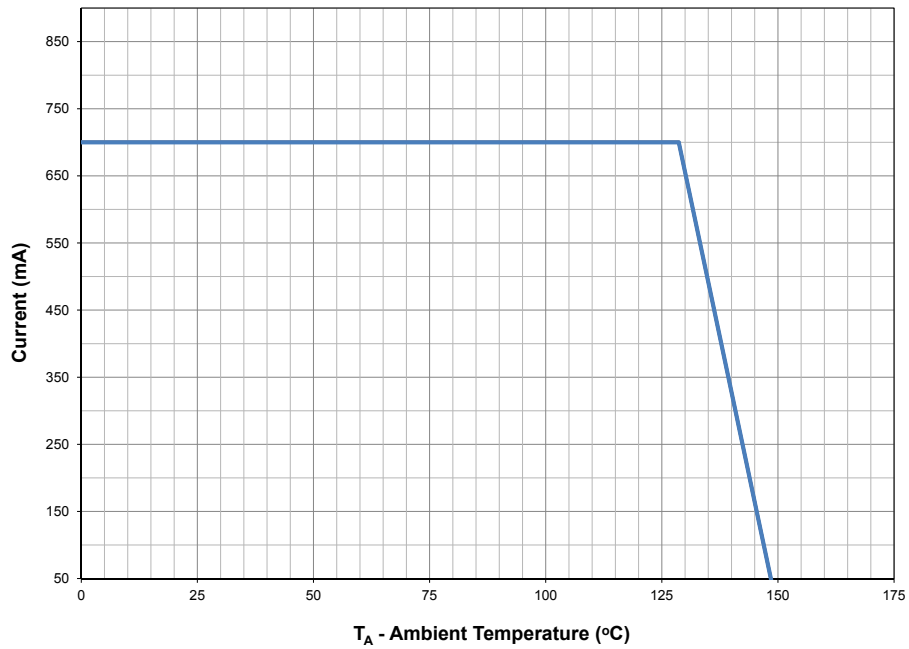

Figure 13. Maximum forward current vs. ambient temperature, based on $T_{JMAX} = 150^{\circ}\text{C}$ for Automotive White.

Current Derating Curve for 700mA Drive Current for PC Amber

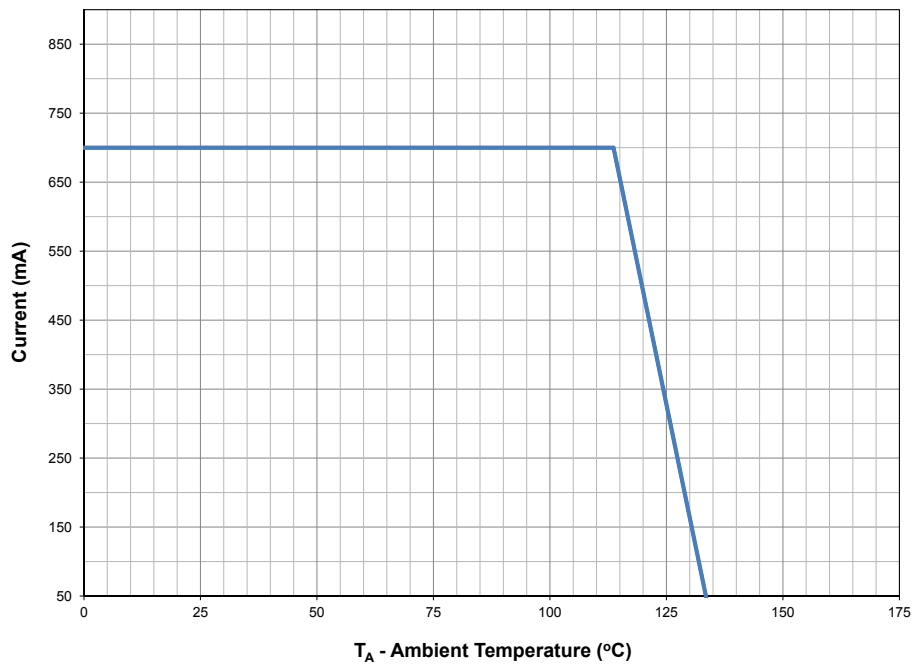

Figure 14. Maximum forward current vs. ambient temperature, based on $T_{JMAX} = 135^{\circ}\text{C}$ for PC Amber.

Typical Radiation Patterns

Typical Representative Spatial Radiation Pattern for Automotive White Lambertian

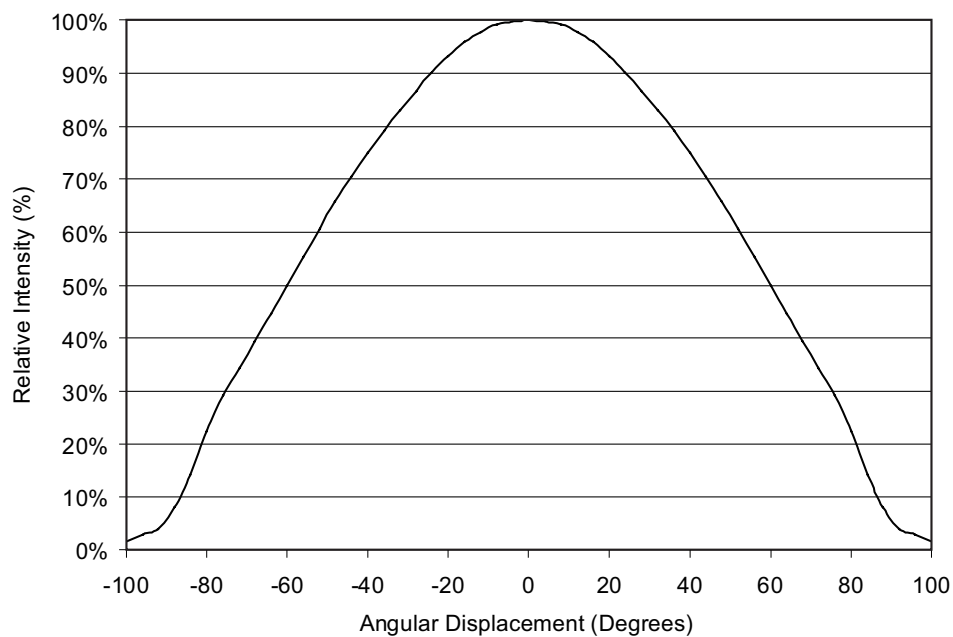

Figure 15. Typical representative spatial radiation pattern for Automotive White lambertian.

Typical Polar Radiation Pattern for Automotive White Lambertian

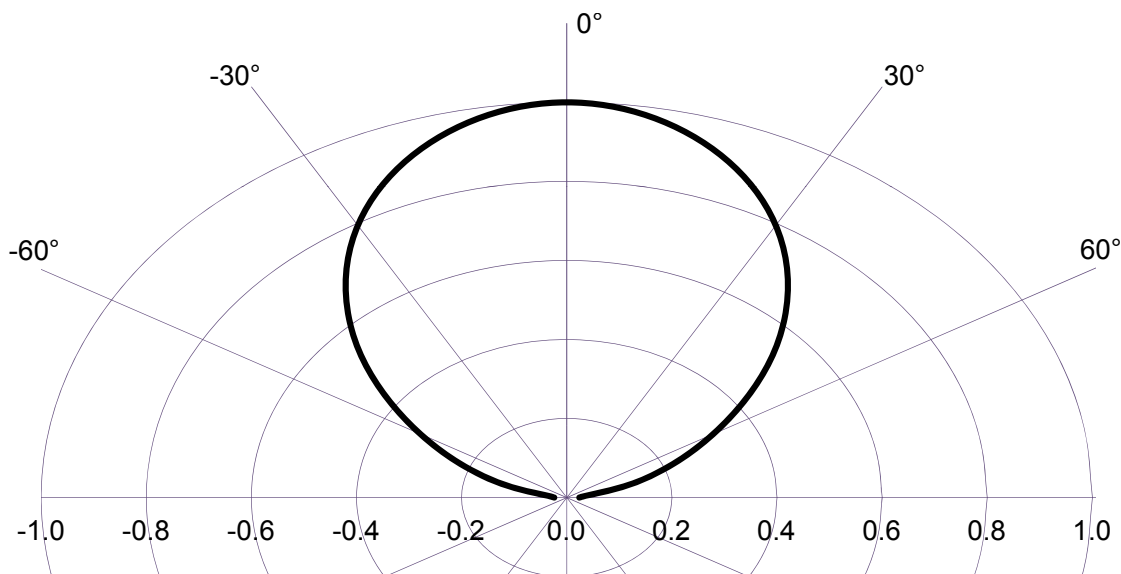

Figure 16. Typical polar radiation pattern for Automotive White lambertian.

Typical Representative Spatial Radiation Pattern for PC Amber Lambertian

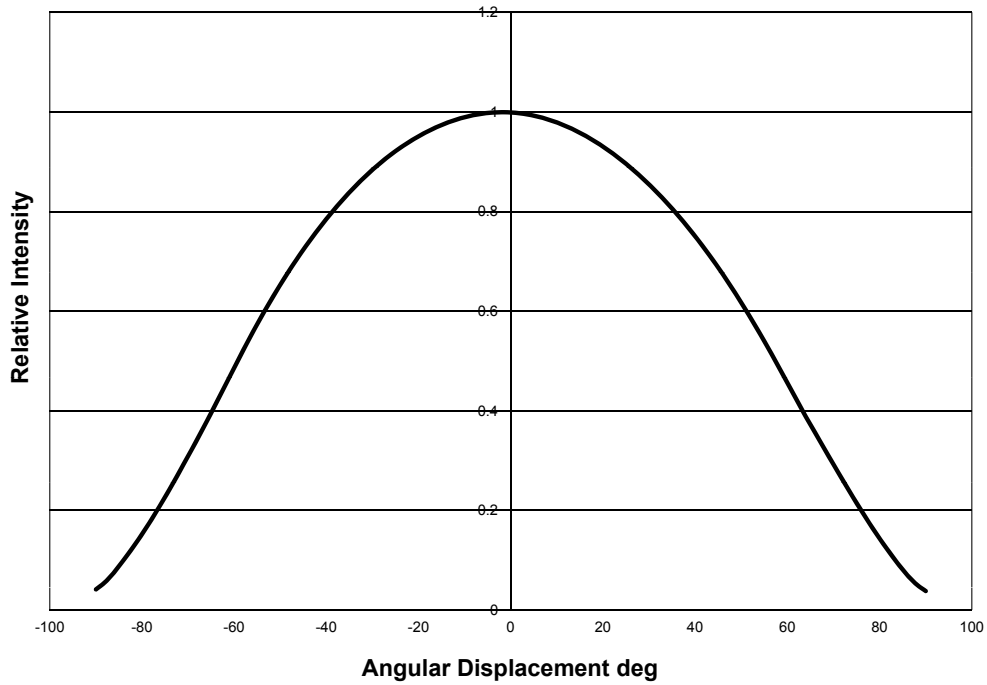

Figure 17. Typical representative spatial radiation pattern for PC Amber lambertian.

Typical Polar Radiation Pattern for PC Amber Lambertian

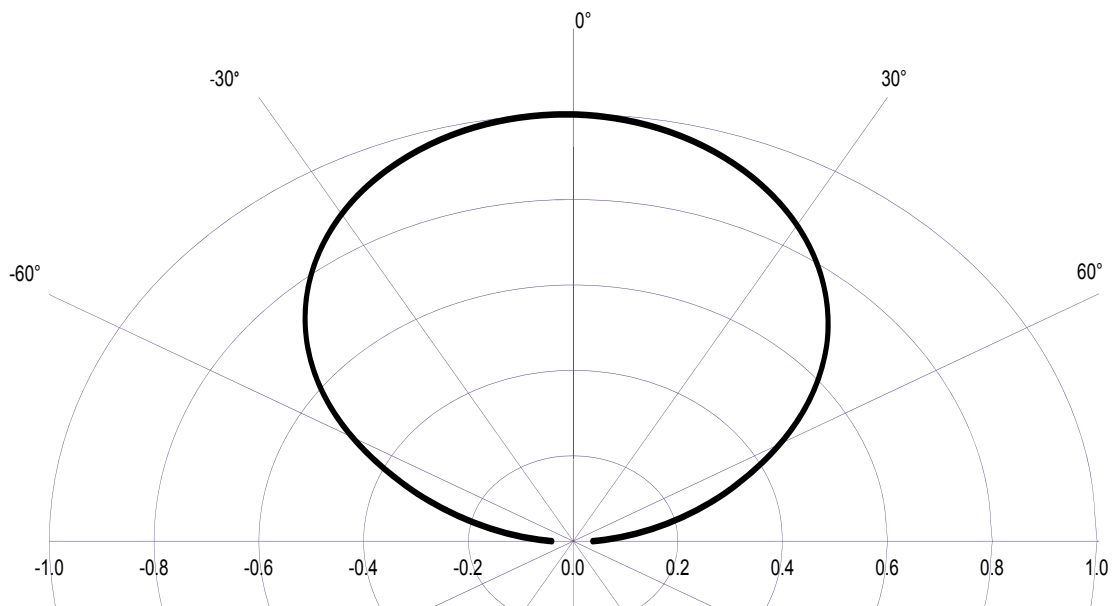

Figure 18. Typical polar radiation pattern for PC Amber lambertian.

Emitter Pocket Tape Packaging

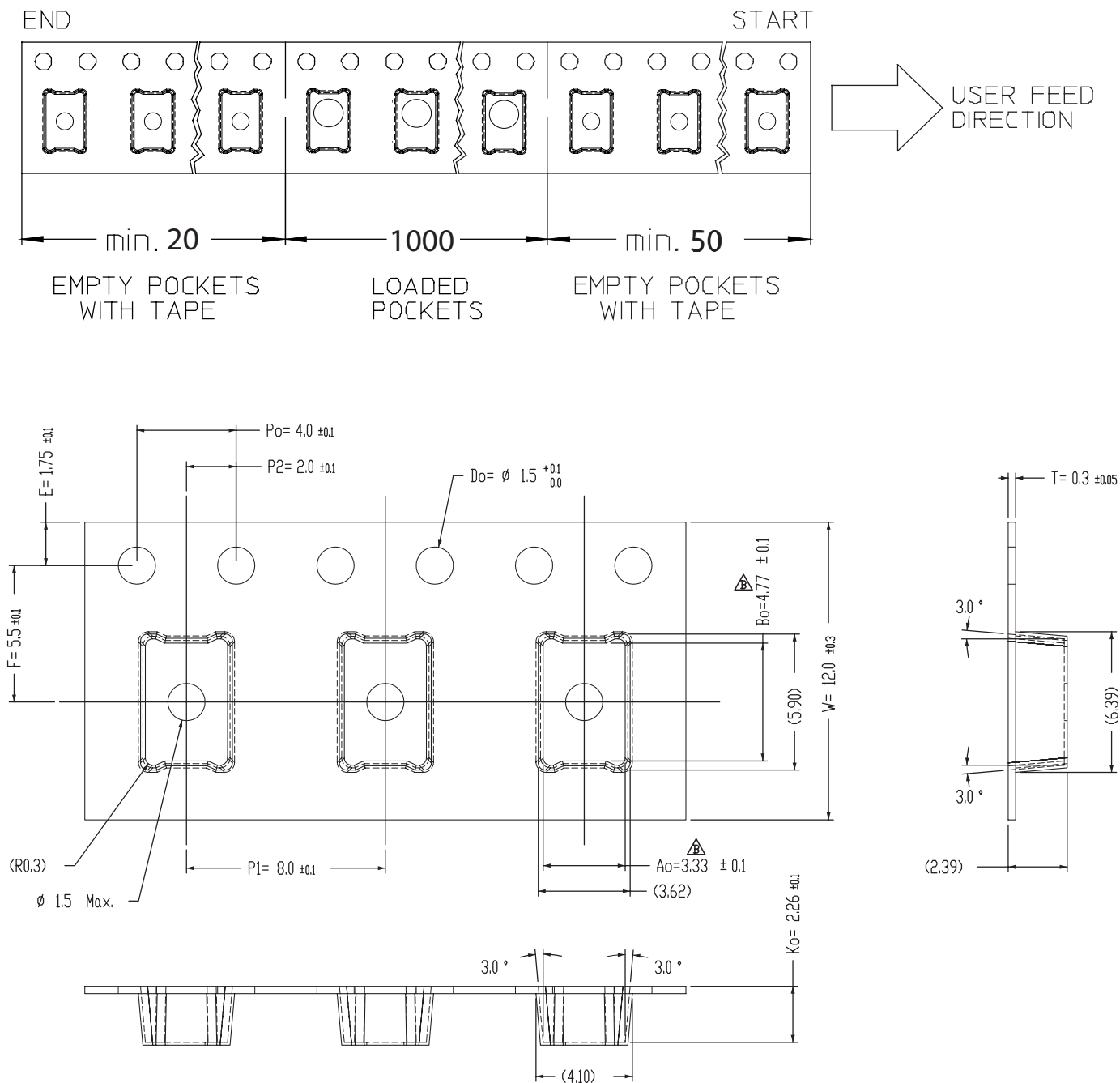

Figure 19. Emitter pocket tape packaging.

Note for Fig 19:
1. SPI 1000.

Emitter Reel Packaging

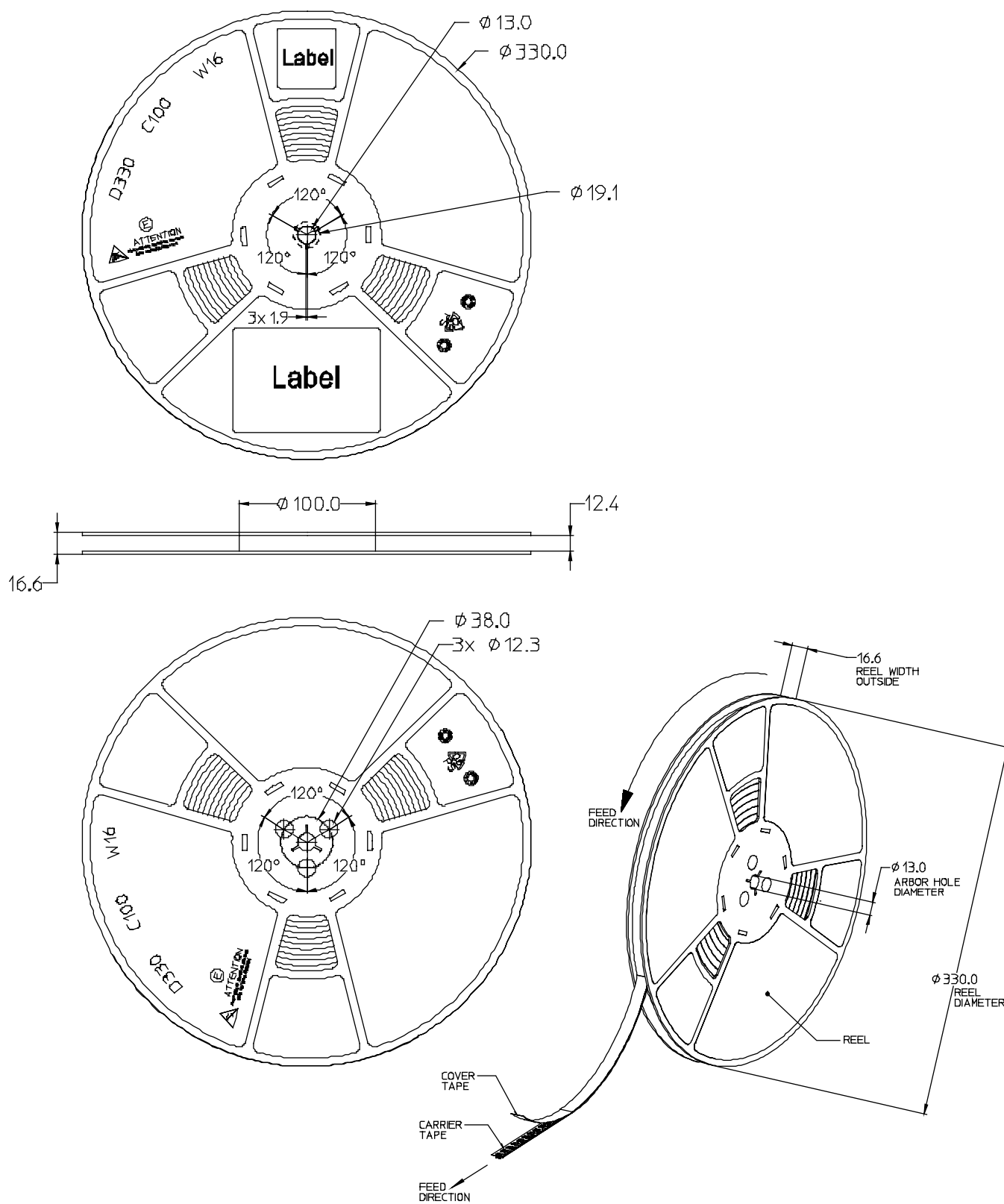

Figure 20. Emitter reel packaging.

Automotive Product Binning and Labeling

Purpose of Product Binning

In the manufacturing of semiconductor products, there is a variation of performance around the average values given in the technical data sheets. For this reason, Lumileds bins the LED components for luminous flux, color and forward voltage (V_f).

Decoding Product Bin Labeling

LUXEON Rebel emitters are labeled using a three or four digit alphanumeric code (CAT code) depicting the bin values for emitters packaged on a single reel. All emitters packaged within a reel are of the same 3-variable bin combination. Using these codes it is possible to determine optimum mixing and matching of products for consistency in a given application.

Format of Labeling for Emitters

Reels of PC Amber emitters are labeled with a three digit alphanumeric CAT code following the format below.

ABC

A = Flux bin (P, Q, R, S, etc.)

B = Color bin (2, 4, etc.)

C = V_f bin (E, F, G, etc.)

Reels of Automotive White emitters are labeled with a four digit alphanumeric CAT code following the format below.

ABCD

A = Flux bin (P, Q, R, S, etc.)

B & C = Color bin (WN, W0, WP, WQ, VN, V0 etc.)

D = V_f bin (E, F, G, etc.)

Luminous Flux Bins

Table 8 lists the standard photometric luminous flux bins for LUXEON Rebel emitters.

Although several bins are outlined, product availability in a particular bin varies by production run and by product performance. Not all bins are available in all colors.

Table 8. Flux Bins - All Colors

Bin Code	Minimum Photometric Flux (lm)	Maximum Photometric Flux (lm)
M	90	100
N	100	110
X	110	120
P	120	130
Y	130	140
Q	140	150
R	150	160

Note for Table 8:

1. Photometric luminous flux bin structure for LUXEON Rebel emitters.

Color Bin Structure

LUXEON Rebel Automotive White Color Bin Structure

LUXEON Rebel emitters for Automotive White applications are tested and binned by x,y coordinates.

Table 9.

Bin Code	X	Y	Typical CCT (K)	Bin Code	X	Y	Typical CCT (K)
WN	0.328816 0.329006 0.316035 0.314789	0.356915 0.345100 0.333218 0.344429	6000	TN	0.381106 0.378264 0.362219 0.364212	0.393747 0.382458 0.371616 0.382878	4300
WO	0.329006 0.329225 0.317472 0.316035	0.345100 0.331336 0.320439 0.333218	6000	TO	0.378264 0.374075 0.359401 0.362219	0.382458 0.365822 0.355699 0.371616	4300
WP	0.329225 0.329389 0.318609 0.317472	0.331336 0.320204 0.310206 0.320439	6000	TP	0.374075 0.370582 0.357079 0.359401	0.365822 0.351953 0.342581 0.355699	4300
VN	0.346991 0.345780 0.329006 0.328816	0.372678 0.359192 0.345100 0.356915	5300	SN	0.396279 0.392368 0.378264 0.381106	0.403508 0.390932 0.382458 0.393747	3950
VO	0.345780 0.344449 0.329225 0.329006	0.359192 0.344234 0.331336 0.345100	5300	SO	0.392368 0.387071 0.374075 0.378264	0.390932 0.373899 0.365822 0.382458	3950

Notes for Table 9:

1. Lumileds maintains a tester tolerance of ± 0.005 on x, y color coordinates.

Graphical Presentation of LUXEON Rebel Automotive White xy Coordinates

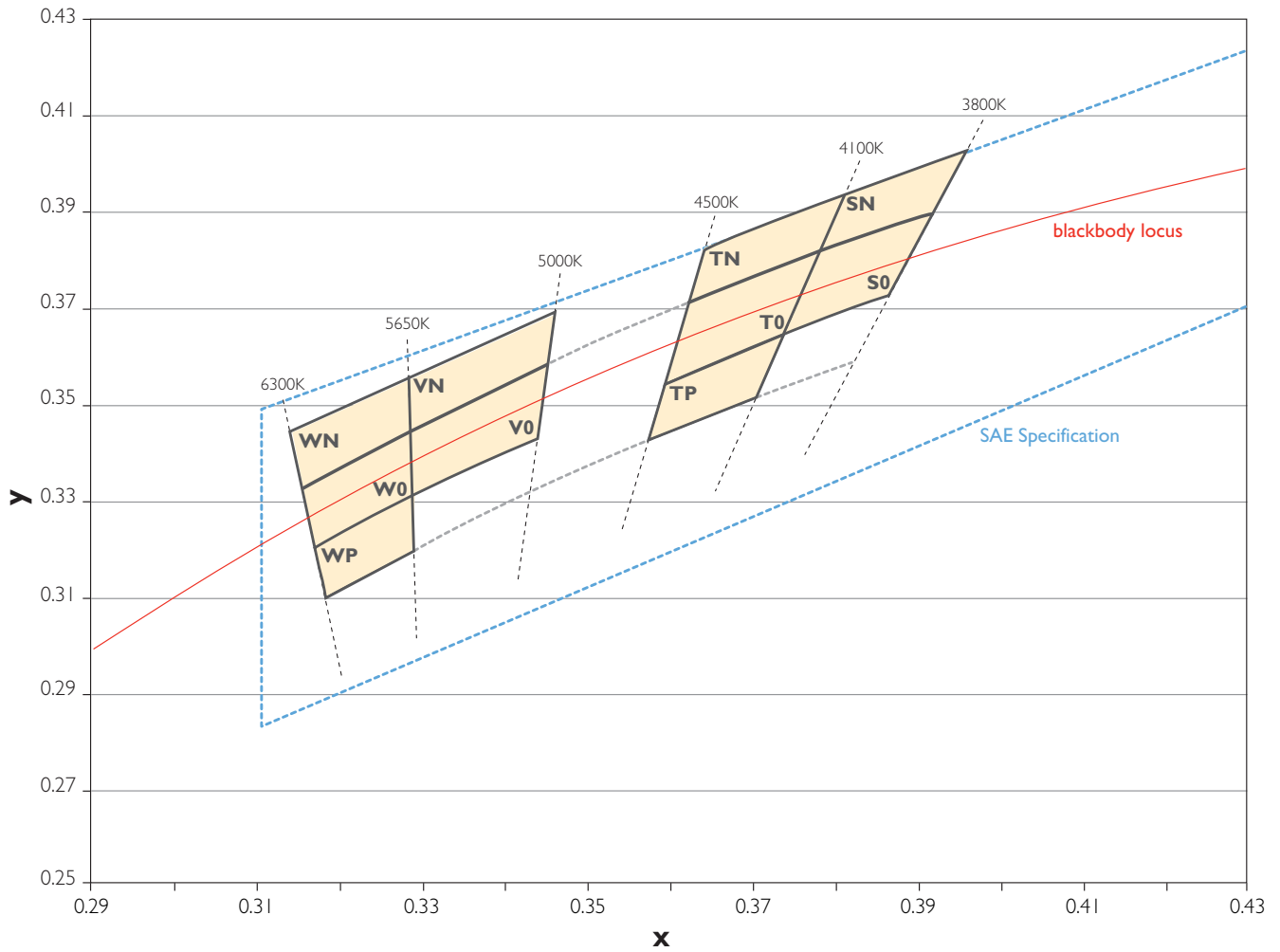

Figure 21. LUXEON Rebel Automotive White color binning structure graphical representation. Coordinates listed in Table 9.

Notes for Figure 21:

1. WN, WO, WP, VN, VO are supportable.
2. TN, TO, TP, SN, SO are not supportable for new programs.

LUXEON Rebel PC Amber Color Bin Structure

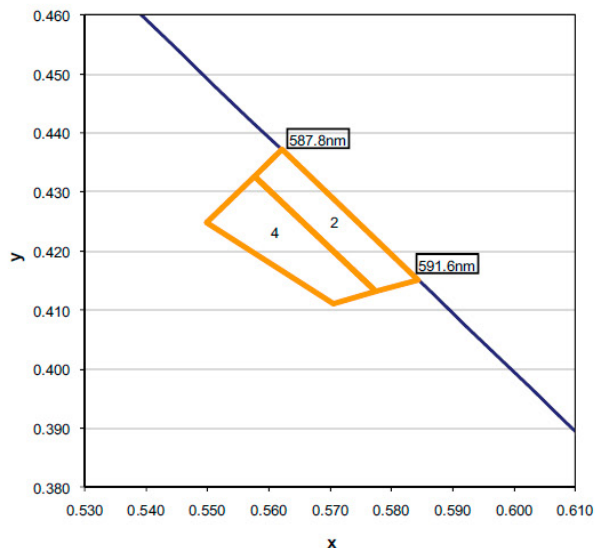

Figure 22. LUXEON Rebel Automotive PC Amber binning structure graphical representation. Coordinates listed in Table 11.

LUXEON Rebel PC Amber Color Bin Coordinates

Table 10.

LUXEON Rebel PC Amber Bin Coordinates		
Color Bin	x	y
2	0.5622	0.4372
	0.5576	0.4326
	0.5775	0.4132
	0.5843	0.4151
4	0.5705	0.4111
	0.5775	0.4132
	0.5576	0.4326
	0.5499	0.4249

Note for Table 10:

1. LUXEON Rebel PC Amber emitters are tested and binned by x, y coordinates.
2. Lumileds maintains a tester tolerance of ± 0.005 on x, y coordinates.
3. Test conditions of 350mA with current pulse duration of 20ms.

Forward Voltage Bins

Table 11 lists minimum and maximum V_f bin values per emitter. Although several bins are outlined, product availability in a particular bin varies by production.

Table 11. Forward Voltage Bin Structure for LUXEON Rebel Automotive White, PC Amber and Amber Emitters

Bin Code	Minimum Forward Voltage (V)	Maximum Forward Voltage (V)
B	2.55	2.79
C	2.79	3.03
D	3.03	3.27

About Lumileds

Lumileds is the light engine leader, delivering innovation, quality, and reliability.

For 100 years, Lumileds commitment to innovation has helped customers pioneer breakthrough products in the automotive, consumer and illumination markets.

Lumileds is shaping the future of light with our LEDs and automotive lamps, and helping our customers illuminate how people see the world around them.

To learn more about our portfolio of light engines visit www.lumileds.com.



©2015 Lumileds Holding B.V. All rights reserved.
LUXEON is a registered trademark of the Lumileds Holding B.V.
in the United States and other countries.

www.lumileds.com

Neither Lumileds Holding B.V. nor its affiliates shall be liable for any kind of loss of data or any other damages, direct, indirect or consequential, resulting from the use of the provided information and data. Although Lumileds Holding B.V. and/or its affiliates have attempted to provide the most accurate information and data, the materials and services information and data are provided "as is," and neither Lumileds Holding B.V. nor its affiliates warrants or guarantees the contents and correctness of the provided information and data. Lumileds Holding B.V. and its affiliates reserve the right to make changes without notice. You as user agree to this disclaimer and user agreement with the download or use of the provided materials, information and data.

Данный компонент на территории Российской Федерации

Вы можете приобрести в компании MosChip.

Для оперативного оформления запроса Вам необходимо перейти по данной ссылке:

<http://moschip.ru/get-element>

Вы можете разместить у нас заказ для любого Вашего проекта, будь то серийное производство или разработка единичного прибора.

В нашем ассортименте представлены ведущие мировые производители активных и пассивных электронных компонентов.

Нашей специализацией является поставка электронной компонентной базы двойного назначения, продукции таких производителей как XILINX, Intel (ex.ALTERA), Vicor, Microchip, Texas Instruments, Analog Devices, Mini-Circuits, Amphenol, Glenair.

Сотрудничество с глобальными дистрибьюторами электронных компонентов, предоставляет возможность заказывать и получать с международных складов практически любой перечень компонентов в оптимальные для Вас сроки.

На всех этапах разработки и производства наши партнеры могут получить квалифицированную поддержку опытных инженеров.

Система менеджмента качества компании отвечает требованиям в соответствии с ГОСТ Р ИСО 9001, ГОСТ РВ 0015-002 и ЭС РД 009

Офис по работе с юридическими лицами:

105318, г.Москва, ул.Щербаковская д.3, офис 1107, 1118, ДЦ «Щербаковский»

Телефон: +7 495 668-12-70 (многоканальный)

Факс: +7 495 668-12-70 (доб.304)

E-mail: info@moschip.ru

Skype отдела продаж:

moschip.ru

moschip.ru_4

moschip.ru_6

moschip.ru_9