

cannon

Trident Series



ITT

ENGINEERED FOR LIFE

We Connect

When it matters most

For more than a century, ITT Cannon has developed innovative interconnect solutions for the world's harshest environments. With facilities in the United States, Germany, Italy, Mexico, China and Japan, each with its unique strengths, we offer our customers interconnect solutions that are truly Engineered for Life.

In addition to this truly global footprint, we offer highly specialized, segmented industry expertise. We have a proven track record as an industry leader in harsh-environment applications. This has equipped us with the knowledge needed to continue to produce the most resilient, reliable connectors for our customers' most challenging conditions.

Interconnect solutions for the harshest environments.

The ITT Cannon difference

- Global capabilities & local support
- Proven application expertise
- A century of interconnect leadership
- A committed innovator & business partner

The logo for Cannon, featuring the word "cannon" in a lowercase, sans-serif font. The letter "o" is replaced by a stylized icon of a gun barrel with a muzzle flash.

About ITT

ITT is a diversified leading manufacturer of highly engineered critical components and customized technology solutions for the energy, transportation and industrial markets. Building on its heritage of innovation, ITT partners with its customers to deliver enduring solutions to the key industries that underpin our modern way of life. Founded in 1920, ITT is headquartered in White Plains, N.Y., with employees in more than 35 countries and sales in a total of approximately 125 countries. For more information, visit www.itt.com.





Industrial / Instrumentation



Defense Vehicles



Medical



Heavy Equipment



Rail



Oil & Gas



Commercial & Military Aerospace

Our connector portfolio remains the most extensive in the industry.

Offering a reliable and cost effective range of interconnect solutions.

Additional interconnect solutions utilizing the trusted and proven Trident contact system



ITT Cannon's Trident T2P and T3P contact technology is an extremely reliable and effective solution for harsh environment interconnects. In addition to the extensive Trident range, this contact technology is used in a number of ITT Cannon and Veam connector series including:



CTC Series

This cost-effective, footprint minimized solution for harsh environment vehicle wiring applications is available in 8 to 24-way layouts. Extremely simple to install and maintain it delivers an IP69K sealing without the need for wedge locks or blind seals.



APD Series

This full-plastic, proven bayonet series with IP69K sealing and color and mechanical coding is an ideal solution for multiple harsh transportation and industrial environments that require high sealing grades.

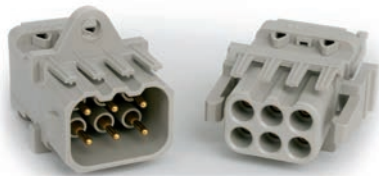

VRPC Series

This full plastic rectangular sealed connector series for multiple transport and industrial applications is extremely durable, small and light weight and meets stringent NFF fire and smoke resistance standards for Rail.

Cannon’s Trident Connector System is a versatile range of electrical connectors based on a standard contact design. These contacts are fully interchangeable throughout the Trident Connector System. The connector options include low cost retangulars, rack and panel, industrial grade circulars, harsh environment circulars and shielded circulars.

Description

Trident Connector System

Connector Selection Guide 6

- Snap Together - Rectangular
 - Introduction 7
 - How to Order 8
 - Contact Cavity Arrangements 9
 - Connectors 10-13
- Flame Retardant - Rectangular
 - Introduction 14
 - Contact Cavity Arrangements 15
 - Connectors 16-17
- Snap Together - Slimline
 - Introduction 18
 - How to Order 19
 - Connectors 19-21
- Ringlock Circular Connectors
 - Introduction 22
 - How to Order 23
 - Contact Cavity Arrangements 24
 - Connectors 25-28
 - Accessories 29-31
- Neptune Circular Connectors
 - Introduction 31
 - How to Order 33
 - Contact Cavity Arrangements 34
 - Connectors 35-42
 - Accessories 43-47
- TNM Circular Connectors
 - Introduction 48
 - How to Order 49
 - Contact Cavity Arrangements 49
 - Connectors 50-53
 - Accessories 54-56
- High Voltage
 - Introduction 57
 - Connectors 58
- Contacts
 - Introduction and Performance Data 59
 - Contact Selection Guide 60-61
 - T2P 62-63
 - T3P 64-67
 - Power 67

Tools 70-71

Assembly Instructions 72-79

Reader’s Resource

- IP Rating Chart 81-82
- Glossary of Terms 83-84
- Part Number Index 85-87
- Product Safety Information 88
- Warranty 88



	Snap Together		Flame Retardant	Circular			
	Rectangular	Slimline	Rectangular	Ringlock	Neptune	Neptune Metal (TNM)	High Voltage (THV)
							
Operating Voltage ¹	Up to 250 V ac rms	Up to 250 V ac rms	Up to 250 V ac rms	Up to 250 V ac rms Up to 380 V ac rms (7 position connector only)	Up to 250 V ac rms	Up to 250 V ac rms	Up to 500 V ac rms
Current Rating ²	Up to 13 A	Up to 10 A	Up to 13 A	Up to 13 A Up to 16 A with High Conductivity Contacts	Up to 13 A Up to 16 A with High Conductivity Contacts Up to 30 A with Power Contacts	Up to 13 A Up to 16 A with High Conductivity Contacts Up to 30 A with Power Contacts Up to 40 A with D Sub Contacts	Up to 34 A with Power Contacts
Operating Temperature	-55°C to +105°C (-67°F to +221°F) (from -40°C, -40°F for PCB versions)	-55°C to +105°C (-67°F to +221°F) (from -40°C, -40°F for PCB versions)	-55°C to +105°C (-67°F to +221°F)	-55°C to +105°C (-67°F to +221°F)	-55°C to +105°C (-67°F to +221°F)	-55°C to +105°C (-67°F to +221°F)	-40°C to +125°C (-40°F to +257°F)
Insulation Resistance	5000 MW at 500 V dc	5000 MW at 500 V dc	5000 MW at 500 V dc	5000 MW at 500 V dc	5000 MW at 500 V dc	5000 MW at 500 V dc	5000 MW at 500 V dc
Durability ³	Up to 500 Mating Cycles	Up to 500 Mating Cycles	Up to 500 Mating Cycles	Up to 500 Mating Cycles	Up to 500 Mating Cycles	Up to 200 Mating Cycles	Up to 200 Mating Cycles
Environmental Sealing	-	-	-	Up to IP65	Up to IP67	Up to IP67	Up to IP67
Flammability	UL 94 V-0	UL 94 V-0	I2/F2 according to NFF 16-101 (fire & smoke standards) UL 94 V-0	UL 94 V-0	UL 94 V-0	UL 94 V-0	UL 94 V-0
Insulator	Black Nylon	Black Nylon	Gray Nylon	Black Nylon	Black Nylon	Black Nylon	Orange Nylon
Coupling Ring	-	-	-	Nickel Plated Brass	Nickel Plated Brass	Nickel Plated Brass	Nickel Plated Brass
Layouts	2, 3, 4, 6, 12, 24, 36	3, 4, 6, 9, 10	2, 3, 4, 6, 12, 24, 36	4, 7, 8, 12, 19, 23, 28, 35, 48	12+0, 19+0 13+2, 20+4, 28+4, 48+0, 19+12 **	4+0, 8+0, 12+0, 3+3, 4+3, 0+4, 19+0 **	4
Page	7-13	18-21	14-17	22-31	32-47	48-56	57-58

* For details please consult the factory

** Signal + Power contacts

1 Depends on contacts used, layout, and degree of pollution

2 Depends on number and type of contacts used

3 Depends on plating and type of contacts used



These are low installed cost connectors rated for up to 13 A and 250 V ac. They are typically used for circuit board and internal wiring applications. Snap Together connectors facilitate easy assembly and removal of equipment such as motors, fans, transformers, etc. All Snap Together - Rectangular connectors are RoHS Compliant.



Applications:

- Vehicle Dashboards.
- Circuit board connections.
- Internal connections.

Product Features

- Easy cost effective installation.
- Integrally molded latches and connector polarization.
- Recognized under the component program of UL Inc.
- Inter-connector discrimination facilities available.
- Accepts formed (stamped) or machined contacts, see page 64.



Performance Specifications

Materials and Finishes

Insulator	Black Nylon, UL 94 V-0
------------------	------------------------

Operating Voltage ¹	Up to 250 V ac rms
Contact Current Rating ²	Up to 13 A
Operating Temperature	-55°C to +105°C (-67°F to +221°F) for free Plug and Receptacles -40°C to +105°C (-40°F to +221°F) for PCB Mounted Receptacles
Insulation Resistance	5000MW min. at 500 V dc
Durability ³	Up to 500 Mating Cycles
Connector Latching Force	150 N min. with latches engaged
Panel Retention Force	500 N min.
Flammability	UL 94 V-0

¹ Depends on contacts used, layout, and degree of pollution

² Depends on number and type of contacts used

³ Depends on plating and type of contacts used

How to Order

Typical Nomenclature:



Type	
PA	Plug; Free
RB	Receptacle; For PCB, with Mounting Lugs
RA	Receptacle; Panel Mounting (delivered without any contacts)
RR	Receptacle, For PCB, 90° Right Angle Mounting (only for 12 position connectors with machined contacts)
AS	Accessory; Receptacle Shroud
AH	Accessory; Plug Strain Relief Hood

Test Specifications

The table below summarizes the results of key tests. Data is applicable to standard connectors with standard contacts. Variations may affect this data, so please consult factory for further information on your requirements.

Test	Method	Criteria of Acceptance
Dielectric Withstanding Voltage	2000 V ac	No breakdown
Thermal Shock	-55°C to +125°C (-67°F to +257°F), 5 cycles	No physical damage
Physical Shock	50 g's peak, 3 axes, 11 millisecond duration half-sine pulse	No physical damage. No loss of continuity >1 sec
Vibration	10 g's peak, 10-500 Hz, 9 hours	No physical damage, No loss of continuity >1 sec
Durability	500 cycles of mating and unmating, 500 mating cycles max	No mechanical or electrical defects
Salt Spray	48 hours	Shall be capable of mating and unmating and meet contact resistance requirements
High Temperature Endurance	1000 hours at 125°C (+257°F)	Insulation Resistance > 100 MΩ
Humidity Steady State	RH 90-95%, 40°C (+104°F), 504 hours	Insulation Resistance > 100 MΩ
Moisture Resistance	10 Cycles	Insulation Resistance > 100 MΩ



Contact Cavity Arrangements – Mating Face View

2-way



3-way



4-way



6-way



12-way



24-way



36-way





Free Plug

- Accepts Pin or Socket contacts.
- Contacts to be ordered separately, see page 64.
- Mates with panel mounted receptacles, see page 11.
- Mates with PCB mounted receptacles, see pages 12-13.
- Connector Discriminating (Keying) Pins available, see page 69.

Number of Contacts	Pack of 100 Part Number	Nomenclature	Dimensions (max.)	
			A	B
2	192990-0350	TST02PA00	15,50 (.610)	17,00 (.669)
3	192923-5920	TST03PA00	19,00 (.748)	17,00 (.669)
4	192990-0370	TST04PA00	24,00 (.944)	17,00 (.669)
6	192923-5930	TST06PA00	19,00 (.748)	22,00 (.866)
12	192923-5940	TST12PA00	19,00 (.748)	32,00 (1.259)
24	192923-5950	TST24PA00	24,00 (.944)	42,00 (1.653)
36	192923-5960	TST36PA00	49,50 (1.948)	32,00 (1.259)



Accessory – Plug Strain Relief Hood

- Provides strain relief and wire protection.
- Secure with a tie-wrap (customer supplies tie-wrap).



Number of Contacts	Pack of 100 Part Number	Nomenclature	Wire Bundle Dia.	Dimensions (max.)			
				A	B	C	D
2	192990-0460	TST02AH00	2,30-8,30 (.090-.326)	46,20 (1.818)	16,10 (.633)	11,00 (.433)	56,50 (2.224)
3	192990-0470	TST03AH00	2,30-8,30 (.090-.326)	46,20 (1.818)	18,60 (.732)	11,00 (.433)	56,50 (2.224)
4	192990-0480	TST04AH00	3,00-10,00 (.118-.393)	46,20 (1.818)	23,70 (.933)	11,00 (.433)	56,50 (2.224)
6	192923-5970	TST06AH00	2,30-8,30 (.090-.326)	46,20 (1.818)	19,00 (.748)	16,40 (.645)	56,50 (2.224)
12	192923-5980	TST12AH00	3,00-10,00 (.118-.393)	45,50 (1.791)	19,00 (.748)	26,40 (1.039)	55,80 (2.196)
24	192923-5990	TST24AH00	4,60-12,70 (.181-.500)	51,00 (2.007)	24,10 (.948)	36,80 (1.448)	60,30 (2.374)
36	192923-6000	TST36AH00	7,00-15,90 (.275-.625)	57,50 (2.263)	49,50 (1.948)	26,40 (1.039)	68,00 (2.677)





Receptacle – Panel Mounted

- Accepts Pin or Socket contacts.
- Contacts to be ordered separately, see page 60.
- Mates with Free Plugs, see page 10.
- Connector Discriminating (Keying) Pins available, see page 69.



Number of Contacts	Pack of 100		Dimensions			
	Part Number	Nomenclature	A	B	C ±0,13 (.005)	D ±0,13 (.005)
2	192990-0360	TST02RA00	19,00 (.748)	14,00 (.551)	11,50 (.452)	11,60 (.456)
3	192923-6010	TST03RA00	24,00 (.944)	14,00 (.551)	16,50 (.649)	11,60 (.456)
4	192990-0380	TST04RA00	29,00 (1.141)	14,00 (.551)	21,70 (.854)	11,60 (.456)
6	192923-6020	TST06RA00	24,00 (.944)	19,00 (.748)	16,50 (.649)	16,70 (.657)
12	192923-6030	TST12RA00	24,00 (.944)	29,00 (1.141)	16,70 (.657)	26,70 (1.051)
24	192923-6040	TST24RA00	29,00 (1.141)	39,00 (1.535)	21,80 (.858)	36,90 (1.452)
36	192923-6050	TST36RA00	54,20 (2.133)	29,00 (1.141)	46,70 (1.838)	26,40 (1.039)



Accessory – Protection Shrouds for Receptacles with Pin Contacts

- Provides protection for panel mounted receptacles with pin contacts.
- Shrouds can be fitted onto panels up to 1,40 (.055) thick.

Number of Contacts	Pack of 100		Dimensions	
	Part Number	Nomenclature	A	B
3	192990-0400	TST03AS00	23,50 (.925)	19,05 (.748)
4	192991-0668	TST04AS00	28,60 (1.126)	19,05 (.748)
6	192990-0420	TST06AS00	23,50 (.925)	24,13 (.948)
12	192990-0430	TST12AS00	23,60 (.929)	34,20 (1.346)
24	192990-0440	TST24AS00	29,70 (1.169)	44,40 (1.748)
36	192990-0450	TST36AS00	54,40 (2.141)	34,00 (1.338)

Dimensions shown in mm (inch)
Specifications and dimensions subject to change

Figure 1



Receptacle –
PCB Mounted
with Pin Contacts

- Mates with Free Plug, see page 10.
- Integrally molded flanges.
- Contacts are on a 5,08 (.200) grid, symmetrical on center lines.
- Recommended PCB hole Ø1,15 (.045).
- Connector Discriminating Caps available, see page 69.

Figure 2



Pack of 100

Number of Contacts	Plating	Formed (Stamped)		Machined		Figure	Dimensions				
		Part Number	Nomenclature	Part Number	Nomenclature		A	B ±0,08 (.003)	C ±0,08 (.003)	D	E
2	Gold*	192900-0411	TST02RB05Y	192991-0270	TST02RB01Z	1	11,13 (.438)	N/A	19,13 (.753)	6,00 (.236)	25,00 (.984)
2	Tin	192990-3230	TST02RB05T	192991-0271	TST02RB01T	1	11,13 (.438)	N/A	19,13 (.753)	6,00 (.236)	25,00 (.984)
3	Gold*	192900-0412	TST03RB05Y	192991-0278	TST03RB01Z	2	16,21 (.638)	14,05 (.553)	10,24 (.403)	6,00 (.236)	20,10 (.791)
3	Tin	192990-3240	TST03RB05T	192991-0279	TST03RB01T	2	16,21 (.638)	14,05 (.553)	10,24 (.403)	6,00 (.236)	20,10 (.791)
4	Gold*	192900-0413	TST04RB05Y	192991-0286	TST04RB01Z	2	21,30 (.838)	14,05 (.553)	15,32 (.603)	6,00 (.236)	20,10 (.791)
4	Tin	192990-3250	TST04RB05T	192991-0287	TST04RB01T	2	21,30 (.838)	14,05 (.553)	15,32 (.603)	6,00 (.236)	20,10 (.791)
6	Gold*	192900-0414	TST06RB05Y	192991-0294	TST06RB01Z	2	16,20 (.637)	19,12 (.752)	10,23 (.402)	11,00 (.433)	26,00 (1.023)
6	Tin	192990-3260	TST06RB05T	192991-0295	TST06RB01T	2	16,20 (.637)	19,12 (.752)	10,23 (.402)	11,00 (.433)	26,00 (1.023)
12	Gold*	192900-0415	TST12RB05Y	192991-0302	TST12RB01Z	2	16,20 (.637)	29,30 (1.153)	10,26 (.404)	21,20 (.834)	35,20 (1.385)
12	Tin	192990-3270	TST12RB05T	192991-0303	TST12RB01T	2	16,20 (.637)	29,30 (1.153)	10,26 (.404)	21,20 (.834)	35,20 (1.385)
24	Gold*	192900-0416	TST24RB05Y	192991-0310	TST24RB01Z	2	21,30 (.838)	39,37 (1.550)	15,32 (.603)	31,30 (1.232)	45,60 (1.795)
24	Tin	192990-3280	TST24RB05T	192991-0311	TST24RB01T	2	21,30 (.838)	39,37 (1.550)	15,32 (.603)	31,30 (1.232)	45,60 (1.795)
36	Gold*	192900-0417	TST36RB05Y	192991-0402	TST36RB01Z	1	46,60 (1.834)	15,24 (.600)	54,64 (2.151)	21,20 (.834)	60,50 (2.382)
36	Tin	192990-3290	TST36RB05T	192991-0403	TST36RB01T	1	46,60 (1.834)	15,24 (.600)	54,64 (2.151)	21,20 (.834)	60,50 (2.382)

* Gold plating for Formed (Stamped) Contacts is 0,75 µm (30 µ in.) min gold. Gold plating for Machined Contacts is gold flash.





Figure 1



Receptacle –
PCB Mounted
with Socket Contacts

- Mates with Free Plug, see page 10.
- Integrally molded flanges.
- Contacts are on a 5,08 (.200) grid, symmetrical on center lines.
- Recommended PCB hole Ø 1,15 (.045).
- Connector Discriminating Pegs available, see page 69.

Figure 2



Pack of 100

Number of Contacts	Formed (Stamped)		Machined		Figure	Dimensions					
	Plating	Part Number	Nomenclature	Part Number		Nomenclature	A	B ±0,08 (.003)	C ±0,08 (.003)	D	E
2	Gold*	192900-0418	TST02RB06Y	192991-0213	TST02RB02Z	1	11,13 (.438)	N/A	19,13 (.753)	6,00 (.236)	25,00 (.984)
2	Tin	192990-3300	TST02RB06T	192991-0214	TST02RB02T	1	11,13 (.438)	N/A	19,13 (.753)	6,00 (.236)	25,00 (.984)
3	Gold*	192900-0419	TST03RB06Y	192991-0221	TST03RB02Z	2	16,21 (.638)	14,05 (.553)	10,24 (.403)	6,00 (.236)	20,10 (.791)
3	Tin	192990-3310	TST03RB06T	192991-0222	TST03RB02T	2	16,21 (.638)	14,05 (.553)	10,24 (.403)	6,00 (.236)	20,10 (.791)
4	Gold*	192900-0420	TST04RB06Y	192991-0229	TST04RB02Z	2	21,30 (.838)	14,05 (.553)	15,32 (.603)	6,00 (.236)	20,10 (.791)
4	Tin	192990-3320	TST04RB06T	192991-0230	TST04RB02T	2	21,30 (.838)	14,05 (.553)	15,32 (.603)	6,00 (.236)	20,10 (.791)
6	Gold*	192900-0421	TST06RB06Y	192991-0237	TST06RB02Z	2	16,20 (.637)	19,12 (.752)	10,23 (.402)	11,00 (.433)	26,00 (1.023)
6	Tin	192990-3330	TST06RB06T	192991-0238	TST06RB02T	2	16,20 (.637)	19,12 (.752)	10,23 (.402)	11,00 (.433)	26,00 (1.023)
12	Gold*	192900-0422	TST12RB06Y	192991-0245	TST12RB02Z	2	16,20 (.637)	29,30 (1.153)	10,26 (.404)	21,20 (.834)	35,20 (1.385)
12	Tin	192990-3340	TST12RB06T	192991-0246	TST12RB02T	2	16,20 (.637)	29,30 (1.153)	10,26 (.404)	21,20 (.834)	35,20 (1.385)
24	Gold*	192900-0423	TST24RB06Y	192991-0253	TST24RB02Z	2	21,30 (.838)	39,37 (1.550)	15,32 (.603)	31,30 (1.232)	45,60 (1.795)
24	Tin	192990-3350	TST24RB06T	192991-0254	TST24RB02T	2	21,30 (.838)	39,37 (1.550)	15,32 (.603)	31,30 (1.232)	45,60 (1.795)
36	Gold*	192900-0424	TST36RB06Y	192991-0261	TST36RB02Z	1	46,60 (1.834)	15,24 (.600)	54,64 (2.151)	21,20 (.834)	60,50 (2.382)
36	Tin	192990-3360	TST36RB06T	192991-0262	TST36RB02T	1	46,60 (1.834)	15,24 (.600)	54,64 (2.151)	21,20 (.834)	60,50 (2.382)

* Gold plating for Formed (Stamped) Contacts is 0,75 µm (30 µ in.) min gold. Gold plating for Machined Contacts is gold flash.

This connector series is compliant to railway standards. The material properties are I2/F2 according to NFF 16-101 & NFF 16-102. These are low installed cost connectors rated for up to 13 A and 250 V ac. They are typically used for circuit board and internal wiring applications. All flame retardant connectors are RoHS Compliant.



Applications:

- Vehicle Dashboards.
- Circuit board connections.
- Internal connections.
- Railway.
- Lighting.
- Cabin Applications.
- Control Consoles.

Product Features

- Material properties I2/F2 according to NFF 16-101 & NFF 16-102
- Easy cost effective installation.
- Integrally molded latches and connector polarization.
- Accepts formed (stamped) or machined contacts, see page 64.



Performance Specifications

Materials and Finishes

Insulator	Gray Nylon
------------------	------------

Operating Voltage ¹	Up to 250 V ac rms
Contact Current Rating ²	Up to 13 A
Operating Temperature	-55°C to +105°C (-67°F to +221°F) for free Plug and Receptacles
Insulation Resistance	5000Mw min. at 500 V dc
Durability ³	Up to 500 Mating Cycles
Connector Latching Force	150 N min. with latches engaged
Panel Retention Force	500 N min.
Flammability	UL 94 V-0

¹ Depends on contacts used, layout, and degree of pollution

² Depends on number and type of contacts used

³ Depends on plating and type of contacts used

Contact Cavity Arrangements – Mating Face View

2-way



3-way



4-way



6-way



12-way



24-way



36-way





Free Plug

- Accepts Pin or Socket contacts.
- Contacts to be ordered separately, see page 60.
- Mates with panel mounted receptacles, see page 17.
- Connector Discriminating (Keying) Pins available, see page 68.

Number of Contacts	Pack of 100		Dimensions (max.)	
	Part Number	Nomenclature	A	B
2	121587-0010	TFR02PA10	15,50 (.610)	17,00 (.669)
3	121587-0011	TFR03PA10	19,00 (.748)	17,00 (.669)
4	121587-0012	TFR04PA10	24,00 (.944)	17,00 (.669)
6	121587-0013	TFR06PA10	19,00 (.748)	22,00 (.866)
12	121587-0014	TFR12PA10	19,00 (.748)	32,00 (1.259)
24	121587-0015	TFR24PA10	24,00 (.944)	42,00 (1.653)
36	121587-0016	TFR36PA10	49,50 (1.948)	32,00 (1.259)



Accessory – Plug Strain Relief Hood

- Provides strain relief and wire protection.
- Secure with a tie-wrap (customer supplies tie-wrap).



Number of Contacts	Pack of 100			Dimensions (max.)			
	Part Number	Nomenclature	Wire Bundle Dia.	A	B	C	D
2	121587-0020	TFR02AH10	2,30-8,30 (.090-.326)	46,20 (1.818)	16,10 (.633)	11,00 (.433)	56,50 (2.224)
3	121587-0021	TFR03AH10	2,30-8,30 (.090-.326)	46,20 (1.818)	18,60 (.732)	11,00 (.433)	56,50 (2.224)
4	121587-0022	TFR04AH10	3,00-10,00 (.118-.393)	46,20 (1.818)	23,70 (.933)	11,00 (.433)	56,50 (2.224)
6	121587-0023	TFR06AH10	2,30-8,30 (.090-.326)	46,20 (1.818)	19,00 (.748)	16,40 (.645)	56,50 (2.224)
12	121587-0024	TFR12AH10	3,00-10,00 (.118-.393)	45,50 (1.791)	19,00 (.748)	26,40 (1.039)	55,80 (2.196)
24	121587-0025	TFR24AH10	4,60-12,70 (.181-.500)	51,00 (2.007)	24,10 (.948)	36,80 (1.448)	60,30 (2.374)
36	121587-0026	TFR36AH10	7,00-15,90 (.275-.625)	57,50 (2.263)	49,50 (1.948)	26,40 (1.039)	68,00 (2.677)



Kit –
Plug and Strain Relief Hood

- Provides protection for panel mounted receptacles with pin contacts.
- Shrouds can be fitted onto panels up to 1,40 (.055) thick.

Number of Contacts	Pack of 100	
	Part Number	Nomenclature
2	121587-0040	TFR02PH10
3	121587-0041	TFR03PH10
4	121587-0042	TFR04PH10
6	121587-0043	TFR06PH10
12	121587-0044	TFR12PH10
24	121587-0045	TFR24PH10
36	121587-0046	TFR36PH10



Receptacle –
Panel Mounted

- Accepts Pin or Socket contacts.
- Contacts to be ordered separately, see page 60.
- Mates with Free Plugs, see page 16.
- Connector Discriminating (Keying) Pins available, see page 68.



Number of Contacts	Pack of 100		Dimensions			
	Part Number	Nomenclature	A	B	C ±0,13 (.005)	D ±0,13 (.005)
2	121587-0030	TFR02RA10	19,00 (.748)	14,00 (.551)	11,50 (.452)	11,60 (.456)
3	121587-0031	TFR03RA10	24,00 (.944)	14,00 (.551)	16,50 (.649)	11,60 (.456)
4	121587-0032	TFR04RA10	29,00 (1.141)	14,00 (.551)	21,70 (.854)	11,60 (.456)
6	121587-0033	TFR06RA10	24,00 (.944)	19,00 (.748)	16,50 (.649)	16,70 (.657)
12	121587-0034	TFR12RA10	24,00 (.944)	29,00 (1.141)	16,70 (.657)	26,70 (1.051)
24	121587-0035	TFR24RA10	29,00 (1.141)	39,00 (1.535)	21,80 (.858)	36,90 (1.452)
36	121587-0036	TFR36RA10	54,20 (2.133)	29,00 (1.141)	46,70 (1.838)	26,40 (1.039)

Dimensions shown in mm (inch)
Specifications and dimensions subject to change

The Slimline offers a low profile connector system that is well suited for circuit board applications. The precision machined contacts are ideal for power and sensitive signals. All Snap Together - Slimline connectors are RoHS Compliant.



Applications:

- Junction Boxes.
- Communications equipment.
- Test equipment.
- Instrumentation.



Product Features

- Less than 10,00 (.393) width on PC board.
- Pin headers pre-loaded with straight or 90° machined solder tail pins.
- Mating plug accepts all Trident signal crimp socket contacts, see page 60.
- Plugs have integrally molded quick connect/disconnect latches.
- Five single row contact arrangements available.
- Recognized under the component program of UL Inc.
- Gold plated version available with earth pin capability.
- 10 A per circuit.

Performance Specifications

Operating Voltage ¹	Up to 250 V ac rms
Contact Current Rating ²	Up to 10 A
Operating Temperature	-55°C to +105°C (-67°F to +221°F) for free Plug & Receptacles -40°C to +105°C (-40°F to +221°F) for PCB Mounted Receptacles
Insulation Resistance	5000MW min. at 500 V dc
Durability ³	Up to 500 Mating Cycles
Connector Latching Force	150 N min. with latches engaged
Panel Retention Force	500 N min.
Flammability	UL 94 V-0

Materials and Finishes

Insulator Black Nylon, UL 94 V-0

¹ Depends on contacts used, layout, and degree of pollution

² Depends on number and type of contacts used

³ Depends on plating and type of contacts used

Test Specifications

The table below summarizes the results of key tests. Data is applicable to standard connectors with standard contacts. Variations may affect this data, so please consult factory for further information on your requirements.

Test	Method	Criteria of Acceptance
Dielectric Withstanding Voltage	2000 V ac	No breakdown
Thermal Shock	-55°C to +125°C (-67°F to +257°F), 5 cycles	No physical damage
Physical Shock	50 g's peak, 3 axes, 11 millisecond duration half-sine pulse	No physical damage. No loss of continuity >1 sec
Vibration	10 g's peak, 10-500 Hz, 9 hours	No physical damage, No loss of continuity >1 sec
Durability 500 cycles of mating and unmating, 500 mating cycles max	No mechanical or electrical defects	
Salt Spray	48 hours and meet contact resistance requirements	Shall be capable of mating and unmating
High Temperature Endurance	1000 hours at 125°C (+257°F)	Insulation Resistance > 100 MΩ
Humidity Steady State	RH 90-95%, 40°C (+125°F), 504 hours	Insulation Resistance > 100 MΩ
Moisture Resistance	10 Cycles	Insulation Resistance > 100 MΩ



Dimensions shown in mm (inch)
Specifications and dimensions subject to change

How to Order

Typical Nomenclature:

TST 03 P F 0 0 *

Series

TST = Trident Snap Together

Number of Contacts

- 03
- 04
- 06
- 09
- 10

Plating Style

- * = None (Plug only)
- T = Tin
- Y = 0,4 mm Gold overall

Contact Type

- 0 = No Contacts (Standard for Plug and Panel Mounted Receptacle)
- 1 = Machined Solder Tail Pin
- 2 = Machined Solder Tail Socket
- 5 = Formed Stamped Solder Tail Pin
- 6 = Formed Stamped Solder Tail Socket

Color of Moulding

- 0 = Black

Variant

RD	PCB Receptacle; Straight Contacts
RE	PCB Receptacle; 90° Contacts
PF	Plug



Plug Connector

- Socket contacts must be ordered separately for the plug connectors, see page 60.

Number of Contacts	Pack of 100			D max.
	Part Number	Nomenclature		
3	192990-0960*	TST03PF00		16,10 (.633)
4	192990-0970	TST04PF00		21,20 (.834)
6	192990-0980	TST06PF00		31,40 (1.236)
9	192990-0990	TST09PF00		46,60 (1.834)
10	192990-1000	TST10PF00		51,60 (2.031)

*Available in gray (material properties I2/F2 according to NFF 16-101 & NFF 16-102), part number: 192990-0965.



Receptacle with Straight Pin Contacts

- For gold plated versions extended earth pins are available in any one or two positions. Contact your local Cannon Sales Office for further details.

Pack of 100

Number of Contacts	Gold Plated Version 0,4 µm (16 µin.) min. Gold		Tin Plated Version		Dimensions (max.)		
	Part Number	Nomenclature	Part Number	Nomenclature	A	B	C
3	192991-0337	TST03RD01Y	192991-0316	TST03RD01T	31,40 (1.236)	19,40 (.763)	25,50 (1.003)
4	192991-0347	TST04RD01Y	192991-0318	TST04RD01T	36,50 (1.437)	14,50 (.964)	30,60 (1.204)
6	192991-0342	TST06RD01Y	192991-0320	TST06RD01T	46,70 (1.838)	34,70 (1.366)	40,70 (1.602)
9	192991-0536	TST09RD01Y	192991-0322	TST09RD01T	61,90 (2.437)	49,90 (1.964)	56,00 (2.204)
10	192991-0354	TST10RD01Y	192991-0324	TST10RD01T	67,00 (2.637)	55,00 (2.165)	61,10 (2.405)

PCB Layout



Number of Contacts	D max.
3	25,50 (1.003)
4	30,60 (1.204)
6	40,70 (1.602)
9	56,00 (2.204)
10	61,10 (2.405)





Receptacle with 90° Pin Contacts

- For gold plated versions extended earth pins are available in any one or two positions. Contact your local Cannon Sales Office for further details.



Pack of 100

Number of Contacts	Gold Plated Version 0,4 μ m (16 μ in.) min. Gold		Tin Plated Version		Dimensions (max.)		
	Part Number	Nomenclature	Part Number	Nomenclature	A	B	C
3	192991-0532*	TST03RE01Y	192991-0317	TST03RE01T	31,40 (1.236)	19,40 (.763)	25,50 (1.003)
4	192991-0533	TST04RE01Y	192991-0319	TST04RE01T	36,50 (1.437)	14,50 (.964)	30,60 (1.204)
6	192991-0534	TST06RE01Y	192991-0321	TST06RE01T	46,70 (1.838)	34,70 (1.366)	40,70 (1.602)
9	192991-0535	TST09RE01Y	192991-0323	TST09RE01T	61,90 (2.437)	49,90 (1.964)	56,00 (2.204)
10	192991-0538	TST10RE01Y	192991-0325	TST10RE01T	67,00 (2.637)	55,00 (2.165)	61,10 (2.405)

*Available in gray (material properties I2/F2 according to NFF 16-101 & NFF 16-102), part number: 192991-0539.

PCB Layout



Number of Contacts	D max.
3	25,50 (1.003)
4	30,60 (1.204)
6	40,70 (1.602)
9	56,00 (2.204)
10	61,10 (2.405)

Ringlock is a range of robust circular connectors for industrial and transportation applications. It uses a metal bayonet coupling system for quick and reliable connections and thermoplastic bodies for low installed cost. The connectors are available in several sizes ranging from 4 to 48 circuits for signals of up to 16 A. With the addition of a cable clamp, the connectors can be water sealed to meet IP65. All Ringlock Circular Connectors are RoHS Compliant.



Applications:

- Industrial Electronics.
- Robotic Systems.
- Manufacturing Equipment.
- Printing Equipment.
- Instrumentation.
- Machine Building.

Product Features

- Rugged metal coupling.
- Available in unsealed and sealed versions.
- Positive bayonet locking.
- Shell to shell keying.
- Integrally molded combined plastic body and insulator.
- Wide range of accessories.
- Accepts all Trident signal contacts.
- PCB versions are available.
- Recognized under the component program of UL Inc.

Performance Specifications

Operating Voltage ¹	Up to 250 V ac rms Up to 380 V ac rms (Size 1807 only)
Contact Current Rating ²	Up to 13 A, Up to 16 A with High Conductivity Contacts
Operating Temperature	-55°C to +105°C (-67°F to + 221°F)
Insulation Resistance	5000MW min. at 500 V dc
Durability ³	Up to 500 Mating Cycles
Environmental Sealing	Up to IP65
Flammability	UL 94 V-0

Materials and Finishes

Connector Body	Black Nylon
Coupling Ring	Nickel Plated Copper Alloy
Bayonet Pins	Stainless Steel
Bayonet Pins Support Band	Nickel Plated Copper Alloy

¹ Depends on contacts used, layout and degree of pollution

² Depends on number and type of contacts used

³ Depends on plating and type of contact used

Test Specifications

The table below summarizes the results of key tests. Data is applicable to standard connectors with standard contacts. Variations may affect this data, so please consult factory for further information on your requirements.

Test	Method	Criteria of Acceptance
Dielectric Withstanding Voltage	1550 V ac for 60 seconds 2500 V ac for 60 seconds (Size 1807 only)	No breakdown No breakdown
Thermal Shock	-55°C to +125°C (-67°F to +257°F), 5 cycles	No physical damage.
Physical Shock	50 g's peak, 3 axes, 11 millisecond duration half-sine pulse	No physical damage. No loss of continuity >1 sec
Vibration	10 g's peak, 10-500 Hz, 9 hours	No physical damage. No loss of continuity >1 sec
Durability 500 cycles of mating and unmating, 500 mating cycles max	No mechanical or Electrical defects	
Salt Spray	48 hours	Shall be capable of mating and unmating and meet contact resistance requirements
High Temperature Endurance	1000 hours at 125°C (+257°F)	Insulation Resistance > 100 MΩ
Humidity Steady State	RH 90-95%, 40°C(+104°F), 504 hours	Insulation Resistance > 100 MΩ
Moisture Resistance	10 Cycles	Insulation Resistance > 100 MΩ

How to Order-Connectors

Typical Nomenclature: TR 16 19 P M S 1 N B



Contact Cavity Arrangements

Mating Face View, Standard Plug

(Mating Face View, Reversed Plug is mirror image)

Shell Size

Number of Contacts



Shell Size 10
4



Shell Size 12
8



Shell Size 14
12



Shell Size 16
19



Shell Size 18
7 (VDE 0110)*



Shell Size 18
23



Shell Size 20
28



Shell Size 22
35



Shell Size 24
48

* Meets creepage and clearance requirements according to VDE 0110.
 Note: The shell size indicates the diameter of the interface in sixteenths of an inch.
 Example: Shell size 16 is 1.00 inch in diameter, 25,4 mm.



Standard Plug
for Pin Contacts

- Mates with Standard Receptacles, see page 26.
- Accepts pin contacts, see page 60.
- Discriminating (Keying) Pins available, see page 68.
- Can be water sealed to IP65.

Shell Size	Number of Contacts	Single Piece Connector		Dimensions					Accessory Thread
		Part Number	Nomenclature	$\varnothing A \pm 0,20 (.008)$	B max.	$\varnothing C \pm 0,15 (.005)$	$\varnothing D \pm 0,15 (.005)$	E	
10	4	192922-1250	TR1004PMS1NB	21,60 (.850)	31,80 (1.252)	10,90 (.429)	12,20 (.480)	19,10 $\pm 0,20 (.751 \pm .007)$	9/16 - 24 UNEF
12	8	192922-1260	TR1208PMS1NB	24,80 (.976)	31,80 (1.252)	13,80 (.543)	15,10 (.594)	19,10 $\pm 0,20 (.751 \pm .007)$	11/16 - 24 UNEF
14	12	192922-1270	TR1412PMS1NB	28,00 (1.102)	31,80 (1.252)	17,00 (.669)	18,30 (.720)	19,10 $\pm 0,20 (.751 \pm .007)$	13/16 - 20 UNEF
16	19	192922-1280	TR1619PMS1NB	31,20 (1.228)	31,80 (1.252)	19,90 (.783)	21,40 (.842)	19,10 $\pm 0,20 (.751 \pm .007)$	15/16 - 20 UNEF
18	7	192990-1330	TR1807PMS1NB	34,30 (1.350)	33,00 (1.299)	22,50 (.885)	24,00 (.944)	19,10 $\pm 0,20 (.751 \pm .007)$	1-1/16 - 18 UNEF
18	23	192990-1320	TR1823PMS1NB	34,30 (1.350)	31,80 (1.252)	22,40 (.881)	24,00 (.944)	19,10 $\pm 0,20 (.751 \pm .007)$	1-1/16 - 18 UNEF
20	28	192922-1290	TR2028PMS1NB	37,50 (1.476)	31,80 (1.252)	25,60 (1.007)	27,10 (1.066)	19,10 $\pm 0,20 (.751 \pm .007)$	1-3/16 - 18 UNEF
22	35	192922-1300	TR2235PMS1NB	40,70 (1.602)	31,80 (1.252)	28,50 (1.122)	30,40 (1.196)	19,10 $\pm 0,20 (.751 \pm .007)$	1-5/16 - 18 UNEF
24	48	192990-1340	TR2448PMS1NB	43,90 (1.728)	31,80 (1.252)	31,70 (1.248)	33,50 (1.318)	14,72 $\pm 0,15 (.580 \pm .006)$	1-7/16 - 18 UNEF

Note: For versions with plastic locking ring, please consult the factory.

IMPORTANT NOTE: Standard and Reversed Format
Equipment design dictates whether the fixed connector is "live" or "dead" when disconnected. Connector housings are available that provide socket contacts on the live side of the equipment.

Standard Format: Receptacle with socket contacts.
Reversed Format: Receptacle with pin contacts.

Standard and Reversed connectors are not interchangeable.



Standard Receptacle for Socket Contacts

ØJ=Flange in Front of Panel
ØH= Flange at Rear of Panel

- Mates with Standard Plugs, see page 25.
- Accepts socket contacts, see page 60.
- Printed circuit contacts are available, see page 60.

Dimensions

Shell Size	Number of Contacts	A max.	B ± 0,15 (.005)	C ± 0,20 (.007)	ØD ± 0,15 (.005)	E ± 0,15 (.005)	F ± 0,25 (.009)	ØG ± 0,10 (.003)	ØH ± 0,10 (.003)	ØJ ± 0,10 (.003)	Accessory Thread
10	4	24,00 (.945)	2,30 (.091)	11,15 (.439)	15,00 (.591)	18,00 (.709)	23,50 (.925)	3,25 (.128)	17,30 (.681)	15,10 (.594)	9/16 - 24 UNEF
12	8	25,80 (1.016)	2,30 (.091)	11,35 (.447)	19,00 (.748)	20,50 (.807)	26,20 (1.031)	3,25 (.128)	21,80 (.858)	18,20 (.716)	11/16 - 24 UNEF
14	12	24,00 (.945)	2,30 (.091)	11,35 (.447)	22,20 (.874)	22,60 (.890)	28,15 (1.108)	3,25 (.128)	25,00 (.984)	21,40 (.842)	13/16 - 20 UNEF
16	19	25,80 (1.016)	2,30 (.091)	11,35 (.447)	25,40 (1.000)	24,20 (.953)	30,50 (1.200)	3,25 (.128)	28,10 (1.106)	24,60 (.968)	15/16 - 20 UNEF
18	7	32,50 (1.280)	2,50 (.098)	18,20 (.716)	28,50 (1.122)	27,00 (1.063)	33,30 (1.311)	3,25 (.128)	31,30 (1.232)	27,80 (1.094)	1-1/16 - 18 UNEF
18	23	25,80 (1.016)	2,50 (.098)	11,35 (.447)	28,50 (1.122)	26,90 (1.059)	33,30 (1.311)	3,25 (.128)	31,30 (1.232)	27,80 (1.094)	1-1/16 - 18 UNEF
20	28	27,00 (1.063)	2,50 (.098)	14,50 (.571)	31,70 (1.248)	29,20 (1.150)	36,50 (1.437)	3,25 (.128)	34,50 (1.358)	30,90 (1.216)	1-3/16 - 18 UNEF
22	35	28,00 (1.102)	3,50 (.138)	14,50 (.571)	34,90 (1.374)	31,60 (1.244)	39,70 (1.563)	3,25 (.128)	37,70 (1.484)	34,10 (1.342)	1-5/16 - 18 UNEF
24	48	30,30 (1.193)	3,50 (.138)	15,30 (.602)	38,05 (1.498)	34,45 (1.356)	42,90 (1.689)	3,90 (.154)	40,90 (1.610)	37,30 (1.468)	1-7/16 - 18 UNEF

Part Numbers-Single Piece Connector

Shell Size	Number of Contacts	Unsealed		Sealed (see important note below)	
		Part Number	Nomenclature	Part Number	Nomenclature
10	4	192922-1190	TR1004RFS1NB	192990-1660	TR1004RFH1NB
12	8	192922-1200	TR1208RFS1NB	192990-1670	TR1208RFH1NB
14	12	192922-1210	TR1412RFS1NB	192990-1680	TR1412RFH1NB
16	19	192922-1220	TR1619RFS1NB	192990-1690	TR1619RFH1NB
18	7	192990-1300	TR1807RFS1NB	192990-1700	TR1807RFH1NB
18	23	192990-1290	TR1823RFS1NB	192990-1710	TR1823RFH1NB
20	28	192922-1230	TR2028RFS1NB	192990-1720	TR2028RFH1NB
22	35	192922-1240	TR2235RFS1NB	192990-1730	TR2235RFH1NB
24	48	192990-1310	TR2448RFS1NB	192990-1740	TR2448RFH1NB

IMPORTANT NOTE: Sealed Connectors

A sealed receptacle has an O-Ring seal that blocks moisture when the plug and receptacle are mated. However, the receptacle is not sealed in an unmated condition. For protection, dust caps are recommended for unmated receptacles, see page 34.

Plug connectors using a sealed cable clamp (see page 35) with jacketed cable will meet IP65 when mated to a sealed receptacle.





Reversed Plug
for Socket Contacts

- Mates with Reversed Receptacles, see page 28.
- Accepts socket contacts, see page 60.
- Discriminating (Keying) Pins available, see page 69.
- Can be water sealed to IP65.

Shell Size	Number of Contacts	Single Piece Connector		Dimensions					Accessory Thread
		Part Number	Nomenclature	$\varnothing A \pm 0,20 (.008)$	B max.	$\varnothing C \pm 0,15 (.005)$	$\varnothing D \pm 0,15 (.005)$	E	
10	4	192926-0500	TR1004PFS1NB	21,60 (.850)	26,10 (1.027)	11,00 (.433)	12,20 (.480)	19,10 $\pm 0,20 (.751 \pm .007)$	9/16 - 24 UNEF
12	8	192926-0510	TR1208PFS1NB	24,80 (.976)	25,60 (1.008)	13,90 (.547)	15,10 (.594)	19,10 $\pm 0,20 (.751 \pm .007)$	11/16 - 24 UNEF
14	12	192926-0520	TR1412PFS1NB	28,00 (1.102)	26,80 (1.055)	17,10 (.673)	18,30 (.720)	19,10 $\pm 0,20 (.751 \pm .007)$	13/16 - 20 UNEF
16	19	192926-0530	TR1619PFS1NB	31,20 (1.228)	27,60 (1.087)	20,00 (.787)	21,40 (.842)	19,10 $\pm 0,20 (.751 \pm .007)$	15/16 - 20 UNEF
18	7	192990-1390	TR1807PFS1NB	34,30 (1.350)	31,50 (1.240)	22,50 (.885)	24,00 (.944)	19,10 $\pm 0,20 (.751 \pm .007)$	1-1/16 - 18 UNEF
18	23	192990-1380	TR1823PFS1NB	34,30 (1.350)	25,60 (1.088)	22,50 (.885)	24,00 (.944)	19,10 $\pm 0,20 (.751 \pm .007)$	1-1/16 - 18 UNEF
20	28	192926-0540	TR2028PFS1NB	37,50 (1.476)	31,30 (1.232)	25,70 (1.011)	27,10 (1.066)	19,10 $\pm 0,20 (.751 \pm .007)$	1-3/16 - 18 UNEF
22	35	192926-0550	TR2235PFS1NB	40,70 (1.602)	31,30 (1.232)	28,60 (1.126)	30,40 (1.196)	19,10 $\pm 0,20 (.751 \pm .007)$	1-5/16 - 18 UNEF
24	48	192990-1400	TR2448PFS1NB	43,90 (1.728)	31,30 (1.232)	31,80 (1.225)	33,50 (1.318)	14,72 $\pm 0,15 (.580 \pm .006)$	1-7/16 - 18 UNEF

Note: For versions with plastic locking ring, please consult the factory.

IMPORTANT NOTE: Standard and Reversed Format

Equipment design dictates whether the fixed connector is "live" or "dead" when disconnected. Connector housings are available that provide socket contacts on the live side of the equipment.

Standard Format: Receptacle with socket contacts.

Reversed Format: Receptacle with pin contacts.

Standard and Reversed connectors are not intermateable.



Reversed Receptacle for Pin Contacts

- Mates with Reversed Plugs, see page 27.
- Accepts pin contacts, see page 60.
- Printed Circuit contacts are available, see page 60.



Panel Cutout



ØJ = Flange in Front of Panel
 ØH = Flange at Rear of Panel

Dimensions

Shell Size	Number of Contacts	A max.	B ±0,15 (.005)	C ±0,20 (.007)	ØD ±0,15 (.005)	E ±0,15 (.005)	F ±0,25 (.009)	ØG ±0,10 (.003)	ØH ±0,10 (.003)	ØJ ±0,10 (.003)	Accessory Thread
10	4	31,50 (1.240)	2,30 (.091)	11,35 (.447)	15,00 (.591)	18,00 (.709)	23,50 (.925)	3,25 (.128)	17,30 (.681)	15,10 (.594)	9/16 - 24 UNEF
12	8	31,50 (1.240)	2,30 (.091)	11,35 (.447)	19,00 (.748)	20,50 (.807)	26,20 (1.031)	3,25 (.128)	21,80 (.858)	18,20 (.716)	11/16 - 24 UNEF
14	12	31,50 (1.240)	2,30 (.091)	11,35 (.447)	22,20 (.874)	22,90 (.902)	28,15 (1.108)	3,25 (.128)	25,00 (.984)	21,40 (.842)	13/16 - 20 UNEF
16	19	31,50 (1.240)	2,30 (.091)	11,35 (.447)	25,40 (1.000)	24,20 (.953)	30,50 (1.200)	3,25 (.128)	28,10 (1.106)	24,60 (.968)	15/16 - 20 UNEF
18	7	34,20 (1.346)	2,30 (.091)	17,80 (.700)	28,50 (1.122)	27,00 (1.063)	33,30 (1.311)	3,25 (.128)	31,30 (1.232)	27,80 (1.094)	1-1/16 - 18 UNEF
18	23	31,50 (1.240)	2,50 (.098)	11,35 (.447)	28,50 (1.122)	26,90 (1.059)	33,30 (1.311)	3,25 (.128)	31,30 (1.232)	27,80 (1.094)	1-1/16 - 18 UNEF
20	28	33,00 (1.299)	2,50 (.098)	14,55 (.573)	31,70 (1.248)	29,20 (1.150)	36,50 (1.437)	3,25 (.128)	34,50 (1.358)	30,90 (1.216)	1-3/16 - 18 UNEF
22	35	33,00 (1.299)	3,50 (.138)	14,55 (.573)	34,90 (1.374)	31,60 (1.244)	39,70 (1.563)	3,25 (.128)	37,70 (1.484)	34,10 (1.342)	1-5/16 - 18 UNEF
24	48	34,80 (1.370)	3,50 (.138)	15,35 (.604)	38,05 (1.498)	34,45 (1.356)	42,90 (1.689)	3,90 (.154)	40,90 (1.610)	37,30 (1.468)	1-7/16 - 18 UNEF

Part Numbers - Single Piece Connector

Shell Size	Number of Contacts	Unsealed		Sealed (see important note below)	
		Part Number	Nomenclature	Part Number	Nomenclature
10	4	192926-0440	TR1004RMS1NB	192990-1760	TR1004RMH1NB
12	8	192926-0450	TR1208RMS1NB	192990-1770	TR1208RMH1NB
14	12	192926-0460	TR1412RMS1NB	192990-1780	TR1412RMH1NB
16	19	192926-0470	TR1619RMS1NB	192990-1790	TR1619RMH1NB
18	7	192990-1360	TR1807RMS1NB	192990-1800	TR1807RMH1NB
18	23	192990-1350	TR1823RMS1NB	192990-1810	TR1823RMH1NB
20	28	192926-0480	TR2028RMS1NB	192990-1820	TR2028RMH1NB
22	35	192926-0490	TR2235RMS1NB	192990-1830	TR2235RMH1NB
24	48	192990-1370	TR2448RMS1NB	192990-1840	TR2448RMH1NB

IMPORTANT NOTE: Sealed Connectors

A sealed receptacle has an O-Ring seal that blocks moisture when the plug and receptacle are mated. However, the receptacle is not sealed in an unmated condition. For protection, dust caps are recommended for unmated receptacles, see page 34.

Plug connectors using a sealed cable clamp (see page 35) with jacketed cable will meet IP65 when mated to a sealed receptacle.



How to Order-Accessories

Typical Nomenclature:

TR 10 A HC 1 N

Series

TR = Trident Ringlock

Shell Size

- 10
- 12
- 14
- 16
- 18
- 20
- 22
- 24

A = Accessory

N = Nylon

Series Identification

1 = Standard

HC = Sealed Cable Clamp

SR = Unsealed Cable Clamp

AD = Heat Shrink Adapter

How to Order-Dust Caps

Typical Nomenclature:

TNA 10 DCR0 - 00 B

Material

Series

TNA = Trident Neptune Accessory
(Ringlock Compatible)

Shell Size

- 10
- 12
- 14
- 16
- 18
- 20
- 22
- 24

Packaging

B = Bulk

L = Single Pack

Accessory Style, Type and Size

Dust Cap		
DC	R0-00	Unsealed Dust Cap, Receptacle (PAD)*



Unsealed
Plastic Dust Caps
for Receptacles

- Protects unmated receptacles.
- Durable construction for long-term use.
- For use with Ringlock receptacles.

Shell Size	Part Number (Each)	Part Number (Pack of 100)	Dimension Ø A max.
10	192900-0666	192900-0676	21,80 (.858)
12	192900-0667	192900-0677	25,40 (1.000)
14	192900-0668	192900-0678	28,60 (1.126)
16	192900-0669	192900-0679	31,70 (1.248)
18	192900-0670	192900-0680	34,90 (1.374)
20	192900-0671	192900-0681	38,10 (1.500)
22	192900-0672	192900-0682	41,20 (1.622)
24	192900-0673	192900-0683	44,40 (1.748)



Adapters for Heat Shrink Boots or Sleeving

Shell Size	Part Number (Each)	Nomenclature	Dimensions			
			ØA ±0,3 (.012)	ØB ±0,3 (.012)	C ±0,3 (.012)	H Thread
10	192990-1430	TR10AAD	21,00 (.827)	18,10 (.712)	19,20 (.755)	9/16 - 24 UNEF-2B
12	192990-1440	TR12AAD	24,00 (.944)	23,40 (.921)	19,20 (.755)	11/16 - 24 UNEF-2B
14	192990-1450	TR14AAD	27,00 (1.063)	24,20 (.952)	19,20 (.755)	13/16 - 20 UNEF-2B
16	192990-1460	TR16AAD	30,20 (1.189)	29,60 (1.165)	21,50 (.846)	15/16 - 20 UNEF-2B
18	192990-1470	TR18AAD	33,30 (1.311)	31,70 (1.248)	21,50 (.846)	1-1/16 - 18 UNEF-2B
20	192990-1480	TR20AAD	36,50 (1.437)	35,80 (1.409)	22,80 (.897)	1-3/16 - 18 UNEF-2B
22	192990-1490	TR22AAD	39,70 (1.563)	38,20 (1.503)	22,80 (.897)	1-5/16 - 18 UNEF-2B
24	192990-1500	TR24AAD	42,90 (1.689)	41,30 (1.626)	21,90 (.862)	1-7/16 - 18 UNEF-2B



Panel Gaskets
for Ringlock Receptacles

- For sealed versions

Shell Size	Part Number (Pack of 100)
10	075-8543-011
12	075-8543-012
14	075-8543-013
16	075-8543-014
18	075-8543-015
20	075-8543-016
22	075-8543-017
24	075-8543-018



**Sealed Cable Clamps
for Use With Ringlock Circular Connectors**

- For use with jacketed cables.
- Provides strain relief and wire protection.
- Can be water sealed to IP65. See notes on pages 26 and 28.
- For assembly instructions, see page 75.

* For disassembly, add 9,00 (.354) for Shell Sizes 10-16 & add 10,60 (.417) for Shell Sizes 18-24.

Shell Size	Part Number (Each)	Nomenclature	Dimensions		
			Ø A max.	B ± 0,20 (.007)	C* max.
10	192990-1530	TR10AHC1N	11,10 (.437)	18,80 (.740)	76,50 (3.011)
12	192990-1540	TR12AHC1N	13,60 (.535)	20,80 (.818)	77,80 (3.063)
14	192990-1550	TR14AHC1N	14,60 (.574)	22,80 (.897)	85,50 (3.366)
16	192990-1560	TR16AHC1N	16,60 (.653)	24,70 (.972)	89,80 (3.535)
18	192990-1570	TR18AHC1N	16,60 (.653)	24,70 (.972)	93,00 (3.661)
20	192990-1580	TR20AHC1N	22,10 (.870)	31,80 (1.252)	107,50 (4.232)
22	192990-1590	TR22AHC1N	22,10 (.870)	31,80 (1.252)	114,50 (4.507)
24	192990-1600	TR24AHC1N	29,60 (1.165)	41,80 (1.645)	128,50 (5.059)

* Assumes a uniformly cylindrical cable. Variations in the diameter could effect sealing.



* For disassembly, add 9,00 (.354) for Shell Sizes 10-16 & add 10,60 (.417) for Shell Sizes 18-24.

**Unsealed Cable Clamps
for Use With Ringlock Circular Connectors**

- Provides strain relief and wire protection.
- For assembly instructions, see page 79.

Shell Size	Part Number (Each)	Nomenclature	Dimensions				
			Ø A max.	B ± 0,15 (.005)	Ø C max.	Ø D ± 0,15 (.005)	E* max.
10	192922-1310	TR10ASR1N	21,50 (.846)	6,40 (.251)	8,70 (.342)	21,00 (.826)	61,30 (2.413)
12	192922-1320	TR12ASR1N	24,90 (.980)	6,40 (.251)	12,80 (.503)	24,00 (.944)	61,30 (2.413)
14	192922-1330	TR14ASR1N	27,00 (1.063)	6,40 (.251)	13,80 (.543)	27,00 (1.063)	67,10 (2.641)
16	192922-1340	TR16ASR1N	30,10 (1.185)	6,40 (.251)	17,00 (.669)	30,20 (1.189)	67,10 (2.641)
18	192990-1510	TR18ASR1N	32,00 (1.259)	7,00 (.275)	19,90 (.783)	33,20 (1.307)	70,80 (2.787)
20	192922-1350	TR20ASR1N	34,30 (1.350)	7,00 (.275)	21,00 (.827)	36,40 (1.433)	79,30 (3.122)
22	192922-1360	TR22ASR1N	37,10 (1.460)	8,20 (.322)	23,00 (.905)	39,60 (1.559)	85,30 (3.358)
24	192990-1520	TR24ASR1N	41,80 (1.645)	8,20 (.322)	27,00 (1.063)	42,80 (1.685)	90,80 (3.574)

Dimensions shown in mm (inch)
Specifications and dimensions subject to change

Neptune is a range of circular connectors specifically designed for harsh environment applications. They come with membrane wire seals that meet the requirements for IP67 and do not require blanking plugs for unused cavities. They will accept various combinations of signal (13 A) and power (30 A) contacts. The receptacle connectors feature stainless steel bayonet pins integrally molded into the bodies. The plug connectors are available with either high strength metal or corrosion resistant plastic coupling rings. All Neptune Circular Connectors are RoHS Compliant.



Applications

- Off Road Vehicles.
- Truck and Bus.
- Agricultural Equipment.
- Construction Equipment.
- Printing Machines.
- Industrial Automation.
- Stamping Machines.

Product Features

- Mixes signal and 30 A power contacts in one housing.
- Printed circuit contacts available.
- Full interface and cable sealing up to IP67.
- Large range of support accessories.
- Robust, cost effective connector for harsh environments.

Performance Specifications

Operating Voltage ¹	Up to 250 V ac rms
Contact Current Rating ²	Up to 13 A, Up to 16 A with High Conductivity Contacts, Up to 30 A with Power Contacts
Operating Temperature	-55°C to + 105°C (-67°F to +221°F)
Insulation Resistance	5000MW min. at 500 V dc
Durability ³	Up to 500 Mating Cycles
Environmental Sealing	Up to IP67
Flammability	UL 94 V-0

¹ Depends on contacts used, layout, and degree of pollution
² Depends on type and number of contacts used
³ Depends on plating and type of contacts used

Materials and Finishes

Connector Body	Black Nylon
Coupling Ring	Nickel Plated Copper Alloy
Bayonet Pins	Stainless Steel
Bayonet Pins Support Band	Nickel Plated Copper Alloy

Test Specifications

The table below summarizes the results of key tests. Data is applicable to standard connectors with standard contacts. Variations may affect this data, so please consult factory for further information on your requirements.

Test	Method	Criteria of Acceptance
Dielectric Withstanding Voltage	2000 V ac for 60 seconds	No breakdown
Thermal Shock	-55°C to +120°C (-67°F to +248°F)	No physical damage
Physical Shock	40 g's peak, 3 axes, 6 millisecond duration half-sine pulse	No physical damage. No loss of continuity >10 sec
Vibration	10 g's peak, 10-500 Hz	No physical damage, No loss of continuity >10 sec
Durability	500 cycles of mating and unmating, 500 mating cycles max	No mechanical or electrical defects
Salt Spray	48 hours	Shall be capable of mating and unmating and meet contact resistance requirements
High Temperature Endurance	1000 hours at 85°C (+185°F) 250 hours at 120°C (+248°F)	Insulation Resistance > 100 MW
Humidity Steady State	RH 90-95%, 40°C (+104°F), 504 hours	Insulation Resistance > 100 MW

How to Order-Connectors

Typical Nomenclature: **TN 7 S 24 - 1219 P 1 B 01**

Series

TN = Trident Neptune

Shell Style

- 0 = Flange Receptacle (4 holes)
- 6 = Plug
- 7 = Jam Nut Receptacle

Sealing Class

- G = Grommet, no nut
- LS = Large Grommet, extender and nut (*Size 24-0048 only*)
- S = With Grommet and nut
- U = Unsealed

Modification

- * = Standard
- 01 = Jam Nut Receptacles bulk packages are delivered without nut
See page 50 for Spare Jam Nuts

Packaging

- B = Bulk (100 pcs)
- L = Single Pack

Connector Finish Materials

- 1 = Standard (Nickel Plated Metal Parts)
- 2 = Plastic Coupling Nut (*TN plug shell sizes 16 and 24 only*)

Contact Type

- P = Pin
- S = Socket

Shell Size		Number of Power Contacts	Number of Signal Contacts
14	-	00	12
16	-	00	19
16	-	02	13
24	-	12	19
24	-	04	20
24	-	04	28
24	-	00	48

Dimensions shown in mm (inch)
Specifications and dimensions subject to change



Contact Cavity Arrangements

Neptune Circular Connectors offer combinations of Signal and Power contacts. The Signal cavities will accept any of the standard Trident contacts, including signal contacts up to 16 A. The power cavities will accept power contacts rated at 30 A. PCB contacts are also available, for more information, see page 60.

Mating Face Views of Reversed and Standard Receptacles.

Shell Size

Number of Power Contacts

Number of Signal Contacts



Shell Size 14
0 Power
12 Signal



Shell Size 16
0 Power
19 Signal



Shell Size 16
2 Power
13 Signal

The view is of reversed receptacle
Standard receptacle is a mirror image



Shell Size 24
12 Power
19 Signal



Shell Size 24
4 Power
20 Signal



Shell Size 24
4 Power
28 Signal



Shell Size 24
0 Power
48 Signal

Note: The Signal cavities will accept any of the standard Trident contacts, including signal contacts up to 16 A. The power cavities will accept power contacts rated at 30 A. PCB contacts are also available.

Wire Sealing Range*

Contact Arrangement (Power- Signal Contacts)	Signal (Overall Diameter)	Power (Overall Diameter)
0-12	1,70-2,70 (.066-.106)	N/A
0-19	1,70-2,70 (.066-.106)	N/A
2-13	1,70-2,70 (.066-.106)	2,70-4,00 (.106-.157)
4-20	1,70-2,70 (.066-.106)	2,70-4,00 (.106-.157)
4-28	1,70-2,70 (.066-.106)	2,70-4,00 (.106-.157)
0-48	1,70-2,20 (.066-.086)	N/A
0-48 (L)	2,60-3,20 (.102-.126)	N/A
12-19	1,70-2,70 (.066-.106)	2,70-4,00 (.106-.157)

(L) Larger overall sealing diameter for thick insulation wires
* Describes the range of cable diameters to be used respective layout





**Standard Plug
for Pin Contacts
Metal Locking Ring**

- For Wire Sealing Ranges, see page 34.
- Accepts pin contacts, see page 60.
- Water sealed to IP67.

With Wire Seal and Securing Nut

Shell Size	Contact Layout		Single Piece Connector		Bulk Packages (100 Connectors)		A	ØB	ØC	D
	Power Contacts	Signal Contacts	Part Number	Nomenclature	Part Number	Nomenclature				
14	00	12	192900-0303	TN6S14-0012P1L	192900-0318	TN6S14-0012P1B	38,80 (1.527)	24,30 (.957)	28,00 (1.102)	19,10 ±0,20 (.751 ±.007)
16	00	19	192900-0017	TN6S16-0019P1L	192900-0013	TN6S16-0019P1B	38,90 (1.532)	27,00 (1.063)	30,20 (1.189)	19,10 ±0,20 (.751 ±.007)
16	02	13	192900-0507	TN6S16-0213P1L	192900-0510	TN6S16-0213P1B	38,90 (1.532)	27,00 (1.063)	30,20 (1.189)	19,10 ±0,20 (.751 ±.007)
24	00	48	192900-0469	TN6S24-0048P1L	192900-0472	TN6S24-0048P1B	39,80 (1.566)	40,50 (1.594)	44,00 (1.732)	14,72 ±0,15 (.580 ±.006)
24	04	20	192900-0014	TN6S24-0420P1L	192990-9430	TN6S24-0420P1B	39,80 (1.566)	40,50 (1.594)	44,00 (1.732)	14,72 ±0,15 (.580 ±.006)
24	04	28	192900-0015	TN6S24-0428P1L	192900-0012	TN6S24-0428P1B	39,80 (1.566)	40,50 (1.594)	44,00 (1.732)	14,72 ±0,15 (.580 ±.006)
24	12	19	192900-0016	TN6S24-1219P1L	192990-9380	TN6S24-1219P1B	39,80 (1.566)	40,50 (1.594)	44,00 (1.732)	14,72 ±0,15 (.580 ±.006)
24	00	48 (L)	192991-0628	TN6LS24-0048P1L	192991-0637	TN6LS24-0048P1B	50,70 (2.000)	40,50 (1.594)	44,00 (1.732)	14,72 ±0,15 (.580 ±.006)

Without Securing Nut

Shell Size	Contact Layout		Single Piece Connector		Bulk Packages (100 Connectors)		A	ØB	ØC	D
	Power Contacts	Signal Contacts	Part Number	Nomenclature	Part Number	Nomenclature				
14	00	12	*	TN6G14-0012P1L	192900-0319	TN6G14-0012P1B	-	13/16 – 20 UNEF	28,00 (1.102)	19,10 ±0,20 (.751 ±.007)
16	00	19	*	TN6G16-0019P1L	192900-0095	TN6G16-0019P1B	-	15/16 – 20 UNEF	30,20 (1.189)	19,10 ±0,20 (.751 ±.007)
24	00	48	*	TN6G24-0048P1L	192900-0473	TN6G24-0048P1B	-	1-7/16 – 18 UNEF	44,00 (1.732)	14,72 ±0,15 (.580 ±.006)
24	04	20	*	TN6G24-0420P1L	192900-0092	TN6G24-0420P1B	-	1-7/16 – 18 UNEF	44,00 (1.732)	14,72 ±0,15 (.580 ±.006)
24	04	28	*	TN6G24-0428P1L	192990-0093	TN6G24-0428P1B	-	1-7/16 – 18 UNEF	44,00 (1.732)	14,72 ±0,15 (.580 ±.006)
24	12	19	*	TN6G24-1219P1L	192900-0094	TN6G24-1219P1B	-	1-7/16 – 18 UNEF	44,00 (1.732)	14,72 ±0,15 (.580 ±.006)

Unsealed - Without Wire Seal and Securing Nut

Shell Size	Contact Layout		Single Piece Connector		Bulk Packages (100 Connectors)		A	ØB	ØC	D
	Power Contacts	Signal Contacts	Part Number	Nomenclature	Part Number	Nomenclature				
16	02	13	*	TN6U16-0213P1L	*	TN6U16-0213P1B	34,70 (1.366)	15/16 – 20 UNEF	30,20 (1.189)	19,10 ±0,20 (.751 ±.007)
24	04	20	*	TN6U24-0420P1L	*	TN6U24-0420P1B	35,70 (1.406)	1-7/16 – 18 UNEF	44,00 (1.732)	14,72 ±0,15 (.580 ±.006)
24	04	28	*	TN6U24-0428P1L	*	TN6U24-0428P1B	35,70 (1.406)	1-7/16 – 18 UNEF	44,00 (1.732)	14,72 ±0,15 (.580 ±.006)
24	12	19	*	TN6U24-1219P1L	*	TN6U24-1219P1B	35,70 (1.406)	1-7/16 – 18 UNEF	44,00 (1.732)	14,72 ±0,15 (.580 ±.006)

* For details please consult the factory



Standard Plug
for Pin Contacts
Plastic Locking Ring

- For Wire Sealing Ranges, see page 34.
- Accepts pin contacts, see page 60.
- Water sealed to IP67.

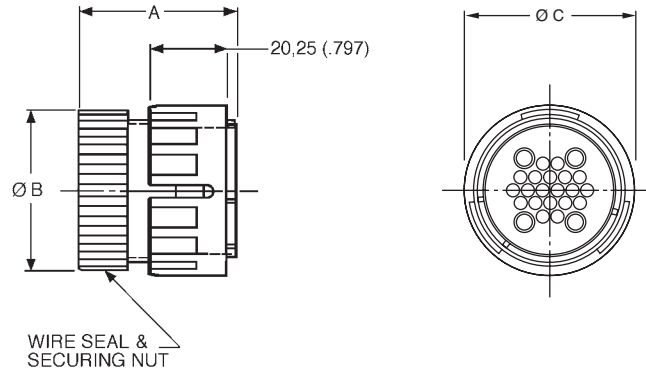

With Wire Seal and Securing Nut

Shell Size	Contact Layout		Single Piece Connector		Bulk Packages (100 Connectors)		A	ØB	ØC
	Power Contacts	Signal Contacts	Part Number	Nomenclature	Part Number	Nomenclature			
16	00	19	192900-0557	TN6S16-0019P2L	*	TN6S16-0019P2B	38,90 (1.532)	27,00 (1.063)	32,80 (1.291)
16	02	13	192900-0561	TN6S16-0213P2L	*	TN6S16-0213P2B	38,90 (1.532)	27,00 (1.063)	32,80 (1.291)
24	00	48	192900-0539	TN6S24-0048P2L	*	TN6S24-0048P2B	39,80 (1.566)	40,50 (1.594)	45,75 (1.800)
24	04	20	192900-0537	TN6S24-0420P2L	*	TN6S24-0420P2B	39,80 (1.566)	40,50 (1.594)	45,75 (1.800)
24	04	28	192900-0549	TN6S24-0428P2L	192900-0551	TN6S24-0428P2B	39,80 (1.566)	40,50 (1.594)	45,75 (1.800)
24	12	19	192900-0538	TN6S24-1219P2L	*	TN6S24-1219P2B	39,80 (1.566)	40,50 (1.594)	45,75 (1.800)
24	00	48 (L)	192991-0660	TN6LS24-0048P2L	*	TN6LS24-0048P2B	50,70 (2.000)	40,50 (1.594)	45,75 (1.800)

Unsealed - Without Wire Seal and Securing Nut

Shell Size	Contact Layout		Single Piece Connector		Bulk Packages (100 Connectors)		A	ØB	ØC
	Power Contacts	Signal Contacts	Part Number	Nomenclature	Part Number	Nomenclature			
16	02	13	*	TN6U16-0213P2L	*	TN6U16-0213P2B	34,70 (1.366)	15/16 – 20 UNEF	32,80 (1.291)
24	04	20	*	TN6U24-0420P2L	*	TN6U24-0420P2B	35,70 (1.406)	1-7/16 – 18 UNEF	45,75 (1.800)
24	04	28	*	TN6U24-0428P2L	192900-0692	TN6U24-0428P2B	35,70 (1.406)	1-7/16 – 18 UNEF	45,75 (1.800)
24	12	19	*	TN6U24-1219P2L	192900-0691	TN6U24-1219P2B	35,70 (1.406)	1-7/16 – 18 UNEF	45,75 (1.800)

* For details please consult the factory



Standard Receptacle for Socket Contacts
Flange Mounting

- For Wire Sealing Ranges, see page 34.
- 3,00 (.118) max with Panel Gasket.
- For Panel Gaskets, see page 47.



With Wire Seal and Securing Nut

Shell Size	Contact Layout		Single Piece Connector		Bulk Packages (100 Connectors)		A	B	C	ØD	ØE	F	G	ØH	ØJ	ØK
	Power Contacts	Signal Contacts	Part Number	Nomenclature	Part Number	Nomenclature										
14	00	12	192900-0308	TN0S14-0012S1L	192900-0323	TN0S14-0012S1B	39,70 (1.563)	3,50 (.137)	11,40 (.448)	22,20 (.874)	24,30 (.956)	28,60 (1.122)	22,90 (.901)	3,20 (.125)	24,60 (.968)	24,60 (.968)
16	00	19	192900-0039	TN0S16-0019S1L	192900-0029	TN0S16-0019S1B	39,80 (1.566)	2,30 (.090)	11,40 (.448)	25,40 (1.000)	27,00 (1.063)	31,00 (1.220)	24,50 (.964)	3,20 (.125)	28,10 (1.106)	28,10 (1.106)
16	02	13	192900-0509	TN0S16-0213S1L	192900-0512	TN0S16-0213S1B	39,80 (1.566)	2,30 (.090)	11,40 (.448)	25,40 (1.000)	27,00 (1.063)	31,00 (1.220)	24,50 (.964)	3,20 (.125)	28,10 (1.106)	28,10 (1.106)
24	00	48	192900-0475	TN0S24-0048S1L	192900-0478	TN0S24-0048S1B	41,80 (1.645)	3,50 (.137)	15,40 (.606)	38,10 (1.500)	40,10 (1.578)	50,80 (2.000)	39,70 (1.563)	4,20 (.165)	41,00 (1.614)	41,00 (1.614)
24	04	20	192900-0030	TN0S24-0420S1L	192990-9420	TN0S24-0420S1B	41,80 (1.645)	3,50 (.137)	15,40 (.606)	38,10 (1.500)	40,10 (1.578)	50,80 (2.000)	39,70 (1.563)	4,20 (.165)	41,00 (1.614)	41,00 (1.614)
24	04	28	192900-0033	TN0S24-0428S1L	192900-0024	TN0S24-0428S1B	41,80 (1.645)	3,50 (.137)	15,40 (.606)	38,10 (1.500)	40,10 (1.578)	50,80 (2.000)	39,70 (1.563)	4,20 (.165)	41,00 (1.614)	41,00 (1.614)
24	12	19	192900-0036	TN0S24-1219S1L	192990-9390	TN0S24-1219S1B	41,80 (1.645)	3,50 (.137)	15,40 (.606)	38,10 (1.500)	40,10 (1.578)	50,80 (2.000)	39,70 (1.563)	4,20 (.165)	41,00 (1.614)	41,00 (1.614)
24	00	48 (L)	192991-0640	TN0LS24-0048S1L	*	TN0LS24-0048S1B	52,70 (2.075)	3,50 (.137)	15,40 (.606)	38,10 (1.500)	40,10 (1.578)	50,80 (2.000)	39,70 (1.563)	4,20 (.165)	41,00 (1.614)	41,00 (1.614)

Without Securing Nut

Shell Size	Contact Layout		Single Piece Connector		Bulk Packages (100 Connectors)		A	B	C	ØD	ØE	F	G	ØH	ØJ	ØK
	Power Contacts	Signal Contacts	Part Number	Nomenclature	Part Number	Nomenclature										
14	00	12	*	TN0G14-0012S1L	192900-0324	TN0G14-0012S1B	-	2,30 (.090)	11,40 (.448)	22,20 (.874)	13/16 – 20 UNEF	28,60 (1.122)	22,90 (.901)	3,20 (.125)	24,60 (.968)	24,60 (.968)
16	00	19	*	TN0G16-0019S1L	192900-0105	TN0G16-0019S1B	-	2,30 (.090)	11,40 (.448)	25,40 (1.000)	15/16 – 20 UNEF	31,00 (1.220)	24,50 (.964)	3,20 (.125)	28,10 (1.106)	28,10 (1.106)
24	00	48	192900-0479	TN0G24-0048S1L	*	TN0G24-0048S1B	-	3,50 (.137)	15,40 (.606)	38,18 (1.500)	1-7/16 – 18 UNEF	50,80 (2.000)	39,70 (1.563)	4,20 (.165)	41,00 (1.614)	41,00 (1.614)
24	04	20	*	TN0G24-0420S1L	192900-0096	TN0G24-0420S1B	-	3,50 (.137)	15,40 (.606)	38,18 (1.500)	1-7/16 – 18 UNEF	50,80 (2.000)	39,70 (1.563)	4,20 (.165)	41,00 (1.614)	41,00 (1.614)
24	04	28	*	TN0G24-0428S1L	192900-0099	TN0G24-0428S1B	-	3,50 (.137)	15,40 (.606)	38,18 (1.500)	1-7/16 – 18 UNEF	50,80 (2.000)	39,70 (1.563)	4,20 (.165)	41,00 (1.614)	41,00 (1.614)
24	12	19	*	TN0G24-1219S1L	192900-0102	TN0G24-1219S1B	-	3,50 (.137)	15,40 (.606)	38,18 (1.500)	1-7/16 – 18 UNEF	50,80 (2.000)	39,70 (1.563)	4,20 (.165)	41,00 (1.614)	41,00 (1.614)

* For details please consult the factory

Dimensions shown in mm (inch)
Specifications and dimensions subject to change



Standard Receptacle for Socket Contacts
Jam Nut Mounting

With Wire Seal and Securing Nut

- Bulk packages are not supplied with Jam Nuts, to order Jam Nuts, see page 46.
- For Wire Sealing Ranges, see page 34.
- Panel thickness 4,00 (.157) max.
- 3,00 (.118) max with Panel gasket.
- For Panel Gaskets, see page 47.

Shell Size	Contact Layout		Single Piece Connector		Bulk Packages (100 Connectors)		A	B	C	ØD	ØE	ØF	G	H	ØJ
	Power	Signal	Part Number	Nomenclature	Part Number	Nomenclature									
14	00	12	192900-0313	TN7S14-0012S1L	192900-0328	TN7S14-0012S1B01	39,70 (1.563)	3,50 (.137)	22,10 (.870)	22,20 (.874)	24,30 (.956)	35,80 (1.409)	32,20 (1.267)	25,10 (.988)	27,30 (1.075)
16	00	19	192900-0490	TN7S16-0019S1L	192900-0493	TN7S16-0019S1B01	39,80 (1.566)	2,30 (.090)	23,00 (.905)	25,40 (1.000)	27,00 (1.063)	39,80 (1.566)	38,40 (1.511)	28,00 (1.102)	30,50 (1.200)
16	02	13	192900-0508	TN7S16-0213S1L	192900-0511	TN7S16-0213S1B01	39,80 (1.566)	2,30 (.090)	23,00 (.905)	25,40 (1.000)	27,00 (1.063)	39,80 (1.566)	38,40 (1.511)	28,00 (1.102)	30,50 (1.200)
24	00	48	192900-0481	TN7S24-0048S1L	192900-0484	TN7S24-0048S1B01	41,80 (1.645)	3,50 (.137)	23,40 (.921)	38,10 (1.500)	40,10 (1.578)	51,00 (2.007)	47,50 (1.870)	41,50 (1.633)	43,20 (1.700)
24	04	20	192900-0032	TN7S24-0420S1L	192990-9460	TN7S24-0420S1B01	41,80 (1.645)	3,50 (.137)	23,40 (.921)	38,10 (1.500)	40,10 (1.578)	51,00 (2.007)	47,50 (1.870)	41,50 (1.633)	43,20 (1.700)
24	04	28	192900-0035	TN7S24-0428S1L	192900-0026	TN7S24-0428S1B01	41,80 (1.645)	3,50 (.137)	23,40 (.921)	38,10 (1.500)	40,10 (1.578)	51,00 (2.007)	47,50 (1.870)	41,50 (1.633)	43,20 (1.700)
24	12	19	192900-0038	TN7S24-1219S1L	192900-0028	TN7S24-1219S1B01	41,80 (1.645)	3,50 (.137)	23,40 (.921)	38,10 (1.500)	40,10 (1.578)	51,00 (2.007)	47,50 (1.870)	41,50 (1.633)	43,20 (1.700)
24	00	48 (L)	192991-0644	TN7LS24-0048S1L	*	TN7LS24-0048S1B01	52,70 (2.075)	3,50 (.137)	23,40 (.921)	38,10 (1.500)	40,10 (1.578)	51,00 (2.007)	47,50 (1.870)	41,50 (1.633)	43,20 (1.700)

Without Securing Nut

Shell Size	Contact Layout		Single Piece Connector		Bulk Packages (100 Connectors)		A	B	C	ØD	ØE	ØF	G	H	ØJ
	Power	Signal	Part Number	Nomenclature	Part Number	Nomenclature									
14	00	12	*	TN7G14-0012S1L	192900-0329	TN7G14-0012S1B01	-	2,30 (.090)	22,10 (.870)	22,20 (.874)	13/16 – 20 UNEF (1.409)	35,80 (1.267)	32,20 (.988)	25,10 (1.075)	27,30 (1.075)
16	00	19	*	TN7G16-0019S1L	*	TN7G16-0019S1B01	-	2,30 (.090)	23,00 (.905)	25,40 (1.000)	15/16 – 20 UNEF (1.566)	39,80 (1.511)	38,40 (1.102)	28,00 (1.200)	30,50 (1.200)
24	00	48	*	TN7G24-0048S1L	*	TN7G24-0048S1B01	-	3,50 (.137)	23,40 (.921)	38,10 (1.500)	1-7/16 – 18 UNEF (2.007)	51,00 (1.870)	47,50 (1.633)	41,50 (1.700)	43,20 (1.700)
24	04	20	*	TN7G24-0420S1L	192900-0098	TN7G24-0420S1B01	-	3,50 (.137)	23,40 (.921)	38,10 (1.500)	1-7/16 – 18 UNEF (2.007)	51,00 (1.870)	47,50 (1.633)	41,50 (1.700)	43,20 (1.700)
24	04	28	*	TN7G24-0428S1L	192900-0101	TN7G24-0428S1B01	-	3,50 (.137)	23,40 (.921)	38,10 (1.500)	1-7/16 – 18 UNEF (2.007)	51,00 (1.870)	47,50 (1.633)	41,50 (1.700)	43,20 (1.700)
24	12	19	*	TN7G24-1219S1L	192900-0104	TN7G24-1219S1B01	-	3,50 (.137)	23,40 (.921)	38,10 (1.500)	1-7/16 – 18 UNEF (2.007)	51,00 (1.870)	47,50 (1.633)	41,50 (1.700)	43,20 (1.700)

Unsealed - Without Wire Seal and Securing Nut

Shell Size	Contact Layout		Single Piece Connector		Bulk Packages (100 Connectors)		A	B	C	ØD	ØE	ØF	G	H	ØJ
	Power	Signal	Part Number	Nomenclature	Part Number	Nomenclature									
16	02	13	*	TN7U16-0213S1L	*	TN7U16-0213S1B01	35,60 (1.402)	2,30(.090)	23,00(.905)	25,40(1.000)	15/16 – 20 UNEF	39,80(1.566)	38,40(1.511)	28,00(1.102)	30,50(1.200)
24	04	20	*	TN7U24-0420S1L	*	TN7U24-0420S1B01	37,65 (1.482)	3,50(.137)	23,40(.921)	38,10(1.500)	1-7/16 – 18 UNEF	51,00(2.007)	47,50(1.870)	41,50(1.633)	43,20(1.700)
24	04	28	*	TN7U24-0428S1L	*	TN7U24-0428S1B01	37,65 (1.482)	3,50(.137)	23,40(.921)	38,10(1.500)	1-7/16 – 18 UNEF	51,00(2.007)	47,50(1.870)	41,50(1.633)	43,20(1.700)
24	12	19	*	TN7U24-1219S1L	*	TN7U24-1219S1B01	37,65 (1.482)	3,50(.137)	23,40(.921)	38,10(1.500)	1-7/16 – 18 UNEF	51,00(2.007)	47,50(1.870)	41,50(1.633)	43,20(1.700)

* For details please consult the factory



Dimensions shown in mm (inch)
Specifications and dimensions subject to change



Reversed Plugs
for Socket Contacts
Metal Locking Ring

- For Wire Sealing Ranges, see page 34.
- Accepts socket contacts, see page 60.
- Water sealed to IP67.



With Wire Seal and Securing Nut

Shell Size	Contact Layout		Single Piece Connector		Bulk Packages (100 Connectors)		A	ØB	ØC	D
	Power Contacts	Signal Contacts	Part Number	Nomenclature	Part Number	Nomenclature				
14	00	12	192900-0236	TN6S14-0012S1L	192900-0241	TN6S14-0012S1B	31,60 (1.244)	24,30 (.957)	28,00 (1.102)	19,10 ±0,20 (.751 ±.007)
16	00	19	192900-0057	TN6S16-0019S1L	192990-9970	TN6S16-0019S1B	31,70 (1.248)	27,00 (1.063)	30,20 (1.189)	19,10 ±0,20 (.751 ±.007)
16	02	13	192900-0581	TN6S16-0213S1L	*	TN6S16-0213S1B	31,70 (1.248)	27,00 (1.063)	30,20 (1.189)	19,10 ±0,20 (.751 ±.007)
24	00	48	192900-0425	TN6S24-0048S1L	192900-0428	TN6S24-0048S1B	32,40 (1.275)	40,50 (1.594)	44,00 (1.732)	14,72 ±0,15 (.580 ±.006)
24	04	20	192900-0054	TN6S24-0420S1L	192990-9450	TN6S24-0420S1B	32,40 (1.275)	40,50 (1.594)	44,00 (1.732)	14,72 ±0,15 (.580 ±.006)
24	04	28	192900-0055	TN6S24-0428S1L	192900-0053	TN6S24-0428S1B	32,40 (1.275)	40,50 (1.594)	44,00 (1.732)	14,72 ±0,15 (.580 ±.006)
24	12	19	192900-0056	TN6S24-1219S1L	192990-9240	TN6S24-1219S1B	32,40 (1.275)	40,50 (1.594)	44,00 (1.732)	14,72 ±0,15 (.580 ±.006)
24	00	48 (L)	192991-0648	TN6LS24-0048S1L	*	TN6LS24-0048S1B	43,00 (1.693)	40,50 (1.594)	44,00 (1.732)	14,72 ±0,15 (.580 ±.006)

Without Securing Nut

Shell Size	Contact Layout		Single Piece Connector		Bulk Packages (100 Connectors)		A	ØB	ØC	D
	Power Contacts	Signal Contacts	Part Number	Nomenclature	Part Number	Nomenclature				
14	00	12	*	TN6G14-0012S1L	192900-0242	TN6G14-0012S1B	-	13/16-20 UNEF	28,00 (1.102)	19,10 ±0,20 (.751 ±.007)
16	00	19	*	TN6G16-0019S1L	192900-0109	TN6G16-0019S1B	-	15/16-20 UNEF	30,20 (1.189)	19,10 ±0,20 (.751 ±.007)
24	00	48	*	TN6G24-0048S1L	192900-0429	TN6G24-0048S1B	-	1-7/16-18 UNEF	44,00 (1.732)	14,72 ±0,15 (.580 ±.006)
24	04	20	*	TN6G24-0420S1L	192900-0106	TN6G24-0420S1B	-	1-7/16-18 UNEF	44,00 (1.732)	14,72 ±0,15 (.580 ±.006)
24	04	28	*	TN6G24-0428S1L	192900-0107	TN6G24-0428S1B	-	1-7/16-18 UNEF	44,00 (1.732)	14,72 ±0,15 (.580 ±.006)
24	12	19	*	TN6G24-1219S1L	192900-0108	TN6G24-1219S1B	-	1-7/16-18 UNEF	44,00 (1.732)	14,72 ±0,15 (.580 ±.006)

Unsealed - Without Wire Seal and Securing Nut

Shell Size	Contact Layout		Single Piece Connector		Bulk Packages (100 Connectors)		A	ØB	ØC	D
	Power Contacts	Signal Contacts	Part Number	Nomenclature	Part Number	Nomenclature				
16	02	13	*	TN6U16-0213S1L	*	TN6U16-0213S1B	27,55 (1.085)	15/16-20 UNEF	30,20 (1.189)	19,10 ±0,20 (.751 ±.007)
24	04	20	*	TN6U24-0420S1L	*	TN6U24-0420S1B	28,10 (1.106)	1-7/16-18 UNEF	44,00 (1.732)	14,72 ±0,15 (.580 ±.006)
24	04	28	*	TN6U24-0428S1L	*	TN6U24-0428S1B	28,10 (1.106)	1-7/16-18 UNEF	44,00 (1.732)	14,72 ±0,15 (.580 ±.006)
24	12	19	*	TN6U24-1219S1L	*	TN6U24-1219S1B	28,10 (1.106)	1-7/16-18 UNEF	44,00 (1.732)	14,72 ±0,15 (.580 ±.006)

* For details please consult the factory

Dimensions shown in mm (inch)
Specifications and dimensions subject to change



Reverse plugs
for Socket Contacts
Plastic Locking Ring



- For Wire Sealing Ranges, see page 34.
- Accepts socket contacts, see page 60.
- Water sealed to IP67.

With Wire Seal and Securing Nut

Shell Size	Contact Layout		Single Piece Connector		Bulk Packages (100 Connectors)		A	ØB	ØC
	Power Contacts	Signal Contacts	Part Number	Nomenclature	Part Number	Nomenclature			
16	00	19	192900-0558	TN6S16-0019S2L	192900-0560	TN6S16-0019S2B	31,70 (1.248)	27,00 (1.063)	32,80 (1.291)
16	02	13	192900-0562	TN6S16-0213S2L	192900-0564	TN6S16-0213S2B	31,70 (1.248)	27,00 (1.063)	32,80 (1.291)
24	00	48	192900-0542	TN6S24-0048S2L	192900-0548	TN6S24-0048S2B	32,40 (1.275)	40,50 (1.594)	44,00 (1.732)
24	04	20	192900-0540	TN6S24-0420S2L	*	TN6S24-0420S2B	32,40 (1.275)	40,50 (1.594)	44,00 (1.732)
24	04	28	192900-0550	TN6S24-0428S2L	192900-0552	TN6S24-0428S2B	32,40 (1.275)	40,50 (1.594)	44,00 (1.732)
24	12	19	192900-0541	TN6S24-1219S2L	192900-0547	TN6S24-1219S2B	32,40 (1.275)	40,50 (1.594)	44,00 (1.732)
24	00	48 (L)	192991-0664	TN6LS24-0048S2L	*	TN6LS24-0048S2B	43,00 (1.693)	40,50 (1.594)	44,00 (1.732)

Unsealed - Without Wire Seal and Securing Nut

Shell Size	Contact Layout		Single Piece Connector		Bulk Packages (100 Connectors)		A	ØB	ØC
	Power Contacts	Signal Contacts	Part Number	Nomenclature	Part Number	Nomenclature			
16	02	13	*	TN6U16-0213S2L	*	TN6U16-0213S2B	27,55 (1.085)	15/16 – 20 UNEF	32,80 (1.291)
24	04	20	*	TN6U24-0420S2L	*	TN6U24-0420S2B	28,10 (1.106)	1-7/16 – 18 UNEF	44,00 (1.732)
24	04	28	*	TN6U24-0428S2L	*	TN6U24-0428S2B	28,10 (1.106)	1-7/16 – 18 UNEF	44,00 (1.732)
24	12	19	*	TN6U24-1219S2L	*	TN6U24-1219S2B	28,10 (1.106)	1-7/16 – 18 UNEF	44,00 (1.732)

* For details please consult the factory



Reversed Receptacle for Pin Contacts
Flange Mounting

- For Wire Sealing Ranges, see page 34.
- 3,00 (.118) max with Panel Gasket. For Panel Gaskets, see page 47.



ØJ = Flange in Front of Panel
ØK = Flange at Rear of Panel

With Wire Seal and Securing Nut

Shell Size	Contact Layout		Single Piece Connector		Bulk Packages (100 Connectors)		A	B	C	ØD	ØE	F	G	ØH	ØJ	ØK
	Power Contacts	Signal Contacts	Part Number	Nomenclature	Part Number	Nomenclature										
14	00	12	192900-0256	TN0S14-0012P1L	192900-0261	TN0S14-0012P1B	39,70 (1.563)	2,30 (.090)	11,40 (.448)	22,20 (.874)	24,30 (.956)	28,60 (1.122)	22,90 (.901)	3,20 (.125)	24,60 (.968)	24,60 (.968)
16	00	19	192900-0078	TN0S16-0019P1L	192990-9980	TN0S16-0019P1B	39,80 (1.566)	2,30 (.090)	11,40 (.448)	25,40 (1.000)	27,00 (1.063)	31,00 (1.220)	24,50 (.964)	3,20 (.125)	28,10 (1.106)	28,10 (1.106)
16	02	13	192900-0582	TN0S16-0213P1L	*	TN0S16-0213P1B	39,80 (1.566)	2,30 (.090)	11,40 (.448)	25,40 (1.000)	27,00 (1.063)	31,00 (1.220)	24,50 (.964)	3,20 (.125)	28,10 (1.106)	28,10 (1.106)
24	00	48	192900-0431	TN0S24-0048P1L	192900-0434	TN0S24-0048P1B	41,80 (1.645)	3,50 (.137)	15,40 (.606)	38,10 (1.500)	40,10 (1.578)	50,80 (2.000)	39,70 (1.563)	4,20 (.165)	41,00 (1.614)	41,00 (1.614)
24	04	20	192900-0069	TN0S24-0420P1L	192990-9440	TN0S24-0420P1B	41,80 (1.645)	3,50 (.137)	15,40 (.606)	38,10 (1.500)	40,10 (1.578)	50,80 (2.000)	39,70 (1.563)	4,20 (.165)	41,00 (1.614)	41,00 (1.614)
24	04	28	192900-0072	TN0S24-0428P1L	192900-0064	TN0S24-0428P1B	41,80 (1.645)	3,50 (.137)	15,40 (.606)	38,10 (1.500)	40,10 (1.578)	50,80 (2.000)	39,70 (1.563)	4,20 (.165)	41,00 (1.614)	41,00 (1.614)
24	12	19	192900-0075	TN0S24-1219P1L	192990-9250	TN0S24-1219P1B	41,80 (1.645)	3,50 (.137)	15,40 (.606)	38,10 (1.500)	40,10 (1.578)	50,80 (2.000)	39,70 (1.563)	4,20 (.165)	41,00 (1.614)	41,00 (1.614)
24	00	48 (L)	192991-0652	TN0LS24-0048P1L	*	TN0LS24-0048P1B	52,70 (2.075)	3,50 (.137)	15,40 (.606)	38,10 (1.500)	40,10 (1.578)	50,80 (2.000)	39,70 (1.563)	4,20 (.165)	41,00 (1.614)	41,00 (1.614)

Without Securing Nut

Shell Size	Contact Layout		Single Piece Connector		Bulk Packages (100 Connectors)		A	B	C	ØD	ØE	F	G	ØH	ØJ	ØK
	Power Contacts	Signal Contacts	Part Number	Nomenclature	Part Number	Nomenclature										
14	00	12	*	TN0G14-0012P1L	192900-0262	TN0G14-0012P1B	-	2,30 (.090)	11,40 (.448)	22,20 (.874)	15/16 – 20 UNEF	28,60 (1.122)	22,90 (.901)	3,20 (.125)	24,60 (.968)	24,60 (.968)
16	00	19	*	TN0G16-0019P1L	192900-0119	TN0G16-0019P1B	-	2,30 (.090)	11,40 (.448)	25,40 (1.000)	15/16 – 20 UNEF	31,00 (1.220)	24,50 (.964)	3,20 (.125)	28,10 (1.106)	28,10 (1.106)
24	00	48	*	TN0G24-0048P1L	192900-0435	TN0G24-0048P1B	-	3,50 (.137)	15,40 (.606)	38,10 (1.500)	1-7/16 – 18 UNEF	50,80 (2.000)	39,70 (1.563)	4,20 (.165)	41,00 (1.614)	41,00 (1.614)
24	04	20	*	TN0G24-0420P1L	192900-0110	TN0G24-0420P1B	-	3,50 (.137)	15,40 (.606)	38,10 (1.500)	1-7/16 – 18 UNEF	50,80 (2.000)	39,70 (1.563)	4,20 (.165)	41,00 (1.614)	41,00 (1.614)
24	04	28	*	TN0G24-0428P1L	192900-0113	TN0G24-0428P1B	-	3,50 (.137)	15,40 (.606)	38,10 (1.500)	1-7/16 – 18 UNEF	50,80 (2.000)	39,70 (1.563)	4,20 (.165)	41,00 (1.614)	41,00 (1.614)
24	12	19	*	TN0G24-1219P1L	192900-0116	TN0G24-1219P1B	-	3,50 (.137)	15,40 (.606)	38,10 (1.500)	1-7/16 – 18 UNEF	50,80 (2.000)	39,70 (1.563)	4,20 (.165)	41,00 (1.614)	41,00 (1.614)

* For details please consult the factory

Dimensions shown in mm (inch)
Specifications and dimensions subject to change



Reversed Receptacle
for Pin Contacts
Jam Nut Mounting



• For Wire Sealing Ranges, see page 34.

- Panel thickness 4,00 (.157) max
- 3,00 (.118) max with Panel gasket.
- For Panel Gaskets, see page 47.
- Bulk packages are not supplied with Jam Nuts. To order Jam Nuts see page 47.

With Wire Seal and Securing Nut

Shell Size	Contact Layout		Single Piece Connector		Bulk Packages (100 Connectors)		A	B	C	ØD	ØE	ØF	G	H	ØJ
	Power	Signal	Part Number	Nomenclature	Part Number	Nomenclature									
14	00	12	192900-0266	TN7S14-0012P1L	192900-0271	TN7S14-0012P1B01	39,70 (1.563)	3,50 (.137)	22,10 (.870)	22,20 (.874)	24,30 (.956)	35,80 (1.409)	32,20 (1.267)	25,10 (.988)	27,30 (1.075)
16	00	19	192900-0353	TN7S16-0019P1L	192900-0395	TN7S16-0019P1B01	39,80 (1.566)	2,30 (.090)	23,00 (.905)	25,40 (1.000)	27,00 (1.063)	39,80 (1.566)	38,40 (1.511)	28,00 (1.102)	30,50 (1.200)
16	02	13	192900-0583	TN7S16-0213P1L	192900-0586	TN7S16-0213P1B01	39,80 (1.566)	2,30 (.090)	23,00 (.905)	25,40 (1.000)	27,00 (1.063)	39,80 (1.566)	38,40 (1.511)	28,00 (1.102)	30,50 (1.200)
24	00	48	192900-0437	TN7S24-0048P1L	192900-0440	TN7S24-0048P1B01	41,80 (1.645)	3,50 (.137)	23,40 (.921)	38,10 (1.500)	40,10 (1.578)	51,00 (2.007)	47,50 (1.870)	41,50 (1.633)	43,20 (1.700)
24	04	20	192900-0071	TN7S24-0420P1L	192990-9470	TN7S24-0420P1B01	41,80 (1.645)	3,50 (.137)	23,40 (.921)	38,10 (1.500)	40,10 (1.578)	51,00 (2.007)	47,50 (1.870)	41,50 (1.633)	43,20 (1.700)
24	04	28	192900-0074	TN7S24-0428P1L	192900-0066	TN7S24-0428P1B01	41,80 (1.645)	3,50 (.137)	23,40 (.921)	38,10 (1.500)	40,10 (1.578)	51,00 (2.007)	47,50 (1.870)	41,50 (1.633)	43,20 (1.700)
24	12	19	192900-0077	TN7S24-1219P1L	192900-0068	TN7S24-1219P1B01	41,80 (1.645)	3,50 (.137)	23,40 (.921)	38,10 (1.500)	40,10 (1.578)	51,00 (2.007)	47,50 (1.870)	41,50 (1.633)	43,20 (1.700)
24	00	48 (L)	192991-0656	TN7LS24-0048P1L	*	TN7LS24-0048P1B01	52,70 (2.075)	3,50 (.137)	23,40 (.921)	38,10 (1.500)	40,10 (1.578)	51,00 (2.007)	47,50 (1.870)	41,50 (1.633)	43,20 (1.700)

Without Securing Nut

Shell Size	Contact Layout		Single Piece Connector		Bulk Packages (100 Connectors)		A	B	C	ØD	ØE	ØF	G	H	ØJ
	Power	Signal	Part Number	Nomenclature	Part Number	Nomenclature									
14	00	12	*	TN7G14-0012P1L	192900-0370	TN7G14-0012P1B01	-	2,30 (.090)	22,10 (.870)	22,20 (.874)	15/16 – 20 UNEF	35,80 (1.409)	32,20 (1.267)	25,10 (.988)	27,30 (1.075)
16	00	19	*	TN7G16-0019P1L	192900-0396	TN7G16-0019P1B01	-	2,30 (.090)	23,00 (.905)	25,40 (1.000)	15/16 – 20 UNEF	39,80 (1.566)	38,40 (1.511)	28,00 (1.102)	30,50 (1.200)
24	00	48		192900-0438 TN7G24-0048P1L	192900-0441	TN7G24-0048P1B01	-	3,50 (.137)	23,40 (.921)	38,10 (1.500)	1-7/16 – 18 UNEF	51,00 (2.007)	47,50 (1.870)	41,50 (1.633)	43,20 (1.700)
24	04	20	*	TN7G24-0420P1L	192900-0112	TN7G24-0420P1B01	-	3,50 (.137)	23,40 (.921)	38,10 (1.500)	1-7/16 – 18 UNEF	51,00 (2.007)	47,50 (1.870)	41,50 (1.633)	43,20 (1.700)
24	04	28	*	TN7G24-0428P1L	192900-0115	TN7G24-0428P1B01	-	3,50 (.137)	23,40 (.921)	38,10 (1.500)	1-7/16 – 18 UNEF	51,00 (2.007)	47,50 (1.870)	41,50 (1.633)	43,20 (1.700)
24	12	19	*	TN7G24-1219P1L	192900-0118	TN7G24-1219P1B01	-	3,50 (.137)	23,40 (.921)	38,10 (1.500)	1-7/16 – 18 UNEF	51,00 (2.007)	47,50 (1.870)	41,50 (1.633)	43,20 (1.700)

Unsealed- Without Wire Seal and Securing Nut

Shell Size	Contact Layout		Single Piece Connector		Bulk Packages (100 Connectors)		A	B	C	ØD	ØE	ØF	G	H	ØJ
	Power	Signal	Part Number	Nomenclature	Part Number	Nomenclature									
16	02	13	*	TN7U16-0213P1L	*	TN7U16-0213P1B01	35,60 (1.402)	2,30 (.090)	23,00 (.905)	25,40 (1.000)	15/16 – 20 UNEF	39,80 (1.566)	38,40 (1.511)	28,00 (1.102)	30,50 (1.200)
24	04	20	*	TN7U24-0420P1L	*	TN7U24-0420P1B01	37,65 (1.482)	3,50 (.137)	23,40 (.921)	38,10 (1.500)	1-7/16 – 18 UNEF	51,00 (2.007)	47,50 (1.870)	41,50 (1.633)	43,20 (1.700)
24	04	28	*	TN7U24-0428P1L	*	TN7U24-0428P1B01	37,65 (1.482)	3,50 (.137)	23,40 (.921)	38,10 (1.500)	1-7/16 – 18 UNEF	51,00 (2.007)	47,50 (1.870)	41,50 (1.633)	43,20 (1.700)
24	12	19	*	TN7U24-1219P1L	*	TN7U24-1219P1B01	37,65 (1.482)	3,50 (.137)	23,40 (.921)	38,10 (1.500)	1-7/16 – 18 UNEF	51,00 (2.007)	47,50 (1.870)	41,50 (1.633)	43,20 (1.700)

* For details please consult the factory



Dimensions shown in mm (inch)
Specifications and dimensions subject to change

How to Order-Accessories

Typical Nomenclature:

TNA 24 CA01 - 20 L

Series

TNA = Trident Neptune Accessory

Shell Size

14
16
24
** Blanking Plug

Packaging

B = Bulk
L = Single Pack

Accessory Style, Type, and Size

Accessory Style, Type, and Size		
Conduit Adapter		
CA	01-xx	Type 1, xx=diameter of conduit*
CA	02-xx	Type 2, xx=diameter of conduit*
CA	03-xx	Type 3, xx=diameter of conduit*
Cable Clamp		
CC	HC-00	Sealed
CC	SR-00	Unsealed
Panel Gasket		
PG	01-00	Flange Type
PG	03-00	Jam Nut Type
Dust Cap		
DC	P0-00	Sealed Dust Cap, Plug
DC	R0-01	Sealed Dust Cap, Receptacle (Top Hat)***
Spare Jam Nut		
JN	00-00	
Blanking Plug		
BP	SG-00	For Signal Holes

*** Can be sealed up to IP 67

***Conduit Adapter Sizes**

Shell Size	Type	Diameter (mm)
14	01	12
16	01	20
16	02	18
24	01	20
24	01	25
24	02	25
24	02	26
24	03	34

Dimensions shown in mm (inch)
Specifications and dimensions subject to change



Sealed Cable Clamps for Use With Neptune Circular Connectors

- For use with jacketed cables.
- Provides Strain relief and wire protection.
- Provides sealing to IP67.
- For assembly instructions, see page 76.

* For disassembly, add 9,00 (.354) for shell sizes 14 and 16 and add 10,60 (.417) for shell size 24.

Shell Size	Part Number	Nomenclature	ØA max.	B	C max.	Wire Sealing Diameter	
						Minimum	Maximum
14	192900-0496	TNA14CCHC-00L	14,60 (.574)	22,80 (.897)	85,50 (3.366)	6,50 (.256)	12,40 (.488)
16	192900-0497	TNA16CCHC-00L	16,60 (.653)	24,70 (.972)	89,80 (3.535)	6,50 (.256)	12,40 (.488)
24	192900-0498	TNA24CCHC-00L	29,60 (1.165)	41,80 (1.645)	128,50 (5.059)	17,00 (.670)	26,50 (1.040)

* Assumes a uniformly cylindrical cable. Variations in the diameter could effect sealing.



* For disassembly, add 9,00 (.354) for shell sizes 14 and 16 and add 10,60 (.417) for shell size 24.

Unsealed Cable Clamps for Use With Neptune Circular Connectors

- Provides strain relief and wire protection.
- For use with discrete wires or jacketed cables.
- For assembly instructions, see page 76.

Shell Size	Part Number	Nomenclature	ØA max.	B	ØC max.	ØD	E
							max.
14	192900-0286	TNA14CCSR-00L	27,00 (1.063)	6,40 (.251)	13,80 (.543)	27,00 (1.063)	67,10 (2.641)
16	192900-0343	TNA16CCSR-00L	30,10 (1.185)	6,40 (.251)	17,00 (.669)	30,20 (1.189)	67,10 (2.641)
24	192900-0344	TNA24CCSR-00L	41,80 (1.645)	8,20 (.322)	28,00 (1.102)	42,50 (1.673)	90,80 (3.574)



Conduit Adapters

Adapters facilitate the fitting of various accessories to the Neptune housings.



Figure 1

Type 1

- External threads for use with conduit.



Figure 1



Figure 2

Single Piece Pack

Shell Size	Figure	Part Number	Nomenclature	A	ØB	ØC
16	1	192900-0187	TNA16CA01-20L	28,60 (1.126)	28,00 (1.102)	21,50 (.846)
24	2	192900-0184	TNA24CA01-20L	47,00 (1.850)	44,00 (1.732)	21,50 (.846)
24	1	192900-0185	TNA24CA01-25L	32,00 (1.260)	43,50 (1.713)	28,50 (1.122)



Type 2

- External grooves for heat shrink tubing or conduit "push-fit" onto the adapter.
- Standard type is recommended for sealed connections to the adapter.
- Drain hole type is recommended for non sealed connections. E.g. split conduit.

Figure 1



Standard Type

Figure 2



Drain Hole Type

Single Piece Pack

Shell Size	Figure	Part Number	Nomenclature	A	ØB	ØC
16	1	192991-0015	TNA16CA02-18L	37,80 (1.488)	27,50 (1.082)	17,40 (.685)
24	1	192991-0013	TNA24CA02-26L	46,70 (1.839)	41,50 (1.634)	24,00 (.945)
24	2	192900-0654	TNA24CA02-25L	46,70 (1.839)	41,50 (1.634)	24,00 (.945)



Type 3

- For use with a 90° elbow.
- External threads for use with conduit.



Single Piece Pack

Shell Size	Part Number	Nomenclature	A	ØB
24	192900-0226	TNA24CA03-34L	36,50 (1.437)	34,70 (1.366)

Dimensions shown in mm (inch)
Specifications and dimensions subject to change



Blanking Plugs for Signal Cavities

Blanking Plugs

- Blanking plugs are used to repair damaged seals. If the membrane seal is pierced in a position that is not normally used, then the blanking plug will restore the seal.

Note: Replacement membrane seals are also available. Contact ITT for details.



Pack of 100

Part Number	Nomenclature
192991-0018	TNA**BPSG-00B



Discriminating Pin Insertion

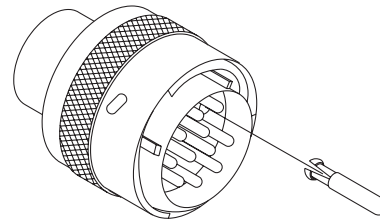

Discriminating (Keying) Pins

- Discriminating (keying) pins are used to prevent cross-mating of similar connectors. These pins are used in place of a pin contact. The corresponding socket cavity must be left open. If a socket contact is present, the discriminating pin will prevent mating.
- The discriminating pin is installed from the mating side of the connector.

Prevents Cross - Mating

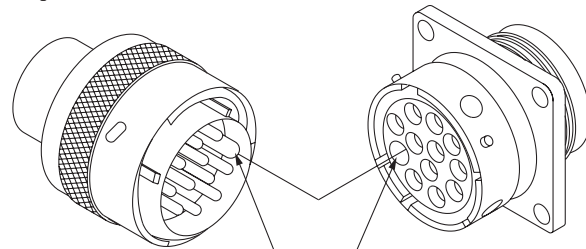

Discriminating pin Open cavity

Pin Type	Part Number (Pack of 25)
Signal	192990-0000
Power	192900-0189



Spare Jam Nuts

- To order with Bulk packaged Jam Nut Receptacles.

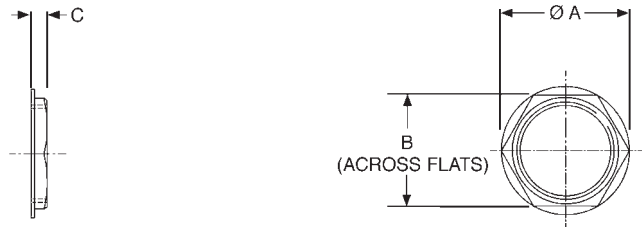

Shell	Pack of 100				
Size	Part Number	Nomenclature	ØA max.	B Nom	C
14	192900-0489	TNA14JN00-00B	36,00 (1.417)	31,00 (1.220)	6,00 (.236)
16	192900-0488	TNA16JN00-00B	40,60 (1.598)	35,00 (1.378)	6,00 (.236)
24	192900-0487	TNA24JN00-00B	56,00 (2.205)	49,00 (1.929)	7,00 (.275)



Dimensions shown in mm (inch)
Specifications and dimensions subject to change



Plug Dust Cap

Receptacle Dust Cap

Sealed Plastic Dust Caps

Plastic Dust Caps are available for both plugs and receptacles. It is immaterial whether these are standard or reversed types, only the shell size matters in determining the correct item.



Plug Dust Cap

Shell	Pack of 100		ØA	ØB	C
Size	Part Number	Nomenclature			
14	192991-0673	TNA14DCP0-00B	22,17 (.873)	28,40 (1.118)	15,00 (.591)
16	192900-0388	TNA16DCP0-00B	25,40 (1.000)	31,70 (1.248)	14,30 (.562)
24	192900-0392	TNA24DCP0-00B	38,10 (1.500)	44,40 (1.748)	16,70 (.657)

Receptacle Dust Cap

Shell	Pack of 100		ØA
Size	Part Number	Nomenclature	
14	192900-0378	TNA14DCR0-01B	28,60 (1.126)
16	192900-0379	TNA16DCR0-01B	31,70 (1.248)
24	192900-0383	TNA24DCR0-01B	44,40 (1.748)
16	192900-0718	Trident Dust Cap	31,70 (1.248)
Special			



Note: Receptacle Dust Caps are also suitable for Ringlock. For other shell sizes please consult the factory.

Flange Type

Jam Nut Type



Panel Gaskets

Flange Type

Shell Size	Pack of 100	
Part Number	Nomenclature	
14	192900-0565	TNA14PG01-00B
16	192900-0566	TNA16PG01-00B
24	192900-0567	TNA24PG01-00B

Jam Nut Type

Shell Size	Pack of 100	
Part Number	Nomenclature	
14	192900-0457	TNA14PG03-00B
16	192900-0402	TNA16PG03-00B
24	192900-0458	TNA24PG03-00B

TNM (Trident Neptune Metal) is specifically designed to meet the needs of systems that require shielding, sealing, and the extra durability of a metal shell. The combination of Trident contacts, membrane seals, and the Universal Shielded Endbell* make TNM both cost effective and easy to assemble. TNM features nickel plated zinc alloy shells and UL 94 V-0 rated thermoplastic insulators. All TNM receptacles are supplied with an interfacial seal to provide sealing between connectors to IP67. In addition, a membrane seal is available for those applications requiring the sealing of discrete wires at the rear of the connector.

In order to seal multicore jacketed cables to connectors an endbell is available. This has 'O' ring sealing to the connector and second seal to the cable jacket. All TNM Circular Connectors are RoHS Compliant.

*Patent pending



Applications

- Antennas.
- Industrial electronics.
- Heavy duty equipment.
- Servo Motors.
- Robotics/ Control Panel.
- Industrial Instrumentation.

Product Features

- Accepts all Trident signal contacts.
- Mixed signal and power contact version.
- Can be sealed to IP67.
- 360° shielding.
- Easy to assemble.
- Recognized under the component program of UL Inc. and CSA.



Performance Specifications

Operating Voltage ¹	Up to 250 V ac rms
Contact Current Rating ²	Up to 13 A; Up to 16 A with High Conductivity Contacts; Up to 30 A with Power Contacts; Up to 40 A with D Sub Contacts
Operating Temperature	-55°C to +105°C (-67°F to +221°F)
Insulation Resistance	5000MW min. at 500 V dc
Durability ³	Up to 200 Mating Cycles
Environmental Sealing	Up to IP67
Flammability	UL 94 V-0

Materials and Finishes

Shell	Nickel Plated Zinc Alloy
Insulator	Black Nylon
Coupling Ring	Nickel Plated Brass
Seal	Rubber

¹ Depends on contacts used, layout, and degree of pollution
² Depends on type and number of contacts used
³ Depends on plating and type of contacts used

Test Specifications

The table below summarizes the results of key tests performed. Data is applicable to standard connectors with standard contacts. Variations may affect this data, so please consult factory for further information on your requirements.

Test	Method	Criteria of Acceptance
Dielectric Withstanding Voltage	2000 V ac rms	No breakdown
Thermal Shock	-55°C to +125°C (-67°F to +257°F), 5 cycles	No physical damage
Physical Shock	40 g's peak, 3 axes, 6 millisecond duration half-sine pulse	No physical damage No loss of continuity > 10 μsec
Vibration	10 g's peak, 10-500 Hz, 9 hours	No physical damage No loss of continuity > 10 μsec
Durability	200 cycles of mating and unmating 200 mating cycles max.	Capable of mating and unmating and meeting contact resistance requirements
Salt Spray	48 hours	Capable of mating and unmating and meeting contact resistance requirements
High Temperature Endurance	1000 hours at 85°C (+185°F), 16 hours at 105°C (+221°F)	Insulation Resistance > 100 MW
Humidity Steady State	RH 90-95%, 40°C (+104°F) , 504 hours	Insulation Resistance > 100 MW



Dimensions shown in mm (inch)
 Specifications and dimensions subject to change

How to Order-Connectors

Typical Nomenclature: TNM 6 U 14 - 0012 S 1 L *

Series

TNM = Trident Neptune Metal

Shell Style

- 0 = Flange Receptacle (4 holes)
- 6 = Plug
- 7 = Jam Nut Receptacle (Shell Size 14 only)

Sealing Class

- S = Grommet and nut
- U = Unsealed

Modification

* = Standard

Packaging

- B = Bulk (100 pcs)
- L = Single Pack

Connector Finish Materials

1 = Standard (Nickel Plated Metal Parts)

Contact Type

- P = Pin
- S = Socket

Shell Size and Contact Arrangement

Shell Size		Number of Power Contacts	Number of Signal Contacts
10	-	00	04
12	-	00	08
14	-	00	12
14	-	03	03
14	-	03	04
16	-	00	19
16	-	04	00

Contact Cavity Arrangements

Mating Face View

Shell Size

Number of Power Contacts

Number of Signal Contacts¹

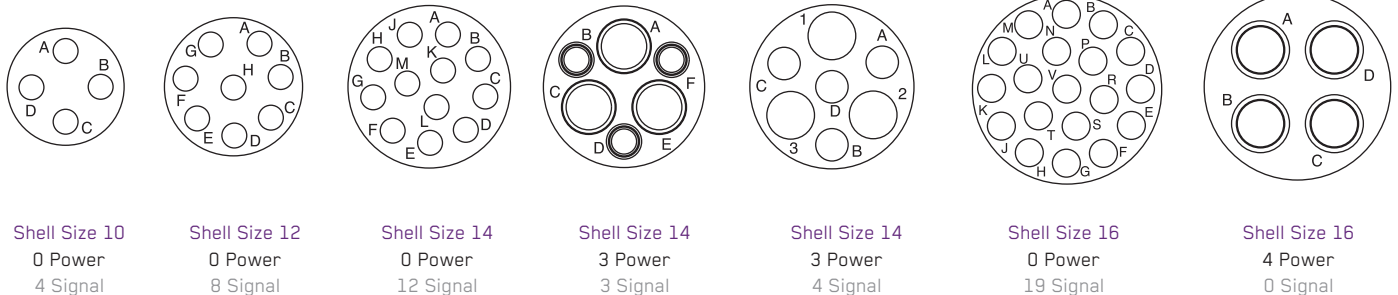

¹ Wire sealing range 1,70 to 2,70 (.066 to .106)



Standard Plugs for Pin Contacts

With Wire Seal and Securing Nut

Shell Size	Contact Layout	Part Number	Single Piece Connector			
			Nomenclature	A	Ø B	Ø C
10	00 04	192993-0011	TNM6S10-0004P1L	42,50 (1.673)	17,50 (.689)	21,60 (.850)
12	00 08	192993-0012	TNM6S12-0008P1L	42,50 (1.673)	20,60 (.811)	24,80 (.976)
14	03 04	192993-0695	TNM6S14-0304P1L	42,50 (1.673)	24,30 (.957)	28,00 (1.102)
14	00 12	192993-0013	TNM6S14-0012P1L	42,50 (1.673)	24,30 (.957)	28,00 (1.102)
16	00 19	192993-0014	TNM6S16-0019P1L	42,50 (1.673)	27,00 (1.063)	31,20 (1.229)

Unsealed – Without Wire Seal and Securing Nut ♦

Shell Size	Contact Layout	Part Number	Single Piece Connector			
			Nomenclature	A*	Ø B*	Ø C
10	00 04	192993-0001	TNM6U10-0004P1L	38,10 (1.500)	13,80 (.543)	21,60 (.850)
12	00 08	192993-0002	TNM6U12-0008P1L	38,10 (1.500)	16,90 (.665)	24,80 (.976)
14	00 12	192993-0003	TNM6U14-0012P1L	38,10 (1.500)	20,10 (.791)	28,00 (1.102)
16	00 19	192993-0004	TNM6U16-0019P1L	38,10 (1.500)	23,30 (.917)	31,20 (1.229)

* Dimensions A and B apply to connectors without wire seals and securing nuts.
 ♦ Can be sealed to IP67 with a sealed endbell, see page 55.



Panel Cutout



Ø H = Flange in Front of Panel
 Ø G = Flange at Rear of Panel

Standard Receptacles for Socket Contacts Flange Mounting

With Wire Seal and Securing Nut

Shell Size	Contact Layout	Part Number	Nomenclature	Single Piece Connector							
				A	Ø B	Ø C	D	E	Ø F	Ø G	Ø H
10	00 04	192993-0031	TNMOS10-0004S1L	34,70 (1.366)	17,50 (.689)	14,92 (.563)	23,79 (.937)	18,26 (.719)	3,20 (.126)	17,30 (.681)	15,10 (.594)
12	00 08	192993-0032	TNMOS12-0008S1L	34,70 (1.366)	20,60 (.811)	18,98 (.747)	26,15 (1.030)	20,62 (.812)	3,20 (.126)	21,80 (.858)	18,20 (.717)
14	03 04	192993-0698	TNMOS14-0304S1L	34,70 (1.366)	24,30 (.957)	22,16 (.872)	28,54 (1.124)	22,80 (.898)	3,50 (.138)	25,00 (.984)	21,40 (.843)
14	00 12	192993-0033	TNMOS14-0012S1L	34,70 (1.366)	24,30 (.957)	22,16 (.872)	28,54 (1.124)	22,80 (.898)	3,50 (.138)	25,00 (.984)	21,40 (.843)
16	00 19	192993-0034	TNMOS16-0019S1L	34,70 (1.366)	27,00 (1.063)	25,33 (.997)	30,89 (1.216)	24,40 (.961)	3,50 (.138)	28,10 (1.106)	24,60 (.969)

Unsealed - Without Wire Seal and Securing Nut ♦

Shell Size	Contact Layout	Part Number	Nomenclature	Single Piece Connector							
				A*	Ø B*	Ø C	D	E	Ø F	Ø G	Ø H
10	00 04	192993-0021	TNMOU10-0004S1L	30,30 (1.193)	14,30 (.563)	14,92 (.563)	23,79 (.937)	18,26 (.719)	3,20 (.126)	17,30 (.681)	15,10 (.594)
12	00 08	192993-0022	TNMOU12-0008S1L	30,30 (1.193)	17,40 (.685)	18,98 (.747)	26,15 (1.030)	20,62 (.812)	3,20 (.126)	21,80 (.858)	18,20 (.717)
14	00 12	192993-0023	TNMOU14-0012S1L	30,30 (1.193)	20,60 (.811)	22,16 (.872)	28,54 (1.124)	22,80 (.898)	3,50 (.138)	25,00 (.984)	21,40 (.843)
16	00 19	192993-0024	TNMOU16-0019S1L	30,30 (1.193)	23,80 (.937)	25,33 (.997)	30,89 (1.216)	24,40 (.961)	3,50 (.138)	28,10 (1.106)	24,60 (.969)

* Dimensions A and B apply to connectors without wire seals and securing nuts.
 ♦ Can be sealed to IP67 with a sealed endbell, see page 50.





Reversed Plugs for Socket Contacts

With Wire Seal and Securing Nut

Shell Size	Contact Layout	Single Piece Connector		A	ØB	ØC
		Part Number	Nomenclature			
10	00 04	192993-0051	TNM6S10-0004S1L	34,20 (1.346)	17,50 (.689)	21,60 (.850)
12	00 08	192993-0052	TNM6S12-0008S1L	34,20 (1.346)	20,60 (.811)	24,80 (.976)
14	03 04	192993-0696	TNM6S14-0304S1L	34,20 (1.346)	24,30 (.957)	28,00 (1.102)
14	00 12	192993-0053	TNM6S14-0012S1L	34,20 (1.346)	24,30 (.957)	28,00 (1.102)
16	00 19	192993-0054	TNM6S16-0019S1L	34,20 (1.346)	27,00 (1.063)	31,20 (1.229)

Unsealed – Without Wire Seal and Securing Nut ♦

Shell Size	Contact Layout	Single Piece Connector		A*	ØB*	ØC
		Part Number	Nomenclature			
10	00 04	192993-0041	TNM6U10-0004S1L	29,80 (1.173)	13,80 (.543)	21,60 (.850)
12	00 08	192993-0042	TNM6U12-0008S1L	29,80 (1.173)	16,90 (.665)	24,80 (.976)
14	00 12	192993-0043	TNM6U14-0012S1L	29,80 (1.173)	20,10 (.791)	28,00 (1.102)
16	00 19	192993-0044	TNM6U16-0019S1L	29,80 (1.173)	23,30 (.917)	31,20 (1.229)

* Dimensions A and B apply to connectors without wire seals and securing nuts
 ♦ Can be sealed to IP67 with a sealed endbell, see page 55.



Reversed Receptacles for Pin Contacts Flange Mounting

With Wire Seal and Securing Nut

Shell Size	Contact Layouts	Single Piece Connector		A	ØB	ØC	D	E	ØF	ØG	ØH
		Part Number	Nomenclature								
10	00 04	192993-0071	TNMOS10-0004P1L	43,00 (1.693)	17,50 (.689)	14,92 (.563)	23,79 (.937)	18,26 (.719)	3,20 (.126)	17,30 (.681)	15,10 (.594)
12	00 08	192993-0072	TNMOS12-0008P1L	43,00 (1.693)	20,60 (.811)	18,98 (.747)	26,15 (1.030)	20,62 (.812)	3,20 (.126)	21,80 (.858)	18,20 (.717)
14	03 04	192993-0697	TNMOS14-0304P1L	43,00 (1.693)	24,30 (.957)	22,16 (.872)	28,54 (1.124)	22,80 (.898)	3,50 (.138)	25,00 (.984)	21,40 (.843)
14	00 12	192993-0073	TNMOS14-0012P1L	43,00 (1.693)	24,30 (.957)	22,16 (.872)	28,54 (1.124)	22,80 (.898)	3,50 (.138)	25,00 (.984)	21,40 (.843)
16	00 19	192993-0074	TNMOS16-0019P1L	43,00 (1.693)	27,00 (1.063)	25,33 (.997)	30,89 (1.216)	24,40 (.961)	3,50 (.138)	28,10 (1.106)	24,60 (.969)

Unsealed - Without Wire Seal and Securing Nut ♦

Shell Size	Contact Layouts	Single Piece Connector		A*	ØB*	ØC	D	E	ØF	ØG	ØH
		Part Number	Nomenclature								
10	00 04	192993-0061	TNMOSU10-0004P1L	38,60 (1.520)	14,30 (.563)	14,92 (.563)	23,79 (.937)	18,26 (.719)	3,20 (.126)	17,30 (.681)	15,10 (.594)
12	00 08	192993-0062	TNMOSU12-0008P1L	38,60 (1.520)	17,40 (.685)	18,98 (.747)	26,15 (1.030)	20,62 (.812)	3,20 (.126)	21,80 (.858)	18,20 (.717)
14	00 12	192993-0063	TNMOSU14-0012P1L	38,60 (1.520)	20,60 (.811)	22,16 (.872)	28,54 (1.124)	22,80 (.898)	3,50 (.138)	25,00 (.984)	21,40 (.843)
16	00 19	192993-0064	TNMOSU16-0019P1L	38,60 (1.520)	23,80 (.937)	25,33 (.997)	30,89 (1.216)	24,40 (.961)	3,50 (.138)	28,10 (1.106)	24,60 (.969)

* Dimensions A and B apply to connectors without wire seals and securing nuts
 ♦ Can be sealed to IP67 with a sealed endbell, see page 55.



Standard/Reversed Receptacles for Pin/Socket Contacts
Jam Nut Mounting



- Mates with Standard and Reversed Plugs, see pages 50-51.

With Wire Seal and Securing Nut

Shell Size	Contact Layout	Type	Single Piece Connector		A	B	C	ØD	ØE	ØF	ØG
			Part Number	Nomenclature							
14	03 04	Standard	192993-0700	TNM7S14-0304S1L	50,00 (1.968)	2,80 (.110)	17,60 (.692)	22,20 (.874)	24,30 (.956)	38,09 (1.500)	34,90(1.374)
14	03 04	Reversed	192993-0699	TNM7S14-0304P1L	50,00 (1.968)	2,80 (.110)	17,60 (.692)	22,20 (.874)	24,30 (.956)	38,09 (1.500)	34,90(1.374)



4-way Reversed Plug/Receptacle for Power Contacts

This connector was developed for use on servomotors where high currents and high voltages are used.

- Uses Cannon D Subminiature power contacts, see page 67.
- Voltage rating 500V.
- Current rating 40A.
- Short receptacle to save space.

Single Piece Connector

Shell Size	Contact Type	Layout	Single Piece Connector		A	B	C	D	E	F	G	H	I	J
			Part Number	Nomenclature										
16	Reversed Receptacle	04 00	192993-0106	TNM192993-0106	30,3	1,85	11,6	23,7	25,33	30,9	24,4	24,6	28,1	3,5
16	Reversed Plug	04 00	192993-0105	TNM192993-0105	29,8	19,1	23,2	31,2						
16	Earth Plug	04 00	192993-0109	TNM192993-0109	29,8	19,1	23,2	31,2						



Dimensions shown in mm (inch)
Specifications and dimensions subject to change

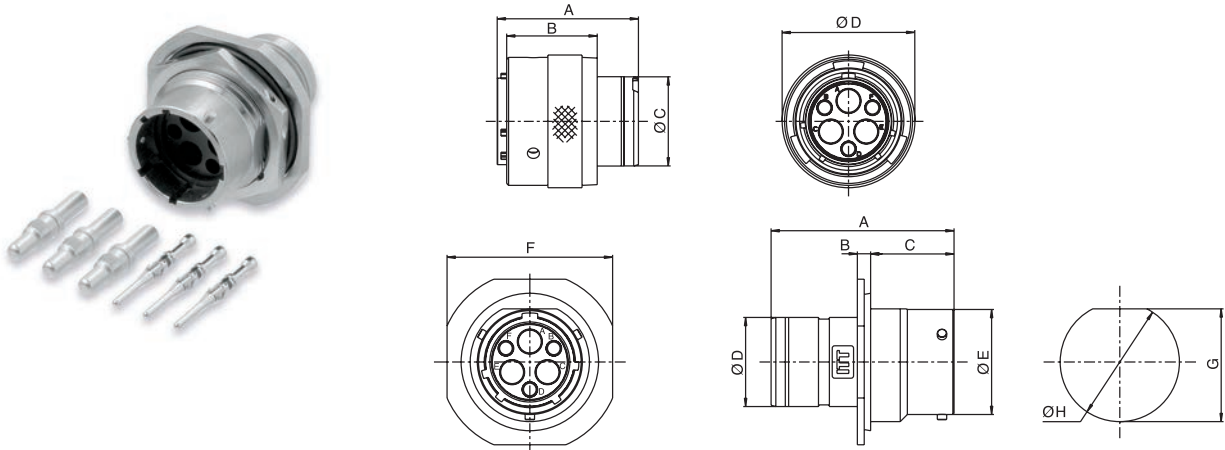

3-3 Connector

Designed for use as an antenna connector, this design incorporates D Subminiature power contacts and standard Trident signal contacts.

- Can terminate wire sizes up to 8 AWG (10 mm²)
- Large cables with outside diameters up to 16,00 (.630) diameter can be accommodated.
- Uses Cannon D Subminiature power contacts see page 67.

For more information, please contact your local Cannon sales office.

Shell Size	Contact Layouts	Type	Part Number	A	B	C	D	E	F	G	H
14	03 03	Reversed Receptacle Pin	192993-2013	38,6	2,8	17,6	18,8	22,16	34,9	24,2	25,8
14	03 03	Reversed Plug Socket	192993-0261	29,8	19,1	18,85	28				

How to Order-Accessories

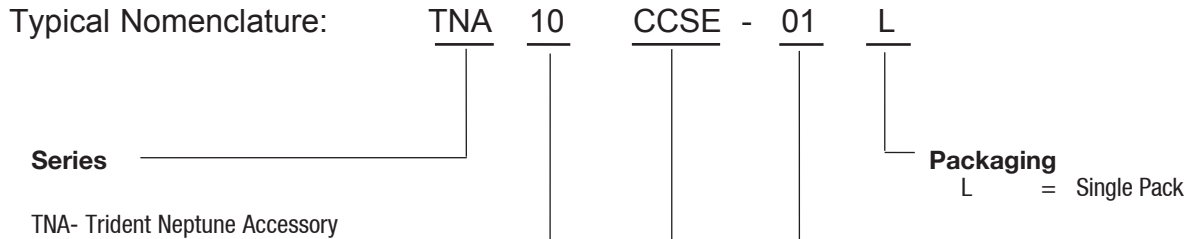

Accessory Style, Type and Size		
Cable Clamp		
CC	HC-00	Sealed
CC	SR-00	Unsealed
CC	SE-00	Universal Shielded Endbell
CC	SE-01	Shielded Endbell for larger Cable Sizes
Heat Shrink Adapter		
HS	AD-00	Heat Shrink Adapter



Shielded Endbell for Larger Cable Sizes

- Metal body with plastic cable clamp.
- For assembly instructions, see page 77.
- For use with jacketed cables.

Shell Size	Part Number	Nomenclature	Ø A max	Cable Accommodation Outer Sheath Diameter		Ø C	Ø D max
				Ø B min	Ø B max		
10	192993-0091	TNA10CCSE-01L	18,10 (.712)	5,00 (.196)	10,0 (.393)	19,00 (.748)	70,00 (2.755)
12	192993-0092	TNA12CCSE-01L	21,20 (.834)	6,00 (.236)	12,00 (.472)	21,00 (.826)	72,00 (2.834)
14	192993-0093	TNA14CCSE-01L	24,20 (.952)	7,00 (.275)	14,00 (.551)	23,00 (.905)	78,00 (3.070)
16	192993-0094	TNA16CCSE-01L	27,60 (1.086)	8,00 (.314)	16,00 (.629)	25,00 (.984)	82,50 (3.248)



Heat Shrink Adapter for use with TNM Circular Connectors

Shell Size	Part Number	Nomenclature	Ø Amax	Ø B min	Ø C	Ø Dmax
12	192993-0632	TNA12HSAD-00L	21,20 (.834)	12,20 (.480)	18,00 (.708)	36,00 (1.417)
14	192993-0633	TNA14HSAD-00L	24,20 (.952)	14,20 (.559)	20,00 (.787)	36,00 (1.417)
16	192993-0634	TNA16HSAD-00L	27,60 (1.086)	16,30 (.641)	22,00 (.866)	36,50 (1.437)



Dimensions shown in mm (inch)
Specifications and dimensions subject to change



Universal Shielded Endbell*

In order to meet EMC requirements it will be necessary to fit a shielded endbell to the TNM connectors. The TNM Shielded Endbell provides sealing to the connector shell, a cable braid grip and sealing to the outer sheath of the cable. Sealing rating is IP67.

Shielded endbells are used with unsealed plugs and receptacles.

*Patent Pending

Materials and Finishes

Description	Material/Finish
Housing	Aluminum/Nickel
Grounding Ring	Aluminum/Nickel
Clamp Nut	Aluminum/Nickel
Cable Grip	Nylon, UL 94 V-0
Support Sleeve	Nylon, UL 94 V-0
O-Ring	Rubber
Cable Seal	Rubber



For assembly instruction, see page 80.

Dimensions

Shell Size	Part Number	Nomenclature	A	ØB	ØC	D	E max.	
							Standard Format	Reversed Format
10	192993-0081	TNA10CCSE-00L	56,60 (2.228)	8,00 (.315)	17,90 (.705)	16,00 (.630)	88,50 (3.484)	80,00 (3.150)
12	192993-0082	TNA12CCSE-00L	56,70 (2.320)	10,00 (.394)	21,00 (.827)	19,00 (.748)	88,50 (3.484)	80,00 (3.150)
14	192993-0083	TNA14CCSE-00L	57,00 (2.441)	11,30 (.449)	24,00 (.945)	22,00 (.886)	88,50 (3.484)	80,00 (3.150)
16	192993-0084	TNA16CCSE-00L	57,40 (2.260)	13,60 (.535)	27,40 (1,079)	25,00 (.984)	88,50 (3.484)	80,00 (3.150)

Cables

The TNM Shielded Endbell covers a wide range of multicore cable used in industrial applications. The following table indicates the sizes that can be accommodated provided the outside sheath diameter is within the accommodation range shown.

Endbell Shell Size	Number of Signal Contacts	Cable Accommodation Outer Sheath Size	
		Minimum	Maximum
10	4	4,40 (.173)	7,30 (.287)
12	8	6,40 (.252)	9,50 (.374)
14	12	8,50 (.334)	10,20 (.402)
16	19	7,90 (.311)	12,60 (.496)

For detail of contacts, see page 59.

Shielded cable to Endbell Assembly Instructions are supplied with the Endbell piece parts kit, also shown on page 76.



Sealed Cable Clamps
for use with TNM Circular
Connectors

* For disassembly, add 9,000 (.0354) for shell sizes 10-16.

- For use with jacketed cables.
- Provides strain relief and wire protection.
- Provides sealing to IP67.
- For assembly instructions, see page 75.

Shell Size	Part Number	Nomenclature	Dimensions			
			ØA max.	B	C max.	
					Standard Format	Reversed Format
10	192900-0636	TNA10CCHC-00L	11,10 (.437)	18,80 (.740)	89,00 (3.504)	80,70 (3.177)
12	192900-0637	TNA12CCHC-00L	13,60 (.535)	20,80 (.818)	92,00 (3.622)	83,70 (3.295)
14	192900-0496	TNA14CCHC-00L	14,60 (.574)	22,80 (.897)	99,00 (3.898)	90,70 (3.571)
16	192900-0497	TNA16CCHC-00L	16,60 (.653)	24,70 (.972)	103,00 (4.055)	94,70 (3.728)

* Assumes a uniformly cylindrical cable. Variations in the diameter could effect sealing.



* For disassembly, add 9,000 (.0354) for shell sizes 10-16.

Unsealed Cable Clamps
for use with TNM Circular Connectors

- Provides strain relief and wire protection.
- For use with discrete wires or jacketed cables.
- For assembly instructions, see page 75.

Shell Size	Part Number	Nomenclature	Dimensions					
			ØA max.	B	ØC max.	ØD	E max.	
							Standard Format	Reversed Format
10	192900-0639	TNA10CCSR-00L	21,50 (.846)	6,40 (.251)	8,70 (.342)	21,00 (.826)	74,50 (2.933)	66,20 (2.606)
12	192900-0640	TNA12CCSR-00L	24,90 (.980)	6,40 (.251)	12,80 (.503)	24,00 (.944)	74,50 (2.933)	66,20 (2.606)
14	192900-0286	TNA14CCSR-00L	27,00 (1.063)	6,40 (.251)	13,80 (.543)	27,00 (1.063)	80,50 (3.169)	71,80 (2.826)
16	192900-0343	TNA16CCSR-00L	30,10 (1.185)	6,40 (.251)	17,00 (.669)	30,20 (1.189)	80,50 (3.169)	71,80 (2.826)



This connector series is based on the Trident Neptune Metal housing. The insulator body has been designed for high voltage applications. These connectors rated for up to 34 A (for wire size 4,0 mm² at 20°C) and 500 V ac. This connector series is VDE certified.



Performance Specifications

Electrical Data

Operating Voltage	Up to 500 V (dc and ac)
Contact Current Rating	Max. 34 A for wire size 4,0 mm ² at 20°C
Contact Resistance	5mOhm max.
Voltage Proof	6kV rated impulse voltage
Insulation Resistance	5000MOhm

Mechanical Data

Durability	Up to 200 Mating cycles, depending on contact type
Mating Torque	Max. 2,3 Nm
Unmating Torque	Min. 0,25 Nm to max. 2,3 Nm

Environmental Data (acc. ISO 15170)

Operating Temperature	-40°C to +125°C (-40°F to +257°F)
Humidity Steady State	RH 90 to 95%, 40°C, 504 hours
Environmental Sealing	IP67 in mated condition
Salt Spray	48 hours
Vibration	10 g's peak, 10 to 500 Hz, 9 hours
Physical Shock	40 g's peak, 6msec., half-spine pulse

Materials and Finishes

Shell	Nickel Plated Zinc Alloy
Insulator	Orange Nylon
Coupling Ring	Nickel Plated Brass
Flammability	UL 94 V-0



Attention! Connector must not be disconnected under load!



Dimensions: Standard Receptacle

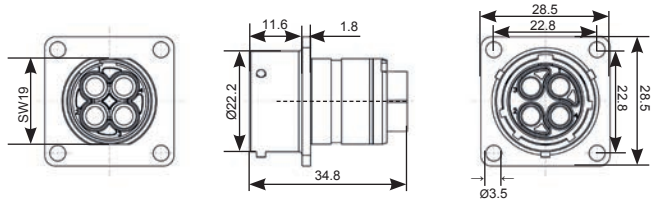

Dimensions: Standard Plug with Endbell



High Voltage 4-way for Power Contacts

- Standard and reversed version available.
- Uses APK Power contacts, see page 61.
- For sealing the receptacle use panel gasket, see page 47.

Shell Size	Type	Contact Layout	Part Number	Nomenclature
14	Standard Plug with Endbell*	04-00	192993-0702	THV6U14-0400P1L-02
14	Standard Receptacle*	04-00	192993-0704	THV0U14-0400S1L-02
14	Reversed Plug with Endbell**	04-00	192993-0706	THV6U14-0400S1L-02
14	Reversed Receptacle**	04-00	192993-0708	THV0U14-0400P1L-02

* Parts are VDE-qualified.
 ** Parts are not VDE-qualified.



High Voltage 4-way Jam Nut Receptacle for Power Contacts

Information available upon request.

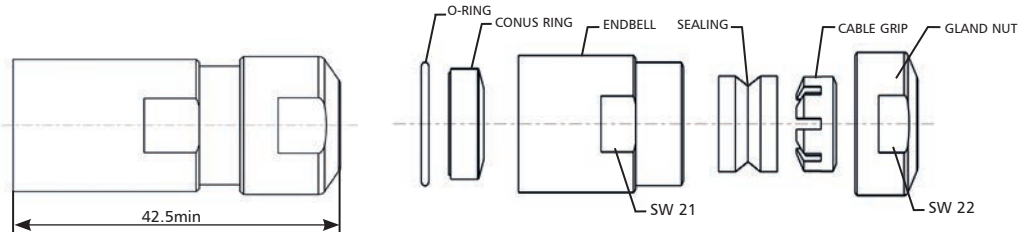

Shielded Endbell

Part Number (Pack of 100)
 192993-0087



Dimensions shown in mm (inch)
 Specifications and dimensions subject to change

General recommendations for the selection of Trident contacts are listed below.

Platings: Tin is recommended for most applications (with 50 or fewer mating cycles). It is cost effective and matches well to most wires. Gold is preferred for special situations. Gold resists oxidation, has high surface conductivity, and has a low coefficient of friction. These features make gold the preferred plating for low level signals (a rule of thumb is <100 mA), corrosive environments (for unsealed connectors), and for increased mating cycles. The electrical performance of the contact is determined at the surface of the contact. For this reason, flash gold platings are suitable for applications with 50 or fewer mating cycles. Thicker gold platings are recommended for more than 50 mating cycles. All Trident Contacts are RoHS Compliant.



Stamped versus Machined: The two part stamped contacts are manufactured to precise tolerances and are field proven. They



can be supplied on reels which lowers assembly costs for volume production. Machined contacts offer improved precision and durability. They are recommended for applications with more than 200 mating cycles.

Crimp versus Solder: Crimp contacts offer improved electrical performance, strain relief and quality control compared to solder cup contacts. Solder cup contacts are recommended for low

volume and prototype applications where the added cost of crimp tools is not justified.

High Conductivity: These contacts use a different base material than the standard contacts. They are recommended for high current applications. These contacts will also reduce the derating of connectors with several high current lines.

Temperature/Current Rating

Derating curves define the max. current that can be applied to a connector at a given ambient temperature so that the additional temperature rise caused by the current does not exceed the material limit of the connector.

The following curves show the max. currents based on the assumption attached: As factors like current load per contact, wire size etc. may be different in your application. This chart is an indication only.

- Derived in accordance with IEC 512-3, Test 5b.
- Figures are for maximum wire sizes. Smaller wires will reduce rating.
- All contacts equally loaded.
- PCB mounted connectors will be limited by PCB performance.
- Bunched cables will further reduce values.
- Cable insulation type will affect temperature and loading.
- Figures are for maximum connector sizes in each range. Smaller connectors will increase rating.



Dimensions shown in mm (inch)
Specifications and dimensions subject to change

	T2P <ul style="list-style-type: none"> • Two piece formed (stamped) contact • For up to 200 mating cycles • Full support tooling available 		T3P <ul style="list-style-type: none"> • Three piece machined contact • For up to 500 mating cycles • Full support tooling available 		
	Standard Crimp 	High Conductivity Crimp 	Machined Crimp 	Solder Cup 	Flow Solder (PCB) 
Technical and Performance Data					
Supported wire sizes	AWG 14 to 26	AWG 14 to 26	AWG 16 to 26	AWG 14 to 26	-
Current rating	13 A	16 A	13 A	13 A	Up to 30 A
Contact Resistance (initial)	5 mW	5 mW	5 mW	5 mW	5 mW
Mechanical endurance	Up to 200 insertions	Up to 200 insertions	Up to 500 insertions	Up to 500 insertions	Up to 500 insertions
Body material	Brass	Copper Alloy	Brass	Brass	Brass
Retention spring material	Stainless Steel	Stainless Steel	Beryllium Copper	Beryllium Copper	Beryllium Copper
Contact retention force (minimum)	67 N	67 N	67 N	67 N	67 N
Plating Availability					
Tin	Yes	Yes	Yes	Yes	Yes
Gold Flash (0,1 μm)	Yes	Yes	Yes	Yes	Yes
Gold	0,75 μm	0,75 μm	0,4 μm (pin) 0,75 μm (socket)	0,4 μm (pin) 0,75 μm (socket)	0,4 μm (pin) 0,75 μm (socket)
Connector/Contact Capability					
Snap Together Rectangular, Slimline (TST) and Flame Retardant (TFR)	Yes	Yes	Yes	Yes	Yes, pre-installed in connectors
Ringlock (TR)	Yes	Yes	Yes	Yes	Yes
Neptune (TN)	Yes	Yes	Yes	Yes	Yes
Neptune Metal (TNM)	Yes	Yes	Yes	Yes	-
High Voltage (THV)	—	—	—	—	—
Page Number					
	63	63	65	66	66

	High Power <ul style="list-style-type: none"> • For mixed Neptune and TNM layouts • Full support tooling available 	
	APK25 	D Sub 
Technical and Performance Data		
Supported wire sizes	AWG 12 to 20	AWG 8 to 14
Current rating	30 A	Up to 40 A
Contact Resistance (initial)	2,5 mW	*
Mechanical endurance	Up to 200 insertions	Up to 500 insertions
Body material	Copper Alloy	Copper Alloy
Retention spring material	Stainless Steel	*
Contact retention force (minimum)	100 N	*
Plating Availability		
Tin	Yes	-
Gold Flash (0,1 μm)	-	-
Gold	-	0,76 μm
Connector/Contact Capability		
Snap Together Rectangular, Slimline (TST) and Flame Retardant (TFR)	-	-
Ringlock (TR)	-	-
Neptune (TN)	Yes	-
Neptune Metal (TNM)	-	Yes
High Voltage (THV)	Yes	—
Page Number		
	67	67

* For details please consult the factory

Overview - T2P Contacts

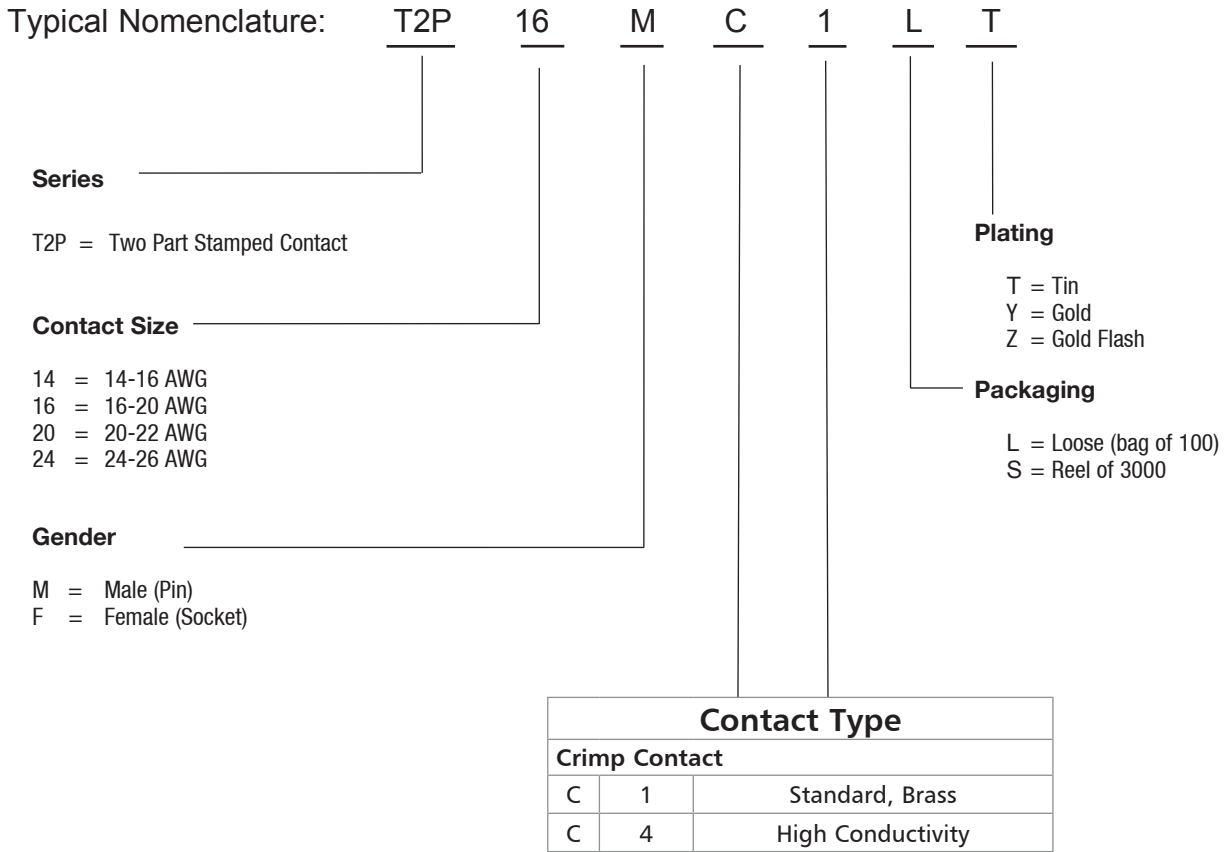

Note: This overview shows available options for formed (stamped) T2P contacts. The T2P nomenclature above appears as our description on ITT paperwork, etc, and this is for reference only. To order use the order codes on the following page.

Formed (Stamped) Crimp Contacts – Standard Brass Material

- 13 A current rating.
- Three plating styles available.
- Separate retention spring.
- Up to 200 mating cycles.
- Wide range of wire sizes.
- Full support tooling available, see pages 69-70.
- Two part design.



Size 14 to 16 AWG,
No Insulation Grip

Size 16 to 26 AWG,
Insulation Grip

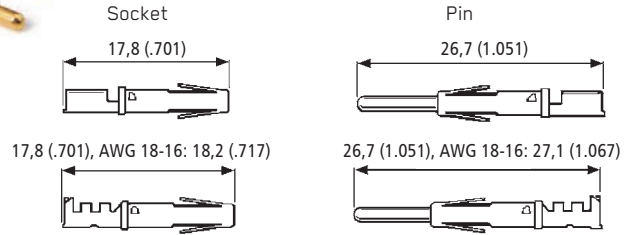

Wire Range mm ²	Wire Size	Contact	0,8 mm (32 m in.)						Insulation Diameter	Strip Length
			Tin Plating	Gold Flash	Gold Plating	Tin Plating	Gold Flash	Gold Plating		
0,14 - 0,25	26-24 AWG	Pin	192990-0020	192990-0080	192900-0448	192990-2510	192990-2650	192900-0406	0,89 (.035) - 1,58 (.062)	3,95 (.155)±0,25(.009)
0,14 - 0,25	26-24 AWG	Socket	192990-0030	192990-0090	192900-0452	192990-2550	192990-2690	192900-0410	0,89 (.035) - 1,58 (.062)	3,95 (.155)±0,25(.009)
0,32 - 0,50	22-20 AWG	Pin	192990-0040	192922-1460	192900-0447	192990-2500	192990-2640	192900-0405	1,17 (.046) - 2,08 (.081)	3,95 (.155)±0,25(.009)
0,32 - 0,50	22-20 AWG	Socket	192990-0050	192922-1470	192900-0451	192990-2540	192990-2680	192900-0409	1,17 (.046) - 2,08 (.081)	3,95 (.155)±0,25(.009)
0,75 - 1,50	18-16 AWG	Pin	192990-0060	192990-0100	192900-0446	192990-2490	192990-2630	192900-0404	2,00 (.078) - 2,70 (.106)	3,95 (.155)±0,25(.009)
0,75 - 1,50	18-16 AWG	Socket	192990-0070	192990-0110	192900-0450	192990-2530	192990-2670	192900-0408	2,00 (.078) - 2,70 (.106)	3,95 (.155)±0,25(.009)
1,50 - 2,50	16-14 AWG	Pin	192990-1240	192990-1220	192900-0445	192990-2480	192990-2620	192900-0403	Without insulation support	5,60 (.220)±0,25(.009)
1,50 - 2,50	16-14 AWG	Socket	192990-1250	192990-1230	192900-0449	192990-2520	192990-2660	192900-0407	Without insulation support	5,60 (.220)±0,25(.009)

Formed (Stamped) Crimp Contacts – High Conductivity Material

- 16 A current rating.
- Recommended for elevated temperatures.
- High conductivity copper alloy with tin plating.
- For use with standard crimp tooling, see pages 69-70.
- Two part design.
- Up to 200 mating cycles.



Size 14 to 16 AWG,
No Insulation Grip

Size 16 to 26 AWG,
Insulation Grip



Wire Range mm ²	Wire Size	Contact	Part Number		Insulation Diameter	Strip Length
			Pack (100)	Reeled (3000)		
0,14 - 0,25	26-24 AWG	Pin	192900-0122	192900-0120	0,89 (.035) - 1,58 (.062)	3,95 (.155)±0,25 (.009)
0,14 - 0,25	26-24 AWG	Socket	192900-0123	192900-0121	0,89 (.035) - 1,58 (.062)	3,95 (.155)±0,25 (.009)
0,32 - 0,50	22-20 AWG	Pin	192900-0126	192900-0124	1,17 (.046) - 2,08 (.081)	3,95 (.155)±0,25 (.009)
0,32 - 0,50	22-20 AWG	Socket	192900-0127	192900-0125	1,17 (.046) - 2,08 (.081)	3,95 (.155)±0,25 (.009)
0,75 - 1,50	18-16 AWG	Pin	192900-0002	192900-0000	2,00 (.078) - 2,70 (.106)	3,95 (.155)±0,25 (.009)
0,75 - 1,50	18-16 AWG	Socket	192900-0003	192900-0001	2,00 (.078) - 2,70 (.106)	3,95 (.155)±0,25 (.009)
1,50 - 2,50	16-14 AWG	Pin	192900-0005	192900-0004	Without insulation support	5,60 (.220)±0,25 (.009)
1,50 - 2,50	16-14 AWG	Socket	192900-0007	192900-0006	Without insulation support	5,60 (.220)±0,25 (.009)

Dimensions shown in mm (inch)
Specifications and dimensions subject to change

Overview - T3P Contacts

Typical Nomenclature:

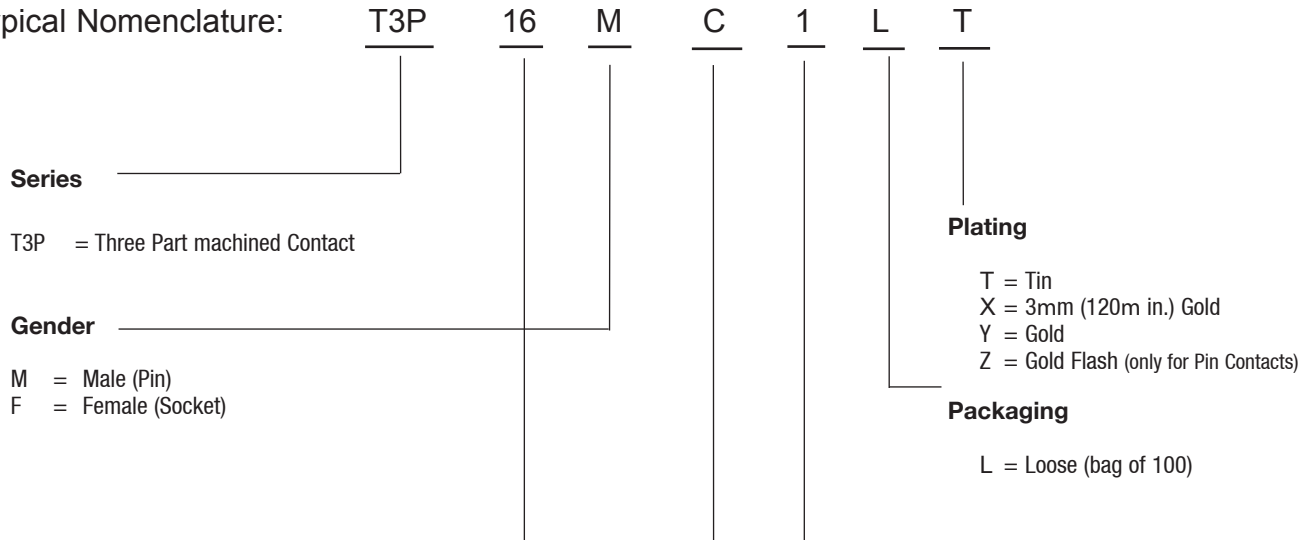

Type and Configuration Variant				
AWG Size	Gender	Crimp Contacts		
16		C	1	No insulation support, Black colorband
20		C	1	Insulation dia Ø1,6 (.062)-2,1 (.082), Green colorband
22		C	1	Insulation dia Ø1,6 (.062)-2,15 (.084), Red colorband
24		C	1	Insulation dia Ø1,05 (.041)-1,6 (.062), Blue colorband
26		C	1	Insulation dia Ø0,9 (.035)-1,4 (.055), Black colorband
Earth Contact				
16		E	1	Black colorband
20		E	1	Green colorband
Solder Cup Contact				
16		S	1	
Flow Solder Contact				
20		F	1	Ø0,72 (.028) short (female only)
20		F	3	Ø0,72 (.028) long (female only)
20		F	5	Ø0,73 (.029)
25		F	5	Ø1,52 (.060) (TN)

Note: This overview shows available options for formed (stamped) T3P contacts. The T3P nomenclature above appears as our description on ITT paperwork, etc, and this is for reference only. To order use the order codes on the following page.

Machined Crimp Contacts

- 13 A current rating.
- Separate contact and retention spring.
- Up to 500 mating cycles.
- Variety of plating options.
- Full support tooling available, see pages 69-70.



Size 16 AWG,
No Insulation Grip

Size 20 to 26 AWG,
Insulation Grip



Wire Range mm ²	Wire Size	Contact	Part Number (Pack of 100)			Insulation Diameter	Strip Length	Color Band
			Gold Plating(X)	Gold Plating(Y)	Tin Plating			
0,08 - 0,23	26 AWG	Pin	192991-0101	192991-0100	192991-0102	0,90 (.035) - 1,40 (.055)	5,08 (.200)±0,25 (.009)	Black
0,08 - 0,23	26 AWG	Socket	192991-0054	192991-0042	192991-0048	0,90 (.035) - 1,40 (.055)	5,08 (.200)±0,25 (.009)	Black
0,20 - 0,24	24 AWG	Pin	192991-0093	192991-0092	192991-0094	1,05 (.041) - 1,60 (.062)	5,08 (.200)±0,25 (.009)	Blue
0,20 - 0,24	24 AWG	Socket	192991-0055	192991-0043	192991-0049	1,05 (.041) - 1,60 (.062)	5,08 (.200)±0,25 (.009)	Blue
0,25 - 0,50	22 AWG	Pin	192991-0097	192991-0096	192991-0098	1,60 (.062) - 2,15 (.084)	5,08 (.200)±0,25 (.009)	Red
0,25 - 0,50	22 AWG	Socket	192991-0056	192991-0044	192991-0050	1,60 (.062) - 2,15 (.084)	5,08 (.200)±0,25 (.009)	Red
0,44 - 0,64	20 AWG	Pin	192991-0089	192991-0088	192991-0090	1,60 (.062) - 2,10 (.082)	5,08 (.200)±0,25 (.009)	Green
0,44 - 0,64	20 AWG	Socket	192991-0058	192991-0046	192991-0052	1,60 (.062) - 2,10 (.082)	5,08 (.200)±0,25 (.009)	Green
0,60 - 1,51	16 AWG	Pin	192991-0085	192991-0084	192991-0086	Without insulation support	7,11 (.279)±0,25 (.009)	Black
0,60 - 1,51	16 AWG	Socket	192991-0059	192991-0047	192991-0053	Without insulation support	7,11 (.279)±0,25 (.009)	Black
1,50 - 2,50	14 AWG	Pin	121587-0028	on request	on request	Without insulation support	7,11 (.279)±0,25 (.009)	White
1,50 - 2,50	14 AWG	Socket	121587-0039	on request	on request	Without insulation support	7,11 (.279)±0,25 (.009)	White

(Y) Gold plating Pin: 0,4 μm (16 μ in.). Gold plating Socket: 0,75 μm (30 μ in.).

(X) Gold plating Pin & Socket: 3 μm (120 μ in.).

Machined Earth (First Mate/Last Break) Contacts

- 13 A current rating.
- Separate contact and retention spring.
- Up to 500 mating cycles.
- Variety of plating options.
- Full support tooling available, see pages 69-70.



Size 16 AWG,
No Insulation Grip

Size 20 AWG,
Insulation Grip

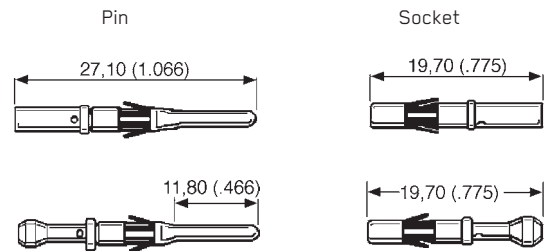

Wire Range mm ²	Wire Size	Contact	Part Number (Pack of 100)		Insulation Diameter	Strip Length	Color Band
			Gold Plating(Y)	Description			
0,44 - 0,64	20 AWG	Pin	192991-0164	T3P20ME1LY	1,60 (.062) - 2,10 (.082)	5,08 (.200)±0,25 (.009)	Green
0,44 - 0,64	20 AWG	Socket	192991-0207	T3P20FE1LY	1,60 (.062) - 2,10 (.082)	5,08 (.200)±0,25 (.009)	Green
0,60 - 1,51	16 AWG	Pin	192991-0160	T3P16ME1LY	Without insulation support	7,11 (.279)±0,25 (.009)	Black
0,60 - 1,51	16 AWG	Socket	192991-0208	T3P16FE1LY	Without insulation support	7,11 (.279)±0,25 (.009)	Black

(Y) Gold plating Pin: 0,4 μm (16 μ in.). Gold plating Socket: 0,75 μm (30 μ in.).
For Gold Flash Plating, please consult the factory.

Dimensions shown in mm (inch)
Specifications and dimensions subject to change

Solder Cup Contacts

- 13 A current rating.
- Ideal for prototypes and small volume applications.
- Fits into all Trident connectors.
- Simple solder, then insert.



Description	Part Number	
	Tin Plating	Gold Plating (Y)
Socket	192900-0634	192900-0635
Pin	192900-0632	192900-0633



(Y) Gold plating 0,4 μ m (16 μ in.)

Flow Solder (PCB) Contacts

- 13 A current rating.
- Available in different lengths depending on connector.
- 30 A power version available.



Connector Series	Type	Part Number (Pack of 100)				A ±1,00 (.039)	ØB ±0,06 (.002)
		Tin Plating	Gold Flash Plating				
Ringlock Standard Receptacle	Socket	***	192991-0524		33,6 (1.323)	0,72 (.028)	
Ringlock Standard Receptacle	Socket	***	192991-0066		26,5 (1.043)	0,72 (.028)	
Neptune	Pin	192900-0465	192900-0356		40,6 (1.598)	0,73 (.029)	
Neptune Power**	Pin	192991-0617	192991-0618		40,6 (1.598)	1,52 (.060)	

** Note: Appearance differs slightly from the picture.
 *** For details please consult the factory

Nominal lengths (x) of Flow Solder Contacts out of the connector*

Ringlock Standard Receptacle

Shell Size	192991-0066	192991-0524
10	4,5 (.177)	11,6 (.456)
12	2,7 (.106)	9,8 (.386)
14	4,5 (.177)	11,6 (.456)
16	2,7 (.106)	9,8 (.386)
18	2,7 (.106)	9,8 (.386)
20	3,0 (.118)	10,1 (.398)
22	2,0 (.079)	9,1 (.358)
24	1,2 (.047)	8,3 (.327)

Ringlock Reversed Receptacle

Shell Size	192991-0119 192991-0122
10	4,7 (.177)
12	4,7 (.177)
14	4,7 (.177)
16	4,7 (.177)
18	4,7 (.177)
20	4,6 (.181)
22	4,6 (.181)
24	4,6 (.181)



* For other connector series please consult the factory



Dimensions shown in mm (inch)
 Specifications and dimensions subject to change

APK
Power Contacts

- 30 A current rating.

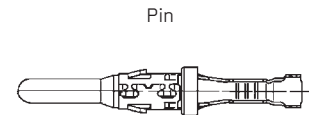
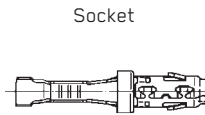

Wire Range mm ²	Wire Size	Contact	Description*	Part Number		Insulation Diameter	Strip Length
				Loose (100) Tin Plated	Reeled (3000) Tin Plated		
0,50 - 1,00	20-18 AWG	Pin	APK-PB25A10	031-8717-020	121668-0000	1,40 (.055) - 2,00 (.078)	5,00 (.196)±0,25 (.009)
0,50 - 1,00	20-18 AWG	Socket	APK-SB25A10	031-8717-120	121668-0100	1,40 (.055) - 2,00 (.078)	5,00 (.196)±0,25 (.009)
1,50 - 2,50	16-14 AWG	Pin	APK-PB25A25	031-8717-021	121668-0001	2,00 (.078) - 2,90 (.114)	5,00 (.196)±0,25 (.009)
1,50 - 2,50	16-14 AWG	Socket	APK-SB25A25	031-8717-121	121668-0101	2,00 (.078) - 2,90 (.114)	5,00 (.196)±0,25 (.009)
2,50 - 4,00	14-12 AWG	Pin	APK-PB25A40	031-8717-022	121668-0002	2,90 (.114) - 3,60 (.141)	5,00 (.196)±0,25 (.009)
2,50 - 4,00	14-12 AWG	Socket	APK-SB25A40	031-8717-122	121668-0102	2,90 (.114) - 3,60 (.141)	5,00 (.196)±0,25 (.009)

* Referring to reeled contacts

D Subminiature Loose Contacts, Size 8- High Power-Crimp

Plug

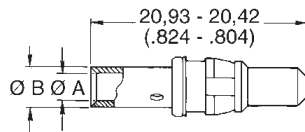

Recommended Wire Trim Length



Part Number (30 μin) 0,76μm Gold over Copper	A	B	Current	Wire Size
			Rating A	AWG
DM130338	4,60 (.181)	5,84 (.230)	40 A	8 AWG
DM130339	2,54 (.100)	5,54 (.218)	20 A	12 AWG

Receptacle

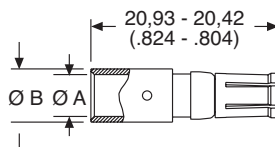

Recommended Wire Trim Length

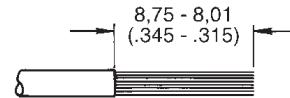

Part Number (30 μin) 0,76μm Gold over Copper	A	B	Current	Wire Size
			Rating A	AWG
DM130341	4,60 (.181)	5,84 (.230)	40 A	8 AWG
DM130342	2,54 (.100)	5,54 (.218)	20 A	12 AWG

Accessories



Description	Part Number	Pack Size
Discriminating (Keying) Pin, Signal Contacts	192990-0000	Bulk Pack (25)
Discriminating (Keying) Pin, Power Contacts	192900-0189	Bulk Pack (25)
Discriminating (Keying) Cap, Pin Contacts	192990-0010	Bulk Pack (100)
Discriminating (Keying) Peg, Socket Contacts	192990-7650	Bulk Pack (100)

Discriminating (Keying) Pins and Caps

Discriminating (Keying) Pins are used to prevent cross-mating of similar connectors. These pins are used in place of a pin contact. The corresponding socket cavity must be left open. If a socket contact is present, the discriminating pin will prevent mating. There are two types of discriminating pins. Board Mount PCB connectors have caps and pegs. All other connectors have signal or power pins.

Hand Tools
for Formed (Stamped) contacts

Ratcheted Hand Tool



A range of single action, factory calibrated tools are available to support the stamped contacts and 30 A power contacts.

Signal Contact	Power Contact	Part Number
14-16 AWG	N/A	121586-5238
16-18 AWG	N/A	121586-5237
20-22, 24-26 AWG	N/A	121586-5236
N/A	12-14, 14-16, 18-20 AWG	121586-5241

Hand Tool
for Machined Contacts



This is a ratcheted, four indent crimptool that is fully adjustable. They crimp all sizes of machined contacts.

Description	Hand Tool Part Number	Locator
Machined Crimp*	995-0001-585	192990-7600 (Calibrated) ¹

¹Nomenclature: TH-Trident

* M22520-1-01

Extraction Tools



Contacts can readily be removed from the housings using an extraction tool. The tool is placed over the contact and the sleeve rotated slightly as it is pushed home to release the spring. Light pressure on the knob then ejects the contact from the rear of the housing.

	Part Number
For Signal Contact	192922-1450
For Power Contact	192900-0176



	Part Number
For Power Contact	121086-3278



Wiring Assist Tool

These wiring needles are available as a wiring aid for high density layouts to ease insertion of individual contacts.

Description	Part Number
For Pin Contact	192900-0605
For Socket Contact	192900-0606



**Mini Applicators
(for Stamped Contacts)**

Mini Applicators are interchangeable modules that will fit into many standard crimping machines. They are available for all sizes of stamped signal and power contacts.

AWG Size	Contact Description	Mecal Part Number
14-16	Trident Signal	121586-5240
16-18	Trident Signal	121586-5217
20-26	Trident Signal	121586-5239
12-14	Trident 30 A Power	*
14-16	Trident 30 A Power	*
18-20	Trident 30 A Power	*

* For details please consult the factory



**Testing Gauge
(for Stamped Contacts)**

The testing gauge will be helpful to check whether a crimp is ok or not. The contact should be inserted into the test fixture without scratching the test hole (diameter 3.3 mm).

Description	Part Number
Testing Gauge	317-8675-133



**Pneumatic Table Crimp Tool
(for Machined Contacts)**

This Hand Crimp Tool fully meets the requirements of specification MIL-C-22520. The tool produces eight-indent crimp terminations of excellent quality. Together with the bench mount BM-2 and the foot pedal WA-10 it becomes an installed tool facilitating the work: The Hands of the operator are free to insert the contact and the wire and to remove the terminated contact.

Nomenclature	Description	Part Number	AWG
WA27F-CE	Pneumatic Crimp Tool	121586-5067	12-20
WA22F-CE	Pneumatic Crimp Tool	121586-5070	20-32
BM-2	Bench Mount	121586-5068	
WA10	Foot Pedal	121586-5069	

Crimping Instructions – Formed (Stamped) Crimp Contacts

Assembly Instructions:

1. Strip wires to length. For wire strip lengths, see page 63.
2. Open the hand tool and place the contact in the chosen die, ensuring that the locating plate is positioned between the collar and crimp saddle. Then squeeze tool gently to hold the contact in place.
3. Insert the wire.
4. Cycle the tool.
5. Remove the wire and inspect the crimp. The strands should be visible at both ends of the crimp. There should be no loose strands (see Figures 1-3). The contact should be co-linear with the wire (see Figure 4). Bent contacts are unacceptable (see Figure 5).

Figure 1 - Correct



Figure 2 - Unacceptable



Figure 3 - Unacceptable



Figure 4 - Correct



Figure 5 - Unacceptable



Crimping Instructions – Machined Crimp Contacts

Assembly Instructions:

1. Strip wires to length. For wire strip lengths, see page 65.
2. Attach the correct locator (turret) to the hand tool.

Contact Type	Locator Color
Pin	Blue
Socket	Green
Earthing	Black

3. Adjust the dial for the wire gauge.
4. Place the contact into the locator and insert the wire into the contact as indicated on the locator (turret) label.

5. Cycle the tool.
6. Remove and inspect the contact. Strands should be visible through the inspection window (see Figure 6). There should be no loose strands (see Figure 7).

Figure 6 - Correct



Figure 7 - Unacceptable



Notes:

- Wire Insulation.
- Wire Strands.
- Contact.
- Inspection Window. Strands must be visible.

Dimensions shown in mm (inch)
Specifications and dimensions subject to change

Contact Insertion

No insertion tool is required. Trident contacts are inserted from the rear of the connector and held in place by retention tines (cantilever springs). These tines compress during insertion. They expand once contact is in place and prevent the contact from backing out.

Proper Insertion of Trident Contact



Contact Retention Forces

- Minimum retention force of the contact to the insulator.

Contact	Newton(s)
Signal Contacts (Formed Crimp, Machined Crimp, Solder Cup, Flow Solder)	67
30 A Power Contacts	100

Note: Newton is a metric unit of force. One pound = 4.45 Newtons

Trident Assembly Instructions

(For Neptune and TNM Assembly, see page 73)

Assembly instructions:

1. Grasp the crimped or soldered contact just behind where the wire enters the contact.
2. Push the contact into the connector cavity until it locks into place.
3. Pull on the wire slightly to verify that the contact is secure.
4. Inspect the mating face of the connector. The contacts should extend the same distance into the connector.

Contact Insertion - Slimline



Contact Insertion - Ringlock



Neptune and TNM Assembly Instructions

Contact Insertion For Neptune and TNM Connectors

(For Trident Assembly, see page 72)

Neptune and TNM connectors feature membrane seals. These seals have a thin membrane that seals unused contact cavities. No sealing plugs are required for unused cavities. Neptune connectors do not require insertion tools. Cannon offers stitching tools as an optional assembly aid for high volume usage. Many customers find that stitching tools reduce the assembly time.

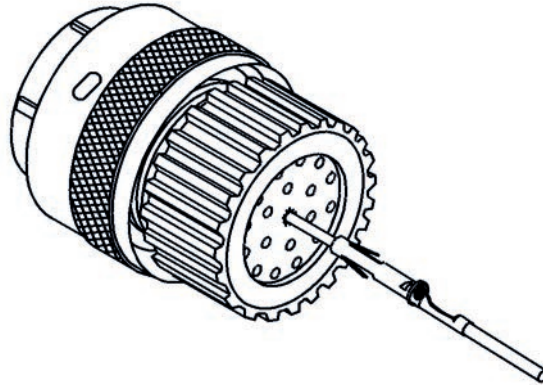

Assembly Instructions:

1. On Neptune and TNM connectors do not remove the Securing Nut holding the Wire Seal in place, unless an accessory such as Metal Endbell, Conduit Adapter, HC or SR Clamp assembly is to be used in its place. Then remove the Securing Nut (to be replaced by the accessory), make sure the tab on the Seal is positioned in the receiving slot in the connector, fit the accessory over the cables/wires and proceed as follows.
2. Grasp the crimped or soldered contact just behind where the wire enters the contact. If using a stitching tool, insert the contact into the rear of the tool.
3. Push the contact through the membrane seal into the insulator. Continue to push until the contact locks into place. If using a stitching tool, first insert the tool into the required contact position in the seal and examine the mating face to confirm that the correct contact cavity has been entered, if not, this can be corrected by partially removing the tool and engaging the correct position. Then fit the contact to the stitching tool and push the CONTACT through until it locks into place; remove the stitching tool.
4. Pull on the wire slightly to verify that the contact is secure.
5. Inspect the mating face of the connector. The contacts should extend the same distance into the connector.
6. Secure the nut, or other accessory, to hold the membrane seal in place.

IMPORTANT NOTE: The stitching tool is not designed to pull the contact through; it is intended to ease the insertion process with high density connectors.

On the high density connectors, such as 0-48, it is beneficial to start loading contacts on a center row first and filling adjacent rows fully each side, so progressively filling the connector from the center in a controlled manner.

Contact Extraction

Contacts may be removed with an extraction tool. The tool has an outer tube and an internal spring loaded plunger. The outer tube depresses the retention tines on the contact. The plunger then pushes the contact back out of the connector.

Extraction Instructions:

1. Grasp the extraction tool on the knurled portion of the outer tube. Do not push on the plunger knob yet.
 2. Insert the tube into the contact cavity from the mating surface. Push the tube fully into the cavity.
- IMPORTANT:** Verify that the depth indicating line on the tool is even with the mating face of the connector before depressing the plunger.
3. Depress the plunger. This should only require light pressure to eject the contact. The contact can now be removed from the back of the connector.
 4. Inspect the contact. Verify the tines are not damaged.

Contact Extraction



Extraction Tool



Endbell – Unsealed

Assembly Instructions:

1. Separate the body of the clamp, the two screws, and the clamping bar.
2. Slide the body over the wires or cable and screw onto the threads on the back of the connector. The backshell should be hand-tight. For Neptune and TNM connectors, the cable clamp will fit over the membrane seal and will hold it in place.
3. There are three clamp bars supplied. Select the appropriate one for the wire bundle and attach to the clamp body with the screws.



Endbell – Sealed

Assembly Instructions:

1. Separate the body of the clamp body, the two pressure rings, the sealing grommet, the clamp, and O-ring.
2. Slide the backshell components over the cable prior to crimping the contacts and assembling the connector. The farthest part from the connector is the clamp, followed by a pressure ring, then the grommet, then the other pressure ring, then the clamp body and then the O-ring.

Assembly Note: The grommet is a layered design. For large cables one or more of the interior sections can be removed. If the grommet resists sliding over the cable, lubricate with isopropyl alcohol.

3. Crimp and insert the contacts.
4. Slide the O-ring up and over the back of the connector.
5. Screw the clamp body onto the back of the connector. It should be hand-tight. For Neptune and TNM connectors, the cable clamp will fit over the membrane seal and will hold it in place.
6. Slide the pressure rings and grommet forward into the body.
7. Screw the cable clamp into the clamp body. The cable clamp will apply pressure to the grommet causing it to seal the backshell to the cable.
8. Screw down the clamp bar to secure the cable. Note that the bar is reversible, depending on the size of the cable.



Universal Endbell

Universal Endbell Assembly

The Universal Endbell is suitable to accept shielded and unshielded cable. This cable is sealed with a highly flexible seal and an additional sealing ring with a flexible plastic cable clamp serving as a strain relief. The Universal Endbell can be screwed onto plug and receptacle connectors. The O-ring and the cable sealing meet IP67.

Assembly Instructions:

1. Slide O-ring over the back of the connector body.
2. Slide the endbell components onto the cable in the following order:

- Clamp Nut
- Cable Grip1
- Cable Seal2
- Housing
- Grounding Ring
- Support Sleeve
- O-Ring

Note: 1. The compression fingers of the Cable Grip face toward the connector.

Note: 2. Isopropyl alcohol will lubricate the Cable Seal making it easier to slide over the cable.

3. Cut back the Outside Jacket to expose 25,40 (1.000) of Braid followed by 12,70 (.500) of Insulated Wires.
4. Terminate the wires and insert contacts per assembly instructions, see page 73.
5. Slide the Support Sleeve down until it reaches the back of the connector.
6. Pull the Braid over the Grounding Ring.
7. Slide the Grounding Ring down until it snaps onto the Support Sleeve. The Braid should be secured between the Support Sleeve and the Grounding Ring. Fold any excess shielding over the Grounding Ring.
8. Slide the Housing over the Grounding Ring and the Support Sleeve and screw it into the connector body. The recommended torque is 10 ± 1 Nm (88.50 in lbs).

9. Slide the Cable Seal and Cable Grip onto the Housing.

10. Tighten the Clamp Nut into the Housing. The recommended torque is 10 ± 1 Nm (88.50 in lbs).

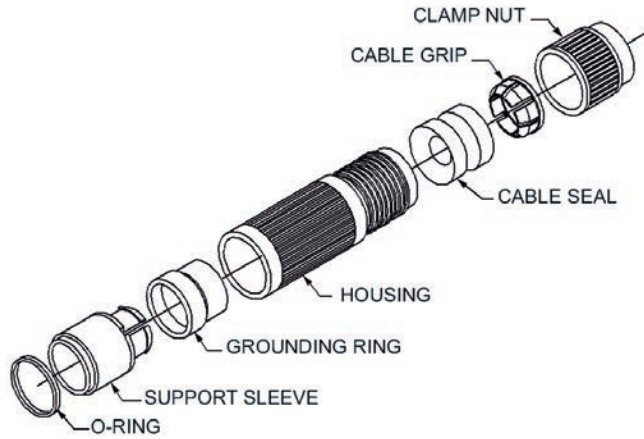

Wire Strip Length



Shell Size	Wire Strip Length		
	A	B	C
10	38,00 (1.500)	22,00 (.870)	*
12	38,00 (1.500)	22,00 (.870)	*
14	40,00 (1.600)	24,00 (.950)	*
16	40,00 (1.600)	24,00 (.950)	*

* Strip length will vary based on the contact selected, see page 64-65.

Shielded Endbell for Larger Cable Sizes

This Endbell is an alternative to the Universal Endbell for use with larger diameter cables. The outer body is sealed to the connector with an O-ring and the rear cable clamp also incorporates sealing rings for a complete sealed termination. The cable braid is terminated between metal cones. A rear cable clamp provides mechanical strain relief in addition to the clamping and holding of the rear cable seal.

Assembly Instructions:

1. Assemble all parts onto the cable as shown (Figure 1). Strip sheath of cable to dimensions shown in table below.

Size	A min.	Dimension Shell
10		22,30 (.877)
12		22,30 (.877)
14		26,20 (1.031)
16		28,10 (1.106)

2. Fold braid back over cable. Strip and terminate wires with selected contacts (Figure 2).

3. Assemble O-ring in groove of the shell after positioning coupling nut (Figure 3).

Figure 1



Figure 2



Wire Stripping Lengths

Contact Type	Wire Size	Wire Range mm2	Dimension B
Formed contact	24-16 AWG	0,08 - 1,50	3,95 ± 0,25 (.155 ± .009)
	14 AWG	1,50 - 2,50	5,60 ± 0,25 (.220 ± .009)
Machined contact	26-20 AWG	0,08 - 0,64	5,08 ± 0,25 (.200 ± .009)
	16 AWG	0,60 - 1,51	7,11 ± 0,25 (.279 ± .009)

Figure 3



Cable Sizes

Shell Size	Endbell Part Number	Cable Outer Sheath Diameter	
		Maximum	Minimum
10	192993-0091	10,00 (.393)	5,00 (.196)
12	192993-0092	12,00 (.472)	6,00 (.236)
14	192993-0093	14,00 (.551)	7,00 (.279)
16	192993-0094	16,00 (.629)	8,00 (.314)

Shielded Endbell for Larger Cable Sizes

(continued from page 77)

4. Fold braid forward as shown and trim to length (Figure 4).

5. Slide on clamp ring in position shown (Figure 5).

6. Screw clamp body onto the connector using a strap wrench (Figure 6). Tighten to the recommended torque values in table below.

Shell Size	Clamp body Torque max.
10	4 Nm
12	6 Nm
14	10 Nm
16	10 Nm

7. Push metal washers and rubber washer into rear of clamp body. Then screw compression nut to compress rubber washer. Avoid overtightening as this may twist the cable. Finally tighten screws to provide the mechanical strain relief (Figure 7).

8. Assembled connector (Figure 8).

Figure 4



Figure 5



Figure 6



Figure 7



Figure 8



Chart 1 International Protection (IP) ratings for IEC 529

First digit of IP Number – Ingress of foreign objects			Second digit of IP Number – Ingress of water								
			IP 0	IP 1	IP 2	IP 3	IP 4	IP 5	IP 6	IP 7	IP 8
	Meaning for the protection of equipment against ingress of solid foreign objects	Meaning for the protection of persons against access to hazardous parts with	non-protected	Protected against vertically falling water drops	Protected against vertically falling water drops when device is tilted up to 15°	Water sprayed an angle up to 60° on either side of the vertical shall have no harmful effects	Water splashed from any direction shall have no harmful effects	Water projected in jets from any direction shall have no harmful effects	Water projected in powerful jets from any direction shall have no harmful effects	Protected against temporary immersion	Protected against continuous immersion
IP 0	non-protected	non-protected	IP 00								
IP 1	Protected against solid foreign objects larger in diameter than 50 mm (1.97 in)	Protected against access to hazardous parts with the back of the hand	IP 10	IP 11	IP 12						
IP 2	Protected against solid foreign objects larger in diameter than 12.5 mm (.49 in)	Protected against access to hazardous parts with a finger	IP 20	IP 21	IP 22	IP 23					
IP 3	Protected against solid foreign objects larger in diameter than 2.5 mm (.10 in.)	Protected against access to hazardous parts with a tool larger in diameter than 2.5 mm (.10 in.)	IP 30	IP 31	IP 32	IP 33	IP 34				
IP 4	Protected against solid foreign objects larger in diameter than 1.0 mm (.04 in.)	Protected against access to hazardous parts with a wire larger in diameter than 1.0 mm (.04 in.)	IP 40	IP 41	IP 42	IP 43	IP 44				
IP 5	Ingress of dust is not totally prevented, but dust shall not penetrate in a quantity to interfere with satisfactory operation of the apparatus or to impair safety	Protected against access to hazardous parts with a wire larger in diameter than 1.0 mm (.04 in.)					IP 54	IP 55			
IP 6	No ingress of dust	Protected against access to hazardous parts with a wire larger in diameter than 1.0 mm (.04 in.)							IP 66	IP 67	IP 68

Dimensions shown in mm (inch)
 Specifications and dimensions subject to change

Chart 2 NEMA / IP Cross Reference

IEC 529 Protection Ratings	NEMA Ratings									
	1	2	3	3R	4	4X	5	6	12	13
IP 00										
IP 10	↓									
IP 11		↓								
IP 20										
IP 21										
IP 22										
IP 23										
IP 30										
IP 31										
IP 32				↓						
IP 33										
IP 40										
IP 41										
IP 42										
IP 43										
IP 50										
IP 51							↓			
IP 52										
IP 53										
IP 54									↓	↓
IP 55										
IP 56										
IP 60										
IP 61										
IP 62										
IP 63			↓							
IP 64										
IP 65										
IP 66										
IP 67					↓	↓				
IP 68								↓		

The chart above provides a cross-reference from NEMA to International Protection (IP) Ratings. This cross-reference is an approximation based on the most current information available. It is not sanctioned by NEMA, IEC, or any other regulatory body. This chart should be used only as a guideline.

GLOSSARY OF TERMS

In every job speciality there are certain words and phrases used by “insiders” which after a time become almost a language unique to that speciality. Trident technology is a typical example of that condition.

This page provides some explanations, in an attempt to clarify some of the terms that are commonly used by engineers and sales staff at Cannon.

The list is not comprehensive, but highlights many of the expressions commonly used. Should you have any comments or additions please contact us. Feedback will be appreciated.

ADAPTER – A device used to modify the accessory threading on the rear of the connector. Typical adapters are used to attach conduit, heat shrink, overmolds, or tubing to the connectors. They are generally used in place of a cable clamp.

AWG – American Wire Gauge. A method of specifying wire diameter. The higher the number, the smaller the diameter (a size 16 AWG wire has a larger diameter than a size 22 AWG).

BAYONET COUPLING – A quick coupling mechanism for mechanically mating and unmating connector halves. The plug half has a coupling nut with internal ramps and the receptacle has three “bayonet” pins. The two halves are mated and unmated by rotating the coupling nut. The two halves are mated and unmated by rotating the coupling nut.

BACKSHELL – See ENDBELL.

BODY – The main portion of the connector made of the shell, insulator, and contacts.

CABLE CLAMP – A rear connector clamping accessory which tightens over a cable or wire bundle to provide strain relief to the cable. The cable clamp may be part of a more elaborate endbell or it may be used alone. Some cable clamps also provide cable jacket sealing using a resilient gland, others provide only strain relief.

CABLE SEAL – An endbell or cable clamp that is used to seal a round jacketed cable as it enters the rear of the connector.

CONTACT – The conductive element in a connector which makes the actual connection between the wire and the mating connector for the purpose of transferring electrical energy. Ideally the contact should add nothing to the circuit. In the real world, however, contacts typically have a small CONTACT RESISTANCE and associated potential drop. Contacts come in many styles such as solder, crimp, printed circuit (PC), to name just those found in this catalog. Also see SOLDER CONTACT, CRIMP CONTACT, STAMPED AND FORMED CONTACT, PIN CONTACT, and SOCKET CONTACT.

CONTACT ALIGNMENT – The overall play that a contact has in the insulator cavity to allow the mating contacts to self align. Also called contact float.

CONTACT ARRANGEMENT – See LAYOUT.

CONTACT CAVITY – A defined hole in the connector insulator into which the contacts fit. The cavities are generally marked with a unique designation or number for ease of identification.

CONTACT RESISTANCE – The maximum amount of resistance which a contact introduces into the connection when carrying a specified current (usually stated in milliohms). When not stated, values are typically given for “Initial” or new contacts. Most specifications also limit the maximum resistance during or after each of a series of extreme tests, such as “Contact Resistance After Corrosion Test”. These figures are typically slightly higher than “Initial”.

CONTACT RETENTION – The maximum allowable axial load which can be applied to a contact from either direction without it being dislodged from the insulator. Usually stated in Newtons or pounds of force (4.45 = 1 lbf).

CONTACT SEPARATION FORCE – The force required to separate a pair of mated contacts. Usually stated in grams or ounces.

CONTACT SIZE – The size of the engaging pin and socket contacts in AWG size or metric diameter of the pin.

CONTACT SPACING – The distance between two centers of adjacent contacts.

COUPLING NUT (Also known as LOCKING RING) – The rotating ring on plug style connectors which mechanically locks the two connec-

tor halves together.

CRIMP CONTACT – A contact which is terminated to a wire by means of mechanical deformation of the receiving area by means of an appropriate tool.

CSA – Abbreviation for Canadian Standards Association.

CURRENT RATING – The maximum current that a particular wire, contact, or connector can accommodate. NOTE: When several wires are used in a single connector or elevated temperature or altitude is involved, derating curves must be applied to these ratings.

DERATING CURVE – A graph of the change in power handling capability of a connector as a function of ambient temperature or altitude. Typically the graphed function is curved, hence the name.

DISCRIMINATION – A method of ensuring that two similar size connectors cannot be mated. This may be achieved by inclusion of discriminating pins, which enter an empty contact cavity, or by other mechanical means.

DISCRIMINATING PINS – See KEYING.

ENDBELL (also known as BACKSHELL) – The outer rear end of the connector, which is attached by means of internal threads or screws. It adapts the connector to its wire connections in a variety of ways. Typical endbells might have cable clamps to secure a wire bundle, ridges for heat shrink tubing, pipe threads, or shield termination mechanisms.

EXTRACTION TOOL – A device used to remove a contact from a connector insulator. The extraction tool is inserted into the mating face of the insulator and the contact comes out the rear, or wire side, of the connector.

FIRST-MAKE LAST-BREAK CONTACT – A contact which is longer than a standard contact or which sits in the insulator in such a way that it mates with the opposing connector half before any of the other contacts. Used to ensure that a ground connection between the connector halves mates before any of the other contacts.

FLANGED RECEPTACLE – The shell of this connector has a square flange with mounting holes at each corner. Mounting holes are usually clearance holes, but may

be threaded. Receptacle flanges may be mounted in front or at the rear of the panel.

FLASH PLATING. – As commonly used in connector terminology, flash refers to extremely thin platings of metal. A flash plating is the minimum thickness required to ensure complete surface coverage. It is typically used on contacts that will have only occasional mating and unmating.

IEC – Abbreviation for the International Electrotechnical Commission. An international organization, which develops standards exclusively for electrical engineering. CENELEC is the equivalent organization at the European level.

INSULATOR – The insulating element into which the contacts are mounted in a connector.

IP67 – One classification from a rating system used in Europe covering the environmental sealing capability of an enclosure. The system uses two digits, the first digit relates to the degrees of protection the connector has from dirt and dust under the conditions defined in the specification. The second digit relates to the degrees of protection it has against moisture. The degree of protection against dirt ranges from 1 (no protection), to 6 (dust tight). Moisture sealing in the specification ranges from 1 (no protection), to 8 (protected against continuous submersion). The classification IP67 states that the connector is “dust-tight” (6), allowing no ingress of dust what-so-ever, and “protected against the effects of immersion” (7), the ingress of water in harmful quantity shall not be possible when the connector is immersed in water under defined conditions of pressure and time.

JAM NUT RECEPTACLE – A receptacle con-

necter that is mounted from the rear side of the panel and is held in place by a large hex nut (jam nut).

KEYING – A method of differentiating a connector if more than one connector with the same sex and layout is to be used in a system. The key is a pin which can be located in a contact cavity or slot. The key will prevent a connector without a matching orifice from mating.

LAYOUT – The number, size, and geometric arrangement of the contacts in a connector. When a connector is said to have a certain “layout” it refers to a specific contact configuration. For example, the Snap Together Connector series has a page of drawings showing the arrangement of the contacts in the insulator. Each of these arrangements can be referred to as a layout.

LOCKING RING – See **COUPLING NUT**.

PIN CONTACT – The contact that has a long shaft at the engagement end which enters the socket contact.

PLUG – The male portion of the connector pair usually employing a coupling nut to secure it to the receptacle half. A Plug may have either pin or socket contacts.

POLARIZATION – Polarization ensures that connector halves engage in such a way that the identified contact cavities always engage each other, A to A etc. The connector is polarized.

POLARIZING PIN – See **KEYING**.

REAR MOUNTING – A receptacle that mounts through the panel from the rear, with its mounting flange inside the equipment. Typically, rear mount receptacles are slightly longer than front mount types to allow for the thickness of

the panel. Flange mount receptacles usually come in front and rear mount versions. All Jam nut receptacles are rear mount.

RECEPTACLE – The connector which mates with the plug. The receptacle has threads, pins or ramps that engage the coupling nut on the plug, locking the two halves together. A receptacle may have either pin or socket contacts.

SHELL – The outside case of a connector into which the insulator and contacts are situated.

SHELL SIZE – A standard system developed for military circular connectors for indicating the diameter of the shell. The system is based upon 1/16” increments, that is, a size 16 shell is one inch in diameter.

SOCKET CONTACT – The contact that has an opening at the engagement end to accept the pin contact.

SOLDER CONTACT – A contact that is terminated to the wire or printed circuit with solder. The alternative is crimp contacts to which a wire is attached by crimping.

SOLDER CUP – The end of a **SOLDER CONTACT** designed to accept a wire, which will then be soldered to the contact.

STAMPED AND FORMED CONTACT – Contacts made by stamping and forming a sheet of metal rather than by machining metal stock.

UL – Abbreviation for Underwriter’s Laboratories, a corporation supported by a group of underwriters for the purpose of establishing safety standards covering certain types of equipment and components in the United States. Product Safety Information

Part Number	Page	Part Number	Page	Part Number	Page	Part Number	Page	Part Number	Page
031-8717-020	67	192900-0035	38	192900-0392	37	192900-0558	40	192926-0500	29
031-8717-021	67	192900-0036	37	192900-0395	42	192900-0560	40	192926-0510	29
031-8717-022	67	192900-0038	38	192900-0396	42	192900-0561	36	192926-0520	29
031-8717-120	67	192900-0039	37	192900-0402	47	192900-0562	40	192926-0530	29
031-8717-121	67	192900-0051	36	192900-0403	63	192900-0564	40	192926-0540	29
031-8717-122	67	192900-0052	40	192900-0404	63	192900-0565	47	192926-0550	29
075-8543-011	30	192900-0053	39	192900-0405	63	192900-0566	47	192943-4580	69
075-8543-012	30	192900-0054	39	192900-0406	63	192900-0567	47	192945-4380	68
075-8543-013	30	192900-0055	39	192900-0407	63	192900-0581	39	192945-4390	68
075-8543-014	30	192900-0056	39	192900-0408	63	192900-0582	41	192945-4530	68, 69
075-8543-015	30	192900-0057	39	192900-0409	63	192900-0583	42	192945-4930	68, 69
075-8543-016	30	192900-0064	41	192900-0410	63	192900-0586	42	192990-0000	56, 69
075-8543-017	30	192900-0066	42	192900-0411	12	192900-0632	66	192990-0010	63
075-8543-018	30	192900-0068	42	192900-0412	12	192900-0633	66	192990-0020	63
120090-0118	71	192900-0069	41	192900-0413	12	192900-0634	66	192990-0030	63
121086-3278	70	192900-0071	42	192900-0414	12	192900-0635	66	192990-0040	63
121586-5067	71	192900-0072	41	192900-0415	12	192900-0636	56	192990-0050	63
121586-5068	71	192900-0074	45	192900-0416	12	192900-0637	56	192990-0060	63
121586-5069	71	192900-0075	41	192900-0417	12	192900-0639	56	192990-0070	63
121586-5070	71	192900-0077	42	192900-0418	13	192900-0640	56	192990-0080	63
121586-5217	71	192900-0078	41	192900-0419	13	192900-0654	45	192990-0090	63
121586-5236	70	192900-0092	35	192900-0420	13	192900-0664	40	192990-0100	63
121586-5237	70	192900-0093	35	192900-0421	13	192900-0666	30	192990-0110	63
121586-5238	70	192900-0094	35	192900-0422	13	192900-0667	30	192990-0350	10
121586-5239	71	192900-0096	37	192900-0423	13	192900-0668	30	192990-0360	11
121586-5240	71	192900-0098	38	192900-0424	13	192900-0669	30	192990-0370	10
121586-5241	70	192900-0099	37	192900-0425	39	192900-0670	30	192990-0380	11
121587-0010	16	192900-0101	38	192900-0428	39	192900-0671	30	192990-0400	11
121587-0011	16	192900-0102	37	192900-0429	39	192900-0672	30	192990-0420	11
121587-0012	16	192900-0104	38	192900-0431	41	192900-0673	30	192990-0430	11
121587-0013	16	192900-0105	37	192900-0434	41	192900-0676	30	192990-0440	11
121587-0014	16	192900-0106	39	192900-0435	41	192900-0677	30	192990-0450	11
121587-0015	16	192900-0107	39	192900-0437	42	192900-0678	30	192990-0460	10
121587-0016	16	192900-0108	39	192900-0438	42	192900-0679	30	192990-0470	10
121587-0020	16	192900-0109	39	192900-0440	42	192900-0680	30	192990-0480	10
121587-0021	16	192900-0110	41	192900-0441	42	192900-0681	30	192990-0960	19
121587-0022	16	192900-0113	41	192900-0445	63	192900-0682	30	192990-0970	19
121587-0023	16	192900-0115	42	192900-0446	63	192900-0683	30	192990-0980	19
121587-0024	16	192900-0116	41	192900-0447	63	192900-0691	36	192990-0990	19
121587-0025	16	192900-0118	42	192900-0448	63	192900-0692	36	192990-1000	19
121587-0026	16	192900-0119	41	192900-0449	63	192900-0718	47	192990-1220	63
121587-0030	17	192900-0120	63	192900-0450	63	192922-1190	26	192990-1230	63
121587-0031	17	192900-0121	63	192900-0451	63	192922-1200	26	192990-1240	63
121587-0032	17	192900-0122	63	192900-0452	63	192922-1210	26	192990-1250	63
121587-0033	17	192900-0123	63	192900-0457	47	192922-1220	26	192990-1290	26
121587-0034	17	192900-0124	63	192900-0458	47	192922-1230	26	192990-1300	26
121587-0035	17	192900-0125	63	192900-0465	66	192922-1240	26	192990-1310	26
121587-0036	17	192900-0126	63	192900-0469	35	192922-1250	25	192990-1320	25
121587-0040	17	192900-0127	63	192900-0473	35	192922-1260	25	192990-1330	25
121587-0041	17	192900-0176	70	192900-0472	35	192922-1270	25	192990-1340	25
121587-0042	17	192900-0184	45	192900-0475	37	192922-1280	25	192990-1350	28
121587-0043	17	192900-0185	45	192900-0478	37	192922-1290	25	192990-1360	28
121587-0044	17	192900-0187	45	192900-0479	37	192922-1300	25	192990-1370	28
121587-0045	17	192900-0189	46, 69	192900-0481	38	192922-1310	31	192990-1380	27
121587-0046	17	192900-0226	45	192900-0484	38	192922-1320	31	192990-1390	27
121668-0000	71	192900-0236	39	192900-0485	35, 38	192922-1330	31	192990-1400	27
121668-0001	71	192900-0242	39	192900-0487	46	192922-1340	31	192990-1430	30
121668-0002	71	192900-0241	39	192900-0488	46	192922-1350	31	192990-1440	30
121668-0100	71	192900-0256	41	192900-0489	46	192922-1360	31	192990-1450	30
121668-0101	71	192900-0261	41	192900-0490	38	192922-1450	70	192990-1460	30
121668-0102	71	192900-0262	41	192900-0493	38	192922-1460	63	192990-1470	30
192900-0000	63	192900-0266	42	192900-0494	38	192922-1470	63	192990-1480	30
192900-0001	63	192900-0271	42	192900-0496	44, 56	192923-5920	10	192990-1490	30
192900-0002	63	192900-0286	44, 56	192900-0497	44, 56	192923-5930	10	192990-1500	30
192900-0003	63	192900-0303	35	192900-0498	44	192923-5940	10	192990-1510	31
192900-0004	63	192900-0308	37	192900-0507	35	192923-5950	10	192990-1520	31
192900-0005	63	192900-0313	38	192900-0508	38	192923-5960	10	192990-1530	31
192900-0006	63	192900-0318	35	192900-0509	37	192923-5970	10	192990-1540	31
192900-0007	63	192900-0319	35	192900-0510	35	192923-5980	10	192990-1550	31
192900-0012	35	192900-0323	37	192900-0511	38	192923-5990	10	192990-1560	31
192900-0013	35	192900-0324	37	192900-0512	37	192923-6000	10	192990-1570	31
192900-0014	35	192900-0328	38	192900-0537	36	192923-6010	11	192990-1580	31
192900-0015	35	192900-0329	38	192900-0538	36	192923-6020	11	192990-1590	31
192900-0016	35	192900-0343	44, 56	192900-0539	36	192923-6030	11	192990-1600	31
192900-0017	35	192900-0344	44	192900-0540	40	192923-6040	11	192990-1660	26
192900-0024	37	192900-0353	42	192900-0541	40	192923-6050	11	192990-1670	26
192900-0026	38	192900-0356	66	192900-0542	40	192926-0440	28	192990-1680	26
192900-0028	38	192900-0370	42	192900-0547	40	192926-0450	28	192990-1690	26
192900-0029	37	192900-0378	47	192900-0548	40	192926-0460	28	192990-1700	26
192900-0030	37	192900-0379	47	192900-0549	36	192926-0470	28	192990-1710	26
192900-0032	38	192900-0383	47	192900-0550	40	192926-0480	28	192990-1720	26
192900-0033	37	192900-0388	47	192900-0557	36	192926-0490	28	192990-1730	26

Dimensions shown in mm (inch)
 Specifications and dimensions subject to change



Part Number	Page	Part Number	Page	Part Number	Page	Part Number	Page	Part Number	Page
192990-1740	26	192991-0094	65	192993-0013	50	TFR04AH10	16	TN6G14-0012P1B	35
192990-1760	28	192991-0096	65	192993-0014	50	TFR04PA10	16	TN6G14-0012P1L	35
192990-1770	28	192991-0097	65	192993-0021	50	TFR04PH10	17	TN6G14-0012S1B	39
192990-1780	28	192991-0098	65	192993-0022	50	TFR04RA10	17	TN6G14-0012S1L	39
192990-1790	28	192991-0100	65	192993-0023	50	TFR06AH10	16	TN6G16-0019S1B	39
192990-1800	28	192991-0101	65	192993-0024	50	TFR06PA10	16	TN6G16-0019S1L	39
192990-1810	28	192991-0102	65	192993-0031	50	TFR06PH10	17	TN6G16-0019P1B	35
192990-1820	28	192991-0119	66	192993-0032	50	TFR06RA10	17	TN6G16-0019P1L	35
192990-1830	28	192991-0122	66	192993-0033	50	TFR12AH10	16	TN6G24-0048S1B	39
192990-1840	28	192991-0160	65	192993-0034	50	TFR12PA10	16	TN6G24-0048S1L	39
192990-2480	63	192991-0164	65	192993-0041	51	TFR12PH10	17	TN6G24-0048P1B	35
192990-2490	63	192991-0207	65	192993-0042	51	TFR12RA10	17	TN6G24-0048P1L	35
192990-2500	63	192991-0208	65	192993-0043	51	TFR24AH10	16	TN6G24-0420P1B	35
192990-2510	63	192991-0213	13	192993-0044	51	TFR24PA10	16	TN6G24-0420P1L	35
192990-2520	63	192991-0214	13	192993-0051	51	TFR24PH10	17	TN6G24-0420S1B	39
192990-2530	63	192991-0221	13	192993-0052	51	TFR24RA10	17	TN6G24-0420S1L	39
192990-2540	63	192991-0222	13	192993-0053	51	TFR36AH10	16	TN6G24-0428P1B	35
192990-2550	63	192991-0229	13	192993-0054	51	TFR36PA10	16	TN6G24-0428P1L	35
192990-2620	63	192991-0230	13	192993-0061	51	TFR36PH10	17	TN6G24-0428S1B	39
192990-2630	63	192991-0237	13	192993-0062	51	TFR36RA10	17	TN6G24-0428S1L	39
192990-2640	63	192991-0238	13	192993-0063	51	THV6U14-0400P1L-02	58	TN6G24-1219P1B	35
192990-2650	63	192991-0245	13	192993-0064	51	THV0U14-0400S1L-02	58	TN6G24-1219P1L	35
192990-2660	63	192991-0246	13	192993-0071	51	THV6U14-0400S1L-02	58	TN6G24-1219S1B	39
192990-2670	63	192991-0253	13	192993-0072	51	THV0U14-0400P1L-02	58	TN6G24-1219S1L	39
192990-2680	63	192991-0254	13	192993-0073	51	TN0G14-0012P1B	41	TN6L24-0048P1L	35
192990-2690	63	192991-0261	13	192993-0074	51	TN0G14-0012P1L	41	TN6L24-0048P1B	35
192990-3230	12	192991-0262	13	192993-0081	55	TN0G14-0012S1B	37	TN6L24-0048P2B	36
192990-3240	12	192991-0270	12	192993-0082	55	TN0G14-0012S1L	37	TN6L24-0048P2L	36
192990-3250	12	192991-0271	12	192993-0083	55	TN0G14-0012P1B	41	TN6L24-0048S1B	39
192990-3260	12	192991-0278	12	192993-0084	55	TN0G14-0012P1L	41	TN6L24-0048S1L	39
192990-3270	12	192991-0279	12	192993-0087	58	TN0G16-0019S1B	37	TN6L24-0048S2B	40
192990-3280	12	192991-0286	12	192993-0091	54, 77	TN0G16-0019S1L	37	TN6L24-0048S2L	40
192990-3290	12	192991-0287	12	192993-0092	54, 77	TN0G24-0048P1B	41	TN6S14-0012P1B	35
192990-3300	13	192991-0294	12	192993-0093	54, 77	TN0G24-0048P1L	41	TN6S14-0012P1L	35
192990-3310	13	192991-0295	12	192993-0094	54, 77	TN0G24-0048S1B	37	TN6S14-0012S1B	39
192990-3320	13	192991-0302	12	192993-0105	52	TN0G24-0048S1L	37	TN6S14-0012S1L	39
192990-3330	13	192991-0303	12	192993-0106	52	TN0G24-0420P1B	41	TN6S16-0019P1B	35
192990-3340	13	192991-0310	12	192993-0109	52	TN0G24-0420P1L	41	TN6S16-0019P1L	35
192990-3350	13	192991-0311	12	192993-0261	53	TN0G24-0420S1B	37	TN6S16-0019P2B	36
192990-3360	13	192991-0316	20	192993-0631	54	TN0G24-0420S1L	37	TN6S16-0019P2L	36
192990-7650	69	192991-0317	21	192993-0632	54	TN0G24-0428P1B	41	TN6S16-0019S1B	39
192990-9240	39	192991-0318	20	192993-0633	54	TN0G24-0428P1L	41	TN6S16-0019S1L	39
192990-9250	41	192991-0319	21	192993-0634	54	TN0G24-0428S1B	37	TN6S16-0019S2B	40
192990-9380	35	192991-0320	20	192993-0695	50	TN0G24-0428S1L	37	TN6S16-0019S2L	40
192990-9390	37	192991-0321	21	192993-0696	51	TN0G24-1219P1B	41	TN6S16-0213P1B	35
192990-9420	37	192991-0322	20	192993-0697	51	TN0G24-1219P1L	41	TN6S16-0213P1L	35
192990-9430	35	192991-0323	21	192993-0698	50	TN0G24-1219S1B	37	TN6S16-0213P2B	36
192990-9440	41	192991-0324	20	192993-0699	52	TN0G24-1219S1L	37	TN6S16-0213P2L	36
192990-9450	39	192991-0325	21	192993-0700	52	TN0L24-0048P1B	41	TN6S16-0213S1B	39
192990-9460	38	192991-0337	20	192993-0702	58	TN0L24-0048P1L	41	TN6S16-0213S1L	39
192990-9470	42	192991-0342	20	192993-0704	58	TN0L24-0048S1B	37	TN6S16-0213S2B	40
192990-9970	39	192991-0347	20	192993-0706	58	TN0L24-0048S1L	37	TN6S16-0213S2L	40
192990-9980	41	192991-0354	20	192993-0708	58	TN0S14-0012P1B	41	TN6S24-0048P1B	35
192991-0013	45	192991-0402	12	192993-2013	53	TN0S14-0012P1L	41	TN6S24-0048P1L	35
192991-0015	45	192991-0403	12	193800-0023	48	TN0S14-0012S1B	37	TN6S24-0048P2B	36
192991-0018	46	192991-0524	66	193800-0024	48	TN0S14-0012S1L	37	TN6S24-0048P2L	36
192991-0042	65	192991-0532	21	193800-0029	48	TN0S16-0019P1B	41	TN6S24-0048S1B	39
192991-0043	65	192991-0533	21	193800-0031	48	TN0S16-0019P1L	41	TN6S24-0048S1L	39
192991-0044	65	192991-0534	21	193877-5630	48	TN0S16-0019S1B	37	TN6S24-0048S2B	40
192991-0046	65	192991-0535	21	193877-5640	48	TN0S16-0019S1L	37	TN6S24-0048S2L	40
192991-0047	65	192991-0536	20	274-7613-000	70	TN0S16-0019P1B	41	TN6S24-0420P1B	35
192991-0048	65	192991-0538	21	317-8675-133	71	TN0S16-0213P1L	41	TN6S24-0420P1L	35
192991-0049	65	192991-0617	66	995-0001-584	70	TN0S16-0213S1B	37	TN6S24-0420P2B	36
192991-0050	65	192991-0618	66	995-0001-585	70	TN0S16-0213S1L	37	TN6S24-0420P2L	36
192991-0052	65	192991-0628	35	DM130338	67	TN0S24-0048P1B	41	TN6S24-0420S1B	39
192991-0053	65	192991-0640	37	DM130339	67	TN0S24-0048P1L	41	TN6S24-0420S1L	39
192991-0054	65	192991-0644	38	DM130341	67	TN0S24-0048S1B	37	TN6S24-0420S2B	40
192991-0055	65	192991-0648	39	DM130342	67	TN0S24-0048S1L	37	TN6S24-0420S2L	40
192991-0056	65	192991-0652	41	TC1FCLY	62	TN0S24-0048P1B	41	TN6S24-0428P1L	35
192991-0058	65	192991-0656	42	TC1MCLY	62	TN0S24-0420P1L	41	TN6S24-0428P2B	36
192991-0059	65	192991-0660	36	TC2FCLY	62	TN0S24-0420S2B	37	TN6S24-0428P2L	36
192991-0066	66	192991-0664	35	TC2MCLY	62	TN0S24-0420S1L	37	TN6S24-0428S1B	39
192991-0084	65	192991-0668	11	TFR02AH10	16	TN0S24-0428P1B	41	TN6S24-0428S1L	39
192991-0085	65	192991-0673	47	TFR02PA10	16	TN0S24-0428P1L	41	TN6S24-0428S2B	40
192991-0086	65	192993-0001	50	TFR02PH10	17	TN0S24-0428S1B	37	TN6S24-0428S2L	40
192991-0088	65	192993-0002	50	TFR02RA10	17	TN0S24-0428S1L	37	TN6S24-1219P1B	35
192991-0089	65	192993-0003	50	TFR03AH10	16	TN0S24-1219P1B	41	TN6S24-1219P1L	35
192991-0090	65	192993-0004	50	TFR03PA10	16	TN0S24-1219P1L	41	TN6S24-1219P2B	36
192991-0092	65	192993-0011	50	TFR03PH10	17	TN0S24-1219S1B	37		
192991-0093	65	192993-0012	50	TFR03RA10	17	TN0S24-1219S1L	37		



Part Number	Page	Part Number	Page	Part Number	Page	Part Number	Page	Part Number	Page
TN6S24-1219P2L	36	TN7S16-0019S1L	38	TNMOS10-0004P1L	51	TR1619RFH1N	26	TST04RB01Z	12
TN6S24-1219S1B	39	TN7S16-0213P1B01	42	TNMOS10-0004S1L	50	TR1619RFS1NB	26	TST04RB02T	13
TN6S24-1219S1L	39	TN7S16-0213P1L	42	TNMOS12-0008P1L	51	TR1619RMH1NB	28	TST04RB02Z	13
TN6S24-1219S2B	40	TN7S16-0213S1B01	38	TNMOS12-0008S1L	50	TR1619RMS1NB	28	TST04RB05T	12
TN6S24-1219S2L	40	TN7S16-0213S1L	38	TNMOS14-0012P1L	51	TR18AAD	30	TST04RB05Y	12
TN6S24-0420P2L	32	TN7S16-0213P1B01	42	TNMOS14-0012S1L	50	TR18AHC1N	31	TST04RB06T	13
TN6S24-0428P2L	32	TN7S24-0048P1L	42	TNMOS14-0304P1L	51	TR18ASR1N	31	TST04RB06Y	13
TN6U16-0213P1B	35	TN7S24-0048S1B01	38	TNMOS14-0304S1L	50	TR1807PFS1NB	27	TST04RD01T	20
TN6U16-0213P2B	36	TN7S24-0048S1L	38	TNMOS16-0019P1L	51	TR1807PMS1NB	25	TST04RD01Y	20
TN6U16-0213P1L	35	TN7S24-0420P1B01	42	TNMOS16-0019S1L	50	TR1807RFH1NB	26	TST04RE01T	21
TN6U16-0213P2L	36	TN7S24-0420P1L	42	TNMOSU10-0004P1L	51	TR1807RFS1NB	26	TST04RE01Y	21
TN6U16-0213S1B	39	TN7S24-0420S1B01	38	TNMOSU10-0004S1L	50	TR1807RMHNB	28	TST06AH00	10
TN6U16-0213S1L	39	TN7S24-0420S1L	38	TNMOSU12-0008P1L	51	TR1807RMS1NB	28	TST06AS00	11
TN6U16-0213S2B	40	TN7S24-0428P1B01	42	TNMOSU12-0008S1L	50	TR1823PFS1NB	27	TST06PA00	10
TN6U16-0213S2L	40	TN7S24-0428P1L	42	TNMOSU14-0012P1L	51	TR1823PMS1NB	25	TST06PF00	19
TN6U24-0420P1B	35	TN7S24-0428S1B01	38	TNMOSU14-0012S1L	50	TR1823RFH1NB	26	TST06RA00	11
TN6U24-0420P2B	36	TN7S24-0428S1L	38	TNMOSU16-0019P1L	51	TR1823RFS1NB	26	TST06RB01T	12
TN6U24-0420P1L	35	TN7S24-1219P1B01	42	TNMOSU16-0019S1L	50	TR1823RMH1NB	28	TST06RB01Z	12
TN6U24-0420P2L	36	TN7S24-1219P1L	42	TNM6S10-0004P1L	50	TR1823RMS1NB	28	TST06RB02T	13
TN6U24-0420S1B	39	TN7S24-1219S1B01	38	TNM6S10-0004S1L	51	TR20AAD	30	TST06RB02Z	13
TN6U24-0420S1L	37	TN7S24-1219S1L	38	TNM6S12-0008P1L	50	TR20AHC1N	31	TST06RB05T	12
TN6U24-0420S2B	40	TN7U16-0213S1B01	38	TNM6S12-0008S1L	51	TR20ASR1N	31	TST06RB05Y	12
TN6U24-0420S2L	40	TN7U160213S1L	38	TNM6S14-0012P1L	50	TR2028PFS1NB	27	TST06RB06T	13
TN6U24-0428P1B	35	TN7U24-0420S1B01	38	TNM6S14-0012S1L	51	TR2028PMS1NB	25	TST06RB06Y	13
TN6U24-0428P2B	36	TN7U24-0420S1L	38	TNM6S14-0304P1L	50	TR2028RFH1NB	26	TST06RD01T	20
TN6U24-0428P1L	35	TN7U24-0428P1B01	42	TNM6S14-0304S1L	51	TR2028RFS1NB	26	TST06RD01Y	20
TN6U24-0428S1B	39	TN7U24-0428P1L	42	TNM6S16-0019P1L	50	TR2028RMH1NB	28	TST06RE01T	21
TN6U24-0428S1L	39	TN7U24-0428S1B01	38	TNM6S16-0019S1L	51	TR2028RMS1NB	28	TST06RE01Y	21
TN6U24-0428S2B	40	TN7U24-0428S1L	38	TNM6U10-0004P1L	50	TR22AAD	30	TST09PF00	19
TN6U24-0428S2L	40	TN7U24-1219P1B01	42	TNM6U10-0004S1L	51	TR22AHC1N	31	TST09RD01T	20
TN6U24-1219P1B	35	TN7U24-1219P1L	42	TNM6U12-0008P1L	50	TR22ASR1N	31	TST09RD01Y	20
TN6U24-1219P2B	36	TN7U24-1219S1B01	38	TNM6U12-0008S1L	51	TR2235PFS1NB	27	TST09RE01T	21
TN6U24-1219P1L	35	TN7U24-1219S1L	38	TNM6U14-0012P1L	50	TR2235PMS1NB	25	TST09RE01Y	21
TN6U24-1219P2L	36	TNA10CCHC-00L	56	TNM6U14-0012S1L	51	TR2235RFH1NB	26	TST10PF00	19
TN6U24-1219S1B	39	TNA10CCSE-00L	55	TNM6U16-0019P1L	50	TR2235RFS1NB	26	TST10RD01T	20
TN6U24-1219S1L	39	TNA10CCSR-00L	56	TNM6U16-0019S1L	51	TR2235RMH1NB	28	TST10RD01Y	20
TN6U24-1219S2B	40	TNA10HSAD-00L	54	TNM7S14-0304P1L	52	TR2235RMS1NB	28	TST10RE01T	21
TN6U24-1219S2L	40	TNA10CCSE-01L	54	TNM7S14-0304S1L	52	TR24AAD	30	TST10RE01Y	21
TN7G14-0012P1B01	42	TNA12CCHC-00L	56	TP03R3E00Y	13	TR24AHC1N	31	TST12AH00	10
TN7G14-0012P1L	42	TNA12CCSE-00L	55	TP03R4E00Y	12	TR24ASR1N	31	TST12AS00	11
TN7G14-0012S1B01	38	TNA12CCSR-00L	56	TP04R3E00Y	13	TR2448PFS1NB	27	TST12PA00	10
TN7G14-0012S1L	38	TNA12CCSE-01L	54	TP04R4E00Y	12	TR2448PMS1NB	25	TST12RA00	11
TN7G16-0019P1B01	42	TNA12HSAD-00L	54	TP06R3E00Y	13	TR2448RFH1NB	26	TST12RB01T	12
TN7G16-0019P1L	42	TNA14CCHC-00L	56	TP06R4E00Y	12	TR2448RFS1NB	26	TST12RB01Z	12
TN7G16-0019S1B01	38	TNA14CCSE-00L	55	TP09R3E00Y	13	TR2448RMH1NB	28	TST12RB02T	13
TN7G16-0019S1L	38	TNA14CCSR-00L	44, 56	TP09R4E00Y	12	TR2448RMS1NB	28	TST12RB02Z	13
TN7G24-0048P1B01	42	TNA14CCSE-01L	54	TP10R3E00Y	13	TST02AH00	10	TST12RB05T	12
TN7G24-0048P1L	42	TNA14CCSE-01L	54	TP10R4E00Y	12	TST02PA00	10	TST12RB05Y	12
TN7G24-0048S1B01	38	TNA14DCPO-00B	47	TR10AAD	30	TST02RA00	11	TST12RB06T	13
TN7G24-0048S1L	38	TNA14DCRO-01B	47	TR10AHC1N	31	TST02RB01T	12	TST12RB06Y	13
TN7G24-0420P1B01	42	TNA14JN00-00B	46	TR10ASR1N	31	TST02RB01Z	12	TST24AH00	10
TN7G24-0420P1L	42	TNA14HSAD-00L	54	TR1004PFS1NB	27	TST02RB02T	13	TST24AS00	11
TN7G24-0420S1B01	38	TNA14PG01-00	47	TR1004PMS1NB	25	TST02RB02Z	13	TST24PA00	10
TN7G24-0420S1L	38	TNA14PG03-00	47	TR1004RFH1NB	26	TST02RB05T	12	TST24RA00	11
TN7G24-0420S2B	40	TNA16CA01-20L	45	TR1004RFS1NB	26	TST02RB05Y	12	TST24RB01T	12
TN7G24-0428P1B01	42	TNA16CA02-18L	45	TR1004RMH1NB	28	TST02RB06T	13	TST24RB01Z	12
TN7G24-0428P1L	42	TNA16CA22-18L	41	TR1004RMS1NB	28	TST02RB06Y	13	TST24RB02T	13
TN7G24-0428S1B01	38	TNA16CCHC-00L	56	TR12AAD	30	TST03AH00	10	TST24RB02Z	13
TN7G24-0428S1L	38	TNA16CCSE-00L	55	TR12AHC1N	31	TST03AS00	11	TST24RB05T	12
TN7G24-1219S1B01	38	TNA16CCSR-00L	44, 56	TR12ASR1N	31	TST03PA00	10	TST24RB05Y	12
TN7G24-1219P1B01	42	TNA16CCSE-01L	54	TR1208PFS1NB	27	TST03PF00	19	TST24RB06T	13
TN7G24-1219P1L	42	TNA16HSAD-00L	54	TR1208PMS1NB	25	TST03RA00	11	TST24RB06Y	13
TN7G24-1219S1L	38	TNA16DCPO-00B	47	TR1208RFH1NB	26	TST03RB01T	12	TST36AH00	10
TN7L24-0048P1B01	42	TNA16DCRO-01B	47	TR1208RFS1NB	26	TST03RB01Z	12	TST36AS00	11
TN7L240048P1L	42	TNA16JN00-00B	46	TR1208RMH1NB	28	TST03RB02T	13	TST36PA00	10
TN7L24-0048S1B01	38	TNA16PG01-00	47	TR1208RMS1NB	28	TST03RB02Z	13	TST36RA00	11
TN7L24-0048S1L	38	TNA16PG03-00	47	TR14AAD	30	TST03RB05T	12	TST36RB01T	12
TN7L24-0048P1L	38	TNA24CA01-20L	45	TR14AHC1N	31	TST03RB05Y	12	TST36RB01Z	12
TN7U16-0213P1B01	42	TNA24CA01-25L	45	TR14ASR1N	31	TST03RB06T	13	TST36RB02T	13
TN7U16-0213P1L	42	TNA24CA02-25L	45	TR1412PFS1NB	27	TST03RB06Y	13	TST36RB02Z	13
TN7U24-0420P1B01	42	TNA24CA02-26L	45	TR1412PMS1NB	25	TST03RD01T	20	TST36RB05T	12
TN7U24-0420P1L	42	TNA24CA03-34L	45	TR1412RFH1NB	26	TST03RD01Y	20	TST36RB05Y	12
TN7S14-0012P1B01	42	TNA24CA22-26L	41	TR1412RFS1NB	26	TST03RE01T	21	TST36RB06T	13
TN7S14-0012P1L	42	TNA24CCHC-00L	44	TR1412RMH1NB	28	TST03RE01Y	21	TST36RB06Y	13
TN7S14-0012S1B01	38	TNA24CCSR-00L	44	TR1412RMS1NB	28	TST04AH00	10		
TN7S14-0012S1L	38	TNA24DCPO-00B	47	TR16AAD	30	TST04AS00	11		
TN7S16-0019P1B01	42	TNA24DCRO-01B	47	TR16AHC1N	31	TST04PA00	10		
TN7S16-0019P1L	42	TNA24JN00-00B	46	TR16ASR1N	31	TST04PF00	19		
TN7S16-0019S1B01	38	TNA24PG01-00	47	TR1619PFS1NB	27	TST04RA00	11		
TN7S16-0019S1L	38	TNA24PG03-00	47	TR1619PMS1NB	25	TST04RB01T	12		



1. MATERIAL CONTENT AND PHYSICAL FORM

Electrical connectors do not usually contain hazardous materials. They contain conducting and non-conducting materials and can be divided into two groups.

- a) Printed circuit types and low cost audio types which employ all plastic insulators and casings.
- b) Rugged, Fire Barrier and High Reliability types with metal casings and either natural rubber, synthetic rubber, plastic or glass insulating materials. Contact materials vary with type of connector and also application and are usually manufactured from either: Copper, copper alloys, nickel, alumel, chromel or steel. In special applications, other alloys may be specified.

2. FIRE CHARACTERISTICS AND ELECTRIC SHOCK HAZARD

There is no fire hazard when the connector is correctly wired and used within the specified parameters. Incorrect wiring or assembly of the connector or careless use of metal tools or conductive fluids, or transit damage to any of the component parts may cause electric shock or burns. Live circuits must not be broken by separating mated connectors as this may cause arcing, ionization and burning. Heat dissipation is greater at maximum resistance in a circuit. Hot spots may occur when resistance is raised locally by damage, e.g. cracked or deformed contacts, broken strands of wire. Local overheating may also result from the use of the incorrect application tools or from poor quality soldering or slack screw terminals. Overheating may occur if the ratings in the product Data Sheet/Catalog are exceeded and can cause breakdown of insulation and hence electric shock. If heating is allowed to continue it intensifies by further increasing the local resistance through loss of temper of spring contacts, formation of oxide film on contacts and wires and leakage currents through carbonization of insulation and tracking paths. Fire can then result in the presence of combustible materials and this may release noxious fumes. Overheating may not be visually apparent. Burns may result from touching overheated components.

3. HANDLING

Care must be taken to avoid damage to any component parts of electrical connectors during installation and use. Although there are normally no sharp edges, care must be taken when handling certain components to avoid injury to fingers. Electrical connectors may be damaged in transit to the customers, and damage may result in creation of hazards. Products should therefore be examined prior to installation/use and rejected if found to be damaged.

4. DISPOSAL

Incineration of certain materials may release noxious or even toxic fumes.

5. APPLICATION

Connectors with exposed contacts should not be selected for use on the current supply side of an electrical circuit, because an electric shock could result from touching exposed contacts on an unmated connector. Voltages in excess of 30 V ac or 42.5 V dc are potentially hazardous and care should be taken to ensure that such voltages cannot be transmitted in any way to exposed metal parts of the connector body. The connector and wiring should be checked, before making live, to have no damage to metal parts or insulators, no solder blobs, loose strands, conducting lubricants, swarf, or any other undesired conducting particles. Circuit resistance and continuity check should be made to make certain that there are no high resistance joints or spurious conducting paths. Always use the correct application tools as specified in the Data Sheet/Catalog. Do not permit untrained personnel to wire, assemble or tamper with connectors. For operation voltage please see appropriate national regulations.

IMPORTANT GENERAL INFORMATION

(i) Air and creepage paths/Operating voltage. The admissible operating voltages depend on the individual applications and the valid national and other applicable safety regulations.

For this reason the air and creepage path data are only reference values. Observe reduction of air and creepage paths due to PC board and/or harnessing.

(ii) Temperature

All information given are temperature limits. The operation temperature depends on the individual application.

(iii) Other important information

Cannon continuously endeavors to improve their products. Therefore, Cannon products may deviate from the description, technical data and shape as shown in this catalog and data sheets.

ITT Cannon, a brand of ITT INC manufactures the highest quality products available in the marketplace; however these products are intended to be used in accordance with the specifications in this publication. Any use or application that deviates from the stated operating specifications is not recommended and may be unsafe. No information and data contained in this publication shall be construed to create any liability on the part of Cannon. Any new issue of this publication shall automatically invalidate and supersede any and all previous issues.

Product Warranty

A limited warranty applies to Cannon products. In general, except for obligations assumed by Cannon under this warranty, Cannon shall not be liable for any loss, damage, cost of repairs, incidental or consequential damages of any kind, whether or not based on express or implied warranty, contract, negligence or strict liability arising in connection with the design, manufacture, sale, use or repair of the products. Product availability, prices and delivery dates are exclusively subject to our respective order confirmation form; the same applies to orders based on development samples delivered. Please refer to www.ittcannon.com (General Terms of Sale) for the complete text of Cannon's applicable Terms and Conditions, including Warranty.

This publication is not to be construed as an offer. It is intended merely as an invitation to make an offer. By this publication, Cannon does not assume responsibility or any liability for any patent infringements or other rights of third parties which may result from its use.

Reprinting this publication is generally permitted, indicating the source. However, Cannon's prior consent must be obtained in all cases. "Engineered for life" is a registered trademark of ITT INC 2018. All other trademarks or registered trademarks are property of their respective owners. All dates subject to change without notice.

Commodities in this catalog may be controlled for export by the International Traffic in Arms Regulations (ITAR) and Export Administration Regulations (EAR) when specifically designed modified, or configured for articles controlled by the United States Government.



Connect with your ITT Cannon representative today
or visit us at www.ittcannon.com

Connect with the experts

ITT's Cannon brand is a world leader in the design and manufacture of highly engineered connector solutions for multiple end markets.



ENGINEERED FOR LIFE

North America

Irvine
Phone: +1.800.854.3028

Europe

Italy
Phone: +39.02938721

Germany
Phone: +49.7151.699.0

Asia

China
Phone: +86.755.2726.7888

Данный компонент на территории Российской Федерации

Вы можете приобрести в компании MosChip.

Для оперативного оформления запроса Вам необходимо перейти по данной ссылке:

<http://moschip.ru/get-element>

Вы можете разместить у нас заказ для любого Вашего проекта, будь то серийное производство или разработка единичного прибора.

В нашем ассортименте представлены ведущие мировые производители активных и пассивных электронных компонентов.

Нашей специализацией является поставка электронной компонентной базы двойного назначения, продукции таких производителей как XILINX, Intel (ex.ALTERA), Vicor, Microchip, Texas Instruments, Analog Devices, Mini-Circuits, Amphenol, Glenair.

Сотрудничество с глобальными дистрибьюторами электронных компонентов, предоставляет возможность заказывать и получать с международных складов практически любой перечень компонентов в оптимальные для Вас сроки.

На всех этапах разработки и производства наши партнеры могут получить квалифицированную поддержку опытных инженеров.

Система менеджмента качества компании отвечает требованиям в соответствии с ГОСТ Р ИСО 9001, ГОСТ РВ 0015-002 и ЭС РД 009

Офис по работе с юридическими лицами:

105318, г.Москва, ул.Щербаковская д.3, офис 1107, 1118, ДЦ «Щербаковский»

Телефон: +7 495 668-12-70 (многоканальный)

Факс: +7 495 668-12-70 (доб.304)

E-mail: info@moschip.ru

Skype отдела продаж:

moschip.ru

moschip.ru_4

moschip.ru_6

moschip.ru_9