

cannon

Trident Series



ITT

ENGINEERED FOR LIFE

We Connect

When it matters most

For more than a century, ITT Cannon has developed innovative interconnect solutions for the world's harshest environments. With facilities in the United States, Germany, Italy, Mexico, China and Japan, each with its unique strengths, we offer our customers interconnect solutions that are truly Engineered for Life.

In addition to this truly global footprint, we offer highly specialized, segmented industry expertise. We have a proven track record as an industry leader in harsh-environment applications. This has equipped us with the knowledge needed to continue to produce the most resilient, reliable connectors for our customers' most challenging conditions.

Interconnect solutions for the harshest environments.

The ITT Cannon difference

- Global capabilities & local support
- Proven application expertise
- A century of interconnect leadership
- A committed innovator & business partner

The logo for Cannon, featuring the word "cannon" in a lowercase, sans-serif font. The letter "o" is replaced by a stylized icon of a gun barrel with three bullet holes.

About ITT

ITT is a diversified leading manufacturer of highly engineered critical components and customized technology solutions for the energy, transportation and industrial markets. Building on its heritage of innovation, ITT partners with its customers to deliver enduring solutions to the key industries that underpin our modern way of life. Founded in 1920, ITT is headquartered in White Plains, N.Y., with employees in more than 35 countries and sales in a total of approximately 125 countries. For more information, visit www.itt.com.





Industrial / Instrumentation



Defense Vehicles



Medical



Heavy Equipment



Rail



Oil & Gas



Commercial & Military Aerospace

Our connector portfolio remains the most extensive in the industry.

Offering a reliable and cost effective range of interconnect solutions.

Additional interconnect solutions utilizing the trusted and proven Trident contact system



ITT Cannon's Trident T2P and T3P contact technology is an extremely reliable and effective solution for harsh environment interconnects. In addition to the extensive Trident range, this contact technology is used in a number of ITT Cannon and Veam connector series including:



CTC Series

This cost-effective, footprint minimized solution for harsh environment vehicle wiring applications is available in 8 to 24-way layouts. Extremely simple to install and maintain it delivers an IP69K sealing without the need for wedge locks or blind seals.



APD Series

This full-plastic, proven bayonet series with IP69K sealing and color and mechanical coding is an ideal solution for multiple harsh transportation and industrial environments that require high sealing grades.



VRPC Series

This full plastic rectangular sealed connector series for multiple transport and industrial applications is extremely durable, small and light weight and meets stringent NFF fire and smoke resistance standards for Rail.

Cannon’s Trident Connector System is a versatile range of electrical connectors based on a standard contact design. These contacts are fully interchangeable throughout the Trident Connector System. The connector options include low cost retangulars, rack and panel, industrial grade circulars, harsh environment circulars and shielded circulars.

Description

Trident Connector System

Connector Selection Guide 6

- Snap Together - Rectangular
 - Introduction 7
 - How to Order 8
 - Contact Cavity Arrangements 9
 - Connectors 10-13
- Flame Retardant - Rectangular
 - Introduction 14
 - Contact Cavity Arrangements 15
 - Connectors 16-17
- Snap Together - Slimline
 - Introduction 18
 - How to Order 19
 - Connectors 19-21
- Ringlock Circular Connectors
 - Introduction 22
 - How to Order 23
 - Contact Cavity Arrangements 24
 - Connectors 25-28
 - Accessories 29-31
- Neptune Circular Connectors
 - Introduction 31
 - How to Order 33
 - Contact Cavity Arrangements 34
 - Connectors 35-42
 - Accessories 43-47
- TNM Circular Connectors
 - Introduction 48
 - How to Order 49
 - Contact Cavity Arrangements 49
 - Connectors 50-53
 - Accessories 54-56
- High Voltage
 - Introduction 57
 - Connectors 58
- Contacts
 - Introduction and Performance Data 59
 - Contact Selection Guide 60-61
 - T2P 62-63
 - T3P 64-67
 - Power 67

Tools 70-71

Assembly Instructions 72-79

Reader’s Resource

- IP Rating Chart 81-82
- Glossary of Terms 83-84
- Part Number Index 85-87
- Product Safety Information 88
- Warranty 88

| | Snap Together | | Flame Retardant | Circular | | | |
|--------------------------------|---|---|---|---|--|--|---|
| | Rectangular | Slimline | Rectangular | Ringlock | Neptune | Neptune Metal (TNM) | High Voltage (THV) |
| |  |  |  |  |  |  |  |
| Operating Voltage ¹ | Up to 250 V ac rms | Up to 250 V ac rms | Up to 250 V ac rms | Up to 250 V ac rms Up to 380 V ac rms (7 position connector only) | Up to 250 V ac rms | Up to 250 V ac rms | Up to 500 V ac rms |
| Current Rating ² | Up to 13 A | Up to 10 A | Up to 13 A | Up to 13 A Up to 16 A with High Conductivity Contacts | Up to 13 A Up to 16 A with High Conductivity Contacts Up to 30 A with Power Contacts | Up to 13 A Up to 16 A with High Conductivity Contacts Up to 30 A with Power Contacts Up to 40 A with D Sub Contacts | Up to 34 A with Power Contacts |
| Operating Temperature | -55°C to +105°C (-67°F to +221°F) (from -40°C, -40°F for PCB versions) | -55°C to +105°C (-67°F to +221°F) (from -40°C, -40°F for PCB versions) | -55°C to +105°C (-67°F to +221°F) | -55°C to +105°C (-67°F to +221°F) | -55°C to +105°C (-67°F to +221°F) | -55°C to +105°C (-67°F to +221°F) | -40°C to +125°C (-40°F to +257°F) |
| Insulation Resistance | 5000 MW at 500 V dc | 5000 MW at 500 V dc | 5000 MW at 500 V dc | 5000 MW at 500 V dc | 5000 MW at 500 V dc | 5000 MW at 500 V dc | 5000 MW at 500 V dc |
| Durability ³ | Up to 500 Mating Cycles | Up to 500 Mating Cycles | Up to 500 Mating Cycles | Up to 500 Mating Cycles | Up to 500 Mating Cycles | Up to 200 Mating Cycles | Up to 200 Mating Cycles |
| Environmental Sealing | - | - | - | Up to IP65 | Up to IP67 | Up to IP67 | Up to IP67 |
| Flammability | UL 94 V-0 | UL 94 V-0 | I2/F2 according to NFF 16-101 (fire & smoke standards) UL 94 V-0 | UL 94 V-0 | UL 94 V-0 | UL 94 V-0 | UL 94 V-0 |
| Insulator | Black Nylon | Black Nylon | Gray Nylon | Black Nylon | Black Nylon | Black Nylon | Orange Nylon |
| Coupling Ring | - | - | - | Nickel Plated Brass | Nickel Plated Brass | Nickel Plated Brass | Nickel Plated Brass |
| Layouts | 2, 3, 4, 6, 12, 24, 36 | 3, 4, 6, 9, 10 | 2, 3, 4, 6, 12, 24, 36 | 4, 7, 8, 12, 19, 23, 28, 35, 48 | 12+0, 19+0 13+2, 20+4, 28+4, 48+0, 19+12 ** | 4+0, 8+0, 12+0, 3+3, 4+3, 0+4, 19+0 ** | 4 |
| Page | 7-13 | 18-21 | 14-17 | 22-31 | 32-47 | 48-56 | 57-58 |

* For details please consult the factory

** Signal + Power contacts

1 Depends on contacts used, layout, and degree of pollution

2 Depends on number and type of contacts used

3 Depends on plating and type of contacts used



These are low installed cost connectors rated for up to 13 A and 250 V ac. They are typically used for circuit board and internal wiring applications. Snap Together connectors facilitate easy assembly and removal of equipment such as motors, fans, transformers, etc. All Snap Together - Rectangular connectors are RoHS Compliant.



Applications:

- Vehicle Dashboards.
- Circuit board connections.
- Internal connections.

Product Features

- Easy cost effective installation.
- Integrally molded latches and connector polarization.
- Recognized under the component program of UL Inc.
- Inter-connector discrimination facilities available.
- Accepts formed (stamped) or machined contacts, see page 64.



Performance Specifications

Materials and Finishes

| | |
|------------------|------------------------|
| Insulator | Black Nylon, UL 94 V-0 |
|------------------|------------------------|

| | |
|-------------------------------------|--|
| Operating Voltage ¹ | Up to 250 V ac rms |
| Contact Current Rating ² | Up to 13 A |
| Operating Temperature | -55°C to +105°C (-67°F to +221°F) for free Plug and Receptacles -40°C to +105°C (-40°F to +221°F) for PCB Mounted Receptacles |
| Insulation Resistance | 5000MW min. at 500 V dc |
| Durability ³ | Up to 500 Mating Cycles |
| Connector Latching Force | 150 N min. with latches engaged |
| Panel Retention Force | 500 N min. |
| Flammability | UL 94 V-0 |

¹ Depends on contacts used, layout, and degree of pollution

² Depends on number and type of contacts used

³ Depends on plating and type of contacts used

How to Order

Typical Nomenclature:



| Type | |
|------|--|
| PA | Plug; Free |
| RB | Receptacle; For PCB, with Mounting Lugs |
| RA | Receptacle; Panel Mounting (delivered without any contacts) |
| RR | Receptacle, For PCB, 90° Right Angle Mounting (only for 12 position connectors with machined contacts) |
| AS | Accessory; Receptacle Shroud |
| AH | Accessory; Plug Strain Relief Hood |

Test Specifications

The table below summarizes the results of key tests. Data is applicable to standard connectors with standard contacts. Variations may affect this data, so please consult factory for further information on your requirements.

| Test | Method | Criteria of Acceptance |
|---------------------------------|--|--|
| Dielectric Withstanding Voltage | 2000 V ac | No breakdown |
| Thermal Shock | -55°C to +125°C (-67°F to +257°F), 5 cycles | No physical damage |
| Physical Shock | 50 g's peak, 3 axes, 11 millisecond duration half-sine pulse | No physical damage. No loss of continuity >1 sec |
| Vibration | 10 g's peak, 10-500 Hz, 9 hours | No physical damage, No loss of continuity >1 sec |
| Durability | 500 cycles of mating and unmating, 500 mating cycles max | No mechanical or electrical defects |
| Salt Spray | 48 hours | Shall be capable of mating and unmating and meet contact resistance requirements |
| High Temperature Endurance | 1000 hours at 125°C (+257°F) | Insulation Resistance > 100 MΩ |
| Humidity Steady State | RH 90-95%, 40°C (+104°F), 504 hours | Insulation Resistance > 100 MΩ |
| Moisture Resistance | 10 Cycles | Insulation Resistance > 100 MΩ |



Contact Cavity Arrangements – Mating Face View

2-way



3-way



4-way



6-way



12-way



24-way



36-way





Free Plug

- Accepts Pin or Socket contacts.
- Contacts to be ordered separately, see page 64.
- Mates with panel mounted receptacles, see page 11.
- Mates with PCB mounted receptacles, see pages 12-13.
- Connector Discriminating (Keying) Pins available, see page 69.

| Number of Contacts | Pack of 100 Part Number | Nomenclature | Dimensions (max.) | |
|--------------------|-------------------------|--------------|-------------------|---------------|
| | | | A | B |
| 2 | 192990-0350 | TST02PA00 | 15,50 (.610) | 17,00 (.669) |
| 3 | 192923-5920 | TST03PA00 | 19,00 (.748) | 17,00 (.669) |
| 4 | 192990-0370 | TST04PA00 | 24,00 (.944) | 17,00 (.669) |
| 6 | 192923-5930 | TST06PA00 | 19,00 (.748) | 22,00 (.866) |
| 12 | 192923-5940 | TST12PA00 | 19,00 (.748) | 32,00 (1.259) |
| 24 | 192923-5950 | TST24PA00 | 24,00 (.944) | 42,00 (1.653) |
| 36 | 192923-5960 | TST36PA00 | 49,50 (1.948) | 32,00 (1.259) |



Accessory – Plug Strain Relief Hood

- Provides strain relief and wire protection.
- Secure with a tie-wrap (customer supplies tie-wrap).



| Number of Contacts | Pack of 100 Part Number | Nomenclature | Wire Bundle Dia. | Dimensions (max.) | | | |
|--------------------|-------------------------|--------------|------------------------|-------------------|---------------|---------------|---------------|
| | | | | A | B | C | D |
| 2 | 192990-0460 | TST02AH00 | 2,30-8,30 (.090-.326) | 46,20 (1.818) | 16,10 (.633) | 11,00 (.433) | 56,50 (2.224) |
| 3 | 192990-0470 | TST03AH00 | 2,30-8,30 (.090-.326) | 46,20 (1.818) | 18,60 (.732) | 11,00 (.433) | 56,50 (2.224) |
| 4 | 192990-0480 | TST04AH00 | 3,00-10,00 (.118-.393) | 46,20 (1.818) | 23,70 (.933) | 11,00 (.433) | 56,50 (2.224) |
| 6 | 192923-5970 | TST06AH00 | 2,30-8,30 (.090-.326) | 46,20 (1.818) | 19,00 (.748) | 16,40 (.645) | 56,50 (2.224) |
| 12 | 192923-5980 | TST12AH00 | 3,00-10,00 (.118-.393) | 45,50 (1.791) | 19,00 (.748) | 26,40 (1.039) | 55,80 (2.196) |
| 24 | 192923-5990 | TST24AH00 | 4,60-12,70 (.181-.500) | 51,00 (2.007) | 24,10 (.948) | 36,80 (1.448) | 60,30 (2.374) |
| 36 | 192923-6000 | TST36AH00 | 7,00-15,90 (.275-.625) | 57,50 (2.263) | 49,50 (1.948) | 26,40 (1.039) | 68,00 (2.677) |





Receptacle – Panel Mounted

- Accepts Pin or Socket contacts.
- Contacts to be ordered separately, see page 60.
- Mates with Free Plugs, see page 10.
- Connector Discriminating (Keying) Pins available, see page 69.



| Number of Contacts | Pack of 100 | | Dimensions | | | |
|--------------------|-------------|--------------|---------------|---------------|-------------------|-------------------|
| | Part Number | Nomenclature | A | B | C ±0,13 (.005) | D ±0,13 (.005) |
| 2 | 192990-0360 | TST02RA00 | 19,00 (.748) | 14,00 (.551) | 11,50 (.452) | 11,60 (.456) |
| 3 | 192923-6010 | TST03RA00 | 24,00 (.944) | 14,00 (.551) | 16,50 (.649) | 11,60 (.456) |
| 4 | 192990-0380 | TST04RA00 | 29,00 (1.141) | 14,00 (.551) | 21,70 (.854) | 11,60 (.456) |
| 6 | 192923-6020 | TST06RA00 | 24,00 (.944) | 19,00 (.748) | 16,50 (.649) | 16,70 (.657) |
| 12 | 192923-6030 | TST12RA00 | 24,00 (.944) | 29,00 (1.141) | 16,70 (.657) | 26,70 (1.051) |
| 24 | 192923-6040 | TST24RA00 | 29,00 (1.141) | 39,00 (1.535) | 21,80 (.858) | 36,90 (1.452) |
| 36 | 192923-6050 | TST36RA00 | 54,20 (2.133) | 29,00 (1.141) | 46,70 (1.838) | 26,40 (1.039) |



Section X-X

Accessory – Protection Shrouds for Receptacles with Pin Contacts

- Provides protection for panel mounted receptacles with pin contacts.
- Shrouds can be fitted onto panels up to 1,40 (.055) thick.

| Number of Contacts | Pack of 100 | | Dimensions | |
|--------------------|-------------|--------------|---------------|---------------|
| | Part Number | Nomenclature | A | B |
| 3 | 192990-0400 | TST03AS00 | 23,50 (.925) | 19,05 (.748) |
| 4 | 192991-0668 | TST04AS00 | 28,60 (1.126) | 19,05 (.748) |
| 6 | 192990-0420 | TST06AS00 | 23,50 (.925) | 24,13 (.948) |
| 12 | 192990-0430 | TST12AS00 | 23,60 (.929) | 34,20 (1.346) |
| 24 | 192990-0440 | TST24AS00 | 29,70 (1.169) | 44,40 (1.748) |
| 36 | 192990-0450 | TST36AS00 | 54,40 (2.141) | 34,00 (1.338) |

Dimensions shown in mm (inch)
Specifications and dimensions subject to change

Figure 1



Receptacle –
PCB Mounted
with Pin Contacts

- Mates with Free Plug, see page 10.
- Integrally molded flanges.
- Contacts are on a 5,08 (.200) grid, symmetrical on center lines.
- Recommended PCB hole Ø1,15 (.045).
- Connector Discriminating Caps available, see page 69.

Figure 2



Pack of 100

| Number of Contacts | Plating | Formed (Stamped) | | Machined | | Figure | Dimensions | | | | |
|-----------------------|---------|------------------|--------------|-------------|--------------|--------|---------------|-------------------|-------------------|---------------|---------------|
| | | Part Number | Nomenclature | Part Number | Nomenclature | | A | B ±0,08 (.003) | C ±0,08 (.003) | D | E |
| 2 | Gold* | 192900-0411 | TST02RB05Y | 192991-0270 | TST02RB01Z | 1 | 11,13 (.438) | N/A | 19,13 (.753) | 6,00 (.236) | 25,00 (.984) |
| 2 | Tin | 192990-3230 | TST02RB05T | 192991-0271 | TST02RB01T | 1 | 11,13 (.438) | N/A | 19,13 (.753) | 6,00 (.236) | 25,00 (.984) |
| 3 | Gold* | 192900-0412 | TST03RB05Y | 192991-0278 | TST03RB01Z | 2 | 16,21 (.638) | 14,05 (.553) | 10,24 (.403) | 6,00 (.236) | 20,10 (.791) |
| 3 | Tin | 192990-3240 | TST03RB05T | 192991-0279 | TST03RB01T | 2 | 16,21 (.638) | 14,05 (.553) | 10,24 (.403) | 6,00 (.236) | 20,10 (.791) |
| 4 | Gold* | 192900-0413 | TST04RB05Y | 192991-0286 | TST04RB01Z | 2 | 21,30 (.838) | 14,05 (.553) | 15,32 (.603) | 6,00 (.236) | 20,10 (.791) |
| 4 | Tin | 192990-3250 | TST04RB05T | 192991-0287 | TST04RB01T | 2 | 21,30 (.838) | 14,05 (.553) | 15,32 (.603) | 6,00 (.236) | 20,10 (.791) |
| 6 | Gold* | 192900-0414 | TST06RB05Y | 192991-0294 | TST06RB01Z | 2 | 16,20 (.637) | 19,12 (.752) | 10,23 (.402) | 11,00 (.433) | 26,00 (1.023) |
| 6 | Tin | 192990-3260 | TST06RB05T | 192991-0295 | TST06RB01T | 2 | 16,20 (.637) | 19,12 (.752) | 10,23 (.402) | 11,00 (.433) | 26,00 (1.023) |
| 12 | Gold* | 192900-0415 | TST12RB05Y | 192991-0302 | TST12RB01Z | 2 | 16,20 (.637) | 29,30 (1.153) | 10,26 (.404) | 21,20 (.834) | 35,20 (1.385) |
| 12 | Tin | 192990-3270 | TST12RB05T | 192991-0303 | TST12RB01T | 2 | 16,20 (.637) | 29,30 (1.153) | 10,26 (.404) | 21,20 (.834) | 35,20 (1.385) |
| 24 | Gold* | 192900-0416 | TST24RB05Y | 192991-0310 | TST24RB01Z | 2 | 21,30 (.838) | 39,37 (1.550) | 15,32 (.603) | 31,30 (1.232) | 45,60 (1.795) |
| 24 | Tin | 192990-3280 | TST24RB05T | 192991-0311 | TST24RB01T | 2 | 21,30 (.838) | 39,37 (1.550) | 15,32 (.603) | 31,30 (1.232) | 45,60 (1.795) |
| 36 | Gold* | 192900-0417 | TST36RB05Y | 192991-0402 | TST36RB01Z | 1 | 46,60 (1.834) | 15,24 (.600) | 54,64 (2.151) | 21,20 (.834) | 60,50 (2.382) |
| 36 | Tin | 192990-3290 | TST36RB05T | 192991-0403 | TST36RB01T | 1 | 46,60 (1.834) | 15,24 (.600) | 54,64 (2.151) | 21,20 (.834) | 60,50 (2.382) |

* Gold plating for Formed (Stamped) Contacts is 0,75 µm (30 µ in.) min gold. Gold plating for Machined Contacts is gold flash.





Figure 1



Receptacle –
PCB Mounted
with Socket Contacts

- Mates with Free Plug, see page 10.
- Integrally molded flanges.
- Contacts are on a 5,08 (.200) grid, symmetrical on center lines.
- Recommended PCB hole Ø 1,15 (.045).
- Connector Discriminating Pegs available, see page 69.

Figure 2



Pack of 100

| Number of Contacts | Formed (Stamped) | | Machined | | Figure | Dimensions | | | | | |
|-----------------------|------------------|-------------|--------------|-------------|------------|--------------|---------------|-------------------|-------------------|---------------|---------------|
| | Plating | Part Number | Nomenclature | Part Number | | Nomenclature | A | B ±0,08 (.003) | C ±0,08 (.003) | D | E |
| 2 | Gold* | 192900-0418 | TST02RB06Y | 192991-0213 | TST02RB02Z | 1 | 11,13 (.438) | N/A | 19,13 (.753) | 6,00 (.236) | 25,00 (.984) |
| 2 | Tin | 192990-3300 | TST02RB06T | 192991-0214 | TST02RB02T | 1 | 11,13 (.438) | N/A | 19,13 (.753) | 6,00 (.236) | 25,00 (.984) |
| 3 | Gold* | 192900-0419 | TST03RB06Y | 192991-0221 | TST03RB02Z | 2 | 16,21 (.638) | 14,05 (.553) | 10,24 (.403) | 6,00 (.236) | 20,10 (.791) |
| 3 | Tin | 192990-3310 | TST03RB06T | 192991-0222 | TST03RB02T | 2 | 16,21 (.638) | 14,05 (.553) | 10,24 (.403) | 6,00 (.236) | 20,10 (.791) |
| 4 | Gold* | 192900-0420 | TST04RB06Y | 192991-0229 | TST04RB02Z | 2 | 21,30 (.838) | 14,05 (.553) | 15,32 (.603) | 6,00 (.236) | 20,10 (.791) |
| 4 | Tin | 192990-3320 | TST04RB06T | 192991-0230 | TST04RB02T | 2 | 21,30 (.838) | 14,05 (.553) | 15,32 (.603) | 6,00 (.236) | 20,10 (.791) |
| 6 | Gold* | 192900-0421 | TST06RB06Y | 192991-0237 | TST06RB02Z | 2 | 16,20 (.637) | 19,12 (.752) | 10,23 (.402) | 11,00 (.433) | 26,00 (1.023) |
| 6 | Tin | 192990-3330 | TST06RB06T | 192991-0238 | TST06RB02T | 2 | 16,20 (.637) | 19,12 (.752) | 10,23 (.402) | 11,00 (.433) | 26,00 (1.023) |
| 12 | Gold* | 192900-0422 | TST12RB06Y | 192991-0245 | TST12RB02Z | 2 | 16,20 (.637) | 29,30 (1.153) | 10,26 (.404) | 21,20 (.834) | 35,20 (1.385) |
| 12 | Tin | 192990-3340 | TST12RB06T | 192991-0246 | TST12RB02T | 2 | 16,20 (.637) | 29,30 (1.153) | 10,26 (.404) | 21,20 (.834) | 35,20 (1.385) |
| 24 | Gold* | 192900-0423 | TST24RB06Y | 192991-0253 | TST24RB02Z | 2 | 21,30 (.838) | 39,37 (1.550) | 15,32 (.603) | 31,30 (1.232) | 45,60 (1.795) |
| 24 | Tin | 192990-3350 | TST24RB06T | 192991-0254 | TST24RB02T | 2 | 21,30 (.838) | 39,37 (1.550) | 15,32 (.603) | 31,30 (1.232) | 45,60 (1.795) |
| 36 | Gold* | 192900-0424 | TST36RB06Y | 192991-0261 | TST36RB02Z | 1 | 46,60 (1.834) | 15,24 (.600) | 54,64 (2.151) | 21,20 (.834) | 60,50 (2.382) |
| 36 | Tin | 192990-3360 | TST36RB06T | 192991-0262 | TST36RB02T | 1 | 46,60 (1.834) | 15,24 (.600) | 54,64 (2.151) | 21,20 (.834) | 60,50 (2.382) |

* Gold plating for Formed (Stamped) Contacts is 0,75 µm (30 µ in.) min gold. Gold plating for Machined Contacts is gold flash.

This connector series is compliant to railway standards. The material properties are I2/F2 according to NFF 16-101 & NFF 16-102. These are low installed cost connectors rated for up to 13 A and 250 V ac. They are typically used for circuit board and internal wiring applications. All flame retardant connectors are RoHS Compliant.



Applications:

- Vehicle Dashboards.
- Circuit board connections.
- Internal connections.
- Railway.
- Lighting.
- Cabin Applications.
- Control Consoles.

Product Features

- Material properties I2/F2 according to NFF 16-101 & NFF 16-102
- Easy cost effective installation.
- Integrally molded latches and connector polarization.
- Accepts formed (stamped) or machined contacts, see page 64.



Performance Specifications

Materials and Finishes

| | |
|------------------|------------|
| Insulator | Gray Nylon |
|------------------|------------|

| | |
|-------------------------------------|---|
| Operating Voltage ¹ | Up to 250 V ac rms |
| Contact Current Rating ² | Up to 13 A |
| Operating Temperature | -55°C to +105°C (-67°F to +221°F) for free Plug and Receptacles |
| Insulation Resistance | 5000Mw min. at 500 V dc |
| Durability ³ | Up to 500 Mating Cycles |
| Connector Latching Force | 150 N min. with latches engaged |
| Panel Retention Force | 500 N min. |
| Flammability | UL 94 V-0 |

¹ Depends on contacts used, layout, and degree of pollution

² Depends on number and type of contacts used

³ Depends on plating and type of contacts used

Contact Cavity Arrangements – Mating Face View

2-way



3-way



4-way



6-way



12-way



24-way



36-way





Free Plug

- Accepts Pin or Socket contacts.
- Contacts to be ordered separately, see page 60.
- Mates with panel mounted receptacles, see page 17.
- Connector Discriminating (Keying) Pins available, see page 68.

| Number of Contacts | Pack of 100 | | Dimensions (max.) | |
|--------------------|-------------|--------------|-------------------|---------------|
| | Part Number | Nomenclature | A | B |
| 2 | 121587-0010 | TFR02PA10 | 15,50 (.610) | 17,00 (.669) |
| 3 | 121587-0011 | TFR03PA10 | 19,00 (.748) | 17,00 (.669) |
| 4 | 121587-0012 | TFR04PA10 | 24,00 (.944) | 17,00 (.669) |
| 6 | 121587-0013 | TFR06PA10 | 19,00 (.748) | 22,00 (.866) |
| 12 | 121587-0014 | TFR12PA10 | 19,00 (.748) | 32,00 (1.259) |
| 24 | 121587-0015 | TFR24PA10 | 24,00 (.944) | 42,00 (1.653) |
| 36 | 121587-0016 | TFR36PA10 | 49,50 (1.948) | 32,00 (1.259) |



Accessory – Plug Strain Relief Hood

- Provides strain relief and wire protection.
- Secure with a tie-wrap (customer supplies tie-wrap).



| Number of Contacts | Pack of 100 | | | Dimensions (max.) | | | |
|--------------------|-------------|--------------|------------------------|-------------------|---------------|---------------|---------------|
| | Part Number | Nomenclature | Wire Bundle Dia. | A | B | C | D |
| 2 | 121587-0020 | TFR02AH10 | 2,30-8,30 (.090-.326) | 46,20 (1.818) | 16,10 (.633) | 11,00 (.433) | 56,50 (2.224) |
| 3 | 121587-0021 | TFR03AH10 | 2,30-8,30 (.090-.326) | 46,20 (1.818) | 18,60 (.732) | 11,00 (.433) | 56,50 (2.224) |
| 4 | 121587-0022 | TFR04AH10 | 3,00-10,00 (.118-.393) | 46,20 (1.818) | 23,70 (.933) | 11,00 (.433) | 56,50 (2.224) |
| 6 | 121587-0023 | TFR06AH10 | 2,30-8,30 (.090-.326) | 46,20 (1.818) | 19,00 (.748) | 16,40 (.645) | 56,50 (2.224) |
| 12 | 121587-0024 | TFR12AH10 | 3,00-10,00 (.118-.393) | 45,50 (1.791) | 19,00 (.748) | 26,40 (1.039) | 55,80 (2.196) |
| 24 | 121587-0025 | TFR24AH10 | 4,60-12,70 (.181-.500) | 51,00 (2.007) | 24,10 (.948) | 36,80 (1.448) | 60,30 (2.374) |
| 36 | 121587-0026 | TFR36AH10 | 7,00-15,90 (.275-.625) | 57,50 (2.263) | 49,50 (1.948) | 26,40 (1.039) | 68,00 (2.677) |



Kit –
Plug and Strain Relief Hood

- Provides protection for panel mounted receptacles with pin contacts.
- Shrouds can be fitted onto panels up to 1,40 (.055) thick.

| Number of Contacts | Pack of 100 | |
|--------------------|-------------|--------------|
| | Part Number | Nomenclature |
| 2 | 121587-0040 | TFR02PH10 |
| 3 | 121587-0041 | TFR03PH10 |
| 4 | 121587-0042 | TFR04PH10 |
| 6 | 121587-0043 | TFR06PH10 |
| 12 | 121587-0044 | TFR12PH10 |
| 24 | 121587-0045 | TFR24PH10 |
| 36 | 121587-0046 | TFR36PH10 |



Receptacle –
Panel Mounted

- Accepts Pin or Socket contacts.
- Contacts to be ordered separately, see page 60.
- Mates with Free Plugs, see page 16.
- Connector Discriminating (Keying) Pins available, see page 68.



| Number of Contacts | Pack of 100 | | Dimensions | | | |
|--------------------|-------------|--------------|---------------|---------------|-------------------|-------------------|
| | Part Number | Nomenclature | A | B | C ±0,13 (.005) | D ±0,13 (.005) |
| 2 | 121587-0030 | TFR02RA10 | 19,00 (.748) | 14,00 (.551) | 11,50 (.452) | 11,60 (.456) |
| 3 | 121587-0031 | TFR03RA10 | 24,00 (.944) | 14,00 (.551) | 16,50 (.649) | 11,60 (.456) |
| 4 | 121587-0032 | TFR04RA10 | 29,00 (1.141) | 14,00 (.551) | 21,70 (.854) | 11,60 (.456) |
| 6 | 121587-0033 | TFR06RA10 | 24,00 (.944) | 19,00 (.748) | 16,50 (.649) | 16,70 (.657) |
| 12 | 121587-0034 | TFR12RA10 | 24,00 (.944) | 29,00 (1.141) | 16,70 (.657) | 26,70 (1.051) |
| 24 | 121587-0035 | TFR24RA10 | 29,00 (1.141) | 39,00 (1.535) | 21,80 (.858) | 36,90 (1.452) |
| 36 | 121587-0036 | TFR36RA10 | 54,20 (2.133) | 29,00 (1.141) | 46,70 (1.838) | 26,40 (1.039) |

Dimensions shown in mm (inch)
Specifications and dimensions subject to change

The Slimline offers a low profile connector system that is well suited for circuit board applications. The precision machined contacts are ideal for power and sensitive signals. All Snap Together - Slimline connectors are RoHS Compliant.



Applications:

- Junction Boxes.
- Communications equipment.
- Test equipment.
- Instrumentation.

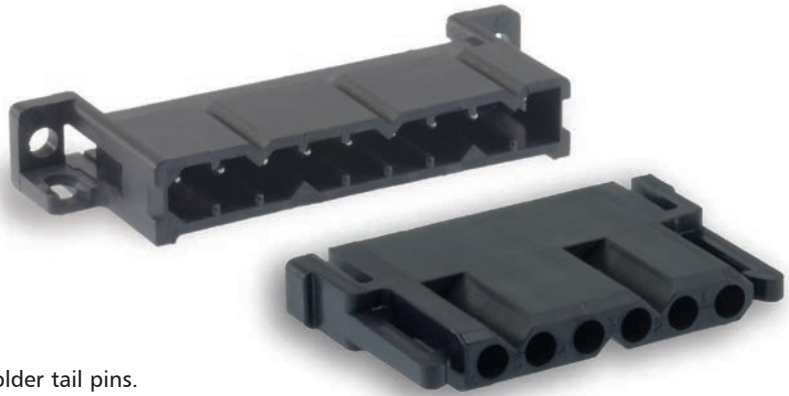

Product Features

- Less than 10,00 (.393) width on PC board.
- Pin headers pre-loaded with straight or 90° machined solder tail pins.
- Mating plug accepts all Trident signal crimp socket contacts, see page 60.
- Plugs have integrally molded quick connect/disconnect latches.
- Five single row contact arrangements available.
- Recognized under the component program of UL Inc.
- Gold plated version available with earth pin capability.
- 10 A per circuit.

Performance Specifications

| | |
|-------------------------------------|--|
| Operating Voltage ¹ | Up to 250 V ac rms |
| Contact Current Rating ² | Up to 10 A |
| Operating Temperature | -55°C to +105°C (-67°F to +221°F) for free Plug & Receptacles -40°C to +105°C (-40°F to +221°F) for PCB Mounted Receptacles |
| Insulation Resistance | 5000MW min. at 500 V dc |
| Durability ³ | Up to 500 Mating Cycles |
| Connector Latching Force | 150 N min. with latches engaged |
| Panel Retention Force | 500 N min. |
| Flammability | UL 94 V-0 |

Materials and Finishes

Insulator Black Nylon, UL 94 V-0

¹ Depends on contacts used, layout, and degree of pollution

² Depends on number and type of contacts used

³ Depends on plating and type of contacts used

Test Specifications

The table below summarizes the results of key tests. Data is applicable to standard connectors with standard contacts. Variations may affect this data, so please consult factory for further information on your requirements.

| Test | Method | Criteria of Acceptance |
|--|---|---|
| Dielectric Withstanding Voltage | 2000 V ac | No breakdown |
| Thermal Shock | -55°C to +125°C (-67°F to +257°F), 5 cycles | No physical damage |
| Physical Shock | 50 g's peak, 3 axes, 11 millisecond duration half-sine pulse | No physical damage. No loss of continuity >1 sec |
| Vibration | 10 g's peak, 10-500 Hz, 9 hours | No physical damage, No loss of continuity >1 sec |
| Durability 500 cycles of mating and unmating, 500 mating cycles max | No mechanical or electrical defects | |
| Salt Spray | 48 hours and meet contact resistance requirements | Shall be capable of mating and unmating |
| High Temperature Endurance | 1000 hours at 125°C (+257°F) | Insulation Resistance > 100 MΩ |
| Humidity Steady State | RH 90-95%, 40°C (+125°F), 504 hours | Insulation Resistance > 100 MΩ |
| Moisture Resistance | 10 Cycles | Insulation Resistance > 100 MΩ |



Dimensions shown in mm (inch)
Specifications and dimensions subject to change

How to Order

Typical Nomenclature:

TST 03 P F 0 0 *

Series

TST = Trident Snap Together

Number of Contacts

- 03
- 04
- 06
- 09
- 10

Plating Style

- * = None (Plug only)
- T = Tin
- Y = 0,4 mm Gold overall

Contact Type

- 0 = No Contacts (Standard for Plug and Panel Mounted Receptacle)
- 1 = Machined Solder Tail Pin
- 2 = Machined Solder Tail Socket
- 5 = Formed Stamped Solder Tail Pin
- 6 = Formed Stamped Solder Tail Socket

Color of Moulding

- 0 = Black

Variant

| | |
|----|-----------------------------------|
| RD | PCB Receptacle; Straight Contacts |
| RE | PCB Receptacle; 90° Contacts |
| PF | Plug |



Plug Connector

- Socket contacts must be ordered separately for the plug connectors, see page 60.

| Number of Contacts | Pack of 100 | | | D max. |
|--------------------|--------------|--------------|--|---------------|
| | Part Number | Nomenclature | | |
| 3 | 192990-0960* | TST03PF00 | | 16,10 (.633) |
| 4 | 192990-0970 | TST04PF00 | | 21,20 (.834) |
| 6 | 192990-0980 | TST06PF00 | | 31,40 (1.236) |
| 9 | 192990-0990 | TST09PF00 | | 46,60 (1.834) |
| 10 | 192990-1000 | TST10PF00 | | 51,60 (2.031) |

*Available in gray (material properties I2/F2 according to NFF 16-101 & NFF 16-102), part number: 192990-0965.



Receptacle with Straight Pin Contacts

- For gold plated versions extended earth pins are available in any one or two positions. Contact your local Cannon Sales Office for further details.

Pack of 100

| Number of Contacts | Gold Plated Version 0,4 μm (16 μin.) min. Gold | | Tin Plated Version | | Dimensions (max.) | | |
|--------------------|---|--------------|--------------------|--------------|-------------------|---------------|---------------|
| | Part Number | Nomenclature | Part Number | Nomenclature | A | B | C |
| 3 | 192991-0337 | TST03RD01Y | 192991-0316 | TST03RD01T | 31,40 (1.236) | 19,40 (.763) | 25,50 (1.003) |
| 4 | 192991-0347 | TST04RD01Y | 192991-0318 | TST04RD01T | 36,50 (1.437) | 14,50 (.964) | 30,60 (1.204) |
| 6 | 192991-0342 | TST06RD01Y | 192991-0320 | TST06RD01T | 46,70 (1.838) | 34,70 (1.366) | 40,70 (1.602) |
| 9 | 192991-0536 | TST09RD01Y | 192991-0322 | TST09RD01T | 61,90 (2.437) | 49,90 (1.964) | 56,00 (2.204) |
| 10 | 192991-0354 | TST10RD01Y | 192991-0324 | TST10RD01T | 67,00 (2.637) | 55,00 (2.165) | 61,10 (2.405) |

PCB Layout



| Number of Contacts | D max. |
|--------------------|---------------|
| 3 | 25,50 (1.003) |
| 4 | 30,60 (1.204) |
| 6 | 40,70 (1.602) |
| 9 | 56,00 (2.204) |
| 10 | 61,10 (2.405) |





Receptacle with 90° Pin Contacts

- For gold plated versions extended earth pins are available in any one or two positions. Contact your local Cannon Sales Office for further details.



Pack of 100

| Number of Contacts | Gold Plated Version 0,4 μ m (16 μ in.) min. Gold | | Tin Plated Version | | Dimensions (max.) | | |
|--------------------|---|--------------|--------------------|--------------|-------------------|---------------|---------------|
| | Part Number | Nomenclature | Part Number | Nomenclature | A | B | C |
| 3 | 192991-0532* | TST03RE01Y | 192991-0317 | TST03RE01T | 31,40 (1.236) | 19,40 (.763) | 25,50 (1.003) |
| 4 | 192991-0533 | TST04RE01Y | 192991-0319 | TST04RE01T | 36,50 (1.437) | 14,50 (.964) | 30,60 (1.204) |
| 6 | 192991-0534 | TST06RE01Y | 192991-0321 | TST06RE01T | 46,70 (1.838) | 34,70 (1.366) | 40,70 (1.602) |
| 9 | 192991-0535 | TST09RE01Y | 192991-0323 | TST09RE01T | 61,90 (2.437) | 49,90 (1.964) | 56,00 (2.204) |
| 10 | 192991-0538 | TST10RE01Y | 192991-0325 | TST10RE01T | 67,00 (2.637) | 55,00 (2.165) | 61,10 (2.405) |

*Available in gray (material properties I2/F2 according to NFF 16-101 & NFF 16-102), part number: 192991-0539.

PCB Layout



| Number of Contacts | D max. |
|--------------------|---------------|
| 3 | 25,50 (1.003) |
| 4 | 30,60 (1.204) |
| 6 | 40,70 (1.602) |
| 9 | 56,00 (2.204) |
| 10 | 61,10 (2.405) |

Ringlock is a range of robust circular connectors for industrial and transportation applications. It uses a metal bayonet coupling system for quick and reliable connections and thermoplastic bodies for low installed cost. The connectors are available in several sizes ranging from 4 to 48 circuits for signals of up to 16 A. With the addition of a cable clamp, the connectors can be water sealed to meet IP65. All Ringlock Circular Connectors are RoHS Compliant.



Applications:

- Industrial Electronics.
- Robotic Systems.
- Manufacturing Equipment.
- Printing Equipment.
- Instrumentation.
- Machine Building.

Product Features

- Rugged metal coupling.
- Available in unsealed and sealed versions.
- Positive bayonet locking.
- Shell to shell keying.
- Integrally molded combined plastic body and insulator.
- Wide range of accessories.
- Accepts all Trident signal contacts.
- PCB versions are available.
- Recognized under the component program of UL Inc.

Performance Specifications

| | |
|-------------------------------------|---|
| Operating Voltage ¹ | Up to 250 V ac rms Up to 380 V ac rms (Size 1807 only) |
| Contact Current Rating ² | Up to 13 A, Up to 16 A with High Conductivity Contacts |
| Operating Temperature | -55°C to +105°C (-67°F to + 221°F) |
| Insulation Resistance | 5000MW min. at 500 V dc |
| Durability ³ | Up to 500 Mating Cycles |
| Environmental Sealing | Up to IP65 |
| Flammability | UL 94 V-0 |

Materials and Finishes

| | |
|----------------------------------|----------------------------|
| Connector Body | Black Nylon |
| Coupling Ring | Nickel Plated Copper Alloy |
| Bayonet Pins | Stainless Steel |
| Bayonet Pins Support Band | Nickel Plated Copper Alloy |

¹ Depends on contacts used, layout and degree of pollution
² Depends on number and type of contacts used
³ Depends on plating and type of contact used

Test Specifications

The table below summarizes the results of key tests. Data is applicable to standard connectors with standard contacts. Variations may affect this data, so please consult factory for further information on your requirements.

| Test | Method | Criteria of Acceptance |
|--|---|---|
| Dielectric Withstanding Voltage | 1550 V ac for 60 seconds 2500 V ac for 60 seconds (Size 1807 only) | No breakdown No breakdown |
| Thermal Shock | -55°C to +125°C (-67°F to +257°F), 5 cycles | No physical damage. |
| Physical Shock | 50 g's peak, 3 axes, 11 millisecond duration half-sine pulse | No physical damage. No loss of continuity >1 sec |
| Vibration | 10 g's peak, 10-500 Hz, 9 hours | No physical damage. No loss of continuity >1 sec |
| Durability 500 cycles of mating and unmating, 500 mating cycles max | No mechanical or Electrical defects | |
| Salt Spray | 48 hours | Shall be capable of mating and unmating and meet contact resistance requirements |
| High Temperature Endurance | 1000 hours at 125°C (+257°F) | Insulation Resistance > 100 MΩ |
| Humidity Steady State | RH 90-95%, 40°C(+104°F), 504 hours | Insulation Resistance > 100 MΩ |
| Moisture Resistance | 10 Cycles | Insulation Resistance > 100 MΩ |

How to Order-Connectors

Typical Nomenclature: TR 16 19 P M S 1 N B



Contact Cavity Arrangements

Mating Face View, Standard Plug

(Mating Face View, Reversed Plug is mirror image)

Shell Size

Number of Contacts



Shell Size 10
4



Shell Size 12
8



Shell Size 14
12



Shell Size 16
19



Shell Size 18
7 (VDE 0110)*



Shell Size 18
23



Shell Size 20
28



Shell Size 22
35



Shell Size 24
48

* Meets creepage and clearance requirements according to VDE 0110.
 Note: The shell size indicates the diameter of the interface in sixteenths of an inch.
 Example: Shell size 16 is 1.00 inch in diameter, 25,4 mm.



Standard Plug
for Pin Contacts

- Mates with Standard Receptacles, see page 26.
- Accepts pin contacts, see page 60.
- Discriminating (Keying) Pins available, see page 68.
- Can be water sealed to IP65.

| Shell Size | Number of Contacts | Single Piece Connector | | Dimensions | | | | | Accessory Thread |
|------------|--------------------|------------------------|--------------|---------------------------------|---------------|---------------------------------|---------------------------------|----------------------------------|------------------|
| | | Part Number | Nomenclature | $\varnothing A \pm 0,20 (.008)$ | B max. | $\varnothing C \pm 0,15 (.005)$ | $\varnothing D \pm 0,15 (.005)$ | E | |
| 10 | 4 | 192922-1250 | TR1004PMS1NB | 21,60 (.850) | 31,80 (1.252) | 10,90 (.429) | 12,20 (.480) | 19,10 $\pm 0,20 (.751 \pm .007)$ | 9/16 - 24 UNEF |
| 12 | 8 | 192922-1260 | TR1208PMS1NB | 24,80 (.976) | 31,80 (1.252) | 13,80 (.543) | 15,10 (.594) | 19,10 $\pm 0,20 (.751 \pm .007)$ | 11/16 - 24 UNEF |
| 14 | 12 | 192922-1270 | TR1412PMS1NB | 28,00 (1.102) | 31,80 (1.252) | 17,00 (.669) | 18,30 (.720) | 19,10 $\pm 0,20 (.751 \pm .007)$ | 13/16 - 20 UNEF |
| 16 | 19 | 192922-1280 | TR1619PMS1NB | 31,20 (1.228) | 31,80 (1.252) | 19,90 (.783) | 21,40 (.842) | 19,10 $\pm 0,20 (.751 \pm .007)$ | 15/16 - 20 UNEF |
| 18 | 7 | 192990-1330 | TR1807PMS1NB | 34,30 (1.350) | 33,00 (1.299) | 22,50 (.885) | 24,00 (.944) | 19,10 $\pm 0,20 (.751 \pm .007)$ | 1-1/16 - 18 UNEF |
| 18 | 23 | 192990-1320 | TR1823PMS1NB | 34,30 (1.350) | 31,80 (1.252) | 22,40 (.881) | 24,00 (.944) | 19,10 $\pm 0,20 (.751 \pm .007)$ | 1-1/16 - 18 UNEF |
| 20 | 28 | 192922-1290 | TR2028PMS1NB | 37,50 (1.476) | 31,80 (1.252) | 25,60 (1.007) | 27,10 (1.066) | 19,10 $\pm 0,20 (.751 \pm .007)$ | 1-3/16 - 18 UNEF |
| 22 | 35 | 192922-1300 | TR2235PMS1NB | 40,70 (1.602) | 31,80 (1.252) | 28,50 (1.122) | 30,40 (1.196) | 19,10 $\pm 0,20 (.751 \pm .007)$ | 1-5/16 - 18 UNEF |
| 24 | 48 | 192990-1340 | TR2448PMS1NB | 43,90 (1.728) | 31,80 (1.252) | 31,70 (1.248) | 33,50 (1.318) | 14,72 $\pm 0,15 (.580 \pm .006)$ | 1-7/16 - 18 UNEF |

Note: For versions with plastic locking ring, please consult the factory.

IMPORTANT NOTE: Standard and Reversed Format
Equipment design dictates whether the fixed connector is "live" or "dead" when disconnected. Connector housings are available that provide socket contacts on the live side of the equipment.

Standard Format: Receptacle with socket contacts.
Reversed Format: Receptacle with pin contacts.

Standard and Reversed connectors are not intermateable.



Standard Receptacle for Socket Contacts

ØJ=Flange in Front of Panel
ØH= Flange at Rear of Panel

- Mates with Standard Plugs, see page 25.
- Accepts socket contacts, see page 60.
- Printed circuit contacts are available, see page 60.

Dimensions

| Shell Size | Number of Contacts | A max. | B ± 0,15 (.005) | C ± 0,20 (.007) | ØD ± 0,15 (.005) | E ± 0,15 (.005) | F ± 0,25 (.009) | ØG ± 0,10 (.003) | ØH ± 0,10 (.003) | ØJ ± 0,10 (.003) | Accessory Thread |
|------------|--------------------|---------------|-----------------|-----------------|------------------|-----------------|-----------------|------------------|------------------|------------------|------------------|
| 10 | 4 | 24,00 (.945) | 2,30 (.091) | 11,15 (.439) | 15,00 (.591) | 18,00 (.709) | 23,50 (.925) | 3,25 (.128) | 17,30 (.681) | 15,10 (.594) | 9/16 - 24 UNEF |
| 12 | 8 | 25,80 (1.016) | 2,30 (.091) | 11,35 (.447) | 19,00 (.748) | 20,50 (.807) | 26,20 (1.031) | 3,25 (.128) | 21,80 (.858) | 18,20 (.716) | 11/16 - 24 UNEF |
| 14 | 12 | 24,00 (.945) | 2,30 (.091) | 11,35 (.447) | 22,20 (.874) | 22,60 (.890) | 28,15 (1.108) | 3,25 (.128) | 25,00 (.984) | 21,40 (.842) | 13/16 - 20 UNEF |
| 16 | 19 | 25,80 (1.016) | 2,30 (.091) | 11,35 (.447) | 25,40 (1.000) | 24,20 (.953) | 30,50 (1.200) | 3,25 (.128) | 28,10 (1.106) | 24,60 (.968) | 15/16 - 20 UNEF |
| 18 | 7 | 32,50 (1.280) | 2,50 (.098) | 18,20 (.716) | 28,50 (1.122) | 27,00 (1.063) | 33,30 (1.311) | 3,25 (.128) | 31,30 (1.232) | 27,80 (1.094) | 1-1/16 - 18 UNEF |
| 18 | 23 | 25,80 (1.016) | 2,50 (.098) | 11,35 (.447) | 28,50 (1.122) | 26,90 (1.059) | 33,30 (1.311) | 3,25 (.128) | 31,30 (1.232) | 27,80 (1.094) | 1-1/16 - 18 UNEF |
| 20 | 28 | 27,00 (1.063) | 2,50 (.098) | 14,50 (.571) | 31,70 (1.248) | 29,20 (1.150) | 36,50 (1.437) | 3,25 (.128) | 34,50 (1.358) | 30,90 (1.216) | 1-3/16 - 18 UNEF |
| 22 | 35 | 28,00 (1.102) | 3,50 (.138) | 14,50 (.571) | 34,90 (1.374) | 31,60 (1.244) | 39,70 (1.563) | 3,25 (.128) | 37,70 (1.484) | 34,10 (1.342) | 1-5/16 - 18 UNEF |
| 24 | 48 | 30,30 (1.193) | 3,50 (.138) | 15,30 (.602) | 38,05 (1.498) | 34,45 (1.356) | 42,90 (1.689) | 3,90 (.154) | 40,90 (1.610) | 37,30 (1.468) | 1-7/16 - 18 UNEF |

Part Numbers-Single Piece Connector

| Shell Size | Number of Contacts | Unsealed | | Sealed (see important note below) | |
|------------|--------------------|-------------|--------------|-----------------------------------|--------------|
| | | Part Number | Nomenclature | Part Number | Nomenclature |
| 10 | 4 | 192922-1190 | TR1004RFS1NB | 192990-1660 | TR1004RFH1NB |
| 12 | 8 | 192922-1200 | TR1208RFS1NB | 192990-1670 | TR1208RFH1NB |
| 14 | 12 | 192922-1210 | TR1412RFS1NB | 192990-1680 | TR1412RFH1NB |
| 16 | 19 | 192922-1220 | TR1619RFS1NB | 192990-1690 | TR1619RFH1NB |
| 18 | 7 | 192990-1300 | TR1807RFS1NB | 192990-1700 | TR1807RFH1NB |
| 18 | 23 | 192990-1290 | TR1823RFS1NB | 192990-1710 | TR1823RFH1NB |
| 20 | 28 | 192922-1230 | TR2028RFS1NB | 192990-1720 | TR2028RFH1NB |
| 22 | 35 | 192922-1240 | TR2235RFS1NB | 192990-1730 | TR2235RFH1NB |
| 24 | 48 | 192990-1310 | TR2448RFS1NB | 192990-1740 | TR2448RFH1NB |

IMPORTANT NOTE: Sealed Connectors

A sealed receptacle has an O-Ring seal that blocks moisture when the plug and receptacle are mated. However, the receptacle is not sealed in an unmated condition. For protection, dust caps are recommended for unmated receptacles, see page 34.

Plug connectors using a sealed cable clamp (see page 35) with jacketed cable will meet IP65 when mated to a sealed receptacle.





Reversed Plug
for Socket Contacts

- Mates with Reversed Receptacles, see page 28.
- Accepts socket contacts, see page 60.
- Discriminating (Keying) Pins available, see page 69.
- Can be water sealed to IP65.

| Shell Size | Number of Contacts | Single Piece Connector | | Dimensions | | | | | Accessory Thread |
|------------|--------------------|------------------------|--------------|------------------|---------------|------------------|------------------|--------------------------|------------------|
| | | Part Number | Nomenclature | ØA ± 0,20 (.008) | B max. | ØC ± 0,15 (.005) | ØD ± 0,15 (.005) | E | |
| 10 | 4 | 192926-0500 | TR1004PFS1NB | 21,60 (.850) | 26,10 (1.027) | 11,00 (.433) | 12,20 (.480) | 19,10 ±0,20 (.751 ±.007) | 9/16 - 24 UNEF |
| 12 | 8 | 192926-0510 | TR1208PFS1NB | 24,80 (.976) | 25,60 (1.008) | 13,90 (.547) | 15,10 (.594) | 19,10 ±0,20 (.751 ±.007) | 11/16 - 24 UNEF |
| 14 | 12 | 192926-0520 | TR1412PFS1NB | 28,00 (1.102) | 26,80 (1.055) | 17,10 (.673) | 18,30 (.720) | 19,10 ±0,20 (.751 ±.007) | 13/16 - 20 UNEF |
| 16 | 19 | 192926-0530 | TR1619PFS1NB | 31,20 (1.228) | 27,60 (1.087) | 20,00 (.787) | 21,40 (.842) | 19,10 ±0,20 (.751 ±.007) | 15/16 - 20 UNEF |
| 18 | 7 | 192990-1390 | TR1807PFS1NB | 34,30 (1.350) | 31,50 (1.240) | 22,50 (.885) | 24,00 (.944) | 19,10 ±0,20 (.751 ±.007) | 1-1/16 - 18 UNEF |
| 18 | 23 | 192990-1380 | TR1823PFS1NB | 34,30 (1.350) | 25,60 (1.088) | 22,50 (.885) | 24,00 (.944) | 19,10 ±0,20 (.751 ±.007) | 1-1/16 - 18 UNEF |
| 20 | 28 | 192926-0540 | TR2028PFS1NB | 37,50 (1.476) | 31,30 (1.232) | 25,70 (1.011) | 27,10 (1.066) | 19,10 ±0,20 (.751 ±.007) | 1-3/16 - 18 UNEF |
| 22 | 35 | 192926-0550 | TR2235PFS1NB | 40,70 (1.602) | 31,30 (1.232) | 28,60 (1.126) | 30,40 (1.196) | 19,10 ±0,20 (.751 ±.007) | 1-5/16 - 18 UNEF |
| 24 | 48 | 192990-1400 | TR2448PFS1NB | 43,90 (1.728) | 31,30 (1.232) | 31,80 (1.225) | 33,50 (1.318) | 14,72 ±0,15 (.580 ±.006) | 1-7/16 - 18 UNEF |

Note: For versions with plastic locking ring, please consult the factory.

IMPORTANT NOTE: Standard and Reversed Format

Equipment design dictates whether the fixed connector is “live” or “dead” when disconnected. Connector housings are available that provide socket contacts on the live side of the equipment.

Standard Format: Receptacle with socket contacts.

Reversed Format: Receptacle with pin contacts.

Standard and Reversed connectors are not intermateable.



Reversed Receptacle for Pin Contacts

- Mates with Reversed Plugs, see page 27.
- Accepts pin contacts, see page 60.
- Printed Circuit contacts are available, see page 60.



Panel Cutout

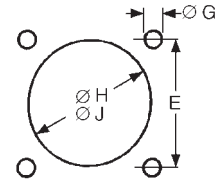

ØJ = Flange in Front of Panel
 ØH = Flange at Rear of Panel

Dimensions

| Shell Size | Number of Contacts | A max. | B ±0,15 (.005) | C ±0,20 (.007) | ØD ±0,15 (.005) | E ±0,15 (.005) | F ±0,25 (.009) | ØG ±0,10 (.003) | ØH ±0,10 (.003) | ØJ ±0,10 (.003) | Accessory Thread |
|------------|--------------------|---------------|----------------|----------------|-----------------|----------------|----------------|-----------------|-----------------|-----------------|------------------|
| 10 | 4 | 31,50 (1.240) | 2,30 (.091) | 11,35 (.447) | 15,00 (.591) | 18,00 (.709) | 23,50 (.925) | 3,25 (.128) | 17,30 (.681) | 15,10 (.594) | 9/16 - 24 UNEF |
| 12 | 8 | 31,50 (1.240) | 2,30 (.091) | 11,35 (.447) | 19,00 (.748) | 20,50 (.807) | 26,20 (1.031) | 3,25 (.128) | 21,80 (.858) | 18,20 (.716) | 11/16 - 24 UNEF |
| 14 | 12 | 31,50 (1.240) | 2,30 (.091) | 11,35 (.447) | 22,20 (.874) | 22,90 (.902) | 28,15 (1.108) | 3,25 (.128) | 25,00 (.984) | 21,40 (.842) | 13/16 - 20 UNEF |
| 16 | 19 | 31,50 (1.240) | 2,30 (.091) | 11,35 (.447) | 25,40 (1.000) | 24,20 (.953) | 30,50 (1.200) | 3,25 (.128) | 28,10 (1.106) | 24,60 (.968) | 15/16 - 20 UNEF |
| 18 | 7 | 34,20 (1.346) | 2,30 (.091) | 17,80 (.700) | 28,50 (1.122) | 27,00 (1.063) | 33,30 (1.311) | 3,25 (.128) | 31,30 (1.232) | 27,80 (1.094) | 1-1/16 - 18 UNEF |
| 18 | 23 | 31,50 (1.240) | 2,50 (.098) | 11,35 (.447) | 28,50 (1.122) | 26,90 (1.059) | 33,30 (1.311) | 3,25 (.128) | 31,30 (1.232) | 27,80 (1.094) | 1-1/16 - 18 UNEF |
| 20 | 28 | 33,00 (1.299) | 2,50 (.098) | 14,55 (.573) | 31,70 (1.248) | 29,20 (1.150) | 36,50 (1.437) | 3,25 (.128) | 34,50 (1.358) | 30,90 (1.216) | 1-3/16 - 18 UNEF |
| 22 | 35 | 33,00 (1.299) | 3,50 (.138) | 14,55 (.573) | 34,90 (1.374) | 31,60 (1.244) | 39,70 (1.563) | 3,25 (.128) | 37,70 (1.484) | 34,10 (1.342) | 1-5/16 - 18 UNEF |
| 24 | 48 | 34,80 (1.370) | 3,50 (.138) | 15,35 (.604) | 38,05 (1.498) | 34,45 (1.356) | 42,90 (1.689) | 3,90 (.154) | 40,90 (1.610) | 37,30 (1.468) | 1-7/16 - 18 UNEF |

Part Numbers - Single Piece Connector

| Shell Size | Number of Contacts | Unsealed | | Sealed (see important note below) | |
|------------|--------------------|-------------|--------------|-----------------------------------|--------------|
| | | Part Number | Nomenclature | Part Number | Nomenclature |
| 10 | 4 | 192926-0440 | TR1004RMS1NB | 192990-1760 | TR1004RMH1NB |
| 12 | 8 | 192926-0450 | TR1208RMS1NB | 192990-1770 | TR1208RMH1NB |
| 14 | 12 | 192926-0460 | TR1412RMS1NB | 192990-1780 | TR1412RMH1NB |
| 16 | 19 | 192926-0470 | TR1619RMS1NB | 192990-1790 | TR1619RMH1NB |
| 18 | 7 | 192990-1360 | TR1807RMS1NB | 192990-1800 | TR1807RMH1NB |
| 18 | 23 | 192990-1350 | TR1823RMS1NB | 192990-1810 | TR1823RMH1NB |
| 20 | 28 | 192926-0480 | TR2028RMS1NB | 192990-1820 | TR2028RMH1NB |
| 22 | 35 | 192926-0490 | TR2235RMS1NB | 192990-1830 | TR2235RMH1NB |
| 24 | 48 | 192990-1370 | TR2448RMS1NB | 192990-1840 | TR2448RMH1NB |

IMPORTANT NOTE: Sealed Connectors

A sealed receptacle has an O-Ring seal that blocks moisture when the plug and receptacle are mated. However, the receptacle is not sealed in an unmated condition. For protection, dust caps are recommended for unmated receptacles, see page 34.

Plug connectors using a sealed cable clamp (see page 35) with jacketed cable will meet IP65 when mated to a sealed receptacle.



How to Order-Accessories

Typical Nomenclature:

TR 10 A HC 1 N

Series

TR = Trident Ringlock

Shell Size

- 10
- 12
- 14
- 16
- 18
- 20
- 22
- 24

A = Accessory

N = Nylon

Series Identification

1 = Standard

HC = Sealed Cable Clamp

SR = Unsealed Cable Clamp

AD = Heat Shrink Adapter

How to Order-Dust Caps

Typical Nomenclature:

TNA 10 DCR0 - 00 B

Material

Series

TNA = Trident Neptune Accessory
(Ringlock Compatible)

Shell Size

- 10
- 12
- 14
- 16
- 18
- 20
- 22
- 24

Packaging

B = Bulk

L = Single Pack

Accessory Style, Type and Size

| | | |
|----------|-------|--------------------------------------|
| Dust Cap | | |
| DC | R0-00 | Unsealed Dust Cap, Receptacle (PAD)* |



Unsealed Plastic Dust Caps for Receptacles

- Protects unmated receptacles.
- Durable construction for long-term use.
- For use with Ringlock receptacles.

| Shell Size | Part Number (Each) | Part Number (Pack of 100) | Dimension Ø A max. |
|------------|--------------------|---------------------------|--------------------|
| 10 | 192900-0666 | 192900-0676 | 21,80 (.858) |
| 12 | 192900-0667 | 192900-0677 | 25,40 (1.000) |
| 14 | 192900-0668 | 192900-0678 | 28,60 (1.126) |
| 16 | 192900-0669 | 192900-0679 | 31,70 (1.248) |
| 18 | 192900-0670 | 192900-0680 | 34,90 (1.374) |
| 20 | 192900-0671 | 192900-0681 | 38,10 (1.500) |
| 22 | 192900-0672 | 192900-0682 | 41,20 (1.622) |
| 24 | 192900-0673 | 192900-0683 | 44,40 (1.748) |



Adapters for Heat Shrink Boots or Sleeving

| Shell Size | Part Number (Each) | Nomenclature | Dimensions | | | |
|------------|--------------------|--------------|----------------|----------------|---------------|---------------------|
| | | | ØA ±0,3 (.012) | ØB ±0,3 (.012) | C ±0,3 (.012) | H Thread |
| 10 | 192990-1430 | TR10AAD | 21,00 (.827) | 18,10 (.712) | 19,20 (.755) | 9/16 - 24 UNEF-2B |
| 12 | 192990-1440 | TR12AAD | 24,00 (.944) | 23,40 (.921) | 19,20 (.755) | 11/16 - 24 UNEF-2B |
| 14 | 192990-1450 | TR14AAD | 27,00 (1.063) | 24,20 (.952) | 19,20 (.755) | 13/16 - 20 UNEF-2B |
| 16 | 192990-1460 | TR16AAD | 30,20 (1.189) | 29,60 (1.165) | 21,50 (.846) | 15/16 - 20 UNEF-2B |
| 18 | 192990-1470 | TR18AAD | 33,30 (1.311) | 31,70 (1.248) | 21,50 (.846) | 1-1/16 - 18 UNEF-2B |
| 20 | 192990-1480 | TR20AAD | 36,50 (1.437) | 35,80 (1.409) | 22,80 (.897) | 1-3/16 - 18 UNEF-2B |
| 22 | 192990-1490 | TR22AAD | 39,70 (1.563) | 38,20 (1.503) | 22,80 (.897) | 1-5/16 - 18 UNEF-2B |
| 24 | 192990-1500 | TR24AAD | 42,90 (1.689) | 41,30 (1.626) | 21,90 (.862) | 1-7/16 - 18 UNEF-2B |



Panel Gaskets for Ringlock Receptacles

- For sealed versions

| Shell Size | Part Number (Pack of 100) |
|------------|---------------------------|
| 10 | 075-8543-011 |
| 12 | 075-8543-012 |
| 14 | 075-8543-013 |
| 16 | 075-8543-014 |
| 18 | 075-8543-015 |
| 20 | 075-8543-016 |
| 22 | 075-8543-017 |
| 24 | 075-8543-018 |



**Sealed Cable Clamps
for Use With Ringlock Circular Connectors**

- For use with jacketed cables.
- Provides strain relief and wire protection.
- Can be water sealed to IP65. See notes on pages 26 and 28.
- For assembly instructions, see page 75.

* For disassembly, add 9,00 (.354) for Shell Sizes 10-16 & add 10,60 (.417) for Shell Sizes 18-24.

| Shell Size | Part Number (Each) | Nomenclature | Dimensions | | |
|------------|-----------------------|--------------|---------------|-----------------|----------------|
| | | | Ø A max. | B ± 0,20 (.007) | C* max. |
| 10 | 192990-1530 | TR10AHC1N | 11,10 (.437) | 18,80 (.740) | 76,50 (3.011) |
| 12 | 192990-1540 | TR12AHC1N | 13,60 (.535) | 20,80 (.818) | 77,80 (3.063) |
| 14 | 192990-1550 | TR14AHC1N | 14,60 (.574) | 22,80 (.897) | 85,50 (3.366) |
| 16 | 192990-1560 | TR16AHC1N | 16,60 (.653) | 24,70 (.972) | 89,80 (3.535) |
| 18 | 192990-1570 | TR18AHC1N | 16,60 (.653) | 24,70 (.972) | 93,00 (3.661) |
| 20 | 192990-1580 | TR20AHC1N | 22,10 (.870) | 31,80 (1.252) | 107,50 (4.232) |
| 22 | 192990-1590 | TR22AHC1N | 22,10 (.870) | 31,80 (1.252) | 114,50 (4.507) |
| 24 | 192990-1600 | TR24AHC1N | 29,60 (1.165) | 41,80 (1.645) | 128,50 (5.059) |

* Assumes a uniformly cylindrical cable. Variations in the diameter could effect sealing.



* For disassembly, add 9,00 (.354) for Shell Sizes 10-16 & add 10,60 (.417) for Shell Sizes 18-24.

**Unsealed Cable Clamps
for Use With Ringlock Circular Connectors**

- Provides strain relief and wire protection.
- For assembly instructions, see page 79.

| Shell Size | Part Number (Each) | Nomenclature | Dimensions | | | | |
|------------|-----------------------|--------------|---------------|-----------------|---------------|-------------------|---------------|
| | | | Ø A max. | B ± 0,15 (.005) | Ø C max. | Ø D ± 0,15 (.005) | E* max. |
| 10 | 192922-1310 | TR10ASR1N | 21,50 (.846) | 6,40 (.251) | 8,70 (.342) | 21,00 (.826) | 61,30 (2.413) |
| 12 | 192922-1320 | TR12ASR1N | 24,90 (.980) | 6,40 (.251) | 12,80 (.503) | 24,00 (.944) | 61,30 (2.413) |
| 14 | 192922-1330 | TR14ASR1N | 27,00 (1.063) | 6,40 (.251) | 13,80 (.543) | 27,00 (1.063) | 67,10 (2.641) |
| 16 | 192922-1340 | TR16ASR1N | 30,10 (1.185) | 6,40 (.251) | 17,00 (.669) | 30,20 (1.189) | 67,10 (2.641) |
| 18 | 192990-1510 | TR18ASR1N | 32,00 (1.259) | 7,00 (.275) | 19,90 (.783) | 33,20 (1.307) | 70,80 (2.787) |
| 20 | 192922-1350 | TR20ASR1N | 34,30 (1.350) | 7,00 (.275) | 21,00 (.827) | 36,40 (1.433) | 79,30 (3.122) |
| 22 | 192922-1360 | TR22ASR1N | 37,10 (1.460) | 8,20 (.322) | 23,00 (.905) | 39,60 (1.559) | 85,30 (3.358) |
| 24 | 192990-1520 | TR24ASR1N | 41,80 (1.645) | 8,20 (.322) | 27,00 (1.063) | 42,80 (1.685) | 90,80 (3.574) |

Dimensions shown in mm (inch)
Specifications and dimensions subject to change

Neptune is a range of circular connectors specifically designed for harsh environment applications. They come with membrane wire seals that meet the requirements for IP67 and do not require blanking plugs for unused cavities. They will accept various combinations of signal (13 A) and power (30 A) contacts. The receptacle connectors feature stainless steel bayonet pins integrally molded into the bodies. The plug connectors are available with either high strength metal or corrosion resistant plastic coupling rings. All Neptune Circular Connectors are RoHS Compliant.



Applications

- Off Road Vehicles.
- Truck and Bus.
- Agricultural Equipment.
- Construction Equipment.
- Printing Machines.
- Industrial Automation.
- Stamping Machines.

Product Features

- Mixes signal and 30 A power contacts in one housing.
- Printed circuit contacts available.
- Full interface and cable sealing up to IP67.
- Large range of support accessories.
- Robust, cost effective connector for harsh environments.

Performance Specifications

| | |
|-------------------------------------|--|
| Operating Voltage ¹ | Up to 250 V ac rms |
| Contact Current Rating ² | Up to 13 A, Up to 16 A with High Conductivity Contacts, Up to 30 A with Power Contacts |
| Operating Temperature | -55°C to + 105°C (-67°F to +221°F) |
| Insulation Resistance | 5000MW min. at 500 V dc |
| Durability ³ | Up to 500 Mating Cycles |
| Environmental Sealing | Up to IP67 |
| Flammability | UL 94 V-0 |

¹ Depends on contacts used, layout, and degree of pollution
² Depends on type and number of contacts used
³ Depends on plating and type of contacts used

Materials and Finishes

| | |
|---------------------------|----------------------------|
| Connector Body | Black Nylon |
| Coupling Ring | Nickel Plated Copper Alloy |
| Bayonet Pins | Stainless Steel |
| Bayonet Pins Support Band | Nickel Plated Copper Alloy |

Test Specifications

The table below summarizes the results of key tests. Data is applicable to standard connectors with standard contacts. Variations may affect this data, so please consult factory for further information on your requirements.

| Test | Method | Criteria of Acceptance |
|---------------------------------|--|--|
| Dielectric Withstanding Voltage | 2000 V ac for 60 seconds | No breakdown |
| Thermal Shock | -55°C to +120°C (-67°F to +248°F) | No physical damage |
| Physical Shock | 40 g's peak, 3 axes, 6 millisecond duration half-sine pulse | No physical damage. No loss of continuity >10 sec |
| Vibration | 10 g's peak, 10-500 Hz | No physical damage, No loss of continuity >10 sec |
| Durability | 500 cycles of mating and unmating, 500 mating cycles max | No mechanical or electrical defects |
| Salt Spray | 48 hours | Shall be capable of mating and unmating and meet contact resistance requirements |
| High Temperature Endurance | 1000 hours at 85°C (+185°F) 250 hours at 120°C (+248°F) | Insulation Resistance > 100 MW |
| Humidity Steady State | RH 90-95%, 40°C (+104°F), 504 hours | Insulation Resistance > 100 MW |

How to Order-Connectors

Typical Nomenclature: **TN 7 S 24 - 1219 P 1 B 01**

Series

TN = Trident Neptune

Shell Style

- 0 = Flange Receptacle (4 holes)
- 6 = Plug
- 7 = Jam Nut Receptacle

Sealing Class

- G = Grommet, no nut
- LS = Large Grommet, extender and nut (*Size 24-0048 only*)
- S = With Grommet and nut
- U = Unsealed

Modification

- * = Standard
- 01 = Jam Nut Receptacles bulk packages are delivered without nut
- See page 50 for Spare Jam Nuts

Packaging

- B = Bulk (100 pcs)
- L = Single Pack

Connector Finish Materials

- 1 = Standard (Nickel Plated Metal Parts)
- 2 = Plastic Coupling Nut (*TN plug shell sizes 16 and 24 only*)

Contact Type

- P = Pin
- S = Socket

| Shell Size | | Number of Power Contacts | Number of Signal Contacts |
|------------|---|--------------------------|---------------------------|
| 14 | - | 00 | 12 |
| 16 | - | 00 | 19 |
| 16 | - | 02 | 13 |
| 24 | - | 12 | 19 |
| 24 | - | 04 | 20 |
| 24 | - | 04 | 28 |
| 24 | - | 00 | 48 |

Dimensions shown in mm (inch)
Specifications and dimensions subject to change



Contact Cavity Arrangements

Neptune Circular Connectors offer combinations of Signal and Power contacts. The Signal cavities will accept any of the standard Trident contacts, including signal contacts up to 16 A. The power cavities will accept power contacts rated at 30 A. PCB contacts are also available, for more information, see page 60.

Mating Face Views of Reversed and Standard Receptacles.

Shell Size

Number of Power Contacts

Number of Signal Contacts



Shell Size 14
0 Power
12 Signal



Shell Size 16
0 Power
19 Signal



Shell Size 16
2 Power
13 Signal

The view is of reversed receptacle
Standard receptacle is a mirror image

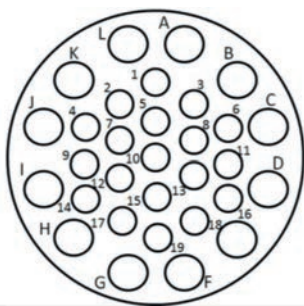

Shell Size 24
12 Power
19 Signal

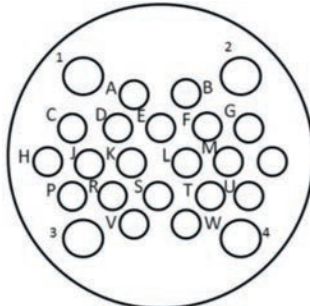

Shell Size 24
4 Power
20 Signal

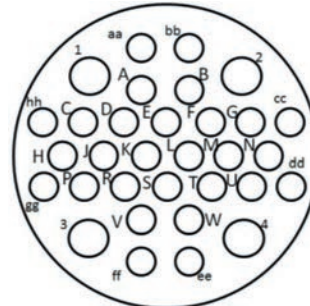

Shell Size 24
4 Power
28 Signal

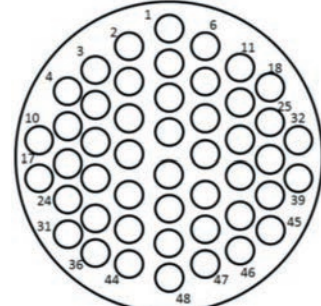

Shell Size 24
0 Power
48 Signal

Note: The Signal cavities will accept any of the standard Trident contacts, including signal contacts up to 16 A. The power cavities will accept power contacts rated at 30 A. PCB contacts are also available.

Wire Sealing Range*

| Contact Arrangement (Power- Signal Contacts) | Signal (Overall Diameter) | Power (Overall Diameter) |
|---|------------------------------|-----------------------------|
| 0-12 | 1,70-2,70 (.066-.106) | N/A |
| 0-19 | 1,70-2,70 (.066-.106) | N/A |
| 2-13 | 1,70-2,70 (.066-.106) | 2,70-4,00 (.106-.157) |
| 4-20 | 1,70-2,70 (.066-.106) | 2,70-4,00 (.106-.157) |
| 4-28 | 1,70-2,70 (.066-.106) | 2,70-4,00 (.106-.157) |
| 0-48 | 1,70-2,20 (.066-.086) | N/A |
| 0-48 (L) | 2,60-3,20 (.102-.126) | N/A |
| 12-19 | 1,70-2,70 (.066-.106) | 2,70-4,00 (.106-.157) |

(L) Larger overall sealing diameter for thick insulation wires
* Describes the range of cable diameters to be used respective layout





Standard Plug
for Pin Contacts
Metal Locking Ring

- For Wire Sealing Ranges, see page 34.
- Accepts pin contacts, see page 60.
- Water sealed to IP67.

With Wire Seal and Securing Nut

| Shell Size | Contact Layout | | Single Piece Connector | | Bulk Packages (100 Connectors) | | A | ØB | ØC | D |
|------------|----------------|-----------------|------------------------|-----------------|--------------------------------|-----------------|---------------|---------------|---------------|--------------------------|
| | Power Contacts | Signal Contacts | Part Number | Nomenclature | Part Number | Nomenclature | | | | |
| 14 | 00 | 12 | 192900-0303 | TN6S14-0012P1L | 192900-0318 | TN6S14-0012P1B | 38,80 (1.527) | 24,30 (.957) | 28,00 (1.102) | 19,10 ±0,20 (.751 ±.007) |
| 16 | 00 | 19 | 192900-0017 | TN6S16-0019P1L | 192900-0013 | TN6S16-0019P1B | 38,90 (1.532) | 27,00 (1.063) | 30,20 (1.189) | 19,10 ±0,20 (.751 ±.007) |
| 16 | 02 | 13 | 192900-0507 | TN6S16-0213P1L | 192900-0510 | TN6S16-0213P1B | 38,90 (1.532) | 27,00 (1.063) | 30,20 (1.189) | 19,10 ±0,20 (.751 ±.007) |
| 24 | 00 | 48 | 192900-0469 | TN6S24-0048P1L | 192900-0472 | TN6S24-0048P1B | 39,80 (1.566) | 40,50 (1.594) | 44,00 (1.732) | 14,72 ±0,15 (.580 ±.006) |
| 24 | 04 | 20 | 192900-0014 | TN6S24-0420P1L | 192990-9430 | TN6S24-0420P1B | 39,80 (1.566) | 40,50 (1.594) | 44,00 (1.732) | 14,72 ±0,15 (.580 ±.006) |
| 24 | 04 | 28 | 192900-0015 | TN6S24-0428P1L | 192900-0012 | TN6S24-0428P1B | 39,80 (1.566) | 40,50 (1.594) | 44,00 (1.732) | 14,72 ±0,15 (.580 ±.006) |
| 24 | 12 | 19 | 192900-0016 | TN6S24-1219P1L | 192990-9380 | TN6S24-1219P1B | 39,80 (1.566) | 40,50 (1.594) | 44,00 (1.732) | 14,72 ±0,15 (.580 ±.006) |
| 24 | 00 | 48 (L) | 192991-0628 | TN6LS24-0048P1L | 192991-0637 | TN6LS24-0048P1B | 50,70 (2.000) | 40,50 (1.594) | 44,00 (1.732) | 14,72 ±0,15 (.580 ±.006) |

Without Securing Nut

| Shell Size | Contact Layout | | Single Piece Connector | | Bulk Packages (100 Connectors) | | A | ØB | ØC | D |
|------------|----------------|-----------------|------------------------|----------------|--------------------------------|----------------|---|------------------|---------------|--------------------------|
| | Power Contacts | Signal Contacts | Part Number | Nomenclature | Part Number | Nomenclature | | | | |
| 14 | 00 | 12 | * | TN6G14-0012P1L | 192900-0319 | TN6G14-0012P1B | - | 13/16 – 20 UNEF | 28,00 (1.102) | 19,10 ±0,20 (.751 ±.007) |
| 16 | 00 | 19 | * | TN6G16-0019P1L | 192900-0095 | TN6G16-0019P1B | - | 15/16 – 20 UNEF | 30,20 (1.189) | 19,10 ±0,20 (.751 ±.007) |
| 24 | 00 | 48 | * | TN6G24-0048P1L | 192900-0473 | TN6G24-0048P1B | - | 1-7/16 – 18 UNEF | 44,00 (1.732) | 14,72 ±0,15 (.580 ±.006) |
| 24 | 04 | 20 | * | TN6G24-0420P1L | 192900-0092 | TN6G24-0420P1B | - | 1-7/16 – 18 UNEF | 44,00 (1.732) | 14,72 ±0,15 (.580 ±.006) |
| 24 | 04 | 28 | * | TN6G24-0428P1L | 192990-0093 | TN6G24-0428P1B | - | 1-7/16 – 18 UNEF | 44,00 (1.732) | 14,72 ±0,15 (.580 ±.006) |
| 24 | 12 | 19 | * | TN6G24-1219P1L | 192900-0094 | TN6G24-1219P1B | - | 1-7/16 – 18 UNEF | 44,00 (1.732) | 14,72 ±0,15 (.580 ±.006) |

Unsealed - Without Wire Seal and Securing Nut

| Shell Size | Contact Layout | | Single Piece Connector | | Bulk Packages (100 Connectors) | | A | ØB | ØC | D |
|------------|----------------|-----------------|------------------------|----------------|--------------------------------|----------------|---------------|------------------|---------------|--------------------------|
| | Power Contacts | Signal Contacts | Part Number | Nomenclature | Part Number | Nomenclature | | | | |
| 16 | 02 | 13 | * | TN6U16-0213P1L | * | TN6U16-0213P1B | 34,70 (1.366) | 15/16 – 20 UNEF | 30,20 (1.189) | 19,10 ±0,20 (.751 ±.007) |
| 24 | 04 | 20 | * | TN6U24-0420P1L | * | TN6U24-0420P1B | 35,70 (1.406) | 1-7/16 – 18 UNEF | 44,00 (1.732) | 14,72 ±0,15 (.580 ±.006) |
| 24 | 04 | 28 | * | TN6U24-0428P1L | * | TN6U24-0428P1B | 35,70 (1.406) | 1-7/16 – 18 UNEF | 44,00 (1.732) | 14,72 ±0,15 (.580 ±.006) |
| 24 | 12 | 19 | * | TN6U24-1219P1L | * | TN6U24-1219P1B | 35,70 (1.406) | 1-7/16 – 18 UNEF | 44,00 (1.732) | 14,72 ±0,15 (.580 ±.006) |

* For details please consult the factory



Standard Plug
for Pin Contacts
Plastic Locking Ring

- For Wire Sealing Ranges, see page 34.
- Accepts pin contacts, see page 60.
- Water sealed to IP67.

With Wire Seal and Securing Nut

| Shell Size | Contact Layout | | Single Piece Connector | | Bulk Packages (100 Connectors) | | A | ØB | ØC |
|------------|----------------|-----------------|------------------------|-----------------|--------------------------------|-----------------|---------------|---------------|---------------|
| | Power Contacts | Signal Contacts | Part Number | Nomenclature | Part Number | Nomenclature | | | |
| 16 | 00 | 19 | 192900-0557 | TN6S16-0019P2L | * | TN6S16-0019P2B | 38,90 (1.532) | 27,00 (1.063) | 32,80 (1.291) |
| 16 | 02 | 13 | 192900-0561 | TN6S16-0213P2L | * | TN6S16-0213P2B | 38,90 (1.532) | 27,00 (1.063) | 32,80 (1.291) |
| 24 | 00 | 48 | 192900-0539 | TN6S24-0048P2L | * | TN6S24-0048P2B | 39,80 (1.566) | 40,50 (1.594) | 45,75 (1.800) |
| 24 | 04 | 20 | 192900-0537 | TN6S24-0420P2L | * | TN6S24-0420P2B | 39,80 (1.566) | 40,50 (1.594) | 45,75 (1.800) |
| 24 | 04 | 28 | 192900-0549 | TN6S24-0428P2L | 192900-0551 | TN6S24-0428P2B | 39,80 (1.566) | 40,50 (1.594) | 45,75 (1.800) |
| 24 | 12 | 19 | 192900-0538 | TN6S24-1219P2L | * | TN6S24-1219P2B | 39,80 (1.566) | 40,50 (1.594) | 45,75 (1.800) |
| 24 | 00 | 48 (L) | 192991-0660 | TN6LS24-0048P2L | * | TN6LS24-0048P2B | 50,70 (2.000) | 40,50 (1.594) | 45,75 (1.800) |

Unsealed - Without Wire Seal and Securing Nut

| Shell Size | Contact Layout | | Single Piece Connector | | Bulk Packages (100 Connectors) | | A | ØB | ØC |
|------------|----------------|-----------------|------------------------|----------------|--------------------------------|----------------|---------------|------------------|---------------|
| | Power Contacts | Signal Contacts | Part Number | Nomenclature | Part Number | Nomenclature | | | |
| 16 | 02 | 13 | * | TN6U16-0213P2L | * | TN6U16-0213P2B | 34,70 (1.366) | 15/16 – 20 UNEF | 32,80 (1.291) |
| 24 | 04 | 20 | * | TN6U24-0420P2L | * | TN6U24-0420P2B | 35,70 (1.406) | 1-7/16 – 18 UNEF | 45,75 (1.800) |
| 24 | 04 | 28 | * | TN6U24-0428P2L | 192900-0692 | TN6U24-0428P2B | 35,70 (1.406) | 1-7/16 – 18 UNEF | 45,75 (1.800) |
| 24 | 12 | 19 | * | TN6U24-1219P2L | 192900-0691 | TN6U24-1219P2B | 35,70 (1.406) | 1-7/16 – 18 UNEF | 45,75 (1.800) |

* For details please consult the factory



Standard Receptacle for Socket Contacts
Flange Mounting

- For Wire Sealing Ranges, see page 34.
- 3,00 (.118) max with Panel Gasket.
- For Panel Gaskets, see page 47.



With Wire Seal and Securing Nut

| Shell Size | Contact Layout | | Single Piece Connector | | Bulk Packages (100 Connectors) | | A | B | C | ØD | ØE | F | G | ØH | ØJ | ØK |
|------------|----------------|-----------------|------------------------|-----------------|--------------------------------|-----------------|------------------|----------------|-----------------|------------------|------------------|------------------|------------------|----------------|------------------|------------------|
| | Power Contacts | Signal Contacts | Part Number | Nomenclature | Part Number | Nomenclature | | | | | | | | | | |
| 14 | 00 | 12 | 192900-0308 | TN0S14-0012S1L | 192900-0323 | TN0S14-0012S1B | 39,70 (1.563) | 3,50 (.137) | 11,40 (.448) | 22,20 (.874) | 24,30 (.956) | 28,60 (1.122) | 22,90 (.901) | 3,20 (.125) | 24,60 (.968) | 24,60 (.968) |
| 16 | 00 | 19 | 192900-0039 | TN0S16-0019S1L | 192900-0029 | TN0S16-0019S1B | 39,80 (1.566) | 2,30 (.090) | 11,40 (.448) | 25,40 (1.000) | 27,00 (1.063) | 31,00 (1.220) | 24,50 (.964) | 3,20 (.125) | 28,10 (1.106) | 28,10 (1.106) |
| 16 | 02 | 13 | 192900-0509 | TN0S16-0213S1L | 192900-0512 | TN0S16-0213S1B | 39,80 (1.566) | 2,30 (.090) | 11,40 (.448) | 25,40 (1.000) | 27,00 (1.063) | 31,00 (1.220) | 24,50 (.964) | 3,20 (.125) | 28,10 (1.106) | 28,10 (1.106) |
| 24 | 00 | 48 | 192900-0475 | TN0S24-0048S1L | 192900-0478 | TN0S24-0048S1B | 41,80 (1.645) | 3,50 (.137) | 15,40 (.606) | 38,10 (1.500) | 40,10 (1.578) | 50,80 (2.000) | 39,70 (1.563) | 4,20 (.165) | 41,00 (1.614) | 41,00 (1.614) |
| 24 | 04 | 20 | 192900-0030 | TN0S24-0420S1L | 192990-9420 | TN0S24-0420S1B | 41,80 (1.645) | 3,50 (.137) | 15,40 (.606) | 38,10 (1.500) | 40,10 (1.578) | 50,80 (2.000) | 39,70 (1.563) | 4,20 (.165) | 41,00 (1.614) | 41,00 (1.614) |
| 24 | 04 | 28 | 192900-0033 | TN0S24-0428S1L | 192900-0024 | TN0S24-0428S1B | 41,80 (1.645) | 3,50 (.137) | 15,40 (.606) | 38,10 (1.500) | 40,10 (1.578) | 50,80 (2.000) | 39,70 (1.563) | 4,20 (.165) | 41,00 (1.614) | 41,00 (1.614) |
| 24 | 12 | 19 | 192900-0036 | TN0S24-1219S1L | 192990-9390 | TN0S24-1219S1B | 41,80 (1.645) | 3,50 (.137) | 15,40 (.606) | 38,10 (1.500) | 40,10 (1.578) | 50,80 (2.000) | 39,70 (1.563) | 4,20 (.165) | 41,00 (1.614) | 41,00 (1.614) |
| 24 | 00 | 48 (L) | 192991-0640 | TN0LS24-0048S1L | * | TN0LS24-0048S1B | 52,70 (2.075) | 3,50 (.137) | 15,40 (.606) | 38,10 (1.500) | 40,10 (1.578) | 50,80 (2.000) | 39,70 (1.563) | 4,20 (.165) | 41,00 (1.614) | 41,00 (1.614) |

Without Securing Nut

| Shell Size | Contact Layout | | Single Piece Connector | | Bulk Packages (100 Connectors) | | A | B | C | ØD | ØE | F | G | ØH | ØJ | ØK |
|------------|----------------|-----------------|------------------------|----------------|--------------------------------|----------------|---|----------------|-----------------|------------------|------------------|------------------|------------------|----------------|------------------|------------------|
| | Power Contacts | Signal Contacts | Part Number | Nomenclature | Part Number | Nomenclature | | | | | | | | | | |
| 14 | 00 | 12 | * | TN0G14-0012S1L | 192900-0324 | TN0G14-0012S1B | - | 2,30 (.090) | 11,40 (.448) | 22,20 (.874) | 13/16 – 20 UNEF | 28,60 (1.122) | 22,90 (.901) | 3,20 (.125) | 24,60 (.968) | 24,60 (.968) |
| 16 | 00 | 19 | * | TN0G16-0019S1L | 192900-0105 | TN0G16-0019S1B | - | 2,30 (.090) | 11,40 (.448) | 25,40 (1.000) | 15/16 – 20 UNEF | 31,00 (1.220) | 24,50 (.964) | 3,20 (.125) | 28,10 (1.106) | 28,10 (1.106) |
| 24 | 00 | 48 | 192900-0479 | TN0G24-0048S1L | * | TN0G24-0048S1B | - | 3,50 (.137) | 15,40 (.606) | 38,18 (1.500) | 1-7/16 – 18 UNEF | 50,80 (2.000) | 39,70 (1.563) | 4,20 (.165) | 41,00 (1.614) | 41,00 (1.614) |
| 24 | 04 | 20 | * | TN0G24-0420S1L | 192900-0096 | TN0G24-0420S1B | - | 3,50 (.137) | 15,40 (.606) | 38,18 (1.500) | 1-7/16 – 18 UNEF | 50,80 (2.000) | 39,70 (1.563) | 4,20 (.165) | 41,00 (1.614) | 41,00 (1.614) |
| 24 | 04 | 28 | * | TN0G24-0428S1L | 192900-0099 | TN0G24-0428S1B | - | 3,50 (.137) | 15,40 (.606) | 38,18 (1.500) | 1-7/16 – 18 UNEF | 50,80 (2.000) | 39,70 (1.563) | 4,20 (.165) | 41,00 (1.614) | 41,00 (1.614) |
| 24 | 12 | 19 | * | TN0G24-1219S1L | 192900-0102 | TN0G24-1219S1B | - | 3,50 (.137) | 15,40 (.606) | 38,18 (1.500) | 1-7/16 – 18 UNEF | 50,80 (2.000) | 39,70 (1.563) | 4,20 (.165) | 41,00 (1.614) | 41,00 (1.614) |

* For details please consult the factory

Dimensions shown in mm (inch)
Specifications and dimensions subject to change

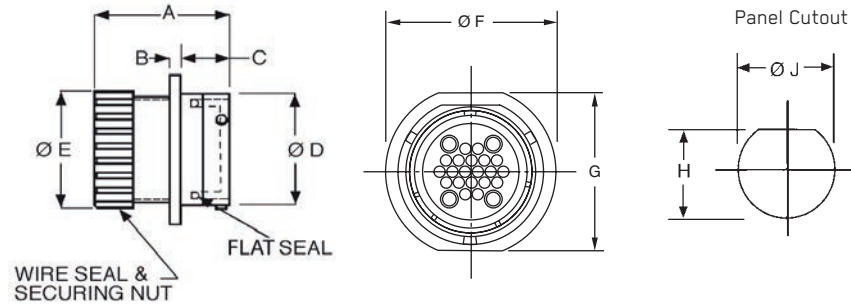

Standard Receptacle for Socket Contacts
Jam Nut Mounting

With Wire Seal and Securing Nut

- Bulk packages are not supplied with Jam Nuts, to order Jam Nuts, see page 46.
- For Wire Sealing Ranges, see page 34.
- Panel thickness 4,00 (.157) max.
- 3,00 (.118) max with Panel gasket.
- For Panel Gaskets, see page 47.

| Shell Size | Contact Layout | | Single Piece Connector | | Bulk Packages (100 Connectors) | | A | B | C | ØD | ØE | ØF | G | H | ØJ |
|------------|----------------|--------|------------------------|-----------------|--------------------------------|-------------------|------------------|----------------|-----------------|------------------|------------------|------------------|------------------|------------------|------------------|
| | Power | Signal | Part Number | Nomenclature | Part Number | Nomenclature | | | | | | | | | |
| 14 | 00 | 12 | 192900-0313 | TN7S14-0012S1L | 192900-0328 | TN7S14-0012S1B01 | 39,70 (1.563) | 3,50 (.137) | 22,10 (.870) | 22,20 (.874) | 24,30 (.956) | 35,80 (1.409) | 32,20 (1.267) | 25,10 (.988) | 27,30 (1.075) |
| 16 | 00 | 19 | 192900-0490 | TN7S16-0019S1L | 192900-0493 | TN7S16-0019S1B01 | 39,80 (1.566) | 2,30 (.090) | 23,00 (.905) | 25,40 (1.000) | 27,00 (1.063) | 39,80 (1.566) | 38,40 (1.511) | 28,00 (1.102) | 30,50 (1.200) |
| 16 | 02 | 13 | 192900-0508 | TN7S16-0213S1L | 192900-0511 | TN7S16-0213S1B01 | 39,80 (1.566) | 2,30 (.090) | 23,00 (.905) | 25,40 (1.000) | 27,00 (1.063) | 39,80 (1.566) | 38,40 (1.511) | 28,00 (1.102) | 30,50 (1.200) |
| 24 | 00 | 48 | 192900-0481 | TN7S24-0048S1L | 192900-0484 | TN7S24-0048S1B01 | 41,80 (1.645) | 3,50 (.137) | 23,40 (.921) | 38,10 (1.500) | 40,10 (1.578) | 51,00 (2.007) | 47,50 (1.870) | 41,50 (1.633) | 43,20 (1.700) |
| 24 | 04 | 20 | 192900-0032 | TN7S24-0420S1L | 192990-9460 | TN7S24-0420S1B01 | 41,80 (1.645) | 3,50 (.137) | 23,40 (.921) | 38,10 (1.500) | 40,10 (1.578) | 51,00 (2.007) | 47,50 (1.870) | 41,50 (1.633) | 43,20 (1.700) |
| 24 | 04 | 28 | 192900-0035 | TN7S24-0428S1L | 192900-0026 | TN7S24-0428S1B01 | 41,80 (1.645) | 3,50 (.137) | 23,40 (.921) | 38,10 (1.500) | 40,10 (1.578) | 51,00 (2.007) | 47,50 (1.870) | 41,50 (1.633) | 43,20 (1.700) |
| 24 | 12 | 19 | 192900-0038 | TN7S24-1219S1L | 192900-0028 | TN7S24-1219S1B01 | 41,80 (1.645) | 3,50 (.137) | 23,40 (.921) | 38,10 (1.500) | 40,10 (1.578) | 51,00 (2.007) | 47,50 (1.870) | 41,50 (1.633) | 43,20 (1.700) |
| 24 | 00 | 48 (L) | 192991-0644 | TN7LS24-0048S1L | * | TN7LS24-0048S1B01 | 52,70 (2.075) | 3,50 (.137) | 23,40 (.921) | 38,10 (1.500) | 40,10 (1.578) | 51,00 (2.007) | 47,50 (1.870) | 41,50 (1.633) | 43,20 (1.700) |

Without Securing Nut

| Shell Size | Contact Layout | | Single Piece Connector | | Bulk Packages (100 Connectors) | | A | B | C | ØD | ØE | ØF | G | H | ØJ |
|------------|----------------|--------|------------------------|----------------|--------------------------------|------------------|---|----------------|-----------------|------------------|-----------------------------|------------------|------------------|------------------|------------------|
| | Power | Signal | Part Number | Nomenclature | Part Number | Nomenclature | | | | | | | | | |
| 14 | 00 | 12 | * | TN7G14-0012S1L | 192900-0329 | TN7G14-0012S1B01 | - | 2,30 (.090) | 22,10 (.870) | 22,20 (.874) | 13/16 – 20 UNEF (1.409) | 35,80 (1.267) | 32,20 (.988) | 25,10 (1.075) | 27,30 (1.075) |
| 16 | 00 | 19 | * | TN7G16-0019S1L | * | TN7G16-0019S1B01 | - | 2,30 (.090) | 23,00 (.905) | 25,40 (1.000) | 15/16 – 20 UNEF (1.566) | 39,80 (1.511) | 38,40 (1.102) | 28,00 (1.200) | 30,50 (1.200) |
| 24 | 00 | 48 | * | TN7G24-0048S1L | * | TN7G24-0048S1B01 | - | 3,50 (.137) | 23,40 (.921) | 38,10 (1.500) | 1-7/16 – 18 UNEF (2.007) | 51,00 (1.870) | 47,50 (1.633) | 41,50 (1.700) | 43,20 (1.700) |
| 24 | 04 | 20 | * | TN7G24-0420S1L | 192900-0098 | TN7G24-0420S1B01 | - | 3,50 (.137) | 23,40 (.921) | 38,10 (1.500) | 1-7/16 – 18 UNEF (2.007) | 51,00 (1.870) | 47,50 (1.633) | 41,50 (1.700) | 43,20 (1.700) |
| 24 | 04 | 28 | * | TN7G24-0428S1L | 192900-0101 | TN7G24-0428S1B01 | - | 3,50 (.137) | 23,40 (.921) | 38,10 (1.500) | 1-7/16 – 18 UNEF (2.007) | 51,00 (1.870) | 47,50 (1.633) | 41,50 (1.700) | 43,20 (1.700) |
| 24 | 12 | 19 | * | TN7G24-1219S1L | 192900-0104 | TN7G24-1219S1B01 | - | 3,50 (.137) | 23,40 (.921) | 38,10 (1.500) | 1-7/16 – 18 UNEF (2.007) | 51,00 (1.870) | 47,50 (1.633) | 41,50 (1.700) | 43,20 (1.700) |

Unsealed - Without Wire Seal and Securing Nut

| Shell Size | Contact Layout | | Single Piece Connector | | Bulk Packages (100 Connectors) | | A | B | C | ØD | ØE | ØF | G | H | ØJ |
|------------|----------------|--------|------------------------|----------------|--------------------------------|------------------|---------------|------------|-------------|--------------|------------------|--------------|--------------|--------------|--------------|
| | Power | Signal | Part Number | Nomenclature | Part Number | Nomenclature | | | | | | | | | |
| 16 | 02 | 13 | * | TN7U16-0213S1L | * | TN7U16-0213S1B01 | 35,60 (1.402) | 2,30(.090) | 23,00(.905) | 25,40(1.000) | 15/16 – 20 UNEF | 39,80(1.566) | 38,40(1.511) | 28,00(1.102) | 30,50(1.200) |
| 24 | 04 | 20 | * | TN7U24-0420S1L | * | TN7U24-0420S1B01 | 37,65 (1.482) | 3,50(.137) | 23,40(.921) | 38,10(1.500) | 1-7/16 – 18 UNEF | 51,00(2.007) | 47,50(1.870) | 41,50(1.633) | 43,20(1.700) |
| 24 | 04 | 28 | * | TN7U24-0428S1L | * | TN7U24-0428S1B01 | 37,65 (1.482) | 3,50(.137) | 23,40(.921) | 38,10(1.500) | 1-7/16 – 18 UNEF | 51,00(2.007) | 47,50(1.870) | 41,50(1.633) | 43,20(1.700) |
| 24 | 12 | 19 | * | TN7U24-1219S1L | * | TN7U24-1219S1B01 | 37,65 (1.482) | 3,50(.137) | 23,40(.921) | 38,10(1.500) | 1-7/16 – 18 UNEF | 51,00(2.007) | 47,50(1.870) | 41,50(1.633) | 43,20(1.700) |

* For details please consult the factory



Dimensions shown in mm (inch)
Specifications and dimensions subject to change



Reversed Plugs
for Socket Contacts
Metal Locking Ring

- For Wire Sealing Ranges, see page 34.
- Accepts socket contacts, see page 60.
- Water sealed to IP67.



With Wire Seal and Securing Nut

| Shell Size | Contact Layout | | Single Piece Connector | | Bulk Packages (100 Connectors) | | A | ØB | ØC | D |
|------------|----------------|-----------------|------------------------|-----------------|--------------------------------|-----------------|---------------|---------------|---------------|--------------------------|
| | Power Contacts | Signal Contacts | Part Number | Nomenclature | Part Number | Nomenclature | | | | |
| 14 | 00 | 12 | 192900-0236 | TN6S14-0012S1L | 192900-0241 | TN6S14-0012S1B | 31,60 (1.244) | 24,30 (.957) | 28,00 (1.102) | 19,10 ±0,20 (.751 ±.007) |
| 16 | 00 | 19 | 192900-0057 | TN6S16-0019S1L | 192990-9970 | TN6S16-0019S1B | 31,70 (1.248) | 27,00 (1.063) | 30,20 (1.189) | 19,10 ±0,20 (.751 ±.007) |
| 16 | 02 | 13 | 192900-0581 | TN6S16-0213S1L | * | TN6S16-0213S1B | 31,70 (1.248) | 27,00 (1.063) | 30,20 (1.189) | 19,10 ±0,20 (.751 ±.007) |
| 24 | 00 | 48 | 192900-0425 | TN6S24-0048S1L | 192900-0428 | TN6S24-0048S1B | 32,40 (1.275) | 40,50 (1.594) | 44,00 (1.732) | 14,72 ±0,15 (.580 ±.006) |
| 24 | 04 | 20 | 192900-0054 | TN6S24-0420S1L | 192990-9450 | TN6S24-0420S1B | 32,40 (1.275) | 40,50 (1.594) | 44,00 (1.732) | 14,72 ±0,15 (.580 ±.006) |
| 24 | 04 | 28 | 192900-0055 | TN6S24-0428S1L | 192900-0053 | TN6S24-0428S1B | 32,40 (1.275) | 40,50 (1.594) | 44,00 (1.732) | 14,72 ±0,15 (.580 ±.006) |
| 24 | 12 | 19 | 192900-0056 | TN6S24-1219S1L | 192990-9240 | TN6S24-1219S1B | 32,40 (1.275) | 40,50 (1.594) | 44,00 (1.732) | 14,72 ±0,15 (.580 ±.006) |
| 24 | 00 | 48 (L) | 192991-0648 | TN6LS24-0048S1L | * | TN6LS24-0048S1B | 43,00 (1.693) | 40,50 (1.594) | 44,00 (1.732) | 14,72 ±0,15 (.580 ±.006) |

Without Securing Nut

| Shell Size | Contact Layout | | Single Piece Connector | | Bulk Packages (100 Connectors) | | A | ØB | ØC | D |
|------------|----------------|-----------------|------------------------|----------------|--------------------------------|----------------|---|----------------|---------------|--------------------------|
| | Power Contacts | Signal Contacts | Part Number | Nomenclature | Part Number | Nomenclature | | | | |
| 14 | 00 | 12 | * | TN6G14-0012S1L | 192900-0242 | TN6G14-0012S1B | - | 13/16-20 UNEF | 28,00 (1.102) | 19,10 ±0,20 (.751 ±.007) |
| 16 | 00 | 19 | * | TN6G16-0019S1L | 192900-0109 | TN6G16-0019S1B | - | 15/16-20 UNEF | 30,20 (1.189) | 19,10 ±0,20 (.751 ±.007) |
| 24 | 00 | 48 | * | TN6G24-0048S1L | 192900-0429 | TN6G24-0048S1B | - | 1-7/16-18 UNEF | 44,00 (1.732) | 14,72 ±0,15 (.580 ±.006) |
| 24 | 04 | 20 | * | TN6G24-0420S1L | 192900-0106 | TN6G24-0420S1B | - | 1-7/16-18 UNEF | 44,00 (1.732) | 14,72 ±0,15 (.580 ±.006) |
| 24 | 04 | 28 | * | TN6G24-0428S1L | 192900-0107 | TN6G24-0428S1B | - | 1-7/16-18 UNEF | 44,00 (1.732) | 14,72 ±0,15 (.580 ±.006) |
| 24 | 12 | 19 | * | TN6G24-1219S1L | 192900-0108 | TN6G24-1219S1B | - | 1-7/16-18 UNEF | 44,00 (1.732) | 14,72 ±0,15 (.580 ±.006) |

Unsealed - Without Wire Seal and Securing Nut

| Shell Size | Contact Layout | | Single Piece Connector | | Bulk Packages (100 Connectors) | | A | ØB | ØC | D |
|------------|----------------|-----------------|------------------------|----------------|--------------------------------|----------------|---------------|----------------|---------------|--------------------------|
| | Power Contacts | Signal Contacts | Part Number | Nomenclature | Part Number | Nomenclature | | | | |
| 16 | 02 | 13 | * | TN6U16-0213S1L | * | TN6U16-0213S1B | 27,55 (1.085) | 15/16-20 UNEF | 30,20 (1.189) | 19,10 ±0,20 (.751 ±.007) |
| 24 | 04 | 20 | * | TN6U24-0420S1L | * | TN6U24-0420S1B | 28,10 (1.106) | 1-7/16-18 UNEF | 44,00 (1.732) | 14,72 ±0,15 (.580 ±.006) |
| 24 | 04 | 28 | * | TN6U24-0428S1L | * | TN6U24-0428S1B | 28,10 (1.106) | 1-7/16-18 UNEF | 44,00 (1.732) | 14,72 ±0,15 (.580 ±.006) |
| 24 | 12 | 19 | * | TN6U24-1219S1L | * | TN6U24-1219S1B | 28,10 (1.106) | 1-7/16-18 UNEF | 44,00 (1.732) | 14,72 ±0,15 (.580 ±.006) |

* For details please consult the factory

Dimensions shown in mm (inch)
Specifications and dimensions subject to change



Reverse plugs
for Socket Contacts
Plastic Locking Ring



- For Wire Sealing Ranges, see page 34.
- Accepts socket contacts, see page 60.
- Water sealed to IP67.

With Wire Seal and Securing Nut

| Shell Size | Contact Layout | | Single Piece Connector | | Bulk Packages (100 Connectors) | | A | ØB | ØC |
|------------|----------------|-----------------|------------------------|-----------------|--------------------------------|-----------------|---------------|---------------|---------------|
| | Power Contacts | Signal Contacts | Part Number | Nomenclature | Part Number | Nomenclature | | | |
| 16 | 00 | 19 | 192900-0558 | TN6S16-0019S2L | 192900-0560 | TN6S16-0019S2B | 31,70 (1.248) | 27,00 (1.063) | 32,80 (1.291) |
| 16 | 02 | 13 | 192900-0562 | TN6S16-0213S2L | 192900-0564 | TN6S16-0213S2B | 31,70 (1.248) | 27,00 (1.063) | 32,80 (1.291) |
| 24 | 00 | 48 | 192900-0542 | TN6S24-0048S2L | 192900-0548 | TN6S24-0048S2B | 32,40 (1.275) | 40,50 (1.594) | 44,00 (1.732) |
| 24 | 04 | 20 | 192900-0540 | TN6S24-0420S2L | * | TN6S24-0420S2B | 32,40 (1.275) | 40,50 (1.594) | 44,00 (1.732) |
| 24 | 04 | 28 | 192900-0550 | TN6S24-0428S2L | 192900-0552 | TN6S24-0428S2B | 32,40 (1.275) | 40,50 (1.594) | 44,00 (1.732) |
| 24 | 12 | 19 | 192900-0541 | TN6S24-1219S2L | 192900-0547 | TN6S24-1219S2B | 32,40 (1.275) | 40,50 (1.594) | 44,00 (1.732) |
| 24 | 00 | 48 (L) | 192991-0664 | TN6LS24-0048S2L | * | TN6LS24-0048S2B | 43,00 (1.693) | 40,50 (1.594) | 44,00 (1.732) |

Unsealed - Without Wire Seal and Securing Nut

| Shell Size | Contact Layout | | Single Piece Connector | | Bulk Packages (100 Connectors) | | A | ØB | ØC |
|------------|----------------|-----------------|------------------------|----------------|--------------------------------|----------------|---------------|------------------|---------------|
| | Power Contacts | Signal Contacts | Part Number | Nomenclature | Part Number | Nomenclature | | | |
| 16 | 02 | 13 | * | TN6U16-0213S2L | * | TN6U16-0213S2B | 27,55 (1.085) | 15/16 – 20 UNEF | 32,80 (1.291) |
| 24 | 04 | 20 | * | TN6U24-0420S2L | * | TN6U24-0420S2B | 28,10 (1.106) | 1-7/16 – 18 UNEF | 44,00 (1.732) |
| 24 | 04 | 28 | * | TN6U24-0428S2L | * | TN6U24-0428S2B | 28,10 (1.106) | 1-7/16 – 18 UNEF | 44,00 (1.732) |
| 24 | 12 | 19 | * | TN6U24-1219S2L | * | TN6U24-1219S2B | 28,10 (1.106) | 1-7/16 – 18 UNEF | 44,00 (1.732) |

* For details please consult the factory





Reversed Receptacle for Pin Contacts
Flange Mounting

- For Wire Sealing Ranges, see page 34.
- 3,00 (.118) max with Panel Gasket. For Panel Gaskets, see page 47.



ØJ = Flange in Front of Panel
ØK = Flange at Rear of Panel

With Wire Seal and Securing Nut

| Shell Size | Contact Layout | | Single Piece Connector | | Bulk Packages (100 Connectors) | | A | B | C | ØD | ØE | F | G | ØH | ØJ | ØK |
|------------|----------------|-----------------|------------------------|-----------------|--------------------------------|-----------------|------------------|----------------|-----------------|------------------|------------------|------------------|------------------|----------------|------------------|------------------|
| | Power Contacts | Signal Contacts | Part Number | Nomenclature | Part Number | Nomenclature | | | | | | | | | | |
| 14 | 00 | 12 | 192900-0256 | TN0S14-0012P1L | 192900-0261 | TN0S14-0012P1B | 39,70 (1.563) | 2,30 (.090) | 11,40 (.448) | 22,20 (.874) | 24,30 (.956) | 28,60 (1.122) | 22,90 (.901) | 3,20 (.125) | 24,60 (.968) | 24,60 (.968) |
| 16 | 00 | 19 | 192900-0078 | TN0S16-0019P1L | 192990-9980 | TN0S16-0019P1B | 39,80 (1.566) | 2,30 (.090) | 11,40 (.448) | 25,40 (1.000) | 27,00 (1.063) | 31,00 (1.220) | 24,50 (.964) | 3,20 (.125) | 28,10 (1.106) | 28,10 (1.106) |
| 16 | 02 | 13 | 192900-0582 | TN0S16-0213P1L | * | TN0S16-0213P1B | 39,80 (1.566) | 2,30 (.090) | 11,40 (.448) | 25,40 (1.000) | 27,00 (1.063) | 31,00 (1.220) | 24,50 (.964) | 3,20 (.125) | 28,10 (1.106) | 28,10 (1.106) |
| 24 | 00 | 48 | 192900-0431 | TN0S24-0048P1L | 192900-0434 | TN0S24-0048P1B | 41,80 (1.645) | 3,50 (.137) | 15,40 (.606) | 38,10 (1.500) | 40,10 (1.578) | 50,80 (2.000) | 39,70 (1.563) | 4,20 (.165) | 41,00 (1.614) | 41,00 (1.614) |
| 24 | 04 | 20 | 192900-0069 | TN0S24-0420P1L | 192990-9440 | TN0S24-0420P1B | 41,80 (1.645) | 3,50 (.137) | 15,40 (.606) | 38,10 (1.500) | 40,10 (1.578) | 50,80 (2.000) | 39,70 (1.563) | 4,20 (.165) | 41,00 (1.614) | 41,00 (1.614) |
| 24 | 04 | 28 | 192900-0072 | TN0S24-0428P1L | 192900-0064 | TN0S24-0428P1B | 41,80 (1.645) | 3,50 (.137) | 15,40 (.606) | 38,10 (1.500) | 40,10 (1.578) | 50,80 (2.000) | 39,70 (1.563) | 4,20 (.165) | 41,00 (1.614) | 41,00 (1.614) |
| 24 | 12 | 19 | 192900-0075 | TN0S24-1219P1L | 192990-9250 | TN0S24-1219P1B | 41,80 (1.645) | 3,50 (.137) | 15,40 (.606) | 38,10 (1.500) | 40,10 (1.578) | 50,80 (2.000) | 39,70 (1.563) | 4,20 (.165) | 41,00 (1.614) | 41,00 (1.614) |
| 24 | 00 | 48 (L) | 192991-0652 | TN0LS24-0048P1L | * | TN0LS24-0048P1B | 52,70 (2.075) | 3,50 (.137) | 15,40 (.606) | 38,10 (1.500) | 40,10 (1.578) | 50,80 (2.000) | 39,70 (1.563) | 4,20 (.165) | 41,00 (1.614) | 41,00 (1.614) |

Without Securing Nut

| Shell Size | Contact Layout | | Single Piece Connector | | Bulk Packages (100 Connectors) | | A | B | C | ØD | ØE | F | G | ØH | ØJ | ØK |
|------------|----------------|-----------------|------------------------|----------------|--------------------------------|----------------|---|----------------|-----------------|------------------|------------------|------------------|------------------|----------------|------------------|------------------|
| | Power Contacts | Signal Contacts | Part Number | Nomenclature | Part Number | Nomenclature | | | | | | | | | | |
| 14 | 00 | 12 | * | TN0G14-0012P1L | 192900-0262 | TN0G14-0012P1B | - | 2,30 (.090) | 11,40 (.448) | 22,20 (.874) | 15/16 – 20 UNEF | 28,60 (1.122) | 22,90 (.901) | 3,20 (.125) | 24,60 (.968) | 24,60 (.968) |
| 16 | 00 | 19 | * | TN0G16-0019P1L | 192900-0119 | TN0G16-0019P1B | - | 2,30 (.090) | 11,40 (.448) | 25,40 (1.000) | 15/16 – 20 UNEF | 31,00 (1.220) | 24,50 (.964) | 3,20 (.125) | 28,10 (1.106) | 28,10 (1.106) |
| 24 | 00 | 48 | * | TN0G24-0048P1L | 192900-0435 | TN0G24-0048P1B | - | 3,50 (.137) | 15,40 (.606) | 38,10 (1.500) | 1-7/16 – 18 UNEF | 50,80 (2.000) | 39,70 (1.563) | 4,20 (.165) | 41,00 (1.614) | 41,00 (1.614) |
| 24 | 04 | 20 | * | TN0G24-0420P1L | 192900-0110 | TN0G24-0420P1B | - | 3,50 (.137) | 15,40 (.606) | 38,10 (1.500) | 1-7/16 – 18 UNEF | 50,80 (2.000) | 39,70 (1.563) | 4,20 (.165) | 41,00 (1.614) | 41,00 (1.614) |
| 24 | 04 | 28 | * | TN0G24-0428P1L | 192900-0113 | TN0G24-0428P1B | - | 3,50 (.137) | 15,40 (.606) | 38,10 (1.500) | 1-7/16 – 18 UNEF | 50,80 (2.000) | 39,70 (1.563) | 4,20 (.165) | 41,00 (1.614) | 41,00 (1.614) |
| 24 | 12 | 19 | * | TN0G24-1219P1L | 192900-0116 | TN0G24-1219P1B | - | 3,50 (.137) | 15,40 (.606) | 38,10 (1.500) | 1-7/16 – 18 UNEF | 50,80 (2.000) | 39,70 (1.563) | 4,20 (.165) | 41,00 (1.614) | 41,00 (1.614) |

* For details please consult the factory

Dimensions shown in mm (inch)
Specifications and dimensions subject to change



Reversed Receptacle for Pin Contacts
Jam Nut Mounting

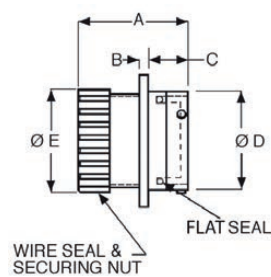

• For Wire Sealing Ranges, see page 34.

- Panel thickness 4,00 (.157) max
- 3,00 (.118) max with Panel gasket.
- For Panel Gaskets, see page 47.
- Bulk packages are not supplied with Jam Nuts. To order Jam Nuts see page 47.

With Wire Seal and Securing Nut

| Shell Size | Contact Layout | | Single Piece Connector | | Bulk Packages (100 Connectors) | | A | B | C | ØD | ØE | ØF | G | H | ØJ |
|------------|----------------|--------|------------------------|-----------------|--------------------------------|-------------------|------------------|----------------|-----------------|------------------|------------------|------------------|------------------|------------------|------------------|
| | Power | Signal | Part Number | Nomenclature | Part Number | Nomenclature | | | | | | | | | |
| 14 | 00 | 12 | 192900-0266 | TN7S14-0012P1L | 192900-0271 | TN7S14-0012P1B01 | 39,70 (1.563) | 3,50 (.137) | 22,10 (.870) | 22,20 (.874) | 24,30 (.956) | 35,80 (1.409) | 32,20 (1.267) | 25,10 (.988) | 27,30 (1.075) |
| 16 | 00 | 19 | 192900-0353 | TN7S16-0019P1L | 192900-0395 | TN7S16-0019P1B01 | 39,80 (1.566) | 2,30 (.090) | 23,00 (.905) | 25,40 (1.000) | 27,00 (1.063) | 39,80 (1.566) | 38,40 (1.511) | 28,00 (1.102) | 30,50 (1.200) |
| 16 | 02 | 13 | 192900-0583 | TN7S16-0213P1L | 192900-0586 | TN7S16-0213P1B01 | 39,80 (1.566) | 2,30 (.090) | 23,00 (.905) | 25,40 (1.000) | 27,00 (1.063) | 39,80 (1.566) | 38,40 (1.511) | 28,00 (1.102) | 30,50 (1.200) |
| 24 | 00 | 48 | 192900-0437 | TN7S24-0048P1L | 192900-0440 | TN7S24-0048P1B01 | 41,80 (1.645) | 3,50 (.137) | 23,40 (.921) | 38,10 (1.500) | 40,10 (1.578) | 51,00 (2.007) | 47,50 (1.870) | 41,50 (1.633) | 43,20 (1.700) |
| 24 | 04 | 20 | 192900-0071 | TN7S24-0420P1L | 192990-9470 | TN7S24-0420P1B01 | 41,80 (1.645) | 3,50 (.137) | 23,40 (.921) | 38,10 (1.500) | 40,10 (1.578) | 51,00 (2.007) | 47,50 (1.870) | 41,50 (1.633) | 43,20 (1.700) |
| 24 | 04 | 28 | 192900-0074 | TN7S24-0428P1L | 192900-0066 | TN7S24-0428P1B01 | 41,80 (1.645) | 3,50 (.137) | 23,40 (.921) | 38,10 (1.500) | 40,10 (1.578) | 51,00 (2.007) | 47,50 (1.870) | 41,50 (1.633) | 43,20 (1.700) |
| 24 | 12 | 19 | 192900-0077 | TN7S24-1219P1L | 192900-0068 | TN7S24-1219P1B01 | 41,80 (1.645) | 3,50 (.137) | 23,40 (.921) | 38,10 (1.500) | 40,10 (1.578) | 51,00 (2.007) | 47,50 (1.870) | 41,50 (1.633) | 43,20 (1.700) |
| 24 | 00 | 48 (L) | 192991-0656 | TN7LS24-0048P1L | * | TN7LS24-0048P1B01 | 52,70 (2.075) | 3,50 (.137) | 23,40 (.921) | 38,10 (1.500) | 40,10 (1.578) | 51,00 (2.007) | 47,50 (1.870) | 41,50 (1.633) | 43,20 (1.700) |

Without Securing Nut

| Shell Size | Contact Layout | | Single Piece Connector | | Bulk Packages (100 Connectors) | | A | B | C | ØD | ØE | ØF | G | H | ØJ |
|------------|----------------|--------|------------------------|----------------------------|--------------------------------|------------------|---|----------------|-----------------|------------------|------------------|------------------|------------------|------------------|------------------|
| | Power | Signal | Part Number | Nomenclature | Part Number | Nomenclature | | | | | | | | | |
| 14 | 00 | 12 | * | TN7G14-0012P1L | 192900-0370 | TN7G14-0012P1B01 | - | 2,30 (.090) | 22,10 (.870) | 22,20 (.874) | 15/16 – 20 UNEF | 35,80 (1.409) | 32,20 (1.267) | 25,10 (.988) | 27,30 (1.075) |
| 16 | 00 | 19 | * | TN7G16-0019P1L | 192900-0396 | TN7G16-0019P1B01 | - | 2,30 (.090) | 23,00 (.905) | 25,40 (1.000) | 15/16 – 20 UNEF | 39,80 (1.566) | 38,40 (1.511) | 28,00 (1.102) | 30,50 (1.200) |
| 24 | 00 | 48 | | 192900-0438 TN7G24-0048P1L | 192900-0441 | TN7G24-0048P1B01 | - | 3,50 (.137) | 23,40 (.921) | 38,10 (1.500) | 1-7/16 – 18 UNEF | 51,00 (2.007) | 47,50 (1.870) | 41,50 (1.633) | 43,20 (1.700) |
| 24 | 04 | 20 | * | TN7G24-0420P1L | 192900-0112 | TN7G24-0420P1B01 | - | 3,50 (.137) | 23,40 (.921) | 38,10 (1.500) | 1-7/16 – 18 UNEF | 51,00 (2.007) | 47,50 (1.870) | 41,50 (1.633) | 43,20 (1.700) |
| 24 | 04 | 28 | * | TN7G24-0428P1L | 192900-0115 | TN7G24-0428P1B01 | - | 3,50 (.137) | 23,40 (.921) | 38,10 (1.500) | 1-7/16 – 18 UNEF | 51,00 (2.007) | 47,50 (1.870) | 41,50 (1.633) | 43,20 (1.700) |
| 24 | 12 | 19 | * | TN7G24-1219P1L | 192900-0118 | TN7G24-1219P1B01 | - | 3,50 (.137) | 23,40 (.921) | 38,10 (1.500) | 1-7/16 – 18 UNEF | 51,00 (2.007) | 47,50 (1.870) | 41,50 (1.633) | 43,20 (1.700) |

Unsealed- Without Wire Seal and Securing Nut

| Shell Size | Contact Layout | | Single Piece Connector | | Bulk Packages (100 Connectors) | | A | B | C | ØD | ØE | ØF | G | H | ØJ |
|------------|----------------|--------|------------------------|----------------|--------------------------------|------------------|------------------|----------------|-----------------|------------------|------------------|------------------|------------------|------------------|------------------|
| | Power | Signal | Part Number | Nomenclature | Part Number | Nomenclature | | | | | | | | | |
| 16 | 02 | 13 | * | TN7U16-0213P1L | * | TN7U16-0213P1B01 | 35,60 (1.402) | 2,30 (.090) | 23,00 (.905) | 25,40 (1.000) | 15/16 – 20 UNEF | 39,80 (1.566) | 38,40 (1.511) | 28,00 (1.102) | 30,50 (1.200) |
| 24 | 04 | 20 | * | TN7U24-0420P1L | * | TN7U24-0420P1B01 | 37,65 (1.482) | 3,50 (.137) | 23,40 (.921) | 38,10 (1.500) | 1-7/16 – 18 UNEF | 51,00 (2.007) | 47,50 (1.870) | 41,50 (1.633) | 43,20 (1.700) |
| 24 | 04 | 28 | * | TN7U24-0428P1L | * | TN7U24-0428P1B01 | 37,65 (1.482) | 3,50 (.137) | 23,40 (.921) | 38,10 (1.500) | 1-7/16 – 18 UNEF | 51,00 (2.007) | 47,50 (1.870) | 41,50 (1.633) | 43,20 (1.700) |
| 24 | 12 | 19 | * | TN7U24-1219P1L | * | TN7U24-1219P1B01 | 37,65 (1.482) | 3,50 (.137) | 23,40 (.921) | 38,10 (1.500) | 1-7/16 – 18 UNEF | 51,00 (2.007) | 47,50 (1.870) | 41,50 (1.633) | 43,20 (1.700) |

* For details please consult the factory



Dimensions shown in mm (inch)
Specifications and dimensions subject to change

How to Order-Accessories

Typical Nomenclature:

TNA 24 CA01 - 20 L

Series

TNA = Trident Neptune Accessory

Shell Size

14
16
24
** Blanking Plug

Packaging

B = Bulk
L = Single Pack

Accessory Style, Type, and Size

| Accessory Style, Type, and Size | | |
|---------------------------------|-------|--|
| Conduit Adapter | | |
| CA | 01-xx | Type 1, xx=diameter of conduit* |
| CA | 02-xx | Type 2, xx=diameter of conduit* |
| CA | 03-xx | Type 3, xx=diameter of conduit* |
| Cable Clamp | | |
| CC | HC-00 | Sealed |
| CC | SR-00 | Unsealed |
| Panel Gasket | | |
| PG | 01-00 | Flange Type |
| PG | 03-00 | Jam Nut Type |
| Dust Cap | | |
| DC | P0-00 | Sealed Dust Cap, Plug |
| DC | R0-01 | Sealed Dust Cap, Receptacle (Top Hat)*** |
| Spare Jam Nut | | |
| JN | 00-00 | |
| Blanking Plug | | |
| BP | SG-00 | For Signal Holes |

*** Can be sealed up to IP 67

***Conduit Adapter Sizes**

| Shell Size | Type | Diameter (mm) |
|------------|------|---------------|
| 14 | 01 | 12 |
| 16 | 01 | 20 |
| 16 | 02 | 18 |
| 24 | 01 | 20 |
| 24 | 01 | 25 |
| 24 | 02 | 25 |
| 24 | 02 | 26 |
| 24 | 03 | 34 |

Dimensions shown in mm (inch)
Specifications and dimensions subject to change



Sealed Cable Clamps for Use With Neptune Circular Connectors

* For disassembly, add 9,00 (.354) for shell sizes 14 and 16 and add 10,60 (.417) for shell size 24.

- For use with jacketed cables.
- Provides Strain relief and wire protection.
- Provides sealing to IP67.
- For assembly instructions, see page 76.

| Shell Size | Part Number | Nomenclature | ØA max. | B | C max. | Wire Sealing Diameter | |
|------------|-------------|---------------|---------------|---------------|----------------|-----------------------|---------------|
| | | | | | | Minimum | Maximum |
| 14 | 192900-0496 | TNA14CCHC-00L | 14,60 (.574) | 22,80 (.897) | 85,50 (3.366) | 6,50 (.256) | 12,40 (.488) |
| 16 | 192900-0497 | TNA16CCHC-00L | 16,60 (.653) | 24,70 (.972) | 89,80 (3.535) | 6,50 (.256) | 12,40 (.488) |
| 24 | 192900-0498 | TNA24CCHC-00L | 29,60 (1.165) | 41,80 (1.645) | 128,50 (5.059) | 17,00 (.670) | 26,50 (1.040) |

* Assumes a uniformly cylindrical cable. Variations in the diameter could effect sealing.



* For disassembly, add 9,00 (.354) for shell sizes 14 and 16 and add 10,60 (.417) for shell size 24.

Unsealed Cable Clamps for Use With Neptune Circular Connectors

- Provides strain relief and wire protection.
- For use with discrete wires or jacketed cables.
- For assembly instructions, see page 76.

| Shell Size | Part Number | Nomenclature | ØA max. | B | ØC max. | ØD | E max. |
|------------|-------------|---------------|---------------|-------------|---------------|---------------|---------------|
| | | | | | | | E max. |
| 14 | 192900-0286 | TNA14CCSR-00L | 27,00 (1.063) | 6,40 (.251) | 13,80 (.543) | 27,00 (1.063) | 67,10 (2.641) |
| 16 | 192900-0343 | TNA16CCSR-00L | 30,10 (1.185) | 6,40 (.251) | 17,00 (.669) | 30,20 (1.189) | 67,10 (2.641) |
| 24 | 192900-0344 | TNA24CCSR-00L | 41,80 (1.645) | 8,20 (.322) | 28,00 (1.102) | 42,50 (1.673) | 90,80 (3.574) |



Conduit Adapters

Adapters facilitate the fitting of various accessories to the Neptune housings.



Figure 1

Type 1

- External threads for use with conduit.



Figure 1



Figure 2

Single Piece Pack

| Shell Size | Figure | Part Number | Nomenclature | A | ØB | ØC |
|------------|--------|-------------|---------------|---------------|---------------|---------------|
| 16 | 1 | 192900-0187 | TNA16CA01-20L | 28,60 (1.126) | 28,00 (1.102) | 21,50 (.846) |
| 24 | 2 | 192900-0184 | TNA24CA01-20L | 47,00 (1.850) | 44,00 (1.732) | 21,50 (.846) |
| 24 | 1 | 192900-0185 | TNA24CA01-25L | 32,00 (1.260) | 43,50 (1.713) | 28,50 (1.122) |



Type 2

- External grooves for heat shrink tubing or conduit "push-fit" onto the adapter.
- Standard type is recommended for sealed connections to the adapter.
- Drain hole type is recommended for non sealed connections. E.g. split conduit.

Figure 1



Standard Type

Figure 2

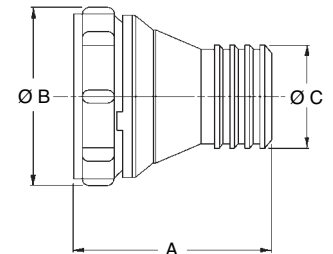

Drain Hole Type

Single Piece Pack

| Shell Size | Figure | Part Number | Nomenclature | A | ØB | ØC |
|------------|--------|-------------|---------------|---------------|---------------|--------------|
| 16 | 1 | 192991-0015 | TNA16CA02-18L | 37,80 (1.488) | 27,50 (1.082) | 17,40 (.685) |
| 24 | 1 | 192991-0013 | TNA24CA02-26L | 46,70 (1.839) | 41,50 (1.634) | 24,00 (.945) |
| 24 | 2 | 192900-0654 | TNA24CA02-25L | 46,70 (1.839) | 41,50 (1.634) | 24,00 (.945) |



Type 3

- For use with a 90° elbow.
- External threads for use with conduit.



Single Piece Pack

| Shell Size | Part Number | Nomenclature | A | ØB |
|------------|-------------|---------------|---------------|---------------|
| 24 | 192900-0226 | TNA24CA03-34L | 36,50 (1.437) | 34,70 (1.366) |

Dimensions shown in mm (inch)
Specifications and dimensions subject to change



Blanking Plugs for Signal Cavities

Blanking Plugs

- Blanking plugs are used to repair damaged seals. If the membrane seal is pierced in a position that is not normally used, then the blanking plug will restore the seal.

Note: Replacement membrane seals are also available. Contact ITT for details.



Pack of 100

| Part Number | Nomenclature |
|--------------------|----------------------|
| 192991-0018 | TNA**BPSG-00B |



Discriminating Pin Insertion



Discriminating (Keying) Pins

- Discriminating (keying) pins are used to prevent cross-mating of similar connectors. These pins are used in place of a pin contact. The corresponding socket cavity must be left open. If a socket contact is present, the discriminating pin will prevent mating.
- The discriminating pin is installed from the mating side of the connector.

Prevents Cross - Mating

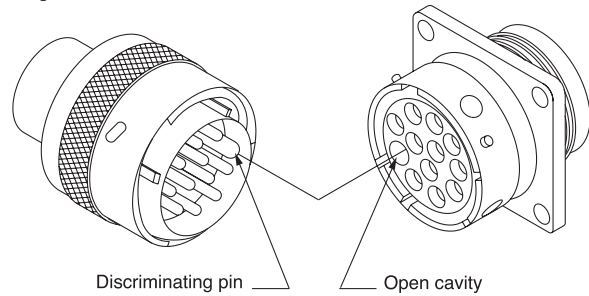

| Pin Type | Part Number (Pack of 25) |
|----------|-----------------------------|
| Signal | 192990-0000 |
| Power | 192900-0189 |



Spare Jam Nuts

- To order with Bulk packaged Jam Nut Receptacles.



| Shell | Pack of 100 | | | | |
|-------|-------------|---------------|---------------|---------------|-------------|
| Size | Part Number | Nomenclature | ØA max. | B Nom | C |
| 14 | 192900-0489 | TNA14JN00-00B | 36,00 (1.417) | 31,00 (1.220) | 6,00 (.236) |
| 16 | 192900-0488 | TNA16JN00-00B | 40,60 (1.598) | 35,00 (1.378) | 6,00 (.236) |
| 24 | 192900-0487 | TNA24JN00-00B | 56,00 (2.205) | 49,00 (1.929) | 7,00 (.275) |



Dimensions shown in mm (inch)
Specifications and dimensions subject to change



Plug Dust Cap

Receptacle Dust Cap

Sealed Plastic Dust Caps

Plastic Dust Caps are available for both plugs and receptacles. It is immaterial whether these are standard or reversed types, only the shell size matters in determining the correct item.



Plug Dust Cap

| Shell | Pack of 100 | | ØA | ØB | C |
|-------|-------------|---------------|---------------|---------------|--------------|
| Size | Part Number | Nomenclature | | | |
| 14 | 192991-0673 | TNA14DCP0-00B | 22,17 (.873) | 28,40 (1.118) | 15,00 (.591) |
| 16 | 192900-0388 | TNA16DCP0-00B | 25,40 (1.000) | 31,70 (1.248) | 14,30 (.562) |
| 24 | 192900-0392 | TNA24DCP0-00B | 38,10 (1.500) | 44,40 (1.748) | 16,70 (.657) |

Receptacle Dust Cap

| Shell | Pack of 100 | | ØA |
|-------|-------------|------------------|---------------|
| Size | Part Number | Nomenclature | |
| 14 | 192900-0378 | TNA14DCR0-01B | 28,60 (1.126) |
| 16 | 192900-0379 | TNA16DCR0-01B | 31,70 (1.248) |
| 24 | 192900-0383 | TNA24DCR0-01B | 44,40 (1.748) |
| 16 | 192900-0718 | Trident Dust Cap | 31,70 (1.248) |

Special



Note: Receptacle Dust Caps are also suitable for Ringlock. For other shell sizes please consult the factory.

Flange Type

Jam Nut Type



Panel Gaskets

Flange Type

| Shell Size | Part Number | Nomenclature |
|------------|-------------|---------------|
| 14 | 192900-0565 | TNA14PG01-00B |
| 16 | 192900-0566 | TNA16PG01-00B |
| 24 | 192900-0567 | TNA24PG01-00B |

Jam Nut Type

| Shell Size | Part Number | Nomenclature |
|------------|-------------|---------------|
| 14 | 192900-0457 | TNA14PG03-00B |
| 16 | 192900-0402 | TNA16PG03-00B |
| 24 | 192900-0458 | TNA24PG03-00B |

TNM (Trident Neptune Metal) is specifically designed to meet the needs of systems that require shielding, sealing, and the extra durability of a metal shell. The combination of Trident contacts, membrane seals, and the Universal Shielded Endbell* make TNM both cost effective and easy to assemble. TNM features nickel plated zinc alloy shells and UL 94 V-0 rated thermoplastic insulators. All TNM receptacles are supplied with an interfacial seal to provide sealing between connectors to IP67. In addition, a membrane seal is available for those applications requiring the sealing of discrete wires at the rear of the connector.

In order to seal multicore jacketed cables to connectors an endbell is available. This has 'O' ring sealing to the connector and second seal to the cable jacket. All TNM Circular Connectors are RoHS Compliant.

*Patent pending

Product Features



Applications

- Antennas.
- Industrial electronics.
- Heavy duty equipment.
- Servo Motors.
- Robotics/ Control Panel.
- Industrial Instrumentation.

- Accepts all Trident signal contacts.
- Mixed signal and power contact version.
- Can be sealed to IP67.
- 360° shielding.
- Easy to assemble.
- Recognized under the component program of UL Inc. and CSA.



Performance Specifications

| | |
|-------------------------------------|--|
| Operating Voltage ¹ | Up to 250 V ac rms |
| Contact Current Rating ² | Up to 13 A; Up to 16 A with High Conductivity Contacts; Up to 30 A with Power Contacts; Up to 40 A with D Sub Contacts |
| Operating Temperature | -55°C to +105°C (-67°F to +221°F) |
| Insulation Resistance | 5000MW min. at 500 V dc |
| Durability ³ | Up to 200 Mating Cycles |
| Environmental Sealing | Up to IP67 |
| Flammability | UL 94 V-0 |

Materials and Finishes

| | |
|---------------|--------------------------|
| Shell | Nickel Plated Zinc Alloy |
| Insulator | Black Nylon |
| Coupling Ring | Nickel Plated Brass |
| Seal | Rubber |

¹ Depends on contacts used, layout, and degree of pollution
² Depends on type and number of contacts used
³ Depends on plating and type of contacts used

Test Specifications

The table below summarizes the results of key tests performed. Data is applicable to standard connectors with standard contacts. Variations may affect this data, so please consult factory for further information on your requirements.

| Test | Method | Criteria of Acceptance |
|---------------------------------|---|--|
| Dielectric Withstanding Voltage | 2000 V ac rms | No breakdown |
| Thermal Shock | -55°C to +125°C (-67°F to +257°F), 5 cycles | No physical damage |
| Physical Shock | 40 g's peak, 3 axes, 6 millisecond duration half-sine pulse | No physical damage No loss of continuity > 10 μsec |
| Vibration | 10 g's peak, 10-500 Hz, 9 hours | No physical damage No loss of continuity > 10 μsec |
| Durability | 200 cycles of mating and unmating 200 mating cycles max. | Capable of mating and unmating and meeting contact resistance requirements |
| Salt Spray | 48 hours | Capable of mating and unmating and meeting contact resistance requirements |
| High Temperature Endurance | 1000 hours at 85°C (+185°F), 16 hours at 105°C (+221°F) | Insulation Resistance > 100 MW |
| Humidity Steady State | RH 90-95%, 40°C (+104°F) , 504 hours | Insulation Resistance > 100 MW |



Dimensions shown in mm (inch)
 Specifications and dimensions subject to change

How to Order-Connectors

Typical Nomenclature: TNM 6 U 14 - 0012 S 1 L *

Series

TNM = Trident Neptune Metal

Shell Style

- 0 = Flange Receptacle (4 holes)
- 6 = Plug
- 7 = Jam Nut Receptacle (Shell Size 14 only)

Sealing Class

- S = Grommet and nut
- U = Unsealed

Modification

* = Standard

Packaging

- B = Bulk (100 pcs)
- L = Single Pack

Connector Finish Materials

1 = Standard (Nickel Plated Metal Parts)

Contact Type

- P = Pin
- S = Socket

Shell Size and Contact Arrangement

| Shell Size | | Number of Power Contacts | Number of Signal Contacts |
|------------|---|--------------------------|---------------------------|
| 10 | - | 00 | 04 |
| 12 | - | 00 | 08 |
| 14 | - | 00 | 12 |
| 14 | - | 03 | 03 |
| 14 | - | 03 | 04 |
| 16 | - | 00 | 19 |
| 16 | - | 04 | 00 |

Contact Cavity Arrangements

Mating Face View

Shell Size

Number of Power Contacts

Number of Signal Contacts¹

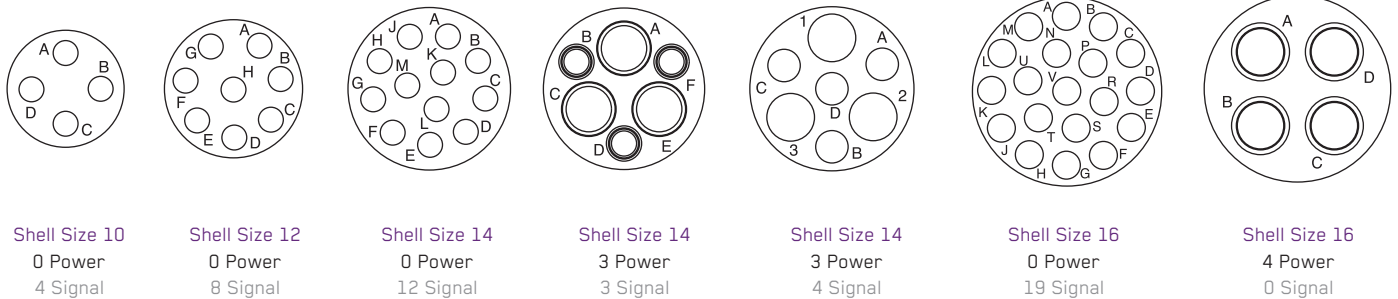

¹ Wire sealing range 1,70 to 2,70 (.066 to .106)



Standard Plugs for Pin Contacts

With Wire Seal and Securing Nut

| Shell Size | Contact Layout | Part Number | Single Piece Connector | | | |
|------------|----------------|-------------|------------------------|---------------|---------------|---------------|
| | | | Nomenclature | A | Ø B | Ø C |
| 10 | 00 04 | 192993-0011 | TNM6S10-0004P1L | 42,50 (1.673) | 17,50 (.689) | 21,60 (.850) |
| 12 | 00 08 | 192993-0012 | TNM6S12-0008P1L | 42,50 (1.673) | 20,60 (.811) | 24,80 (.976) |
| 14 | 03 04 | 192993-0695 | TNM6S14-0304P1L | 42,50 (1.673) | 24,30 (.957) | 28,00 (1.102) |
| 14 | 00 12 | 192993-0013 | TNM6S14-0012P1L | 42,50 (1.673) | 24,30 (.957) | 28,00 (1.102) |
| 16 | 00 19 | 192993-0014 | TNM6S16-0019P1L | 42,50 (1.673) | 27,00 (1.063) | 31,20 (1.229) |

Unsealed – Without Wire Seal and Securing Nut ♦

| Shell Size | Contact Layout | Part Number | Single Piece Connector | | | |
|------------|----------------|-------------|------------------------|---------------|--------------|---------------|
| | | | Nomenclature | A* | Ø B* | Ø C |
| 10 | 00 04 | 192993-0001 | TNM6U10-0004P1L | 38,10 (1.500) | 13,80 (.543) | 21,60 (.850) |
| 12 | 00 08 | 192993-0002 | TNM6U12-0008P1L | 38,10 (1.500) | 16,90 (.665) | 24,80 (.976) |
| 14 | 00 12 | 192993-0003 | TNM6U14-0012P1L | 38,10 (1.500) | 20,10 (.791) | 28,00 (1.102) |
| 16 | 00 19 | 192993-0004 | TNM6U16-0019P1L | 38,10 (1.500) | 23,30 (.917) | 31,20 (1.229) |

* Dimensions A and B apply to connectors without wire seals and securing nuts.
 ♦ Can be sealed to IP67 with a sealed endbell, see page 55.



Panel Cutout



Ø H = Flange in Front of Panel
 Ø G = Flange at Rear of Panel

Standard Receptacles for Socket Contacts Flange Mounting

With Wire Seal and Securing Nut

| Shell Size | Contact Layout | Part Number | Nomenclature | Single Piece Connector | | | | | | | |
|------------|----------------|-------------|-----------------|------------------------|---------------|--------------|---------------|--------------|-------------|---------------|--------------|
| | | | | A | Ø B | Ø C | D | E | Ø F | Ø G | Ø H |
| 10 | 00 04 | 192993-0031 | TNMOS10-0004S1L | 34,70 (1.366) | 17,50 (.689) | 14,92 (.563) | 23,79 (.937) | 18,26 (.719) | 3,20 (.126) | 17,30 (.681) | 15,10 (.594) |
| 12 | 00 08 | 192993-0032 | TNMOS12-0008S1L | 34,70 (1.366) | 20,60 (.811) | 18,98 (.747) | 26,15 (1.030) | 20,62 (.812) | 3,20 (.126) | 21,80 (.858) | 18,20 (.717) |
| 14 | 03 04 | 192993-0698 | TNMOS14-0304S1L | 34,70 (1.366) | 24,30 (.957) | 22,16 (.872) | 28,54 (1.124) | 22,80 (.898) | 3,50 (.138) | 25,00 (.984) | 21,40 (.843) |
| 14 | 00 12 | 192993-0033 | TNMOS14-0012S1L | 34,70 (1.366) | 24,30 (.957) | 22,16 (.872) | 28,54 (1.124) | 22,80 (.898) | 3,50 (.138) | 25,00 (.984) | 21,40 (.843) |
| 16 | 00 19 | 192993-0034 | TNMOS16-0019S1L | 34,70 (1.366) | 27,00 (1.063) | 25,33 (.997) | 30,89 (1.216) | 24,40 (.961) | 3,50 (.138) | 28,10 (1.106) | 24,60 (.969) |

Unsealed - Without Wire Seal and Securing Nut ♦

| Shell Size | Contact Layout | Part Number | Nomenclature | Single Piece Connector | | | | | | | |
|------------|----------------|-------------|-----------------|------------------------|--------------|--------------|---------------|--------------|-------------|---------------|--------------|
| | | | | A* | Ø B* | Ø C | D | E | Ø F | Ø G | Ø H |
| 10 | 00 04 | 192993-0021 | TNMOU10-0004S1L | 30,30 (1.193) | 14,30 (.563) | 14,92 (.563) | 23,79 (.937) | 18,26 (.719) | 3,20 (.126) | 17,30 (.681) | 15,10 (.594) |
| 12 | 00 08 | 192993-0022 | TNMOU12-0008S1L | 30,30 (1.193) | 17,40 (.685) | 18,98 (.747) | 26,15 (1.030) | 20,62 (.812) | 3,20 (.126) | 21,80 (.858) | 18,20 (.717) |
| 14 | 00 12 | 192993-0023 | TNMOU14-0012S1L | 30,30 (1.193) | 20,60 (.811) | 22,16 (.872) | 28,54 (1.124) | 22,80 (.898) | 3,50 (.138) | 25,00 (.984) | 21,40 (.843) |
| 16 | 00 19 | 192993-0024 | TNMOU16-0019S1L | 30,30 (1.193) | 23,80 (.937) | 25,33 (.997) | 30,89 (1.216) | 24,40 (.961) | 3,50 (.138) | 28,10 (1.106) | 24,60 (.969) |

* Dimensions A and B apply to connectors without wire seals and securing nuts.
 ♦ Can be sealed to IP67 with a sealed endbell, see page 50.



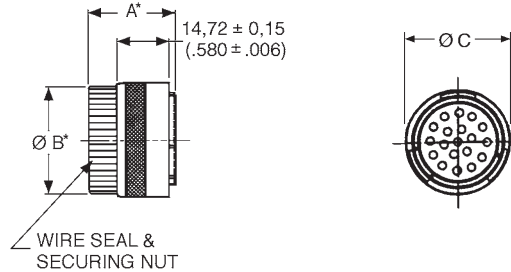

Reversed Plugs for Socket Contacts

With Wire Seal and Securing Nut

| Shell Size | Contact Layout | Single Piece Connector | | A | ØB | ØC |
|------------|----------------|------------------------|-----------------|---------------|---------------|---------------|
| | | Part Number | Nomenclature | | | |
| 10 | 00 04 | 192993-0051 | TNM6S10-0004S1L | 34,20 (1.346) | 17,50 (.689) | 21,60 (.850) |
| 12 | 00 08 | 192993-0052 | TNM6S12-0008S1L | 34,20 (1.346) | 20,60 (.811) | 24,80 (.976) |
| 14 | 03 04 | 192993-0696 | TNM6S14-0304S1L | 34,20 (1.346) | 24,30 (.957) | 28,00 (1.102) |
| 14 | 00 12 | 192993-0053 | TNM6S14-0012S1L | 34,20 (1.346) | 24,30 (.957) | 28,00 (1.102) |
| 16 | 00 19 | 192993-0054 | TNM6S16-0019S1L | 34,20 (1.346) | 27,00 (1.063) | 31,20 (1.229) |

Unsealed – Without Wire Seal and Securing Nut ♦

| Shell Size | Contact Layout | Single Piece Connector | | A* | ØB* | ØC |
|------------|----------------|------------------------|-----------------|---------------|--------------|---------------|
| | | Part Number | Nomenclature | | | |
| 10 | 00 04 | 192993-0041 | TNM6U10-0004S1L | 29,80 (1.173) | 13,80 (.543) | 21,60 (.850) |
| 12 | 00 08 | 192993-0042 | TNM6U12-0008S1L | 29,80 (1.173) | 16,90 (.665) | 24,80 (.976) |
| 14 | 00 12 | 192993-0043 | TNM6U14-0012S1L | 29,80 (1.173) | 20,10 (.791) | 28,00 (1.102) |
| 16 | 00 19 | 192993-0044 | TNM6U16-0019S1L | 29,80 (1.173) | 23,30 (.917) | 31,20 (1.229) |

* Dimensions A and B apply to connectors without wire seals and securing nuts
 ♦ Can be sealed to IP67 with a sealed endbell, see page 55.

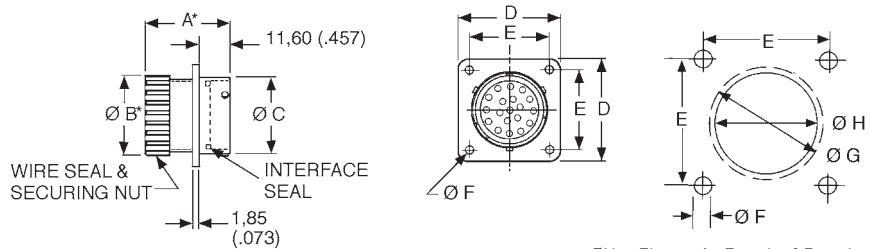

Reversed Receptacles for Pin Contacts Flange Mounting

With Wire Seal and Securing Nut

| Shell Size | Contact Layouts | Single Piece Connector | | A | ØB | ØC | D | E | ØF | ØG | ØH |
|------------|-----------------|------------------------|-----------------|---------------|---------------|--------------|---------------|--------------|-------------|---------------|--------------|
| | | Part Number | Nomenclature | | | | | | | | |
| 10 | 00 04 | 192993-0071 | TNMOS10-0004P1L | 43,00 (1.693) | 17,50 (.689) | 14,92 (.563) | 23,79 (.937) | 18,26 (.719) | 3,20 (.126) | 17,30 (.681) | 15,10 (.594) |
| 12 | 00 08 | 192993-0072 | TNMOS12-0008P1L | 43,00 (1.693) | 20,60 (.811) | 18,98 (.747) | 26,15 (1.030) | 20,62 (.812) | 3,20 (.126) | 21,80 (.858) | 18,20 (.717) |
| 14 | 03 04 | 192993-0697 | TNMOS14-0304P1L | 43,00 (1.693) | 24,30 (.957) | 22,16 (.872) | 28,54 (1.124) | 22,80 (.898) | 3,50 (.138) | 25,00 (.984) | 21,40 (.843) |
| 14 | 00 12 | 192993-0073 | TNMOS14-0012P1L | 43,00 (1.693) | 24,30 (.957) | 22,16 (.872) | 28,54 (1.124) | 22,80 (.898) | 3,50 (.138) | 25,00 (.984) | 21,40 (.843) |
| 16 | 00 19 | 192993-0074 | TNMOS16-0019P1L | 43,00 (1.693) | 27,00 (1.063) | 25,33 (.997) | 30,89 (1.216) | 24,40 (.961) | 3,50 (.138) | 28,10 (1.106) | 24,60 (.969) |

Unsealed - Without Wire Seal and Securing Nut ♦

| Shell Size | Contact Layouts | Single Piece Connector | | A* | ØB* | ØC | D | E | ØF | ØG | ØH |
|------------|-----------------|------------------------|-----------------|---------------|--------------|--------------|---------------|--------------|-------------|---------------|--------------|
| | | Part Number | Nomenclature | | | | | | | | |
| 10 | 00 04 | 192993-0061 | TNMOU10-0004P1L | 38,60 (1.520) | 14,30 (.563) | 14,92 (.563) | 23,79 (.937) | 18,26 (.719) | 3,20 (.126) | 17,30 (.681) | 15,10 (.594) |
| 12 | 00 08 | 192993-0062 | TNMOU12-0008P1L | 38,60 (1.520) | 17,40 (.685) | 18,98 (.747) | 26,15 (1.030) | 20,62 (.812) | 3,20 (.126) | 21,80 (.858) | 18,20 (.717) |
| 14 | 00 12 | 192993-0063 | TNMOU14-0012P1L | 38,60 (1.520) | 20,60 (.811) | 22,16 (.872) | 28,54 (1.124) | 22,80 (.898) | 3,50 (.138) | 25,00 (.984) | 21,40 (.843) |
| 16 | 00 19 | 192993-0064 | TNMOU16-0019P1L | 38,60 (1.520) | 23,80 (.937) | 25,33 (.997) | 30,89 (1.216) | 24,40 (.961) | 3,50 (.138) | 28,10 (1.106) | 24,60 (.969) |

* Dimensions A and B apply to connectors without wire seals and securing nuts
 ♦ Can be sealed to IP67 with a sealed endbell, see page 55.



Standard/Reversed Receptacles for Pin/Socket Contacts
Jam Nut Mounting



- Mates with Standard and Reversed Plugs, see pages 50-51.

With Wire Seal and Securing Nut

| Shell Size | Contact Layout | Type | Single Piece Connector | | A | B | C | ØD | ØE | ØF | ØG |
|------------|----------------|----------|------------------------|-----------------|---------------|-------------|--------------|--------------|--------------|---------------|--------------|
| | | | Part Number | Nomenclature | | | | | | | |
| 14 | 03 04 | Standard | 192993-0700 | TNM7S14-0304S1L | 50,00 (1.968) | 2,80 (.110) | 17,60 (.692) | 22,20 (.874) | 24,30 (.956) | 38,09 (1.500) | 34,90(1.374) |
| 14 | 03 04 | Reversed | 192993-0699 | TNM7S14-0304P1L | 50,00 (1.968) | 2,80 (.110) | 17,60 (.692) | 22,20 (.874) | 24,30 (.956) | 38,09 (1.500) | 34,90(1.374) |



4-way Reversed Plug/Receptacle for Power Contacts

This connector was developed for use on servomotors where high currents and high voltages are used.

- Uses Cannon D Subminiature power contacts, see page 67.
- Voltage rating 500V.
- Current rating 40A.
- Short receptacle to save space.

Single Piece Connector

| Shell Size | Contact Type | Layout | Single Piece Connector | | A | B | C | D | E | F | G | H | I | J |
|------------|---------------------|--------|------------------------|----------------|------|------|------|------|-------|------|------|------|------|-----|
| | | | Part Number | Nomenclature | | | | | | | | | | |
| 16 | Reversed Receptacle | 04 00 | 192993-0106 | TNM192993-0106 | 30,3 | 1,85 | 11,6 | 23,7 | 25,33 | 30,9 | 24,4 | 24,6 | 28,1 | 3,5 |
| 16 | Reversed Plug | 04 00 | 192993-0105 | TNM192993-0105 | 29,8 | 19,1 | 23,2 | 31,2 | | | | | | |
| 16 | Earth Plug | 04 00 | 192993-0109 | TNM192993-0109 | 29,8 | 19,1 | 23,2 | 31,2 | | | | | | |



Dimensions shown in mm (inch)
Specifications and dimensions subject to change



3-3 Connector

Designed for use as an antenna connector, this design incorporates D Subminiature power contacts and standard Trident signal contacts.

- Can terminate wire sizes up to 8 AWG (10 mm²)
- Large cables with outside diameters up to 16,00 (.630) diameter can be accommodated.
- Uses Cannon D Subminiature power contacts see page 67.

For more information, please contact your local Cannon sales office.

| Shell Size | Contact Layouts | Type | Part Number | A | B | C | D | E | F | G | H |
|------------|-----------------|-------------------------|-------------|------|------|-------|------|-------|------|------|------|
| 14 | 03 03 | Reversed Receptacle Pin | 192993-2013 | 38,6 | 2,8 | 17,6 | 18,8 | 22,16 | 34,9 | 24,2 | 25,8 |
| 14 | 03 03 | Reversed Plug Socket | 192993-0261 | 29,8 | 19,1 | 18,85 | 28 | | | | |

How to Order-Accessories



| Accessory Style, Type and Size | | |
|--------------------------------|-------|---|
| Cable Clamp | | |
| CC | HC-00 | Sealed |
| CC | SR-00 | Unsealed |
| CC | SE-00 | Universal Shielded Endbell |
| CC | SE-01 | Shielded Endbell for larger Cable Sizes |
| Heat Shrink Adapter | | |
| HS | AD-00 | Heat Shrink Adapter |



Shielded Endbell for Larger Cable Sizes

- Metal body with plastic cable clamp.
- For assembly instructions, see page 77.
- For use with jacketed cables.

| Shell Size | Part Number | Nomenclature | Ø A max | Cable Accommodation Outer Sheath Diameter | | Ø C | Ø D max |
|------------|-------------|---------------|---------------|---|--------------|--------------|---------------|
| | | | | Ø B min | Ø B max | | |
| 10 | 192993-0091 | TNA10CCSE-01L | 18,10 (.712) | 5,00 (.196) | 10,0 (.393) | 19,00 (.748) | 70,00 (2.755) |
| 12 | 192993-0092 | TNA12CCSE-01L | 21,20 (.834) | 6,00 (.236) | 12,00 (.472) | 21,00 (.826) | 72,00 (2.834) |
| 14 | 192993-0093 | TNA14CCSE-01L | 24,20 (.952) | 7,00 (.275) | 14,00 (.551) | 23,00 (.905) | 78,00 (3.070) |
| 16 | 192993-0094 | TNA16CCSE-01L | 27,60 (1.086) | 8,00 (.314) | 16,00 (.629) | 25,00 (.984) | 82,50 (3.248) |

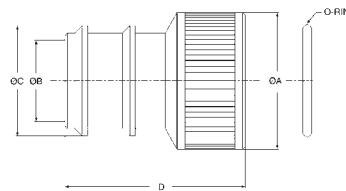

Heat Shrink Adapter for use with TNM Circular Connectors

| Shell Size | Part Number | Nomenclature | Ø Amax | Ø B min | Ø C | Ø Dmax |
|------------|-------------|---------------|---------------|--------------|--------------|---------------|
| | | | | | | |
| 12 | 192993-0632 | TNA12HSAD-00L | 21,20 (.834) | 12,20 (.480) | 18,00 (.708) | 36,00 (1.417) |
| 14 | 192993-0633 | TNA14HSAD-00L | 24,20 (.952) | 14,20 (.559) | 20,00 (.787) | 36,00 (1.417) |
| 16 | 192993-0634 | TNA16HSAD-00L | 27,60 (1.086) | 16,30 (.641) | 22,00 (.866) | 36,50 (1.437) |



Dimensions shown in mm (inch)
Specifications and dimensions subject to change



Universal Shielded Endbell*

In order to meet EMC requirements it will be necessary to fit a shielded endbell to the TNM connectors. The TNM Shielded Endbell provides sealing to the connector shell, a cable braid grip and sealing to the outer sheath of the cable. Sealing rating is IP67.

Shielded endbells are used with unsealed plugs and receptacles.

*Patent Pending

Materials and Finishes

| Description | Material/Finish |
|----------------|------------------|
| Housing | Aluminum/Nickel |
| Grounding Ring | Aluminum/Nickel |
| Clamp Nut | Aluminum/Nickel |
| Cable Grip | Nylon, UL 94 V-0 |
| Support Sleeve | Nylon, UL 94 V-0 |
| O-Ring | Rubber |
| Cable Seal | Rubber |



For assembly instruction, see page 80.

Dimensions

| Shell Size | Part Number | Nomenclature | A | ØB | ØC | D | E max. | |
|------------|-------------|---------------|---------------|--------------|---------------|--------------|-----------------|-----------------|
| | | | | | | | Standard Format | Reversed Format |
| 10 | 192993-0081 | TNA10CCSE-00L | 56,60 (2.228) | 8,00 (.315) | 17,90 (.705) | 16,00 (.630) | 88,50 (3.484) | 80,00 (3.150) |
| 12 | 192993-0082 | TNA12CCSE-00L | 56,70 (2.320) | 10,00 (.394) | 21,00 (.827) | 19,00 (.748) | 88,50 (3.484) | 80,00 (3.150) |
| 14 | 192993-0083 | TNA14CCSE-00L | 57,00 (2.441) | 11,30 (.449) | 24,00 (.945) | 22,00 (.886) | 88,50 (3.484) | 80,00 (3.150) |
| 16 | 192993-0084 | TNA16CCSE-00L | 57,40 (2.260) | 13,60 (.535) | 27,40 (1.079) | 25,00 (.984) | 88,50 (3.484) | 80,00 (3.150) |

Cables

The TNM Shielded Endbell covers a wide range of multicore cable used in industrial applications. The following table indicates the sizes that can be accommodated provided the outside sheath diameter is within the accommodation range shown.

| Endbell Shell Size | Number of Signal Contacts | Cable Accommodation Outer Sheath Size | |
|--------------------|---------------------------|---------------------------------------|--------------|
| | | Minimum | Maximum |
| 10 | 4 | 4,40 (.173) | 7,30 (.287) |
| 12 | 8 | 6,40 (.252) | 9,50 (.374) |
| 14 | 12 | 8,50 (.334) | 10,20 (.402) |
| 16 | 19 | 7,90 (.311) | 12,60 (.496) |

For detail of contacts, see page 59.

Shielded cable to Endbell Assembly Instructions are supplied with the Endbell piece parts kit, also shown on page 76.



Sealed Cable Clamps
for use with TNM Circular
Connectors

* For disassembly, add 9,000 (.0354) for shell sizes 10-16.

- For use with jacketed cables.
- Provides strain relief and wire protection.
- Provides sealing to IP67.
- For assembly instructions, see page 75.

| Shell Size | Part Number | Nomenclature | Dimensions | | | |
|------------|-------------|---------------|--------------|--------------|-----------------|-----------------|
| | | | ØA max. | B | C max. | |
| | | | | | Standard Format | Reversed Format |
| 10 | 192900-0636 | TNA10CCHC-00L | 11,10 (.437) | 18,80 (.740) | 89,00 (3.504) | 80,70 (3.177) |
| 12 | 192900-0637 | TNA12CCHC-00L | 13,60 (.535) | 20,80 (.818) | 92,00 (3.622) | 83,70 (3.295) |
| 14 | 192900-0496 | TNA14CCHC-00L | 14,60 (.574) | 22,80 (.897) | 99,00 (3.898) | 90,70 (3.571) |
| 16 | 192900-0497 | TNA16CCHC-00L | 16,60 (.653) | 24,70 (.972) | 103,00 (4.055) | 94,70 (3.728) |

* Assumes a uniformly cylindrical cable. Variations in the diameter could effect sealing.



* For disassembly, add 9,000 (.0354) for shell sizes 10-16.

Unsealed Cable Clamps
for use with TNM Circular Connectors

- Provides strain relief and wire protection.
- For use with discrete wires or jacketed cables.
- For assembly instructions, see page 75.

| Shell Size | Part Number | Nomenclature | Dimensions | | | | | |
|------------|-------------|---------------|---------------|-------------|--------------|---------------|-----------------|-----------------|
| | | | ØA max. | B | ØC max. | ØD | E max. | |
| | | | | | | | Standard Format | Reversed Format |
| 10 | 192900-0639 | TNA10CCSR-00L | 21,50 (.846) | 6,40 (.251) | 8,70 (.342) | 21,00 (.826) | 74,50 (2.933) | 66,20 (2.606) |
| 12 | 192900-0640 | TNA12CCSR-00L | 24,90 (.980) | 6,40 (.251) | 12,80 (.503) | 24,00 (.944) | 74,50 (2.933) | 66,20 (2.606) |
| 14 | 192900-0286 | TNA14CCSR-00L | 27,00 (1.063) | 6,40 (.251) | 13,80 (.543) | 27,00 (1.063) | 80,50 (3.169) | 71,80 (2.826) |
| 16 | 192900-0343 | TNA16CCSR-00L | 30,10 (1.185) | 6,40 (.251) | 17,00 (.669) | 30,20 (1.189) | 80,50 (3.169) | 71,80 (2.826) |



This connector series is based on the Trident Neptune Metal housing. The insulator body has been designed for high voltage applications. These connectors rated for up to 34 A (for wire size 4,0 mm² at 20°C) and 500 V ac. This connector series is VDE certified.



Performance Specifications

Electrical Data

| | |
|------------------------|---|
| Operating Voltage | Up to 500 V (dc and ac) |
| Contact Current Rating | Max. 34 A for wire size 4,0 mm ² at 20°C |
| Contact Resistance | 5mOhm max. |
| Voltage Proof | 6kV rated impulse voltage |
| Insulation Resistance | 5000MOhm |

Mechanical Data

| | |
|-----------------|--|
| Durability | Up to 200 Mating cycles, depending on contact type |
| Mating Torque | Max. 2,3 Nm |
| Unmating Torque | Min. 0,25 Nm to max. 2,3 Nm |

Environmental Data (acc. ISO 15170)

| | |
|-----------------------|---------------------------------------|
| Operating Temperature | -40°C to +125°C (-40°F to +257°F) |
| Humidity Steady State | RH 90 to 95%, 40°C, 504 hours |
| Environmental Sealing | IP67 in mated condition |
| Salt Spray | 48 hours |
| Vibration | 10 g's peak, 10 to 500 Hz, 9 hours |
| Physical Shock | 40 g's peak, 6msec., half-spine pulse |

Materials and Finishes

| | |
|---------------|--------------------------|
| Shell | Nickel Plated Zinc Alloy |
| Insulator | Orange Nylon |
| Coupling Ring | Nickel Plated Brass |
| Flammability | UL 94 V-0 |



Attention! Connector must not be disconnected under load!



Dimensions: Standard Receptacle



Dimensions: Standard Plug with Endbell



High Voltage 4-way for Power Contacts

- Standard and reversed version available.
- Uses APK Power contacts, see page 61.
- For sealing the receptacle use panel gasket, see page 47.

| Shell Size | Type | Contact Layout | Part Number | Nomenclature |
|------------|------------------------------|----------------|-------------|--------------------|
| 14 | Standard Plug with Endbell* | 04-00 | 192993-0702 | THV6U14-0400P1L-02 |
| 14 | Standard Receptacle* | 04-00 | 192993-0704 | THV0U14-0400S1L-02 |
| 14 | Reversed Plug with Endbell** | 04-00 | 192993-0706 | THV6U14-0400S1L-02 |
| 14 | Reversed Receptacle** | 04-00 | 192993-0708 | THV0U14-0400P1L-02 |

* Parts are VDE-qualified.
 ** Parts are not VDE-qualified.



High Voltage 4-way Jam Nut Receptacle for Power Contacts

Information available upon request.

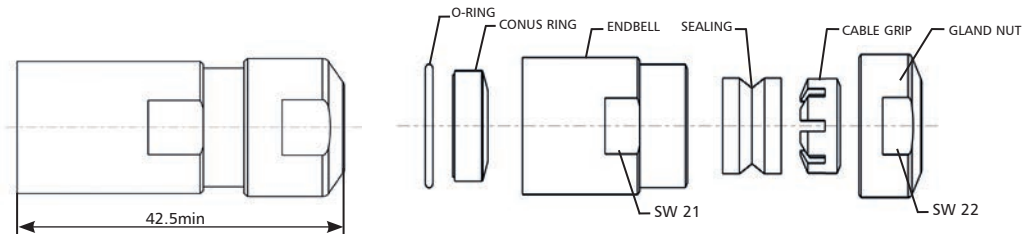

Shielded Endbell

Part Number (Pack of 100)
 192993-0087



Dimensions shown in mm (inch)
 Specifications and dimensions subject to change

General recommendations for the selection of Trident contacts are listed below.

Platings: Tin is recommended for most applications (with 50 or fewer mating cycles). It is cost effective and matches well to most wires. Gold is preferred for special situations. Gold resists oxidation, has high surface conductivity, and has a low coefficient of friction. These features make gold the preferred plating for low level signals (a rule of thumb is <100 mA), corrosive environments (for unsealed connectors), and for increased mating cycles. The electrical performance of the contact is determined at the surface of the contact. For this reason, flash gold platings are suitable for applications with 50 or fewer mating cycles. Thicker gold platings are recommended for more than 50 mating cycles. All Trident Contacts are RoHS Compliant.



Stamped versus Machined: The two part stamped contacts are manufactured to precise tolerances and are field proven. They



can be supplied on reels which lowers assembly costs for volume production. Machined contacts offer improved precision and durability. They are recommended for applications with more than 200 mating cycles.

Crimp versus Solder: Crimp contacts offer improved electrical performance, strain relief and quality control compared to solder cup contacts. Solder cup contacts are recommended for low

volume and prototype applications where the added cost of crimp tools is not justified.

High Conductivity: These contacts use a different base material than the standard contacts. They are recommended for high current applications. These contacts will also reduce the derating of connectors with several high current lines.

Temperature/Current Rating

Derating curves define the max. current that can be applied to a connector at a given ambient temperature so that the additional temperature rise caused by the current does not exceed the material limit of the connector.

The following curves show the max. currents based on the assumption attached: As factors like current load per contact, wire size etc. may be different in your application. This chart is an indication only.

- Derived in accordance with IEC 512-3, Test 5b.
- Figures are for maximum wire sizes. Smaller wires will reduce rating.
- All contacts equally loaded.
- PCB mounted connectors will be limited by PCB performance.
- Bunched cables will further reduce values.
- Cable insulation type will affect temperature and loading.
- Figures are for maximum connector sizes in each range. Smaller connectors will increase rating.



Dimensions shown in mm (inch)
Specifications and dimensions subject to change

| | T2P <ul style="list-style-type: none"> • Two piece formed (stamped) contact • For up to 200 mating cycles • Full support tooling available | | T3P <ul style="list-style-type: none"> • Three piece machined contact • For up to 500 mating cycles • Full support tooling available | | |
|---|--|---|--|--|---|
| | Standard Crimp  | High Conductivity Crimp  | Machined Crimp  | Solder Cup  | Flow Solder (PCB)  |
| Technical and Performance Data | | | | | |
| Supported wire sizes | AWG 14 to 26 | AWG 14 to 26 | AWG 16 to 26 | AWG 14 to 26 | - |
| Current rating | 13 A | 16 A | 13 A | 13 A | Up to 30 A |
| Contact Resistance (initial) | 5 mW | 5 mW | 5 mW | 5 mW | 5 mW |
| Mechanical endurance | Up to 200 insertions | Up to 200 insertions | Up to 500 insertions | Up to 500 insertions | Up to 500 insertions |
| Body material | Brass | Copper Alloy | Brass | Brass | Brass |
| Retention spring material | Stainless Steel | Stainless Steel | Beryllium Copper | Beryllium Copper | Beryllium Copper |
| Contact retention force (minimum) | 67 N | 67 N | 67 N | 67 N | 67 N |
| Plating Availability | | | | | |
| Tin | Yes | Yes | Yes | Yes | Yes |
| Gold Flash (0,1 μm) | Yes | Yes | Yes | Yes | Yes |
| Gold | 0,75 μm | 0,75 μm | 0,4 μm (pin) 0,75 μm (socket) | 0,4 μm (pin) 0,75 μm (socket) | 0,4 μm (pin) 0,75 μm (socket) |
| Connector/Contact Capability | | | | | |
| Snap Together Rectangular, Slimline (TST) and Flame Retardant (TFR) | Yes | Yes | Yes | Yes | Yes, pre-installed in connectors |
| Ringlock (TR) | Yes | Yes | Yes | Yes | Yes |
| Neptune (TN) | Yes | Yes | Yes | Yes | Yes |
| Neptune Metal (TNM) | Yes | Yes | Yes | Yes | - |
| High Voltage (THV) | — | — | — | — | — |
| Page Number | | | | | |
| | 63 | 63 | 65 | 66 | 66 |

| | | |
|---|---|---|
| | High Power <ul style="list-style-type: none"> • For mixed Neptune and TNM layouts • Full support tooling available | |
| | APK25  | D Sub  |
| Technical and Performance Data | | |
| Supported wire sizes | AWG 12 to 20 | AWG 8 to 14 |
| Current rating | 30 A | Up to 40 A |
| Contact Resistance (initial) | 2,5 mW | * |
| Mechanical endurance | Up to 200 insertions | Up to 500 insertions |
| Body material | Copper Alloy | Copper Alloy |
| Retention spring material | Stainless Steel | * |
| Contact retention force (minimum) | 100 N | * |
| Plating Availability | | |
| Tin | Yes | - |
| Gold Flash (0,1 μm) | - | - |
| Gold | - | 0,76 μm |
| Connector/Contact Capability | | |
| Snap Together Rectangular, Slimline (TST) and Flame Retardant (TFR) | - | - |
| Ringlock (TR) | - | - |
| Neptune (TN) | Yes | - |
| Neptune Metal (TNM) | - | Yes |
| High Voltage (THV) | Yes | — |
| Page Number | | |
| | 67 | 67 |

* For details please consult the factory

Overview - T2P Contacts



Note: This overview shows available options for formed (stamped) T2P contacts. The T2P nomenclature above appears as our description on ITT paperwork, etc, and this is for reference only. To order use the order codes on the following page.

Formed (Stamped) Crimp Contacts – Standard Brass Material

- 13 A current rating.
- Three plating styles available.
- Separate retention spring.
- Up to 200 mating cycles.
- Wide range of wire sizes.
- Full support tooling available, see pages 69-70.
- Two part design.



Size 14 to 16 AWG,
No Insulation Grip

Size 16 to 26 AWG,
Insulation Grip

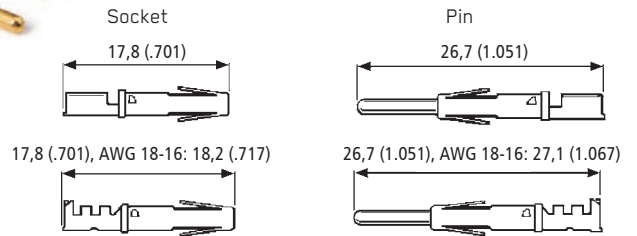

| Wire Range mm ² | Wire Size | Contact | 0,8 mm (32 m in.) | | | | | | Insulation Diameter | Strip Length |
|-------------------------------|-----------|---------|-------------------|-------------|--------------|-------------|-------------|--------------|----------------------------|------------------------|
| | | | Tin Plating | Gold Flash | Gold Plating | Tin Plating | Gold Flash | Gold Plating | | |
| 0,14 - 0,25 | 26-24 AWG | Pin | 192990-0020 | 192990-0080 | 192900-0448 | 192990-2510 | 192990-2650 | 192900-0406 | 0,89 (.035) - 1,58 (.062) | 3,95 (.155)±0,25(.009) |
| 0,14 - 0,25 | 26-24 AWG | Socket | 192990-0030 | 192990-0090 | 192900-0452 | 192990-2550 | 192990-2690 | 192900-0410 | 0,89 (.035) - 1,58 (.062) | 3,95 (.155)±0,25(.009) |
| 0,32 - 0,50 | 22-20 AWG | Pin | 192990-0040 | 192922-1460 | 192900-0447 | 192990-2500 | 192990-2640 | 192900-0405 | 1,17 (.046) - 2,08 (.081) | 3,95 (.155)±0,25(.009) |
| 0,32 - 0,50 | 22-20 AWG | Socket | 192990-0050 | 192922-1470 | 192900-0451 | 192990-2540 | 192990-2680 | 192900-0409 | 1,17 (.046) - 2,08 (.081) | 3,95 (.155)±0,25(.009) |
| 0,75 - 1,50 | 18-16 AWG | Pin | 192990-0060 | 192990-0100 | 192900-0446 | 192990-2490 | 192990-2630 | 192900-0404 | 2,00 (.078) - 2,70 (.106) | 3,95 (.155)±0,25(.009) |
| 0,75 - 1,50 | 18-16 AWG | Socket | 192990-0070 | 192990-0110 | 192900-0450 | 192990-2530 | 192990-2670 | 192900-0408 | 2,00 (.078) - 2,70 (.106) | 3,95 (.155)±0,25(.009) |
| 1,50 - 2,50 | 16-14 AWG | Pin | 192990-1240 | 192990-1220 | 192900-0445 | 192990-2480 | 192990-2620 | 192900-0403 | Without insulation support | 5,60 (.220)±0,25(.009) |
| 1,50 - 2,50 | 16-14 AWG | Socket | 192990-1250 | 192990-1230 | 192900-0449 | 192990-2520 | 192990-2660 | 192900-0407 | Without insulation support | 5,60 (.220)±0,25(.009) |

Formed (Stamped) Crimp Contacts – High Conductivity Material

- 16 A current rating.
- Recommended for elevated temperatures.
- High conductivity copper alloy with tin plating.
- For use with standard crimp tooling, see pages 69-70.
- Two part design.
- Up to 200 mating cycles.



Size 14 to 16 AWG,
No Insulation Grip

Size 16 to 26 AWG,
Insulation Grip



| Wire Range mm ² | Wire Size | Contact | Part Number | | Insulation Diameter | Strip Length |
|-------------------------------|-----------|---------|-------------|---------------|----------------------------|-------------------------|
| | | | Pack (100) | Reeled (3000) | | |
| 0,14 - 0,25 | 26-24 AWG | Pin | 192900-0122 | 192900-0120 | 0,89 (.035) - 1,58 (.062) | 3,95 (.155)±0,25 (.009) |
| 0,14 - 0,25 | 26-24 AWG | Socket | 192900-0123 | 192900-0121 | 0,89 (.035) - 1,58 (.062) | 3,95 (.155)±0,25 (.009) |
| 0,32 - 0,50 | 22-20 AWG | Pin | 192900-0126 | 192900-0124 | 1,17 (.046) - 2,08 (.081) | 3,95 (.155)±0,25 (.009) |
| 0,32 - 0,50 | 22-20 AWG | Socket | 192900-0127 | 192900-0125 | 1,17 (.046) - 2,08 (.081) | 3,95 (.155)±0,25 (.009) |
| 0,75 - 1,50 | 18-16 AWG | Pin | 192900-0002 | 192900-0000 | 2,00 (.078) - 2,70 (.106) | 3,95 (.155)±0,25 (.009) |
| 0,75 - 1,50 | 18-16 AWG | Socket | 192900-0003 | 192900-0001 | 2,00 (.078) - 2,70 (.106) | 3,95 (.155)±0,25 (.009) |
| 1,50 - 2,50 | 16-14 AWG | Pin | 192900-0005 | 192900-0004 | Without insulation support | 5,60 (.220)±0,25 (.009) |
| 1,50 - 2,50 | 16-14 AWG | Socket | 192900-0007 | 192900-0006 | Without insulation support | 5,60 (.220)±0,25 (.009) |

Dimensions shown in mm (inch)
Specifications and dimensions subject to change

Overview - T3P Contacts



| Type and Configuration Variant | | | | |
|--------------------------------|--------|----------------|---|--|
| AWG Size | Gender | Crimp Contacts | | |
| 16 | | C | 1 | No insulation support, Black colorband |
| 20 | | C | 1 | Insulation dia Ø1,6 (.062)-2,1 (.082), Green colorband |
| 22 | | C | 1 | Insulation dia Ø1,6 (.062)-2,15 (.084), Red colorband |
| 24 | | C | 1 | Insulation dia Ø1,05 (.041)-1,6 (.062), Blue colorband |
| 26 | | C | 1 | Insulation dia Ø0,9 (.035)-1,4 (.055), Black colorband |
| Earth Contact | | | | |
| 16 | | E | 1 | Black colorband |
| 20 | | E | 1 | Green colorband |
| Solder Cup Contact | | | | |
| 16 | | S | 1 | |
| Flow Solder Contact | | | | |
| 20 | | F | 1 | Ø0,72 (.028) short (female only) |
| 20 | | F | 3 | Ø0,72 (.028) long (female only) |
| 20 | | F | 5 | Ø0,73 (.029) |
| 25 | | F | 5 | Ø1,52 (.060) (TN) |

Note: This overview shows available options for formed (stamped) T3P contacts. The T3P nomenclature above appears as our description on ITT paperwork, etc, and this is for reference only. To order use the order codes on the following page.

Machined Crimp Contacts

- 13 A current rating.
- Separate contact and retention spring.
- Up to 500 mating cycles.
- Variety of plating options.
- Full support tooling available, see pages 69-70.



Size 16 AWG,
No Insulation Grip

Size 20 to 26 AWG,
Insulation Grip



| Wire Range mm ² | Wire Size | Contact | Part Number (Pack of 100) | | | Insulation Diameter | Strip Length | Color Band |
|-------------------------------|--------------|---------|---------------------------|-----------------|-------------|----------------------------|-------------------------|------------|
| | | | Gold Plating(X) | Gold Plating(Y) | Tin Plating | | | |
| 0,08 - 0,23 | 26 AWG | Pin | 192991-0101 | 192991-0100 | 192991-0102 | 0,90 (.035) - 1,40 (.055) | 5,08 (.200)±0,25 (.009) | Black |
| 0,08 - 0,23 | 26 AWG | Socket | 192991-0054 | 192991-0042 | 192991-0048 | 0,90 (.035) - 1,40 (.055) | 5,08 (.200)±0,25 (.009) | Black |
| 0,20 - 0,24 | 24 AWG | Pin | 192991-0093 | 192991-0092 | 192991-0094 | 1,05 (.041) - 1,60 (.062) | 5,08 (.200)±0,25 (.009) | Blue |
| 0,20 - 0,24 | 24 AWG | Socket | 192991-0055 | 192991-0043 | 192991-0049 | 1,05 (.041) - 1,60 (.062) | 5,08 (.200)±0,25 (.009) | Blue |
| 0,25 - 0,50 | 22 AWG | Pin | 192991-0097 | 192991-0096 | 192991-0098 | 1,60 (.062) - 2,15 (.084) | 5,08 (.200)±0,25 (.009) | Red |
| 0,25 - 0,50 | 22 AWG | Socket | 192991-0056 | 192991-0044 | 192991-0050 | 1,60 (.062) - 2,15 (.084) | 5,08 (.200)±0,25 (.009) | Red |
| 0,44 - 0,64 | 20 AWG | Pin | 192991-0089 | 192991-0088 | 192991-0090 | 1,60 (.062) - 2,10 (.082) | 5,08 (.200)±0,25 (.009) | Green |
| 0,44 - 0,64 | 20 AWG | Socket | 192991-0058 | 192991-0046 | 192991-0052 | 1,60 (.062) - 2,10 (.082) | 5,08 (.200)±0,25 (.009) | Green |
| 0,60 - 1,51 | 16 AWG | Pin | 192991-0085 | 192991-0084 | 192991-0086 | Without insulation support | 7,11 (.279)±0,25 (.009) | Black |
| 0,60 - 1,51 | 16 AWG | Socket | 192991-0059 | 192991-0047 | 192991-0053 | Without insulation support | 7,11 (.279)±0,25 (.009) | Black |
| 1,50 - 2,50 | 14 AWG | Pin | 121587-0028 | on request | on request | Without insulation support | 7,11 (.279)±0,25 (.009) | White |
| 1,50 - 2,50 | 14 AWG | Socket | 121587-0039 | on request | on request | Without insulation support | 7,11 (.279)±0,25 (.009) | White |

(Y) Gold plating Pin: 0,4 μm (16 μ in.). Gold plating Socket: 0,75 μm (30 μ in.).

(X) Gold plating Pin & Socket: 3 μm (120 μ in.).

Machined Earth (First Mate/Last Break) Contacts

- 13 A current rating.
- Separate contact and retention spring.
- Up to 500 mating cycles.
- Variety of plating options.
- Full support tooling available, see pages 69-70.



Size 16 AWG,
No Insulation Grip

Size 20 AWG,
Insulation Grip



| Wire Range mm ² | Wire Size | Contact | Part Number (Pack of 100) | | Insulation Diameter | Strip Length | Color Band |
|-------------------------------|--------------|---------|---------------------------|-------------|----------------------------|-------------------------|---------------|
| | | | Gold Plating(Y) | Description | | | |
| 0,44 - 0,64 | 20 AWG | Pin | 192991-0164 | T3P20ME1LY | 1,60 (.062) - 2,10 (.082) | 5,08 (.200)±0,25 (.009) | Green |
| 0,44 - 0,64 | 20 AWG | Socket | 192991-0207 | T3P20FE1LY | 1,60 (.062) - 2,10 (.082) | 5,08 (.200)±0,25 (.009) | Green |
| 0,60 - 1,51 | 16 AWG | Pin | 192991-0160 | T3P16ME1LY | Without insulation support | 7,11 (.279)±0,25 (.009) | Black |
| 0,60 - 1,51 | 16 AWG | Socket | 192991-0208 | T3P16FE1LY | Without insulation support | 7,11 (.279)±0,25 (.009) | Black |

(Y) Gold plating Pin: 0,4 μm (16 μ in.). Gold plating Socket: 0,75 μm (30 μ in.).
For Gold Flash Plating, please consult the factory.

Dimensions shown in mm (inch)
Specifications and dimensions subject to change

Solder Cup Contacts

- 13 A current rating.
- Ideal for prototypes and small volume applications.
- Fits into all Trident connectors.
- Simple solder, then insert.



| Description | Part Number | |
|-------------|--------------------|--------------------|
| | Tin Plating | Gold Plating (Y) |
| Socket | 192900-0634 | 192900-0635 |
| Pin | 192900-0632 | 192900-0633 |



(Y) Gold plating 0,4 μ m (16 μ in.)

Flow Solder (PCB) Contacts

- 13 A current rating.
- Available in different lengths depending on connector.
- 30 A power version available.



| Connector Series | Type | Part Number (Pack of 100) | | | |
|------------------------------|--------|---------------------------|--------------------|----------------|-----------------|
| | | Tin Plating | Gold Flash Plating | A ±1,00 (.039) | ØB ±0,06 (.002) |
| Ringlock Standard Receptacle | Socket | *** | 192991-0524 | 33,6 (1.323) | 0,72 (.028) |
| Ringlock Standard Receptacle | Socket | *** | 192991-0066 | 26,5 (1.043) | 0,72 (.028) |
| Neptune | Pin | 192900-0465 | 192900-0356 | 40,6 (1.598) | 0,73 (.029) |
| Neptune Power** | Pin | 192991-0617 | 192991-0618 | 40,6 (1.598) | 1,52 (.060) |

** Note: Appearance differs slightly from the picture.
 *** For details please consult the factory

Nominal lengths (x) of Flow Solder Contacts out of the connector*

Ringlock Standard Receptacle

| Shell Size | 192991-0066 | 192991-0524 |
|------------|-------------|-------------|
| 10 | 4,5 (.177) | 11,6 (.456) |
| 12 | 2,7 (.106) | 9,8 (.386) |
| 14 | 4,5 (.177) | 11,6 (.456) |
| 16 | 2,7 (.106) | 9,8 (.386) |
| 18 | 2,7 (.106) | 9,8 (.386) |
| 20 | 3,0 (.118) | 10,1 (.398) |
| 22 | 2,0 (.079) | 9,1 (.358) |
| 24 | 1,2 (.047) | 8,3 (.327) |

Ringlock Reversed Receptacle

| Shell Size | 192991-0119 192991-0122 |
|------------|----------------------------|
| 10 | 4,7 (.177) |
| 12 | 4,7 (.177) |
| 14 | 4,7 (.177) |
| 16 | 4,7 (.177) |
| 18 | 4,7 (.177) |
| 20 | 4,6 (.181) |
| 22 | 4,6 (.181) |
| 24 | 4,6 (.181) |



* For other connector series please consult the factory



Dimensions shown in mm (inch)
 Specifications and dimensions subject to change

APK
Power Contacts

- 30 A current rating.



| Wire Range mm ² | Wire Size | Contact | Description* | Part Number | | Insulation Diameter | Strip Length |
|-------------------------------|--------------|---------|--------------|---------------------------|-----------------------------|---------------------------|-------------------------|
| | | | | Loose (100) Tin Plated | Reeled (3000) Tin Plated | | |
| 0,50 - 1,00 | 20-18 AWG | Pin | APK-PB25A10 | 031-8717-020 | 121668-0000 | 1,40 (.055) - 2,00 (.078) | 5,00 (.196)±0,25 (.009) |
| 0,50 - 1,00 | 20-18 AWG | Socket | APK-SB25A10 | 031-8717-120 | 121668-0100 | 1,40 (.055) - 2,00 (.078) | 5,00 (.196)±0,25 (.009) |
| 1,50 - 2,50 | 16-14 AWG | Pin | APK-PB25A25 | 031-8717-021 | 121668-0001 | 2,00 (.078) - 2,90 (.114) | 5,00 (.196)±0,25 (.009) |
| 1,50 - 2,50 | 16-14 AWG | Socket | APK-SB25A25 | 031-8717-121 | 121668-0101 | 2,00 (.078) - 2,90 (.114) | 5,00 (.196)±0,25 (.009) |
| 2,50 - 4,00 | 14-12 AWG | Pin | APK-PB25A40 | 031-8717-022 | 121668-0002 | 2,90 (.114) - 3,60 (.141) | 5,00 (.196)±0,25 (.009) |
| 2,50 - 4,00 | 14-12 AWG | Socket | APK-SB25A40 | 031-8717-122 | 121668-0102 | 2,90 (.114) - 3,60 (.141) | 5,00 (.196)±0,25 (.009) |

* Referring to reeled contacts

D Subminiature Loose Contacts, Size 8- High Power-Crimp

Plug

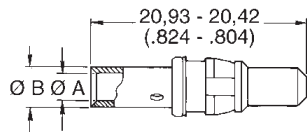
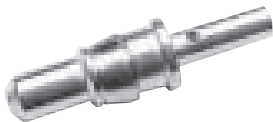

Recommended Wire Trim Length



| Part Number (30 μin) 0,76μm Gold over Copper | A | B | Current | Wire Size |
|--|-------------|-------------|-------------|-----------|
| | | | Rating A | AWG |
| DM130338 | 4,60 (.181) | 5,84 (.230) | 40 A | 8 AWG |
| DM130339 | 2,54 (.100) | 5,54 (.218) | 20 A | 12 AWG |

Receptacle



Recommended Wire Trim Length

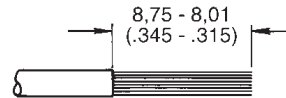

| Part Number (30 μin) 0,76μm Gold over Copper | A | B | Current | Wire Size |
|--|-------------|-------------|-------------|-----------|
| | | | Rating A | AWG |
| DM130341 | 4,60 (.181) | 5,84 (.230) | 40 A | 8 AWG |
| DM130342 | 2,54 (.100) | 5,54 (.218) | 20 A | 12 AWG |

Accessories



| Description | Part Number | Pack Size |
|---|--------------------|-----------------|
| Discriminating (Keying) Pin, Signal Contacts | 192990-0000 | Bulk Pack (25) |
| Discriminating (Keying) Pin, Power Contacts | 192900-0189 | Bulk Pack (25) |
| Discriminating (Keying) Cap, Pin Contacts | 192990-0010 | Bulk Pack (100) |
| Discriminating (Keying) Peg, Socket Contacts | 192990-7650 | Bulk Pack (100) |

Discriminating (Keying) Pins and Caps

Discriminating (Keying) Pins are used to prevent cross-mating of similar connectors. These pins are used in place of a pin contact. The corresponding socket cavity must be left open. If a socket contact is present, the discriminating pin will prevent mating. There are two types of discriminating pins. Board Mount PCB connectors have caps and pegs. All other connectors have signal or power pins.

Hand Tools
for Formed (Stamped) contacts

Ratcheted Hand Tool



A range of single action, factory calibrated tools are available to support the stamped contacts and 30 A power contacts.

| Signal Contact | Power Contact | Part Number |
|------------------|-------------------------|-------------|
| 14-16 AWG | N/A | 121586-5238 |
| 16-18 AWG | N/A | 121586-5237 |
| 20-22, 24-26 AWG | N/A | 121586-5236 |
| N/A | 12-14, 14-16, 18-20 AWG | 121586-5241 |

Hand Tool
for Machined Contacts



This is a ratcheted, four indent crimptool that is fully adjustable. They crimp all sizes of machined contacts.

| Description | Hand Tool Part Number | Locator |
|-----------------|-----------------------|---------------------------------------|
| Machined Crimp* | 995-0001-585 | 192990-7600 (Calibrated) ¹ |

¹Nomenclature: TH-Trident

* M22520-1-01

Extraction Tools



Contacts can readily be removed from the housings using an extraction tool. The tool is placed over the contact and the sleeve rotated slightly as it is pushed home to release the spring. Light pressure on the knob then ejects the contact from the rear of the housing.

| | Part Number |
|--------------------|-------------|
| For Signal Contact | 192922-1450 |
| For Power Contact | 192900-0176 |



| | Part Number |
|-------------------|-------------|
| For Power Contact | 121086-3278 |



Wiring Assist Tool

These wiring needles are available as a wiring aid for high density layouts to ease insertion of individual contacts.

| Description | Part Number |
|--------------------|-------------|
| For Pin Contact | 192900-0605 |
| For Socket Contact | 192900-0606 |



**Mini Applicators
(for Stamped Contacts)**

Mini Applicators are interchangeable modules that will fit into many standard crimping machines. They are available for all sizes of stamped signal and power contacts.

| AWG Size | Contact Description | Mecal Part Number |
|----------|---------------------|-------------------|
| 14-16 | Trident Signal | 121586-5240 |
| 16-18 | Trident Signal | 121586-5217 |
| 20-26 | Trident Signal | 121586-5239 |
| 12-14 | Trident 30 A Power | * |
| 14-16 | Trident 30 A Power | * |
| 18-20 | Trident 30 A Power | * |

* For details please consult the factory



**Testing Gauge
(for Stamped Contacts)**

The testing gauge will be helpful to check whether a crimp is ok or not. The contact should be inserted into the test fixture without scratching the test hole (diameter 3.3 mm).

| Description | Part Number |
|---------------|--------------|
| Testing Gauge | 317-8675-133 |



**Pneumatic Table Crimp Tool
(for Machined Contacts)**

This Hand Crimp Tool fully meets the requirements of specification MIL-C-22520. The tool produces eight-indent crimp terminations of excellent quality. Together with the bench mount BM-2 and the foot pedal WA-10 it becomes an installed tool facilitating the work: The Hands of the operator are free to insert the contact and the wire and to remove the terminated contact.

| Nomenclature | Description | Part Number | AWG |
|--------------|----------------------|-------------|-------|
| WA27F-CE | Pneumatic Crimp Tool | 121586-5067 | 12-20 |
| WA22F-CE | Pneumatic Crimp Tool | 121586-5070 | 20-32 |
| BM-2 | Bench Mount | 121586-5068 | |
| WA10 | Foot Pedal | 121586-5069 | |

Crimping Instructions – Formed (Stamped) Crimp Contacts

Assembly Instructions:

- Strip wires to length. For wire strip lengths, see page 63.
- Open the hand tool and place the contact in the chosen die, ensuring that the locating plate is positioned between the collar and crimp saddle. Then squeeze tool gently to hold the contact in place.
- Insert the wire.
- Cycle the tool.
- Remove the wire and inspect the crimp. The strands should be visible at both ends of the crimp. There should be no loose strands (see Figures 1-3). The contact should be co-linear with the wire (see Figure 4). Bent contacts are unacceptable (see Figure 5).

Figure 1 - Correct

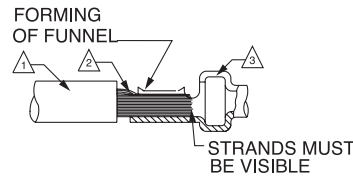

Figure 2 - Unacceptable



Figure 3 - Unacceptable



Figure 4 - Correct

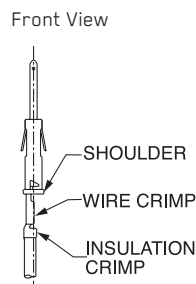

Figure 5 - Unacceptable



Crimping Instructions – Machined Crimp Contacts

Assembly Instructions:

- Strip wires to length. For wire strip lengths, see page 65.
- Attach the correct locator (turret) to the hand tool.

| Contact Type | Locator Color |
|--------------|---------------|
| Pin | Blue |
| Socket | Green |
| Earthing | Black |

- Adjust the dial for the wire gauge.
- Place the contact into the locator and insert the wire into the contact as indicated on the locator (turret) label.

- Cycle the tool.
- Remove and inspect the contact. Strands should be visible through the inspection window (see Figure 6). There should be no loose strands (see Figure 7).

Figure 6 - Correct

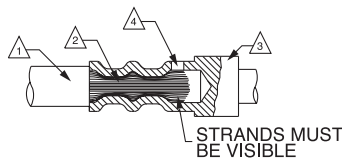
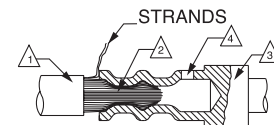

Figure 7 - Unacceptable



Notes:

- Wire Insulation.
- Wire Strands.
- Contact.
- Inspection Window. Strands must be visible.

Dimensions shown in mm (inch)
Specifications and dimensions subject to change

Contact Insertion

No insertion tool is required. Trident contacts are inserted from the rear of the connector and held in place by retention tines (cantilever springs). These tines compress during insertion. They expand once contact is in place and prevent the contact from backing out.

Proper Insertion of Trident Contact



Contact Retention Forces

- Minimum retention force of the contact to the insulator.

| Contact | Newton(s) |
|---|-----------|
| Signal Contacts (Formed Crimp, Machined Crimp, Solder Cup, Flow Solder) | 67 |
| 30 A Power Contacts | 100 |

Note: Newton is a metric unit of force. One pound = 4.45 Newtons

Trident Assembly Instructions

(For Neptune and TNM Assembly, see page 73)

Assembly instructions:

1. Grasp the crimped or soldered contact just behind where the wire enters the contact.
2. Push the contact into the connector cavity until it locks into place.
3. Pull on the wire slightly to verify that the contact is secure.
4. Inspect the mating face of the connector. The contacts should extend the same distance into the connector.

Contact Insertion - Slimline



Contact Insertion - Ringlock



Neptune and TNM Assembly Instructions

Contact Insertion For Neptune and TNM Connectors

(For Trident Assembly, see page 72)

Neptune and TNM connectors feature membrane seals. These seals have a thin membrane that seals unused contact cavities. No sealing plugs are required for unused cavities. Neptune connectors do not require insertion tools. Cannon offers stitching tools as an optional assembly aid for high volume usage. Many customers find that stitching tools reduce the assembly time.

Assembly Instructions:

1. On Neptune and TNM connectors do not remove the Securing Nut holding the Wire Seal in place, unless an accessory such as Metal Endbell, Conduit Adapter, HC or SR Clamp assembly is to be used in its place. Then remove the Securing Nut (to be replaced by the accessory), make sure the tab on the Seal is positioned in the receiving slot in the connector, fit the accessory over the cables/wires and proceed as follows.
2. Grasp the crimped or soldered contact just behind where the wire enters the contact. If using a stitching tool, insert the contact into the rear of the tool.
3. Push the contact through the membrane seal into the insulator. Continue to push until the contact locks into place. If using a stitching tool, first insert the tool into the required contact position in the seal and examine the mating face to confirm that the correct contact cavity has been entered, if not, this can be corrected by partially removing the tool and engaging the correct position. Then fit the contact to the stitching tool and push the CONTACT through until it locks into place; remove the stitching tool.
4. Pull on the wire slightly to verify that the contact is secure.
5. Inspect the mating face of the connector. The contacts should extend the same distance into the connector.
6. Secure the nut, or other accessory, to hold the membrane seal in place.



IMPORTANT NOTE: The stitching tool is not designed to pull the contact through; it is intended to ease the insertion process with high density connectors.

On the high density connectors, such as 0-48, it is beneficial to start loading contacts on a center row first and filling adjacent rows fully each side, so progressively filling the connector from the center in a controlled manner.

Contact Extraction

Contacts may be removed with an extraction tool. The tool has an outer tube and an internal spring loaded plunger. The outer tube depresses the retention tines on the contact. The plunger then pushes the contact back out of the connector.

Extraction Instructions:

1. Grasp the extraction tool on the knurled portion of the outer tube. Do not push on the plunger knob yet.
2. Insert the tube into the contact cavity from the mating surface. Push the tube fully into the cavity.

IMPORTANT: Verify that the depth indicating line on the tool is even with the mating face of the connector before depressing the plunger.

3. Depress the plunger. This should only require light pressure to eject the contact. The contact can now be removed from the back of the connector.
4. Inspect the contact. Verify the tines are not damaged.

Contact Extraction

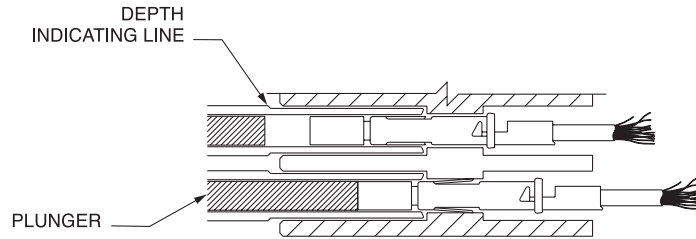

Extraction Tool

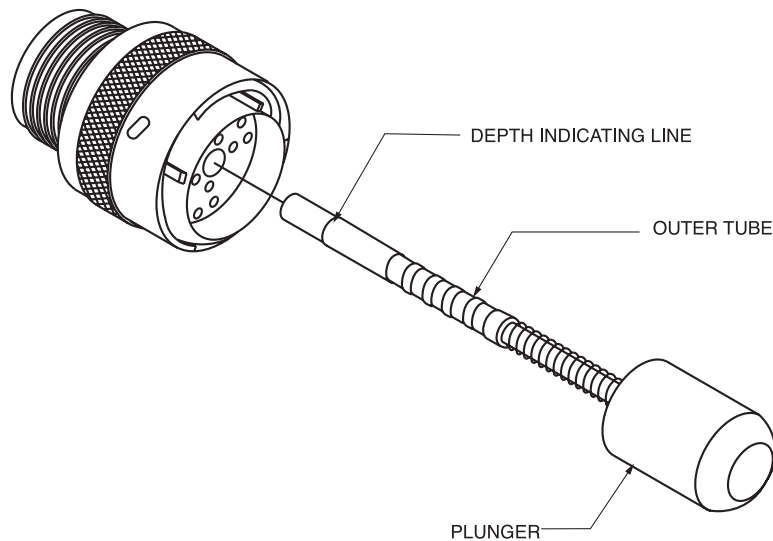

Endbell – Unsealed

Assembly Instructions:

1. Separate the body of the clamp, the two screws, and the clamping bar.
2. Slide the body over the wires or cable and screw onto the threads on the back of the connector. The backshell should be hand-tight. For Neptune and TNM connectors, the cable clamp will fit over the membrane seal and will hold it in place.
3. There are three clamp bars supplied. Select the appropriate one for the wire bundle and attach to the clamp body with the screws.



Endbell – Sealed

Assembly Instructions:

1. Separate the body of the clamp body, the two pressure rings, the sealing grommet, the clamp, and O-ring.
2. Slide the backshell components over the cable prior to crimping the contacts and assembling the connector. The farthest part from the connector is the clamp, followed by a pressure ring, then the grommet, then the other pressure ring, then the clamp body and then the O-ring.

Assembly Note: The grommet is a layered design. For large cables one or more of the interior sections can be removed. If the grommet resists sliding over the cable, lubricate with isopropyl alcohol.

3. Crimp and insert the contacts.
4. Slide the O-ring up and over the back of the connector.
5. Screw the clamp body onto the back of the connector. It should be hand-tight. For Neptune and TNM connectors, the cable clamp will fit over the membrane seal and will hold it in place.
6. Slide the pressure rings and grommet forward into the body.
7. Screw the cable clamp into the clamp body. The cable clamp will apply pressure to the grommet causing it to seal the backshell to the cable.
8. Screw down the clamp bar to secure the cable. Note that the bar is reversible, depending on the size of the cable.



Universal Endbell

Universal Endbell Assembly

The Universal Endbell is suitable to accept shielded and unshielded cable. This cable is sealed with a highly flexible seal and an additional sealing ring with a flexible plastic cable clamp serving as a strain relief. The Universal Endbell can be screwed onto plug and receptacle connectors. The O-ring and the cable sealing meet IP67.

Assembly Instructions:

1. Slide O-ring over the back of the connector body.
2. Slide the endbell components onto the cable in the following order:

- Clamp Nut
- Cable Grip1
- Cable Seal2
- Housing
- Grounding Ring
- Support Sleeve
- O-Ring

Note: 1. The compression fingers of the Cable Grip face toward the connector.

Note: 2. Isopropyl alcohol will lubricate the Cable Seal making it easier to slide over the cable.

3. Cut back the Outside Jacket to expose 25,40 (1.000) of Braid followed by 12,70 (.500) of Insulated Wires.
4. Terminate the wires and insert contacts per assembly instructions, see page 73.
5. Slide the Support Sleeve down until it reaches the back of the connector.
6. Pull the Braid over the Grounding Ring.
7. Slide the Grounding Ring down until it snaps onto the Support Sleeve. The Braid should be secured between the Support Sleeve and the Grounding Ring. Fold any excess shielding over the Grounding Ring.
8. Slide the Housing over the Grounding Ring and the Support Sleeve and screw it into the connector body. The recommended torque is 10 ± 1 Nm (88.50 in lbs).

9. Slide the Cable Seal and Cable Grip onto the Housing.

10. Tighten the Clamp Nut into the Housing. The recommended torque is 10 ± 1 Nm (88.50 in lbs).



Wire Strip Length



| Shell Size | Wire Strip Length | | |
|------------|-------------------|--------------|---|
| | A | B | C |
| 10 | 38,00 (1.500) | 22,00 (.870) | * |
| 12 | 38,00 (1.500) | 22,00 (.870) | * |
| 14 | 40,00 (1.600) | 24,00 (.950) | * |
| 16 | 40,00 (1.600) | 24,00 (.950) | * |

* Strip length will vary based on the contact selected, see page 64-65.

Shielded Endbell for Larger Cable Sizes

This Endbell is an alternative to the Universal Endbell for use with larger diameter cables. The outer body is sealed to the connector with an O-ring and the rear cable clamp also incorporates sealing rings for a complete sealed termination. The cable braid is terminated between metal cones. A rear cable clamp provides mechanical strain relief in addition to the clamping and holding of the rear cable seal.

Assembly Instructions:

1. Assemble all parts onto the cable as shown (Figure 1). Strip sheath of cable to dimensions shown in table below.

| Size | A min. | Dimension Shell |
|------|--------|-----------------|
| 10 | | 22,30 (.877) |
| 12 | | 22,30 (.877) |
| 14 | | 26,20 (1.031) |
| 16 | | 28,10 (1.106) |

2. Fold braid back over cable. Strip and terminate wires with selected contacts (Figure 2).

3. Assemble O-ring in groove of the shell after positioning coupling nut (Figure 3).

Figure 1



Figure 2



Wire Stripping Lengths

| Contact Type | Wire Size | Wire Range mm2 | Dimension B |
|------------------|-----------|----------------|---------------------------|
| Formed contact | 24-16 AWG | 0,08 - 1,50 | 3,95 ± 0,25 (.155 ± .009) |
| | 14 AWG | 1,50 - 2,50 | 5,60 ± 0,25 (.220 ± .009) |
| Machined contact | 26-20 AWG | 0,08 - 0,64 | 5,08 ± 0,25 (.200 ± .009) |
| | 16 AWG | 0,60 - 1,51 | 7,11 ± 0,25 (.279 ± .009) |

Figure 3



Cable Sizes

| Shell Size | Endbell Part Number | Cable Outer Sheath Diameter | |
|------------|---------------------|-----------------------------|-------------|
| | | Maximum | Minimum |
| 10 | 192993-0091 | 10,00 (.393) | 5,00 (.196) |
| 12 | 192993-0092 | 12,00 (.472) | 6,00 (.236) |
| 14 | 192993-0093 | 14,00 (.551) | 7,00 (.279) |
| 16 | 192993-0094 | 16,00 (.629) | 8,00 (.314) |

Shielded Endbell for Larger Cable Sizes

(continued from page 77)

4. Fold braid forward as shown and trim to length (Figure 4).

5. Slide on clamp ring in position shown (Figure 5).

6. Screw clamp body onto the connector using a strap wrench (Figure 6). Tighten to the recommended torque values in table below.

| Shell Size | Clamp body Torque max. |
|------------|------------------------|
| 10 | 4 Nm |
| 12 | 6 Nm |
| 14 | 10 Nm |
| 16 | 10 Nm |

7. Push metal washers and rubber washer into rear of clamp body. Then screw compression nut to compress rubber washer. Avoid overtightening as this may twist the cable. Finally tighten screws to provide the mechanical strain relief (Figure 7).

8. Assembled connector (Figure 8).

Figure 4



Figure 5



Figure 6

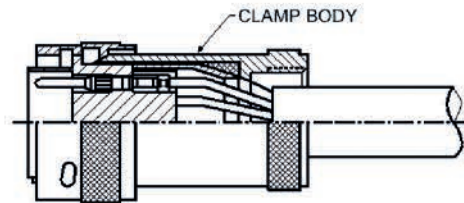

Figure 7



Figure 8



Chart 1 International Protection (IP) ratings for IEC 529

| First digit of IP Number – Ingress of foreign objects | | | Second digit of IP Number – Ingress of water | | | | | | | | |
|---|--|--|--|--|--|---|---|--|---|---------------------------------------|--|
| | | | IP 0 | IP 1 | IP 2 | IP 3 | IP 4 | IP 5 | IP 6 | IP 7 | IP 8 |
| | Meaning for the protection of equipment against ingress of solid foreign objects | Meaning for the protection of persons against access to hazardous parts with | non-protected | Protected against vertically falling water drops | Protected against vertically falling water drops when device is tilted up to 15° | Water sprayed an angle up to 60° on either side of the vertical shall have no harmful effects | Water splashed from any direction shall have no harmful effects | Water projected in jets from any direction shall have no harmful effects | Water projected in powerful jets from any direction shall have no harmful effects | Protected against temporary immersion | Protected against continuous immersion |
| IP 0 | non-protected | non-protected | IP 00 | | | | | | | | |
| IP 1 | Protected against solid foreign objects larger in diameter than 50 mm (1.97 in) | Protected against access to hazardous parts with the back of the hand | IP 10 | IP 11 | IP 12 | | | | | | |
| IP 2 | Protected against solid foreign objects larger in diameter than 12.5 mm (.49 in) | Protected against access to hazardous parts with a finger | IP 20 | IP 21 | IP 22 | IP 23 | | | | | |
| IP 3 | Protected against solid foreign objects larger in diameter than 2.5 mm (.10 in.) | Protected against access to hazardous parts with a tool larger in diameter than 2.5 mm (.10 in.) | IP 30 | IP 31 | IP 32 | IP 33 | IP 34 | | | | |
| IP 4 | Protected against solid foreign objects larger in diameter than 1.0 mm (.04 in.) | Protected against access to hazardous parts with a wire larger in diameter than 1.0 mm (.04 in.) | IP 40 | IP 41 | IP 42 | IP 43 | IP 44 | | | | |
| IP 5 | Ingress of dust is not totally prevented, but dust shall not penetrate in a quantity to interfere with satisfactory operation of the apparatus or to impair safety | Protected against access to hazardous parts with a wire larger in diameter than 1.0 mm (.04 in.) | | | | | IP 54 | IP 55 | | | |
| IP 6 | No ingress of dust | Protected against access to hazardous parts with a wire larger in diameter than 1.0 mm (.04 in.) | | | | | | | IP 66 | IP 67 | IP 68 |

Dimensions shown in mm (inch)
 Specifications and dimensions subject to change

Chart 2 NEMA / IP Cross Reference

| IEC 529 Protection Ratings | NEMA Ratings | | | | | | | | | |
|-------------------------------|--------------|---|---|----|---|----|---|---|----|----|
| | 1 | 2 | 3 | 3R | 4 | 4X | 5 | 6 | 12 | 13 |
| IP 00 | | | | | | | | | | |
| IP 10 | ↓ | | | | | | | | | |
| IP 11 | | ↓ | | | | | | | | |
| IP 20 | | | | | | | | | | |
| IP 21 | | | | | | | | | | |
| IP 22 | | | | | | | | | | |
| IP 23 | | | | | | | | | | |
| IP 30 | | | | | | | | | | |
| IP 31 | | | | | | | | | | |
| IP 32 | | | | ↓ | | | | | | |
| IP 33 | | | | | | | | | | |
| IP 40 | | | | | | | | | | |
| IP 41 | | | | | | | | | | |
| IP 42 | | | | | | | | | | |
| IP 43 | | | | | | | | | | |
| IP 50 | | | | | | | | | | |
| IP 51 | | | | | | | ↓ | | | |
| IP 52 | | | | | | | | | | |
| IP 53 | | | | | | | | | | |
| IP 54 | | | | | | | | | ↓ | ↓ |
| IP 55 | | | | | | | | | | |
| IP 56 | | | | | | | | | | |
| IP 60 | | | | | | | | | | |
| IP 61 | | | | | | | | | | |
| IP 62 | | | | | | | | | | |
| IP 63 | | | ↓ | | | | | | | |
| IP 64 | | | | | | | | | | |
| IP 65 | | | | | | | | | | |
| IP 66 | | | | | | | | | | |
| IP 67 | | | | | ↓ | ↓ | | | | |
| IP 68 | | | | | | | | ↓ | | |

The chart above provides a cross-reference from NEMA to International Protection (IP) Ratings. This cross-reference is an approximation based on the most current information available. It is not sanctioned by NEMA, IEC, or any other regulatory body. This chart should be used only as a guideline.

GLOSSARY OF TERMS

In every job speciality there are certain words and phrases used by “insiders” which after a time become almost a language unique to that speciality. Trident technology is a typical example of that condition.

This page provides some explanations, in an attempt to clarify some of the terms that are commonly used by engineers and sales staff at Cannon.

The list is not comprehensive, but highlights many of the expressions commonly used. Should you have any comments or additions please contact us. Feedback will be appreciated.

ADAPTER – A device used to modify the accessory threading on the rear of the connector. Typical adapters are used to attach conduit, heat shrink, overmolds, or tubing to the connectors. They are generally used in place of a cable clamp.

AWG – American Wire Gauge. A method of specifying wire diameter. The higher the number, the smaller the diameter (a size 16 AWG wire has a larger diameter than a size 22 AWG).

BAYONET COUPLING – A quick coupling mechanism for mechanically mating and unmating connector halves. The plug half has a coupling nut with internal ramps and the receptacle has three “bayonet” pins. The two halves are mated and unmated by rotating the coupling nut. The two halves are mated and unmated by rotating the coupling nut.

BACKSHELL – See ENDBELL.

BODY – The main portion of the connector made of the shell, insulator, and contacts.

CABLE CLAMP – A rear connector clamping accessory which tightens over a cable or wire bundle to provide strain relief to the cable. The cable clamp may be part of a more elaborate endbell or it may be used alone. Some cable clamps also provide cable jacket sealing using a resilient gland, others provide only strain relief.

CABLE SEAL – An endbell or cable clamp that is used to seal a round jacketed cable as it enters the rear of the connector.

CONTACT – The conductive element in a connector which makes the actual connection between the wire and the mating connector for the purpose of transferring electrical energy. Ideally the contact should add nothing to the circuit. In the real world, however, contacts typically have a small CONTACT RESISTANCE and associated potential drop. Contacts come in many styles such as solder, crimp, printed circuit (PC), to name just those found in this catalog. Also see SOLDER CONTACT, CRIMP CONTACT, STAMPED AND FORMED CONTACT, PIN CONTACT, and SOCKET CONTACT.

CONTACT ALIGNMENT – The overall play that a contact has in the insulator cavity to allow the mating contacts to self align. Also called contact float.

CONTACT ARRANGEMENT – See LAYOUT.

CONTACT CAVITY – A defined hole in the connector insulator into which the contacts fit. The cavities are generally marked with a unique designation or number for ease of identification.

CONTACT RESISTANCE – The maximum amount of resistance which a contact introduces into the connection when carrying a specified current (usually stated in milliohms). When not stated, values are typically given for “Initial” or new contacts. Most specifications also limit the maximum resistance during or after each of a series of extreme tests, such as “Contact Resistance After Corrosion Test”. These figures are typically slightly higher than “Initial”.

CONTACT RETENTION – The maximum allowable axial load which can be applied to a contact from either direction without it being dislodged from the insulator. Usually stated in Newtons or pounds of force (4.45 = 1 lbf).

CONTACT SEPARATION FORCE – The force required to separate a pair of mated contacts. Usually stated in grams or ounces.

CONTACT SIZE – The size of the engaging pin and socket contacts in AWG size or metric diameter of the pin.

CONTACT SPACING – The distance between two centers of adjacent contacts.

COUPLING NUT (Also known as LOCKING RING) – The rotating ring on plug style connectors which mechanically locks the two connec-

tor halves together.

CRIMP CONTACT – A contact which is terminated to a wire by means of mechanical deformation of the receiving area by means of an appropriate tool.

CSA – Abbreviation for Canadian Standards Association.

CURRENT RATING – The maximum current that a particular wire, contact, or connector can accommodate. NOTE: When several wires are used in a single connector or elevated temperature or altitude is involved, derating curves must be applied to these ratings.

DERATING CURVE – A graph of the change in power handling capability of a connector as a function of ambient temperature or altitude. Typically the graphed function is curved, hence the name.

DISCRIMINATION – A method of ensuring that two similar size connectors cannot be mated. This may be achieved by inclusion of discriminating pins, which enter an empty contact cavity, or by other mechanical means.

DISCRIMINATING PINS – See KEYING.

ENDBELL (also known as BACKSHELL) – The outer rear end of the connector, which is attached by means of internal threads or screws. It adapts the connector to its wire connections in a variety of ways. Typical endbells might have cable clamps to secure a wire bundle, ridges for heat shrink tubing, pipe threads, or shield termination mechanisms.

EXTRACTION TOOL – A device used to remove a contact from a connector insulator. The extraction tool is inserted into the mating face of the insulator and the contact comes out the rear, or wire side, of the connector.

FIRST-MAKE LAST-BREAK CONTACT – A contact which is longer than a standard contact or which sits in the insulator in such a way that it mates with the opposing connector half before any of the other contacts. Used to ensure that a ground connection between the connector halves mates before any of the other contacts.

FLANGED RECEPTACLE – The shell of this connector has a square flange with mounting holes at each corner. Mounting holes are usually clearance holes, but may

be threaded. Receptacle flanges may be mounted in front or at the rear of the panel.

FLASH PLATING. – As commonly used in connector terminology, flash refers to extremely thin platings of metal. A flash plating is the minimum thickness required to ensure complete surface coverage. It is typically used on contacts that will have only occasional mating and unmating.

IEC – Abbreviation for the International Electrotechnical Commission. An international organization, which develops standards exclusively for electrical engineering. CENELEC is the equivalent organization at the European level.

INSULATOR – The insulating element into which the contacts are mounted in a connector.

IP67 – One classification from a rating system used in Europe covering the environmental sealing capability of an enclosure. The system uses two digits, the first digit relates to the degrees of protection the connector has from dirt and dust under the conditions defined in the specification. The second digit relates to the degrees of protection it has against moisture. The degree of protection against dirt ranges from 1 (no protection), to 6 (dust tight). Moisture sealing in the specification ranges from 1 (no protection), to 8 (protected against continuous submersion). The classification IP67 states that the connector is “dust-tight” (6), allowing no ingress of dust what-so-ever, and “protected against the effects of immersion” (7), the ingress of water in harmful quantity shall not be possible when the connector is immersed in water under defined conditions of pressure and time.

JAM NUT RECEPTACLE – A receptacle con-

necter that is mounted from the rear side of the panel and is held in place by a large hex nut (jam nut).

KEYING – A method of differentiating a connector if more than one connector with the same sex and layout is to be used in a system. The key is a pin which can be located in a contact cavity or slot. The key will prevent a connector without a matching orifice from mating.

LAYOUT – The number, size, and geometric arrangement of the contacts in a connector. When a connector is said to have a certain “layout” it refers to a specific contact configuration. For example, the Snap Together Connector series has a page of drawings showing the arrangement of the contacts in the insulator. Each of these arrangements can be referred to as a layout.

LOCKING RING – See **COUPLING NUT**.

PIN CONTACT – The contact that has a long shaft at the engagement end which enters the socket contact.

PLUG – The male portion of the connector pair usually employing a coupling nut to secure it to the receptacle half. A Plug may have either pin or socket contacts.

POLARIZATION – Polarization ensures that connector halves engage in such a way that the identified contact cavities always engage each other, A to A etc. The connector is polarized.

POLARIZING PIN – See **KEYING**.

REAR MOUNTING – A receptacle that mounts through the panel from the rear, with its mounting flange inside the equipment. Typically, rear mount receptacles are slightly longer than front mount types to allow for the thickness of

the panel. Flange mount receptacles usually come in front and rear mount versions. All Jam nut receptacles are rear mount.

RECEPTACLE – The connector which mates with the plug. The receptacle has threads, pins or ramps that engage the coupling nut on the plug, locking the two halves together. A receptacle may have either pin or socket contacts.

SHELL – The outside case of a connector into which the insulator and contacts are situated.

SHELL SIZE – A standard system developed for military circular connectors for indicating the diameter of the shell. The system is based upon 1/16” increments, that is, a size 16 shell is one inch in diameter.

SOCKET CONTACT – The contact that has an opening at the engagement end to accept the pin contact.

SOLDER CONTACT – A contact that is terminated to the wire or printed circuit with solder. The alternative is crimp contacts to which a wire is attached by crimping.

SOLDER CUP – The end of a **SOLDER CONTACT** designed to accept a wire, which will then be soldered to the contact.

STAMPED AND FORMED CONTACT – Contacts made by stamping and forming a sheet of metal rather than by machining metal stock.

UL – Abbreviation for Underwriter’s Laboratories, a corporation supported by a group of underwriters for the purpose of establishing safety standards covering certain types of equipment and components in the United States. Product Safety Information

Cannon Trident Connectors

Part Number Index

| Part Number | Page | Part Number | Page | Part Number | Page | Part Number | Page | Part Number | Page |
|--------------|------|-------------|--------|-------------|--------|-------------|------|-------------|--------|
| 031-8717-020 | 67 | 192900-0035 | 38 | 192900-0392 | 37 | 192900-0558 | 40 | 192926-0500 | 29 |
| 031-8717-021 | 67 | 192900-0036 | 37 | 192900-0395 | 42 | 192900-0560 | 40 | 192926-0510 | 29 |
| 031-8717-022 | 67 | 192900-0038 | 38 | 192900-0396 | 42 | 192900-0561 | 36 | 192926-0520 | 29 |
| 031-8717-120 | 67 | 192900-0039 | 37 | 192900-0402 | 47 | 192900-0562 | 40 | 192926-0530 | 29 |
| 031-8717-121 | 67 | 192900-0051 | 36 | 192900-0403 | 63 | 192900-0564 | 40 | 192926-0540 | 29 |
| 031-8717-122 | 67 | 192900-0052 | 40 | 192900-0404 | 63 | 192900-0565 | 47 | 192926-0550 | 29 |
| 075-8543-011 | 30 | 192900-0053 | 39 | 192900-0405 | 63 | 192900-0566 | 47 | 192943-4580 | 69 |
| 075-8543-012 | 30 | 192900-0054 | 39 | 192900-0406 | 63 | 192900-0567 | 47 | 192945-4380 | 68 |
| 075-8543-013 | 30 | 192900-0055 | 39 | 192900-0407 | 63 | 192900-0581 | 39 | 192945-4390 | 68 |
| 075-8543-014 | 30 | 192900-0056 | 39 | 192900-0408 | 63 | 192900-0582 | 41 | 192945-4530 | 68, 69 |
| 075-8543-015 | 30 | 192900-0057 | 39 | 192900-0409 | 63 | 192900-0583 | 42 | 192945-4930 | 68, 69 |
| 075-8543-016 | 30 | 192900-0064 | 41 | 192900-0410 | 63 | 192900-0586 | 42 | 192990-0000 | 56, 69 |
| 075-8543-017 | 30 | 192900-0066 | 42 | 192900-0411 | 12 | 192900-0632 | 66 | 192990-0010 | 63 |
| 075-8543-018 | 30 | 192900-0068 | 42 | 192900-0412 | 12 | 192900-0633 | 66 | 192990-0020 | 63 |
| 120090-0118 | 71 | 192900-0069 | 41 | 192900-0413 | 12 | 192900-0634 | 66 | 192990-0030 | 63 |
| 121086-3278 | 70 | 192900-0071 | 42 | 192900-0414 | 12 | 192900-0635 | 66 | 192990-0040 | 63 |
| 121586-5067 | 71 | 192900-0072 | 41 | 192900-0415 | 12 | 192900-0636 | 56 | 192990-0050 | 63 |
| 121586-5068 | 71 | 192900-0074 | 45 | 192900-0416 | 12 | 192900-0637 | 56 | 192990-0060 | 63 |
| 121586-5069 | 71 | 192900-0075 | 41 | 192900-0417 | 12 | 192900-0639 | 56 | 192990-0070 | 63 |
| 121586-5070 | 71 | 192900-0077 | 42 | 192900-0418 | 13 | 192900-0640 | 56 | 192990-0080 | 63 |
| 121586-5217 | 71 | 192900-0078 | 41 | 192900-0419 | 13 | 192900-0654 | 45 | 192990-0090 | 63 |
| 121586-5236 | 70 | 192900-0092 | 35 | 192900-0420 | 13 | 192900-0664 | 40 | 192990-0100 | 63 |
| 121586-5237 | 70 | 192900-0093 | 35 | 192900-0421 | 13 | 192900-0666 | 30 | 192990-0110 | 63 |
| 121586-5238 | 70 | 192900-0094 | 35 | 192900-0422 | 13 | 192900-0667 | 30 | 192990-0350 | 10 |
| 121586-5239 | 71 | 192900-0096 | 37 | 192900-0423 | 13 | 192900-0668 | 30 | 192990-0360 | 11 |
| 121586-5240 | 71 | 192900-0098 | 38 | 192900-0424 | 13 | 192900-0669 | 30 | 192990-0370 | 10 |
| 121586-5241 | 70 | 192900-0099 | 37 | 192900-0425 | 39 | 192900-0670 | 30 | 192990-0380 | 11 |
| 121587-0010 | 16 | 192900-0101 | 38 | 192900-0428 | 39 | 192900-0671 | 30 | 192990-0400 | 11 |
| 121587-0011 | 16 | 192900-0102 | 37 | 192900-0429 | 39 | 192900-0672 | 30 | 192990-0420 | 11 |
| 121587-0012 | 16 | 192900-0104 | 38 | 192900-0431 | 41 | 192900-0673 | 30 | 192990-0430 | 11 |
| 121587-0013 | 16 | 192900-0105 | 37 | 192900-0434 | 41 | 192900-0676 | 30 | 192990-0440 | 11 |
| 121587-0014 | 16 | 192900-0106 | 39 | 192900-0435 | 41 | 192900-0677 | 30 | 192990-0450 | 11 |
| 121587-0015 | 16 | 192900-0107 | 39 | 192900-0437 | 42 | 192900-0678 | 30 | 192990-0460 | 10 |
| 121587-0016 | 16 | 192900-0108 | 39 | 192900-0438 | 42 | 192900-0679 | 30 | 192990-0470 | 10 |
| 121587-0020 | 16 | 192900-0109 | 39 | 192900-0440 | 42 | 192900-0680 | 30 | 192990-0480 | 10 |
| 121587-0021 | 16 | 192900-0110 | 41 | 192900-0441 | 42 | 192900-0681 | 30 | 192990-0960 | 19 |
| 121587-0022 | 16 | 192900-0113 | 41 | 192900-0445 | 63 | 192900-0682 | 30 | 192990-0970 | 19 |
| 121587-0023 | 16 | 192900-0115 | 42 | 192900-0446 | 63 | 192900-0683 | 30 | 192990-0980 | 19 |
| 121587-0024 | 16 | 192900-0116 | 41 | 192900-0447 | 63 | 192900-0691 | 36 | 192990-0990 | 19 |
| 121587-0025 | 16 | 192900-0118 | 42 | 192900-0448 | 63 | 192900-0692 | 36 | 192990-1000 | 19 |
| 121587-0026 | 16 | 192900-0119 | 41 | 192900-0449 | 63 | 192900-0718 | 47 | 192990-1220 | 63 |
| 121587-0030 | 17 | 192900-0120 | 63 | 192900-0450 | 63 | 192922-1190 | 26 | 192990-1230 | 63 |
| 121587-0031 | 17 | 192900-0121 | 63 | 192900-0451 | 63 | 192922-1200 | 26 | 192990-1240 | 63 |
| 121587-0032 | 17 | 192900-0122 | 63 | 192900-0452 | 63 | 192922-1210 | 26 | 192990-1250 | 63 |
| 121587-0033 | 17 | 192900-0123 | 63 | 192900-0457 | 47 | 192922-1220 | 26 | 192990-1290 | 26 |
| 121587-0034 | 17 | 192900-0124 | 63 | 192900-0458 | 47 | 192922-1230 | 26 | 192990-1300 | 26 |
| 121587-0035 | 17 | 192900-0125 | 63 | 192900-0465 | 66 | 192922-1240 | 26 | 192990-1310 | 26 |
| 121587-0036 | 17 | 192900-0126 | 63 | 192900-0469 | 35 | 192922-1250 | 25 | 192990-1320 | 25 |
| 121587-0040 | 17 | 192900-0127 | 63 | 192900-0473 | 35 | 192922-1260 | 25 | 192990-1330 | 25 |
| 121587-0041 | 17 | 192900-0176 | 70 | 192900-0472 | 35 | 192922-1270 | 25 | 192990-1340 | 25 |
| 121587-0042 | 17 | 192900-0184 | 45 | 192900-0475 | 37 | 192922-1280 | 25 | 192990-1350 | 28 |
| 121587-0043 | 17 | 192900-0185 | 45 | 192900-0478 | 37 | 192922-1290 | 25 | 192990-1360 | 28 |
| 121587-0044 | 17 | 192900-0187 | 45 | 192900-0479 | 37 | 192922-1300 | 25 | 192990-1370 | 28 |
| 121587-0045 | 17 | 192900-0189 | 46, 69 | 192900-0481 | 38 | 192922-1310 | 31 | 192990-1380 | 27 |
| 121587-0046 | 17 | 192900-0226 | 45 | 192900-0484 | 38 | 192922-1320 | 31 | 192990-1390 | 27 |
| 121668-0000 | 71 | 192900-0236 | 39 | 192900-0485 | 35, 38 | 192922-1330 | 31 | 192990-1400 | 27 |
| 121668-0001 | 71 | 192900-0242 | 39 | 192900-0487 | 46 | 192922-1340 | 31 | 192990-1430 | 30 |
| 121668-0002 | 71 | 192900-0241 | 39 | 192900-0488 | 46 | 192922-1350 | 31 | 192990-1440 | 30 |
| 121668-0100 | 71 | 192900-0256 | 41 | 192900-0489 | 46 | 192922-1360 | 31 | 192990-1450 | 30 |
| 121668-0101 | 71 | 192900-0261 | 41 | 192900-0490 | 38 | 192922-1450 | 70 | 192990-1460 | 30 |
| 121668-0102 | 71 | 192900-0262 | 41 | 192900-0493 | 38 | 192922-1460 | 63 | 192990-1470 | 30 |
| 192900-0000 | 63 | 192900-0266 | 42 | 192900-0494 | 38 | 192922-1470 | 63 | 192990-1480 | 30 |
| 192900-0001 | 63 | 192900-0271 | 42 | 192900-0496 | 44, 56 | 192923-5920 | 10 | 192990-1490 | 30 |
| 192900-0002 | 63 | 192900-0286 | 44, 56 | 192900-0497 | 44, 56 | 192923-5930 | 10 | 192990-1500 | 30 |
| 192900-0003 | 63 | 192900-0303 | 35 | 192900-0498 | 44 | 192923-5940 | 10 | 192990-1510 | 31 |
| 192900-0004 | 63 | 192900-0308 | 37 | 192900-0507 | 35 | 192923-5950 | 10 | 192990-1520 | 31 |
| 192900-0005 | 63 | 192900-0313 | 38 | 192900-0508 | 38 | 192923-5960 | 10 | 192990-1530 | 31 |
| 192900-0006 | 63 | 192900-0318 | 35 | 192900-0509 | 37 | 192923-5970 | 10 | 192990-1540 | 31 |
| 192900-0007 | 63 | 192900-0319 | 35 | 192900-0510 | 35 | 192923-5980 | 10 | 192990-1550 | 31 |
| 192900-0012 | 35 | 192900-0323 | 37 | 192900-0511 | 38 | 192923-5990 | 10 | 192990-1560 | 31 |
| 192900-0013 | 35 | 192900-0324 | 37 | 192900-0512 | 37 | 192923-6000 | 10 | 192990-1570 | 31 |
| 192900-0014 | 35 | 192900-0328 | 38 | 192900-0537 | 36 | 192923-6010 | 11 | 192990-1580 | 31 |
| 192900-0015 | 35 | 192900-0329 | 38 | 192900-0538 | 36 | 192923-6020 | 11 | 192990-1590 | 31 |
| 192900-0016 | 35 | 192900-0343 | 44, 56 | 192900-0539 | 36 | 192923-6030 | 11 | 192990-1600 | 31 |
| 192900-0017 | 35 | 192900-0344 | 44 | 192900-0540 | 40 | 192923-6040 | 11 | 192990-1660 | 26 |
| 192900-0024 | 37 | 192900-0353 | 42 | 192900-0541 | 40 | 192923-6050 | 11 | 192990-1670 | 26 |
| 192900-0026 | 38 | 192900-0356 | 66 | 192900-0542 | 40 | 192926-0440 | 28 | 192990-1680 | 26 |
| 192900-0028 | 38 | 192900-0370 | 42 | 192900-0547 | 40 | 192926-0450 | 28 | 192990-1690 | 26 |
| 192900-0029 | 37 | 192900-0378 | 47 | 192900-0548 | 40 | 192926-0460 | 28 | 192990-1700 | 26 |
| 192900-0030 | 37 | 192900-0379 | 47 | 192900-0549 | 36 | 192926-0470 | 28 | 192990-1710 | 26 |
| 192900-0032 | 38 | 192900-0383 | 47 | 192900-0550 | 40 | 192926-0480 | 28 | 192990-1720 | 26 |
| 192900-0033 | 37 | 192900-0388 | 47 | 192900-0557 | 36 | 192926-0490 | 28 | 192990-1730 | 26 |

Dimensions shown in mm (inch)

Specifications and dimensions subject to change

| Part Number | Page | Part Number | Page | Part Number | Page | Part Number | Page | Part Number | Page |
|-------------|------|-------------|------|--------------|--------|--------------------|------|----------------|------|
| 192990-1740 | 26 | 192991-0094 | 65 | 192993-0013 | 50 | TFR04AH10 | 16 | TN6G14-0012P1B | 35 |
| 192990-1760 | 28 | 192991-0096 | 65 | 192993-0014 | 50 | TFR04PA10 | 16 | TN6G14-0012P1L | 35 |
| 192990-1770 | 28 | 192991-0097 | 65 | 192993-0021 | 50 | TFR04PH10 | 17 | TN6G14-0012S1B | 39 |
| 192990-1780 | 28 | 192991-0098 | 65 | 192993-0022 | 50 | TFR04RA10 | 17 | TN6G14-0012S1L | 39 |
| 192990-1790 | 28 | 192991-0100 | 65 | 192993-0023 | 50 | TFR06AH10 | 16 | TN6G16-0019S1B | 39 |
| 192990-1800 | 28 | 192991-0101 | 65 | 192993-0024 | 50 | TFR06PA10 | 16 | TN6G16-0019S1L | 39 |
| 192990-1810 | 28 | 192991-0102 | 65 | 192993-0031 | 50 | TFR06PH10 | 17 | TN6G16-0019P1B | 35 |
| 192990-1820 | 28 | 192991-0119 | 66 | 192993-0032 | 50 | TFR06RA10 | 17 | TN6G16-0019P1L | 35 |
| 192990-1830 | 28 | 192991-0122 | 66 | 192993-0033 | 50 | TFR12AH10 | 16 | TN6G24-0048S1B | 39 |
| 192990-1840 | 28 | 192991-0160 | 65 | 192993-0034 | 50 | TFR12PA10 | 16 | TN6G24-0048S1L | 39 |
| 192990-2480 | 63 | 192991-0164 | 65 | 192993-0041 | 51 | TFR12PH10 | 17 | TN6G24-0048P1B | 35 |
| 192990-2490 | 63 | 192991-0207 | 65 | 192993-0042 | 51 | TFR12RA10 | 17 | TN6G24-0048P1L | 35 |
| 192990-2500 | 63 | 192991-0208 | 65 | 192993-0043 | 51 | TFR24AH10 | 16 | TN6G24-0420P1B | 35 |
| 192990-2510 | 63 | 192991-0213 | 13 | 192993-0044 | 51 | TFR24PA10 | 16 | TN6G24-0420P1L | 35 |
| 192990-2520 | 63 | 192991-0214 | 13 | 192993-0051 | 51 | TFR24PH10 | 17 | TN6G24-0420S1B | 39 |
| 192990-2530 | 63 | 192991-0221 | 13 | 192993-0052 | 51 | TFR24RA10 | 17 | TN6G24-0420S1L | 39 |
| 192990-2540 | 63 | 192991-0222 | 13 | 192993-0053 | 51 | TFR36AH10 | 16 | TN6G24-0428P1B | 35 |
| 192990-2550 | 63 | 192991-0229 | 13 | 192993-0054 | 51 | TFR36PA10 | 16 | TN6G24-0428P1L | 35 |
| 192990-2620 | 63 | 192991-0230 | 13 | 192993-0061 | 51 | TFR36PH10 | 17 | TN6G24-0428S1B | 39 |
| 192990-2630 | 63 | 192991-0237 | 13 | 192993-0062 | 51 | TFR36RA10 | 17 | TN6G24-0428S1L | 39 |
| 192990-2640 | 63 | 192991-0238 | 13 | 192993-0063 | 51 | THV6U14-0400P1L-02 | 58 | TN6G24-1219P1B | 35 |
| 192990-2650 | 63 | 192991-0245 | 13 | 192993-0064 | 51 | THV0U14-0400S1L-02 | 58 | TN6G24-1219P1L | 35 |
| 192990-2660 | 63 | 192991-0246 | 13 | 192993-0071 | 51 | THV6U14-0400S1L-02 | 58 | TN6G24-1219S1B | 39 |
| 192990-2670 | 63 | 192991-0253 | 13 | 192993-0072 | 51 | THV0U14-0400P1L-02 | 58 | TN6G24-1219S1L | 39 |
| 192990-2680 | 63 | 192991-0254 | 13 | 192993-0073 | 51 | TN0G14-0012P1B | 41 | TN6L24-0048P1L | 35 |
| 192990-2690 | 63 | 192991-0261 | 13 | 192993-0074 | 51 | TN0G14-0012P1L | 41 | TN6L24-0048P1B | 35 |
| 192990-3230 | 12 | 192991-0262 | 13 | 192993-0081 | 55 | TN0G14-0012S1B | 37 | TN6L24-0048P2B | 36 |
| 192990-3240 | 12 | 192991-0270 | 12 | 192993-0082 | 55 | TN0G14-0012S1L | 37 | TN6L24-0048P2L | 36 |
| 192990-3250 | 12 | 192991-0271 | 12 | 192993-0083 | 55 | TN0G14-0012P1B | 41 | TN6L24-0048S1B | 39 |
| 192990-3260 | 12 | 192991-0278 | 12 | 192993-0084 | 55 | TN0G14-0012P1L | 41 | TN6L24-0048S1L | 39 |
| 192990-3270 | 12 | 192991-0279 | 12 | 192993-0087 | 58 | TN0G16-0019S1B | 37 | TN6L24-0048S2B | 40 |
| 192990-3280 | 12 | 192991-0286 | 12 | 192993-0091 | 54, 77 | TN0G16-0019S1L | 37 | TN6L24-0048S2L | 40 |
| 192990-3290 | 12 | 192991-0287 | 12 | 192993-0092 | 54, 77 | TN0G24-0048P1B | 41 | TN6S14-0012P1B | 35 |
| 192990-3300 | 13 | 192991-0294 | 12 | 192993-0093 | 54, 77 | TN0G24-0048P1L | 41 | TN6S14-0012P1L | 35 |
| 192990-3310 | 13 | 192991-0295 | 12 | 192993-0094 | 54, 77 | TN0G24-0048S1B | 37 | TN6S14-0012S1B | 39 |
| 192990-3320 | 13 | 192991-0302 | 12 | 192993-0105 | 52 | TN0G24-0048S1L | 37 | TN6S14-0012S1L | 39 |
| 192990-3330 | 13 | 192991-0303 | 12 | 192993-0106 | 52 | TN0G24-0420P1B | 41 | TN6S16-0019P1B | 35 |
| 192990-3340 | 13 | 192991-0310 | 12 | 192993-0109 | 52 | TN0G24-0420P1L | 41 | TN6S16-0019P1L | 35 |
| 192990-3350 | 13 | 192991-0311 | 12 | 192993-0261 | 53 | TN0G24-0420S1B | 37 | TN6S16-0019P2B | 36 |
| 192990-3360 | 13 | 192991-0316 | 20 | 192993-0631 | 54 | TN0G24-0420S1L | 37 | TN6S16-0019P2L | 36 |
| 192990-7650 | 69 | 192991-0317 | 21 | 192993-0632 | 54 | TN0G24-0428P1B | 41 | TN6S16-0019S1B | 39 |
| 192990-9240 | 39 | 192991-0318 | 20 | 192993-0633 | 54 | TN0G24-0428P1L | 41 | TN6S16-0019S1L | 39 |
| 192990-9250 | 41 | 192991-0319 | 21 | 192993-0634 | 54 | TN0G24-0428S1B | 37 | TN6S16-0019S2B | 40 |
| 192990-9380 | 35 | 192991-0320 | 20 | 192993-0695 | 50 | TN0G24-0428S1L | 37 | TN6S16-0019S2L | 40 |
| 192990-9390 | 37 | 192991-0321 | 21 | 192993-0696 | 51 | TN0G24-1219P1B | 41 | TN6S16-0213P1B | 35 |
| 192990-9420 | 37 | 192991-0322 | 20 | 192993-0697 | 51 | TN0G24-1219P1L | 41 | TN6S16-0213P1L | 35 |
| 192990-9430 | 35 | 192991-0323 | 21 | 192993-0698 | 50 | TN0G24-1219S1B | 37 | TN6S16-0213P2B | 36 |
| 192990-9440 | 41 | 192991-0324 | 20 | 192993-0699 | 52 | TN0G24-1219S1L | 37 | TN6S16-0213P2L | 36 |
| 192990-9450 | 39 | 192991-0325 | 21 | 192993-0700 | 52 | TN0L24-0048P1B | 41 | TN6S16-0213S1B | 39 |
| 192990-9460 | 38 | 192991-0337 | 20 | 192993-0702 | 58 | TN0L24-0048P1L | 41 | TN6S16-0213S1L | 39 |
| 192990-9470 | 42 | 192991-0342 | 20 | 192993-0704 | 58 | TN0L24-0048S1B | 37 | TN6S16-0213S2B | 40 |
| 192990-9970 | 39 | 192991-0347 | 20 | 192993-0706 | 58 | TN0L24-0048S1L | 37 | TN6S16-0213S2L | 40 |
| 192990-9980 | 41 | 192991-0354 | 20 | 192993-0708 | 58 | TN0S14-0012P1B | 41 | TN6S24-0048P1B | 35 |
| 192991-0013 | 45 | 192991-0402 | 12 | 192993-2013 | 53 | TN0S14-0012P1L | 41 | TN6S24-0048P1L | 35 |
| 192991-0015 | 45 | 192991-0403 | 12 | 193800-0023 | 48 | TN0S14-0012S1B | 37 | TN6S24-0048P2B | 36 |
| 192991-0018 | 46 | 192991-0524 | 66 | 193800-0024 | 48 | TN0S14-0012S1L | 37 | TN6S24-0048P2L | 36 |
| 192991-0042 | 65 | 192991-0532 | 21 | 193800-0029 | 48 | TN0S16-0019P1B | 41 | TN6S24-0048S1B | 39 |
| 192991-0043 | 65 | 192991-0533 | 21 | 193800-0031 | 48 | TN0S16-0019P1L | 41 | TN6S24-0048S1L | 39 |
| 192991-0044 | 65 | 192991-0534 | 21 | 193877-5630 | 48 | TN0S16-0019S1B | 37 | TN6S24-0048S2B | 40 |
| 192991-0046 | 65 | 192991-0535 | 21 | 193877-5640 | 48 | TN0S16-0019S1L | 37 | TN6S24-0048S2L | 40 |
| 192991-0047 | 65 | 192991-0536 | 20 | 274-7613-000 | 70 | TN0S16-0019P1B | 41 | TN6S24-0420P1B | 35 |
| 192991-0048 | 65 | 192991-0538 | 21 | 317-8675-133 | 71 | TN0S16-0213P1L | 41 | TN6S24-0420P1L | 35 |
| 192991-0049 | 65 | 192991-0617 | 66 | 995-0001-584 | 70 | TN0S16-0213S1B | 37 | TN6S24-0420P2B | 36 |
| 192991-0050 | 65 | 192991-0618 | 66 | 995-0001-585 | 70 | TN0S16-0213S1L | 37 | TN6S24-0420P2L | 36 |
| 192991-0052 | 65 | 192991-0628 | 35 | DM130338 | 67 | TN0S24-0048P1B | 41 | TN6S24-0420S1B | 39 |
| 192991-0053 | 65 | 192991-0640 | 37 | DM130339 | 67 | TN0S24-0048P1L | 41 | TN6S24-0420S1L | 39 |
| 192991-0054 | 65 | 192991-0644 | 38 | DM130341 | 67 | TN0S24-0048S1B | 37 | TN6S24-0420S2B | 40 |
| 192991-0055 | 65 | 192991-0648 | 39 | DM130342 | 67 | TN0S24-0048S1L | 37 | TN6S24-0420S2L | 40 |
| 192991-0056 | 65 | 192991-0652 | 41 | TC1FCLY | 62 | TN0S24-0048P1B | 41 | TN6S24-0428P1L | 35 |
| 192991-0058 | 65 | 192991-0656 | 42 | TC1MCLY | 62 | TN0S24-0420P1L | 41 | TN6S24-0428P2B | 36 |
| 192991-0059 | 65 | 192991-0660 | 36 | TC2FCLY | 62 | TN0S24-0420S2B | 37 | TN6S24-0428P2L | 36 |
| 192991-0066 | 66 | 192991-0664 | 35 | TC2MCLY | 62 | TN0S24-0420S1L | 37 | TN6S24-0428S1B | 39 |
| 192991-0084 | 65 | 192991-0668 | 11 | TFR02AH10 | 16 | TN0S24-0428P1B | 41 | TN6S24-0428S1L | 39 |
| 192991-0085 | 65 | 192991-0673 | 47 | TFR02PA10 | 16 | TN0S24-0428P1L | 41 | TN6S24-0428S2B | 40 |
| 192991-0086 | 65 | 192993-0001 | 50 | TFR02PH10 | 17 | TN0S24-0428S1B | 37 | TN6S24-0428S2L | 40 |
| 192991-0088 | 65 | 192993-0002 | 50 | TFR02RA10 | 17 | TN0S24-0428S1L | 37 | TN6S24-1219P1B | 35 |
| 192991-0089 | 65 | 192993-0003 | 50 | TFR03AH10 | 16 | TN0S24-1219P1B | 41 | TN6S24-1219P1L | 35 |
| 192991-0090 | 65 | 192993-0004 | 50 | TFR03PA10 | 16 | TN0S24-1219P1L | 41 | TN6S24-1219P2B | 36 |
| 192991-0092 | 65 | 192993-0011 | 50 | TFR03PH10 | 17 | TN0S24-1219S1B | 37 | | |
| 192991-0093 | 65 | 192993-0012 | 50 | TFR03RA10 | 17 | TN0S24-1219S1L | 37 | | |



Cannon Trident Connector

Part Number Index

| Part Number | Page | Part Number | Page | Part Number | Page | Part Number | Page | Part Number | Page |
|------------------|------|------------------|--------|------------------|------|--------------|------|-------------|------|
| TN6S24-1219P2L | 36 | TN7S16-0019S1L | 38 | TNMOS10-0004P1L | 51 | TR1619RFH1N | 26 | TSTO4RB01Z | 12 |
| TN6S24-1219S1B | 39 | TN7S16-0213P1B01 | 42 | TNMOS10-0004S1L | 50 | TR1619RFS1NB | 26 | TSTO4RB02T | 13 |
| TN6S24-1219S1L | 39 | TN7S16-0213P1L | 42 | TNMOS12-0008P1L | 51 | TR1619RMH1NB | 28 | TSTO4RB02Z | 13 |
| TN6S24-1219S2B | 40 | TN7S16-0213S1B01 | 38 | TNMOS12-0008S1L | 50 | TR1619RMS1NB | 28 | TSTO4RB05T | 12 |
| TN6S24-1219S2L | 40 | TN7S16-0213S1L | 38 | TNMOS14-0012P1L | 51 | TR18AAD | 30 | TSTO4RB05Y | 12 |
| TN6S24-0420P2L | 32 | TN7S16-0213P1B01 | 42 | TNMOS14-0012S1L | 50 | TR18AHC1N | 31 | TSTO4RB06T | 13 |
| TN6S24-0428P2L | 32 | TN7S24-0048P1L | 42 | TNMOS14-0304P1L | 51 | TR18ASR1N | 31 | TSTO4RB06Y | 13 |
| TN6U16-0213P1B | 35 | TN7S24-0048S1B01 | 38 | TNMOS14-0304S1L | 50 | TR1807PFS1NB | 27 | TSTO4RD01T | 20 |
| TN6U16-0213P2B | 36 | TN7S24-0048S1L | 38 | TNMOS16-0019P1L | 51 | TR1807PMS1NB | 25 | TSTO4RD01Y | 20 |
| TN6U16-0213P1L | 35 | TN7S24-0420P1B01 | 42 | TNMOS16-0019S1L | 50 | TR1807RFH1NB | 26 | TSTO4RE01T | 21 |
| TN6U16-0213P2L | 36 | TN7S24-0420P1L | 42 | TNMOSU10-0004P1L | 51 | TR1807RFS1NB | 26 | TSTO4RE01Y | 21 |
| TN6U16-0213S1B | 39 | TN7S24-0420S1B01 | 38 | TNMOSU10-0004S1L | 50 | TR1807RMHNB | 28 | TSTO6AH00 | 10 |
| TN6U16-0213S1L | 39 | TN7S24-0420S1L | 38 | TNMOSU12-0008P1L | 51 | TR1807RMS1NB | 28 | TSTO6AS00 | 11 |
| TN6U16-0213S2B | 40 | TN7S24-0428P1B01 | 42 | TNMOSU12-0008S1L | 50 | TR1823PFS1NB | 27 | TSTO6PA00 | 10 |
| TN6U16-0213S2L | 40 | TN7S24-0428P1L | 42 | TNMOSU14-0012P1L | 51 | TR1823PMS1NB | 25 | TSTO6PF00 | 19 |
| TN6U24-0420P1B | 35 | TN7S24-0428S1B01 | 38 | TNMOSU14-0012S1L | 50 | TR1823RFH1NB | 26 | TSTO6RA00 | 11 |
| TN6U24-0420P2B | 36 | TN7S24-0428S1L | 38 | TNMOSU16-0019P1L | 51 | TR1823RFS1NB | 26 | TSTO6RB01T | 12 |
| TN6U24-0420P1L | 35 | TN7S24-1219P1B01 | 42 | TNMOSU16-0019S1L | 50 | TR1823RMH1NB | 28 | TSTO6RB01Z | 12 |
| TN6U24-0420P2L | 36 | TN7S24-1219P1L | 42 | TNM6S10-0004P1L | 50 | TR1823RMS1NB | 28 | TSTO6RB02T | 13 |
| TN6U24-0420S1B | 39 | TN7S24-1219S1B01 | 38 | TNM6S10-0004S1L | 51 | TR20AAD | 30 | TSTO6RB02Z | 13 |
| TN6U24-0420S1L | 37 | TN7S24-1219S1L | 38 | TNM6S12-0008P1L | 50 | TR20AHC1N | 31 | TSTO6RB05T | 12 |
| TN6U24-0420S2B | 40 | TN7U16-0213S1B01 | 38 | TNM6S12-0008S1L | 51 | TR20ASR1N | 31 | TSTO6RB05Y | 12 |
| TN6U24-0420S2L | 40 | TN7U160213S1L | 38 | TNM6S14-0012P1L | 50 | TR2028PFS1NB | 27 | TSTO6RB06T | 13 |
| TN6U24-0428P1B | 35 | TN7U24-0420S1B01 | 38 | TNM6S14-0012S1L | 51 | TR2028PMS1NB | 25 | TSTO6RB06Y | 13 |
| TN6U24-0428P2B | 36 | TN7U24-0420S1L | 38 | TNM6S14-0304P1L | 50 | TR2028RFH1NB | 26 | TSTO6RD01T | 20 |
| TN6U24-0428P1L | 35 | TN7U24-0428P1B01 | 42 | TNM6S14-0304S1L | 51 | TR2028RFS1NB | 26 | TSTO6RD01Y | 20 |
| TN6U24-0428P2L | 36 | TN7U24-0428P1L | 42 | TNM6S16-0019P1L | 50 | TR2028RMH1NB | 28 | TSTO6RE01T | 21 |
| TN6U24-0428S1B | 39 | TN7U24-0428S1B01 | 38 | TNM6S16-0019S1L | 51 | TR2028RMS1NB | 28 | TSTO6RE01Y | 21 |
| TN6U24-0428S1L | 39 | TN7U24-0428S1L | 38 | TNM6U10-0004P1L | 50 | TR22AAD | 30 | TSTO9PF00 | 19 |
| TN6U24-0428S2B | 40 | TN7U24-1219P1B01 | 42 | TNM6U10-0004S1L | 51 | TR22AHC1N | 31 | TSTO9RD01T | 20 |
| TN6U24-0428S2L | 40 | TN7U24-1219P1L | 42 | TNM6U12-0008P1L | 50 | TR22ASR1N | 31 | TSTO9RD01Y | 20 |
| TN6U24-1219P1B | 35 | TN7U24-1219S1B01 | 38 | TNM6U12-0008S1L | 51 | TR2235PFS1NB | 27 | TSTO9RE01T | 21 |
| TN6U24-1219P2B | 36 | TN7U24-1219S1L | 38 | TNM6U14-0012P1L | 50 | TR2235PMS1NB | 25 | TSTO9RE01Y | 21 |
| TN6U24-1219P1L | 35 | TNA10CCHC-00L | 56 | TNM6U14-0012S1L | 51 | TR2235RFH1NB | 26 | TST10PF00 | 19 |
| TN6U24-1219P2L | 36 | TNA10CCSE-00L | 55 | TNM6U16-0019P1L | 50 | TR2235RFS1NB | 26 | TST10RD01T | 20 |
| TN6U24-1219S1B | 39 | TNA10CCSR-00L | 56 | TNM6U16-0019S1L | 51 | TR2235RMH1NB | 28 | TST10RD01Y | 20 |
| TN6U24-1219S1L | 39 | TNA10HSAD-00L | 54 | TNM7S14-0304P1L | 52 | TR2235RMS1NB | 28 | TST10RE01T | 21 |
| TN6U24-1219S2B | 40 | TNA10CCSE-01L | 54 | TNM7S14-0304S1L | 52 | TR24AAD | 30 | TST10RE01Y | 21 |
| TN6U24-1219S2L | 40 | TNA12CCHC-00L | 56 | TP03R3E00Y | 13 | TR24AHC1N | 31 | TST12AH00 | 10 |
| TN7G14-0012P1B01 | 42 | TNA12CCSE-00L | 55 | TP03R4E00Y | 12 | TR24ASR1N | 31 | TST12AS00 | 11 |
| TN7G14-0012P1L | 42 | TNA12CCSR-00L | 56 | TP04R3E00Y | 13 | TR2448PFS1NB | 27 | TST12PA00 | 10 |
| TN7G14-0012S1B01 | 38 | TNA12CCSE-01L | 54 | TP04R4E00Y | 12 | TR2448PMS1NB | 25 | TST12RA00 | 11 |
| TN7G14-0012S1L | 38 | TNA12HSAD-00L | 54 | TP06R3E00Y | 13 | TR2448RFH1NB | 26 | TST12RB01T | 12 |
| TN7G16-0019P1B01 | 42 | TNA14CCHC-00L | 56 | TP06R4E00Y | 12 | TR2448RFS1NB | 26 | TST12RB01Z | 12 |
| TN7G16-0019P1L | 42 | TNA14CCSE-00L | 55 | TP09R3E00Y | 13 | TR2448RMH1NB | 28 | TST12RB02T | 13 |
| TN7G16-0019S1B01 | 38 | TNA14CCSR-00L | 44, 56 | TP09R4E00Y | 12 | TR2448RMS1NB | 28 | TST12RB02Z | 13 |
| TN7G16-0019S1L | 38 | TNA14CCSE-01L | 54 | TP10R3E00Y | 13 | TST24AH00 | 10 | TST12RB05T | 12 |
| TN7G24-0048P1B01 | 42 | TNA14CCSE-01L | 54 | TP10R4E00Y | 12 | TSTO2PA00 | 10 | TST12RB05Y | 12 |
| TN7G24-0048P1L | 42 | TNA14DCP0-00B | 47 | TR10AAD | 30 | TSTO2RA00 | 11 | TST12RB06T | 13 |
| TN7G24-0048S1B01 | 38 | TNA14DCR0-01B | 47 | TR10AHC1N | 31 | TSTO2RB01T | 12 | TST12RB06Y | 13 |
| TN7G24-0048S1L | 38 | TNA14JN00-00B | 46 | TR10ASR1N | 31 | TSTO2RB01Z | 12 | TST24AH00 | 10 |
| TN7G24-0420P1B01 | 42 | TNA14HSAD-00L | 54 | TR1004PFS1NB | 27 | TSTO2RB02T | 13 | TST24AS00 | 11 |
| TN7G24-0420P1L | 42 | TNA14PG01-00 | 47 | TR1004PMS1NB | 25 | TSTO2RB02Z | 13 | TST24PA00 | 10 |
| TN7G24-0420S1B01 | 38 | TNA14PG03-00 | 47 | TR1004RFH1NB | 26 | TSTO2RB05T | 12 | TST24RA00 | 11 |
| TN7G24-0420S1L | 38 | TNA16CA01-20L | 45 | TR1004RFS1NB | 26 | TSTO2RB05Y | 12 | TST24RB01T | 12 |
| TN7G24-0428P1B01 | 42 | TNA16CA02-18L | 45 | TR1004RMH1NB | 28 | TSTO2RB06T | 13 | TST24RB01Z | 12 |
| TN7G24-0428P1L | 42 | TNA16CA22-18L | 41 | TR1004RMS1NB | 28 | TSTO2RB06Y | 13 | TST24RB02T | 13 |
| TN7G24-0428S1B01 | 38 | TNA16CCCHC-00L | 56 | TR12AAD | 30 | TSTO3AH00 | 10 | TST24RB02Z | 13 |
| TN7G24-0428S1L | 38 | TNA16CCSE-00L | 55 | TR12AHC1N | 31 | TSTO3AS00 | 11 | TST24RB05T | 12 |
| TN7G24-1219S1B01 | 38 | TNA16CCSR-00L | 44, 56 | TR12ASR1N | 31 | TSTO3PA00 | 10 | TST24RB05Y | 12 |
| TN7G24-1219P1B01 | 42 | TNA16CCSE-01L | 54 | TR1208PFS1NB | 27 | TSTO3PF00 | 19 | TST24RB06T | 13 |
| TN7G24-1219P1L | 42 | TNA16HSAD-00L | 54 | TR1208PMS1NB | 25 | TSTO3RA00 | 11 | TST24RB06Y | 13 |
| TN7G24-1219S1L | 38 | TNA16DCP0-00B | 47 | TR1208RFH1NB | 26 | TSTO3RB01T | 12 | TST36AH00 | 10 |
| TN7L24-0048P1B01 | 42 | TNA16DCR0-01B | 47 | TR1208RFS1NB | 26 | TSTO3RB01Z | 12 | TST36AS00 | 11 |
| TN7L240048P1L | 42 | TNA16JN00-00B | 46 | TR1208RMH1NB | 28 | TSTO3RB02T | 13 | TST36PA00 | 10 |
| TN7L24-0048S1B01 | 38 | TNA16PG01-00 | 47 | TR1208RMS1NB | 28 | TSTO3RB02Z | 13 | TST36RA00 | 11 |
| TN7L24-0048S1L | 38 | TNA16PG03-00 | 47 | TR14AAD | 30 | TSTO3RB05T | 12 | TST36RB01T | 12 |
| TN7L24-0048P1L | 38 | TNA24CA01-20L | 45 | TR14AHC1N | 31 | TSTO3RB05Y | 12 | TST36RB01Z | 12 |
| TN7U16-0213P1B01 | 42 | TNA24CA01-25L | 45 | TR14ASR1N | 31 | TSTO3RB06T | 13 | TST36RB02T | 13 |
| TN7U16-0213P1L | 42 | TNA24CA02-25L | 45 | TR1412PFS1NB | 27 | TSTO3RB06Y | 13 | TST36RB02Z | 13 |
| TN7U24-0420P1B01 | 42 | TNA24CA02-26L | 45 | TR1412PMS1NB | 25 | TSTO3RD01T | 20 | TST36RB05T | 12 |
| TN7U24-0420P1L | 42 | TNA24CA03-34L | 45 | TR1412RFH1NB | 26 | TSTO3RD01Y | 20 | TST36RB05Y | 12 |
| TN7S14-0012P1B01 | 42 | TNA24CA22-26L | 41 | TR1412RFS1NB | 26 | TSTO3RE01T | 21 | TST36RB06T | 13 |
| TN7S14-0012P1L | 42 | TNA24CCHC-00L | 44 | TR1412RMH1NB | 28 | TSTO3RE01Y | 21 | TST36RB06Y | 13 |
| TN7S14-0012S1B01 | 38 | TNA24CCSR-00L | 44 | TR1412RMS1NB | 28 | TSTO4AH00 | 10 | | |
| TN7S14-0012S1L | 38 | TNA24DCP0-00B | 47 | TR16AAD | 30 | TSTO4AS00 | 11 | | |
| TN7S16-0019P1B01 | 42 | TNA24DCR0-01B | 47 | TR16AHC1N | 31 | TSTO4PA00 | 10 | | |
| TN7S16-0019P1L | 42 | TNA24JN00-00B | 46 | TR16ASR1N | 31 | TSTO4PF00 | 19 | | |
| TN7S16-0019S1B01 | 38 | TNA24PG01-00 | 47 | TR1619PFS1NB | 27 | TSTO4RA00 | 11 | | |
| TN7S16-0019S1L | 38 | TNA24PG03-00 | 47 | TR1619PMS1NB | 25 | TSTO4RB01T | 12 | | |



1. MATERIAL CONTENT AND PHYSICAL FORM

Electrical connectors do not usually contain hazardous materials. They contain conducting and non-conducting materials and can be divided into two groups.

- a) Printed circuit types and low cost audio types which employ all plastic insulators and casings.
- b) Rugged, Fire Barrier and High Reliability types with metal casings and either natural rubber, synthetic rubber, plastic or glass insulating materials. Contact materials vary with type of connector and also application and are usually manufactured from either: Copper, copper alloys, nickel, alumel, chromel or steel. In special applications, other alloys may be specified.

2. FIRE CHARACTERISTICS AND ELECTRIC SHOCK HAZARD

There is no fire hazard when the connector is correctly wired and used within the specified parameters. Incorrect wiring or assembly of the connector or careless use of metal tools or conductive fluids, or transit damage to any of the component parts may cause electric shock or burns. Live circuits must not be broken by separating mated connectors as this may cause arcing, ionization and burning. Heat dissipation is greater at maximum resistance in a circuit. Hot spots may occur when resistance is raised locally by damage, e.g. cracked or deformed contacts, broken strands of wire. Local overheating may also result from the use of the incorrect application tools or from poor quality soldering or slack screw terminals. Overheating may occur if the ratings in the product Data Sheet/Catalog are exceeded and can cause breakdown of insulation and hence electric shock. If heating is allowed to continue it intensifies by further increasing the local resistance through loss of temper of spring contacts, formation of oxide film on contacts and wires and leakage currents through carbonization of insulation and tracking paths. Fire can then result in the presence of combustible materials and this may release noxious fumes. Overheating may not be visually apparent. Burns may result from touching overheated components.

3. HANDLING

Care must be taken to avoid damage to any component parts of electrical connectors during installation and use. Although there are normally no sharp edges, care must be taken when handling certain components to avoid injury to fingers. Electrical connectors may be damaged in transit to the customers, and damage may result in creation of hazards. Products should therefore be examined prior to installation/use and rejected if found to be damaged.

4. DISPOSAL

Incineration of certain materials may release noxious or even toxic fumes.

5. APPLICATION

Connectors with exposed contacts should not be selected for use on the current supply side of an electrical circuit, because an electric shock could result from touching exposed contacts on an unmated connector. Voltages in excess of 30 V ac or 42.5 V dc are potentially hazardous and care should be taken to ensure that such voltages cannot be transmitted in any way to exposed metal parts of the connector body. The connector and wiring should be checked, before making live, to have no damage to metal parts or insulators, no solder blobs, loose strands, conducting lubricants, swarf, or any other undesired conducting particles. Circuit resistance and continuity check should be made to make certain that there are no high resistance joints or spurious conducting paths. Always use the correct application tools as specified in the Data Sheet/Catalog. Do not permit untrained personnel to wire, assemble or tamper with connectors. For operation voltage please see appropriate national regulations.

IMPORTANT GENERAL INFORMATION

(i) Air and creepage paths/Operating voltage. The admissible operating voltages depend on the individual applications and the valid national and other applicable safety regulations.

For this reason the air and creepage path data are only reference values. Observe reduction of air and creepage paths due to PC board and/or harnessing.

(ii) Temperature

All information given are temperature limits. The operation temperature depends on the individual application.

(iii) Other important information

Cannon continuously endeavors to improve their products. Therefore, Cannon products may deviate from the description, technical data and shape as shown in this catalog and data sheets.

ITT Cannon, a brand of ITT INC manufactures the highest quality products available in the marketplace; however these products are intended to be used in accordance with the specifications in this publication. Any use or application that deviates from the stated operating specifications is not recommended and may be unsafe. No information and data contained in this publication shall be construed to create any liability on the part of Cannon. Any new issue of this publication shall automatically invalidate and supersede any and all previous issues.

Product Warranty

A limited warranty applies to Cannon products. In general, except for obligations assumed by Cannon under this warranty, Cannon shall not be liable for any loss, damage, cost of repairs, incidental or consequential damages of any kind, whether or not based on express or implied warranty, contract, negligence or strict liability arising in connection with the design, manufacture, sale, use or repair of the products. Product availability, prices and delivery dates are exclusively subject to our respective order confirmation form; the same applies to orders based on development samples delivered. Please refer to www.ittcannon.com (General Terms of Sale) for the complete text of Cannon's applicable Terms and Conditions, including Warranty.

This publication is not to be construed as an offer. It is intended merely as an invitation to make an offer. By this publication, Cannon does not assume responsibility or any liability for any patent infringements or other rights of third parties which may result from its use.

Reprinting this publication is generally permitted, indicating the source. However, Cannon's prior consent must be obtained in all cases. "Engineered for life" is a registered trademark of ITT INC 2018. All other trademarks or registered trademarks are property of their respective owners. All dates subject to change without notice.

Commodities in this catalog may be controlled for export by the International Traffic in Arms Regulations (ITAR) and Export Administration Regulations (EAR) when specifically designed modified, or configured for articles controlled by the United States Government.



Connect with your ITT Cannon representative today
or visit us at www.ittcannon.com

Connect with the experts

ITT's Cannon brand is a world leader in the design and manufacture of highly engineered connector solutions for multiple end markets.



ENGINEERED FOR LIFE

North America

Irvine
Phone: +1.800.854.3028

Europe

Italy
Phone: +39.02938721

Germany
Phone: +49.7151.699.0

Asia

China
Phone: +86.755.2726.7888

Данный компонент на территории Российской Федерации

Вы можете приобрести в компании MosChip.

Для оперативного оформления запроса Вам необходимо перейти по данной ссылке:

<http://moschip.ru/get-element>

Вы можете разместить у нас заказ для любого Вашего проекта, будь то серийное производство или разработка единичного прибора.

В нашем ассортименте представлены ведущие мировые производители активных и пассивных электронных компонентов.

Нашей специализацией является поставка электронной компонентной базы двойного назначения, продукции таких производителей как XILINX, Intel (ex.ALTERA), Vicor, Microchip, Texas Instruments, Analog Devices, Mini-Circuits, Amphenol, Glenair.

Сотрудничество с глобальными дистрибьюторами электронных компонентов, предоставляет возможность заказывать и получать с международных складов практически любой перечень компонентов в оптимальные для Вас сроки.

На всех этапах разработки и производства наши партнеры могут получить квалифицированную поддержку опытных инженеров.

Система менеджмента качества компании отвечает требованиям в соответствии с ГОСТ Р ИСО 9001, ГОСТ РВ 0015-002 и ЭС РД 009

Офис по работе с юридическими лицами:

105318, г.Москва, ул.Щербаковская д.3, офис 1107, 1118, ДЦ «Щербаковский»

Телефон: +7 495 668-12-70 (многоканальный)

Факс: +7 495 668-12-70 (доб.304)

E-mail: info@moschip.ru

Skype отдела продаж:

moschip.ru

moschip.ru_4

moschip.ru_6

moschip.ru_9