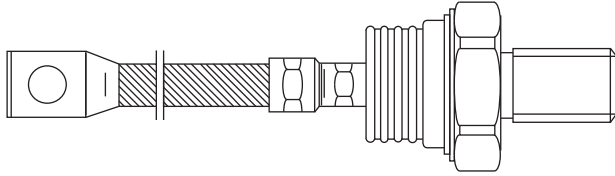

## Standard Recovery Diodes (Stud Version), 600 A

**B-8**
**FEATURES**

- Wide current range
- High voltage ratings up to 3200 V
- High surge current capabilities
- Stud cathode and stud anode version
- Standard JEDEC® types
- Compression bonded encapsulations
- Designed and qualified for industrial level
- Material categorization: For definitions of compliance please see [www.vishay.com/doc?99912](http://www.vishay.com/doc?99912)

**RoHS  
COMPLIANT**
**PRODUCT SUMMARY**

|                       |              |
|-----------------------|--------------|
| $I_{F(AV)}$           | 600 A        |
| Package               | B-8          |
| Circuit configuration | Single Diode |

**TYPICAL APPLICATIONS**

- Converters
- Power supplies
- Machine tool controls
- High power drives
- Medium traction applications

**MAJOR RATINGS AND CHARACTERISTICS**

| PARAMETER    | TEST CONDITIONS | SD600N/R    |              | UNITS             |
|--------------|-----------------|-------------|--------------|-------------------|
|              |                 | 04 to 20    | 22 to 32     |                   |
| $I_{F(AV)}$  |                 | 600         | 600          | A                 |
|              | $T_C$           | 92          | 54           | °C                |
| $I_{F(RMS)}$ |                 | 940         | 940          | A                 |
| $I_{FSM}$    | 50 Hz           | 13 000      | 10 500       |                   |
|              | 60 Hz           | 13 600      | 11 000       |                   |
| $I^2t$       | 50 Hz           | 845         | 551          | kA <sup>2</sup> s |
|              | 60 Hz           | 772         | 503          |                   |
| $V_{RRM}$    | Range           | 400 to 2000 | 2200 to 3200 | V                 |
| $T_J$        |                 | - 40 to 180 | - 40 to 150  | °C                |

**ELECTRICAL SPECIFICATIONS**
**VOLTAGE RATINGS**

| TYPE NUMBER | VOLTAGE CODE | $V_{RRM}$ , MAXIMUM REPETITIVE PEAK REVERSE VOLTAGE<br>V | $V_{RSM}$ , MAXIMUM NON-REPETITIVE PEAK REVERSE VOLTAGE<br>V | $I_{RRM}$ MAXIMUM AT $T_J = T_J$ MAXIMUM<br>mA |
|-------------|--------------|--|--|--|
| VS-SD600N/R | 04           | 400  | 500  | 35   |
|             | 08           | 800  | 900  |  |
|             | 12           | 1200   | 1300   |  |
|             | 16           | 1600   | 1700   |  |
|             | 20           | 2000   | 2100   |  |
|             | 22           | 2200   | 2300   |  |
|             | 28           | 2800   | 2900   |  |
|             | 32           | 3200   | 3300   |  |



| FORWARD CONDUCTION  |               |  |            |                           |                    |        |                   |
|---|---------------|--|------------|---------------------------|--------------------|--------|-------------------|
| PARAMETER   | SYMBOL        | TEST CONDITIONS  | SD600N/R   |                           | UNITS              |        |                   |
|   |               |  | 04 to 20   | 22 to 32                  |                    |        |                   |
| Maximum average forward current at case temperature           | $I_{F(AV)}$   | 180° conduction, half sine wave  | 600        |                           | A                  |        |                   |
|   |               |  | 92         | 54                        | °C                 |        |                   |
|   |               |  | 570        | 375                       | A                  |        |                   |
|   |               |  | 100        |                           | °C                 |        |                   |
| Maximum RMS forward current                                   | $I_{F(RMS)}$  | DC at $T_C = 75\text{ °C}$ (04 to 20), $T_C = 36\text{ °C}$ (25 to 32)                   | 940        |                           |                    |        |                   |
| Maximum peak, one-cycle forward, non-repetitive surge current | $I_{FSM}$     | Sinusoidal half wave, initial $T_J = T_J$ maximum  | t = 10 ms  | No voltage reapplied      | 13 000             | 10 500 | A                 |
|   |               |  | t = 8.3 ms | No voltage reapplied      | 13 600             | 11 000 |                   |
|   |               |  | t = 10 ms  | 100 % $V_{RRM}$ reapplied | 10 900             | 8830   |                   |
|   |               |  | t = 8.3 ms | 100 % $V_{RRM}$ reapplied | 11 450             | 9250   |                   |
| Maximum $I^2t$ for fusing                                     | $I^2t$        | Sinusoidal half wave, initial $T_J = T_J$ maximum  | t = 10 ms  | No voltage reapplied      | 845                | 551    | kA <sup>2</sup> s |
|   |               |  | t = 8.3 ms | No voltage reapplied      | 772                | 503    |                   |
|   |               |  | t = 10 ms  | 100 % $V_{RRM}$ reapplied | 598                | 390    |                   |
|   |               |  | t = 8.3 ms | 100 % $V_{RRM}$ reapplied | 546                | 356    |                   |
| Maximum $I^2\sqrt{t}$ for fusing                              | $I^2\sqrt{t}$ | t = 0.1 to 10 ms, no voltage reapplied   | 8450       | 5510                      | kA <sup>2</sup> √s |        |                   |
| Low level value of threshold voltage                          | $V_{F(TO)1}$  | ( $16.7\% \times \pi \times I_{F(AV)} < I < \pi \times I_{F(AV)}$ ), $T_J = T_J$ maximum | 0.78       | 0.84                      | V                  |        |                   |
| High level value of threshold voltage                         | $V_{F(TO)2}$  | ( $I > \pi \times I_{F(AV)}$ ), $T_J = T_J$ maximum                                      | 0.87       | 0.88                      |                    |        |                   |
| Low level value of forward slope resistance                   | $r_{f1}$      | ( $16.7\% \times \pi \times I_{F(AV)} < I < \pi \times I_{F(AV)}$ ), $T_J = T_J$ maximum | 0.35       | 0.40                      | mW                 |        |                   |
| High level value of forward slope resistance                  | $r_{f2}$      | ( $I > \pi \times I_{F(AV)}$ ), $T_J = T_J$ maximum                                      | 0.31       | 0.38                      |                    |        |                   |
| Maximum forward voltage drop                                  | $V_{FM}$      | $I_{pk} = 1500\text{ A}$ , $T_J = T_J$ maximum, $t_p = 10\text{ ms}$ sinusoidal wave     | 1.31       | 1.44                      | V                  |        |                   |

| THERMAL AND MECHANICAL SPECIFICATIONS        |            |   |             |             |       |
|--|------------|---|-------------|-------------|-------|
| PARAMETER                                    | SYMBOL     | TEST CONDITIONS                               | SD600N/R    |             | UNITS |
|  |            |   | 04 to 20    | 22 to 32    |       |
| Maximum junction operating temperature range | $T_J$      |   | - 40 to 180 | - 40 to 150 | °C    |
| Maximum storage temperature range            | $T_{Stg}$  |   | - 55 to 200 |             |       |
| Maximum thermal resistance, junction to case | $R_{thJC}$ | DC operation                                  | 0.1         |             | K/W   |
| Maximum thermal resistance, case to heatsink | $R_{thCS}$ | Mounting surface, smooth, flat and greased    | 0.04        |             |       |
| Maximum allowed mounting torque ± 10 %       |            | Not-lubricated threads                        | 50          |             | Nm    |
| Approximate weight                           |            |   | 454         |             | g     |
| Case style                                   |            | See dimensions (link at the end of datasheet) | B-8         |             |       |

| $\Delta R_{thJC}$ CONDUCTION |                       |                        |                     |       |
|------------------------------|-----------------------|------------------------|---------------------|-------|
| CONDUCTION ANGLE             | SINUSOIDAL CONDUCTION | RECTANGULAR CONDUCTION | TEST CONDITIONS     | UNITS |
| 180°                         | 0.012                 | 0.008                  | $T_J = T_J$ maximum | K/W   |
| 120°                         | 0.014                 | 0.014                  |                     |       |
| 90°                          | 0.017                 | 0.019                  |                     |       |
| 60°                          | 0.025                 | 0.026                  |                     |       |
| 30°                          | 0.042                 | 0.042                  |                     |       |

Note

- The table above shows the increment of thermal resistance  $R_{thJC}$  when devices operate at different conduction angles than DC



Fig. 1 - Current Ratings Characteristics



Fig. 3 - Current Ratings Characteristics

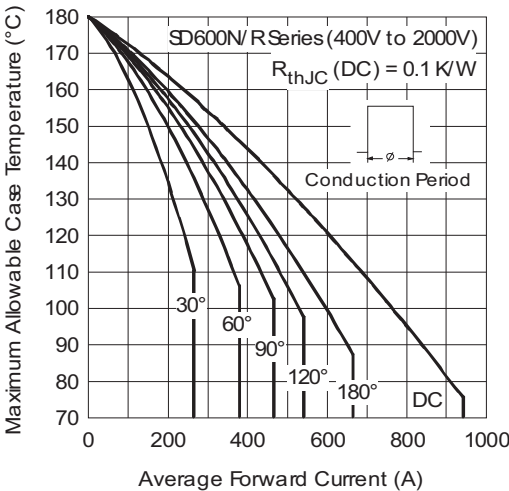

Fig. 2 - Current Ratings Characteristics

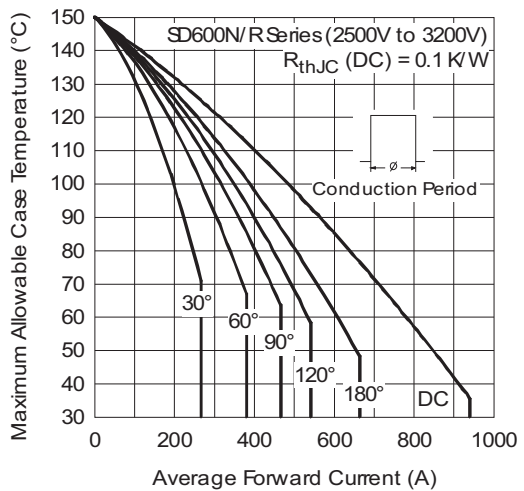

Fig. 4 - Current Ratings Characteristics



Fig. 5 - Forward Power Loss Characteristics



Fig. 6 - Forward Power Loss Characteristics



Fig. 7 - Forward Power Loss Characteristics



Fig. 8 - Forward Power Loss Characteristics

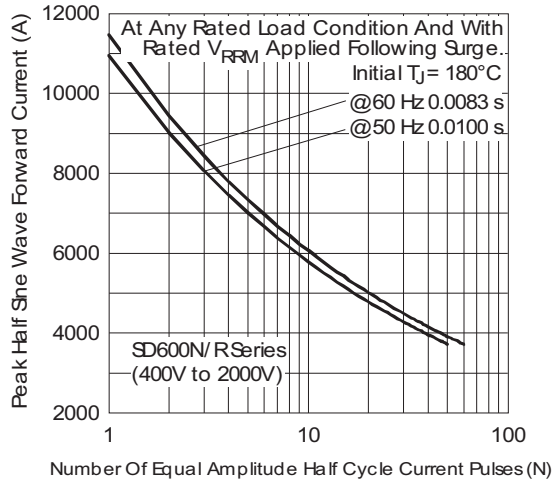

Fig. 9 - Maximum Non-Repetitive Surge Current

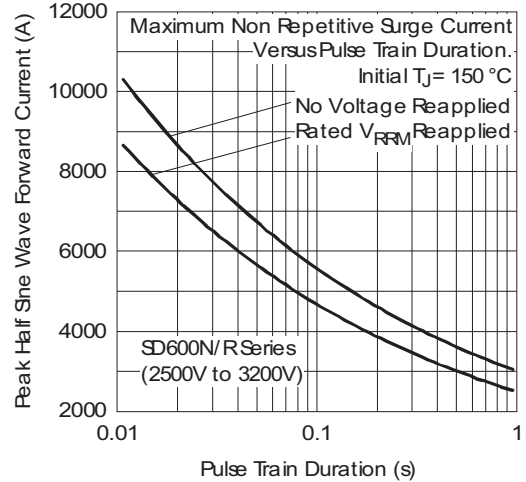

Fig. 12 - Maximum Non-Repetitive Surge Current

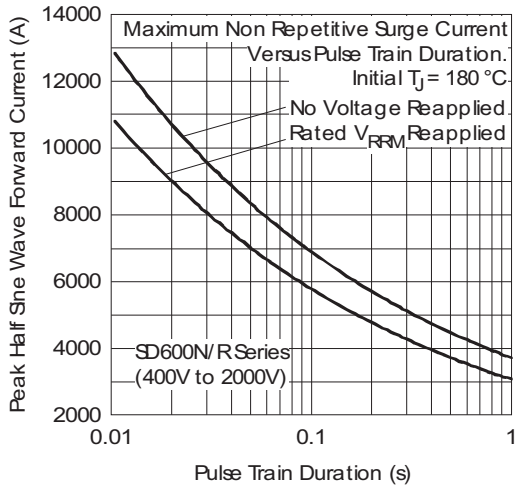

Fig. 10 - Maximum Non-Repetitive Surge Current

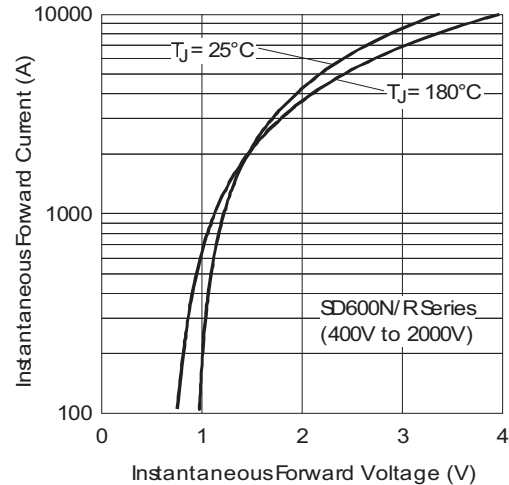

Fig. 13 - Forward Voltage Drop Characteristics

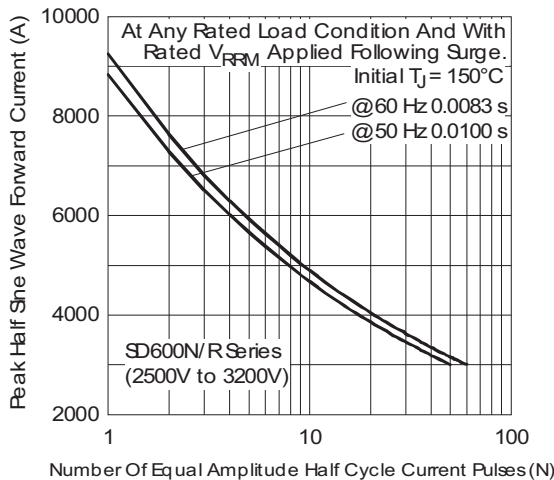

Fig. 11 - Maximum Non-Repetitive Surge Current

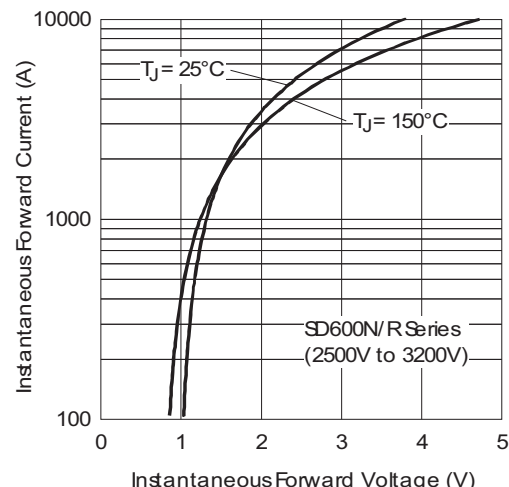

Fig. 14 - Forward Voltage Drop Characteristics



Fig. 15 - Thermal Impedance  $Z_{thJC}$  Characteristics

**ORDERING INFORMATION TABLE**

|             |            |           |           |          |          |           |          |          |
|-------------|------------|-----------|-----------|----------|----------|-----------|----------|----------|
| Device code | <b>VS-</b> | <b>SD</b> | <b>60</b> | <b>0</b> | <b>N</b> | <b>32</b> | <b>P</b> | <b>C</b> |
|             | ①          | ②         | ③         | ④        | ⑤        | ⑥         | ⑦        | ⑧        |

- 1** - Vishay Semiconductors product
- 2** - Diode
- 3** - Essential part number
- 4** - 0 = Standard recovery
- 5** - • N = Stud normal polarity (cathode to stud)  
• R = Stud reverse polarity (anode to stud)
- 6** - Voltage code x 100 =  $V_{RRM}$  (see Voltage Ratings table)
- 7** - P = Stud base B-8 3/4" 16UNF-2A
- 8** - C = Ceramic cap

For metric device M24 x 1.5 contact factory

| LINKS TO RELATED DOCUMENTS |  |
|----------------------------|--|
| Dimensions                 | <a href="http://www.vishay.com/doc?95303">www.vishay.com/doc?95303</a> |

## B-8

**DIMENSIONS** in millimeters (inches)

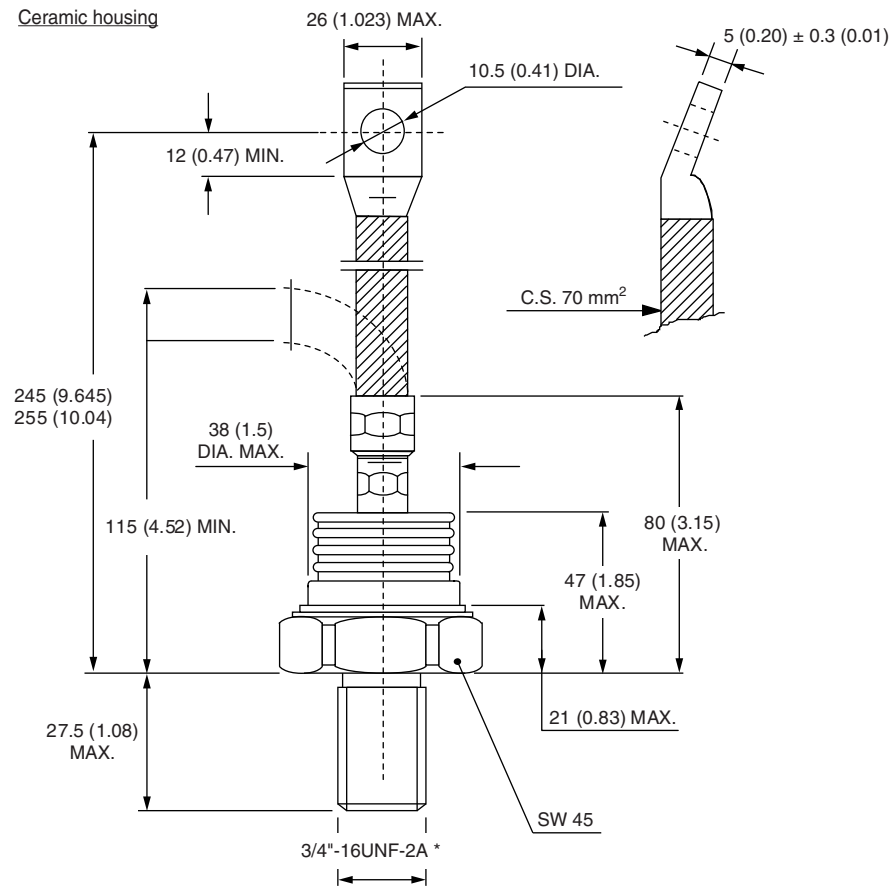

\*For metric device: M24 x 1.5 - length 21 (0.83) MAX.  
contact factory



## Disclaimer

ALL PRODUCT, PRODUCT SPECIFICATIONS AND DATA ARE SUBJECT TO CHANGE WITHOUT NOTICE TO IMPROVE RELIABILITY, FUNCTION OR DESIGN OR OTHERWISE.

Vishay Intertechnology, Inc., its affiliates, agents, and employees, and all persons acting on its or their behalf (collectively, "Vishay"), disclaim any and all liability for any errors, inaccuracies or incompleteness contained in any datasheet or in any other disclosure relating to any product.

Vishay makes no warranty, representation or guarantee regarding the suitability of the products for any particular purpose or the continuing production of any product. To the maximum extent permitted by applicable law, Vishay disclaims (i) any and all liability arising out of the application or use of any product, (ii) any and all liability, including without limitation special, consequential or incidental damages, and (iii) any and all implied warranties, including warranties of fitness for particular purpose, non-infringement and merchantability.

Statements regarding the suitability of products for certain types of applications are based on Vishay's knowledge of typical requirements that are often placed on Vishay products in generic applications. Such statements are not binding statements about the suitability of products for a particular application. It is the customer's responsibility to validate that a particular product with the properties described in the product specification is suitable for use in a particular application. Parameters provided in datasheets and/or specifications may vary in different applications and performance may vary over time. All operating parameters, including typical parameters, must be validated for each customer application by the customer's technical experts. Product specifications do not expand or otherwise modify Vishay's terms and conditions of purchase, including but not limited to the warranty expressed therein.

Except as expressly indicated in writing, Vishay products are not designed for use in medical, life-saving, or life-sustaining applications or for any other application in which the failure of the Vishay product could result in personal injury or death. Customers using or selling Vishay products not expressly indicated for use in such applications do so at their own risk. Please contact authorized Vishay personnel to obtain written terms and conditions regarding products designed for such applications.

No license, express or implied, by estoppel or otherwise, to any intellectual property rights is granted by this document or by any conduct of Vishay. Product names and markings noted herein may be trademarks of their respective owners.

## Material Category Policy

**Vishay Intertechnology, Inc. hereby certifies that all its products that are identified as RoHS-Compliant fulfill the definitions and restrictions defined under Directive 2011/65/EU of The European Parliament and of the Council of June 8, 2011 on the restriction of the use of certain hazardous substances in electrical and electronic equipment (EEE) - recast, unless otherwise specified as non-compliant.**

**Please note that some Vishay documentation may still make reference to RoHS Directive 2002/95/EC. We confirm that all the products identified as being compliant to Directive 2002/95/EC conform to Directive 2011/65/EU.**

**Vishay Intertechnology, Inc. hereby certifies that all its products that are identified as Halogen-Free follow Halogen-Free requirements as per JEDEC JS709A standards. Please note that some Vishay documentation may still make reference to the IEC 61249-2-21 definition. We confirm that all the products identified as being compliant to IEC 61249-2-21 conform to JEDEC JS709A standards.**



## Данный компонент на территории Российской Федерации

### Вы можете приобрести в компании MosChip.

Для оперативного оформления запроса Вам необходимо перейти по данной ссылке:

<http://moschip.ru/get-element>

Вы можете разместить у нас заказ для любого Вашего проекта, будь то серийное производство или разработка единичного прибора.

В нашем ассортименте представлены ведущие мировые производители активных и пассивных электронных компонентов.

Нашей специализацией является поставка электронной компонентной базы двойного назначения, продукции таких производителей как XILINX, Intel (ex.ALTERA), Vicor, Microchip, Texas Instruments, Analog Devices, Mini-Circuits, Amphenol, Glenair.

Сотрудничество с глобальными дистрибьюторами электронных компонентов, предоставляет возможность заказывать и получать с международных складов практически любой перечень компонентов в оптимальные для Вас сроки.

На всех этапах разработки и производства наши партнеры могут получить квалифицированную поддержку опытных инженеров.

Система менеджмента качества компании отвечает требованиям в соответствии с ГОСТ Р ИСО 9001, ГОСТ РВ 0015-002 и ЭС РД 009

### Офис по работе с юридическими лицами:

105318, г.Москва, ул.Щербаковская д.3, офис 1107, 1118, ДЦ «Щербаковский»

Телефон: +7 495 668-12-70 (многоканальный)

Факс: +7 495 668-12-70 (доб.304)

E-mail: [info@moschip.ru](mailto:info@moschip.ru)

Skype отдела продаж:

moschip.ru

moschip.ru\_4

moschip.ru\_6

moschip.ru\_9