



General Description

The AZV358 is dual low voltage (2.7-5.5V) operational amplifiers which have rail-to-rail output swing capability. The input common-mode voltage range includes ground. The chip exhibits excellent speed-power ratio, achieving 1MHz of bandwidth and 1V/ μ s of slew rate with low supply current.

The AZV358 is built with BiCMOS process. It has bipolar input and output stages for improved noise performance, low input offset voltage and higher output current drive.

AZV358 is available in the package of TSSOP-8 and MSOP-8. The small packages save space on pc boards, and enable the design of small portable electronic devices. It also allows the designer to place the device closer to the signal source to reduce noise pickup and increase signal integrity.

AZV358 is also available in standard SOIC-8 package.

Features

(For $V_{CC}=5V$ and $V_{EE}=0V$, typical unless otherwise noted)

- Guaranteed 2.7V to 5.5V Performance
- No Crossover Distortion
- Gain-Bandwidth Product 1MHz
- Industrial Temperature Range: $-40^{\circ}C$ to $+85^{\circ}C$
- Low Supply Current: 210 μ A
- Rail-to-Rail Output Swing under 10k Ω Load:
 - V_{OH} up to $V_{CC} - 10mV$
 - V_{OL} near to $V_{EE} + 65mV$
- V_{CM} : $-0.1V$ to $V_{CC} - 0.8V$

Applications

- Active Filters
- Low Power, Low Voltage Applications
- General Purpose Portable Devices
- Cellular Phone, Cordless Phone
- Battery-Powered Systems



Figure 1. Package Types of AZV358

Pin Configuration

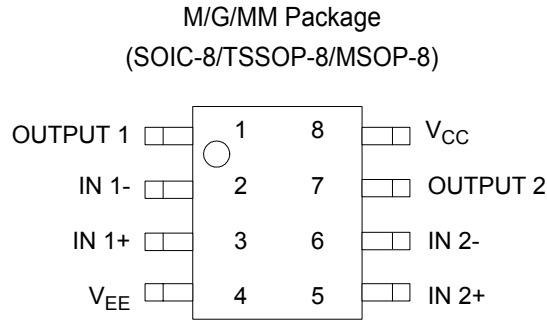

Figure 2. Pin Configuration of AZV358 (Top View)

Functional Block Diagram

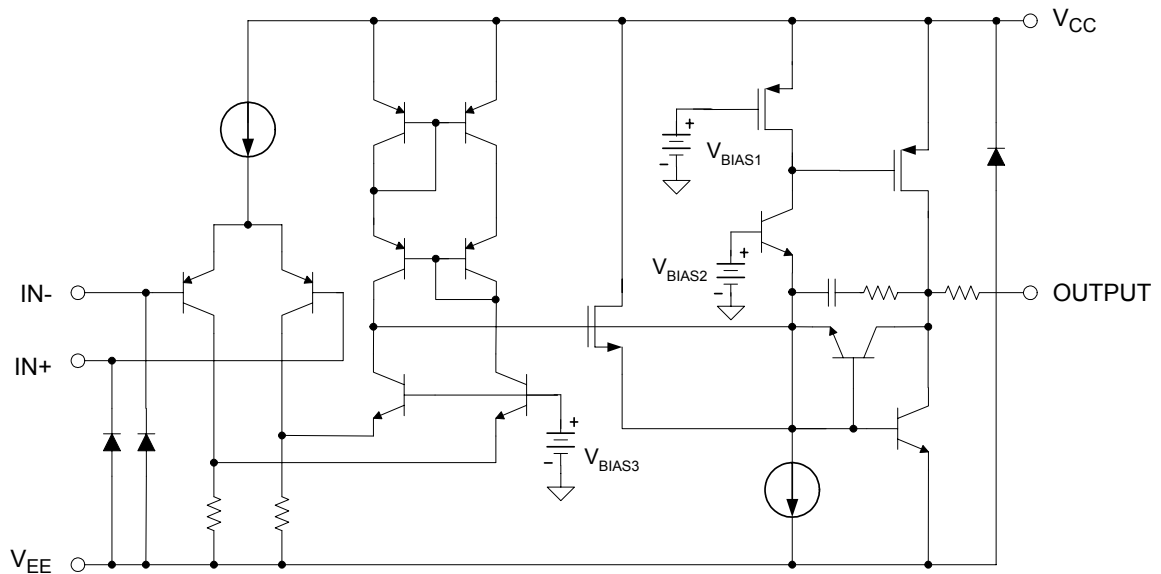
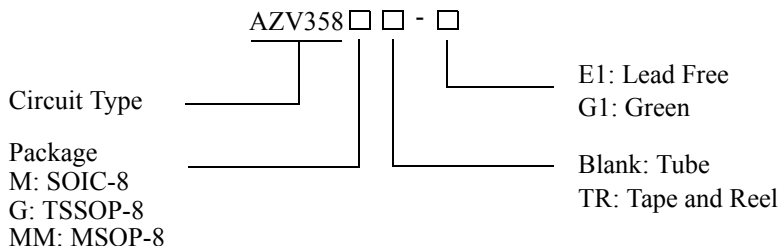

Figure 3. Functional Block Diagram of AZV358 (Each Block)



DUAL LOW VOLTAGE RAIL-TO-RAIL OUTPUT OPERATIONAL AMPLIFIERS AZV358

Ordering Information



Package	Temperature Range	Part Number		Marking ID		Packing Type
		Lead Free	Green	Lead Free	Green	
SOIC-8	-40 to 85°C	AZV358M-E1	AZV358M-G1	AZV358M-E1	AZV358M-G1	Tube
		AZV358MTR-E1	AZV358MTR-G1	AZV358M-E1	AZV358M-G1	Tape & Reel
TSSOP-8	-40 to 85°C	AZV358G-E1	AZV358G-G1	EG3E	GG3E	Tube
		AZV358GTR-E1	AZV358GTR-G1	EG3E	GG3E	Tape & Reel
MSOP-8	-40 to 85°C	AZV358MM-E1	AZV358MM-G1	AZV358MM-E1	AZV358MM-G1	Tube
		AZV358MMTR-E1	AZV358MMTR-G1	AZV358MM-E1	AZV358MM-G1	Tape & Reel

BCD Semiconductor's Pb-free products, as designated with "E1" suffix in the part number, are RoHS compliant. Products with "G1" suffix are available in green packages.

Absolute Maximum Ratings (Note 1)

Parameter	Symbol	Value	Unit
Power Supply Voltage	V _{CC}	6	V
Operation Junction Temperature	T _J	150	°C
Storage Temperature Range	T _{STG}	-65 to 150	°C
Lead Temperature (Soldering, 10 Seconds)	T _{LEAD}	260	°C
ESD (Machine Model)		200	V
ESD (Human Body Model)		2000	V

Note 1: Stresses greater than those listed under "Absolute Maximum Ratings" may cause permanent damage to the device. These are stress ratings only, and functional operation of the device at these or any other conditions beyond those indicated under "Recommended Operating Conditions" is not implied. Exposure to "Absolute Maximum Ratings" for extended periods may affect device reliability.

Recommended Operating Conditions

Parameter	Symbol	Min	Max	Unit
Supply Voltage	V _{CC}	2.7	5.5	V
Ambient Operating Temperature Range	T _A	-40	85	°C



DUAL LOW VOLTAGE RAIL-TO-RAIL OUTPUT OPERATIONAL AMPLIFIERS AZV358

2.7V Electrical Characteristics

Limits in standard typeface are for $T_A=25^{\circ}\text{C}$, **bold** typeface applies over $T_A=-40^{\circ}\text{C}$ to 85°C , $V_{CC}=2.7\text{V}$, $V_{EE}=0\text{V}$, $V_{CM}=1.0\text{V}$, $V_O=V_{CC}/2$ and $R_L>1\text{M}\Omega$, unless otherwise specified. (Note 2)

Parameter	Symbol	Conditions	Min	Typ	Max	Unit
Input Offset Voltage	V_{IO}			1.7	7	mV
					9	
Input Bias Current	I_B			11	250	nA
					500	
Input Offset Current	I_{IO}			5	50	nA
					150	
Input Common Mode Voltage Range	V_{CM}	for $\text{CMRR}\geq 50\text{dB}$	-0.1		1.9	V
Supply Current	I_{CC}	$V_O=V_{CC}/2$, $A_{VCL}=1$, No load		140	340	μA
					420	
Common Mode Rejection Ratio	CMRR	$0\leq V_{CM}\leq 1.7\text{V}$	50	63		dB
Power Supply Rejection Ratio	PSRR	$2.7\text{V}\leq V_{CC}\leq 5\text{V}$, $V_O=1\text{V}$,	50	60		dB
Output Short Circuit Current	I_{SOURCE}	$V_O=0\text{V}$	5	20		mA
	I_{SINK}	$V_O=2.7\text{V}$	10	30		mA
Output Voltage Swing	V_{OH}	$R_L=10\text{k}\Omega$ to 1.35V	2.60	2.69		V
	V_{OL}			60	180	mV
Gain Bandwidth Product	GBWP	$C_L=200\text{pF}$		1		MHz
Phase Margin	ϕ_M			60		deg
Gain Margin	G_M			10		dB

Note 2: Limits over the full temperature are guaranteed by design, but not tested in production.



DUAL LOW VOLTAGE RAIL-TO-RAIL OUTPUT OPERATIONAL AMPLIFIERS AZV358

5V Electrical Characteristics

Limits in standard typeface are for $T_A=25^{\circ}\text{C}$, **bold** typeface applies over $T_A=-40^{\circ}\text{C}$ to 85°C , $V_{CC}=5\text{V}$, $V_{EE}=0\text{V}$, $V_{CM}=2.0\text{V}$, $V_O=V_{CC}/2$ and $R_L>1\text{M}\Omega$, unless otherwise specified. (Note 2)

Parameter	Symbol	Conditions	Min	Typ	Max	Unit
Input Offset Voltage	V_{IO}			1.7	7	mV
					9	
Input Bias Current	I_B			15	250	nA
					500	
Input Offset Current	I_{IO}			5	50	nA
					150	
Input Common Mode Voltage Range	V_{CM}	for $\text{CMRR}\geq 50\text{dB}$	-0.1		4.2	V
Supply Current	I_{CC}	$V_O=V_{CC}/2$, $A_{VCL}=1$, No load		210	440	μA
					615	
Large Signal Voltage Gain	G_V	$R_L=2\text{k}\Omega$	84	100		dB
			80			
Common Mode Rejection Ratio	CMRR	$0\leq V_{CM}\leq 4\text{V}$	50	63		dB
Power Supply Rejection Ratio	PSRR	$2.7\text{V}\leq V_{CC}\leq 5\text{V}$ $V_O=1\text{V}$, $V_{CM}=1\text{V}$	50	60		dB
Output Short Circuit Current	I_{SOURCE}	$V_O=0\text{V}$	5	60		mA
	I_{SINK}	$V_O=5\text{V}$	10	160		mA
Output Voltage Swing	V_{OH}	$R_L=2\text{k}\Omega$ to 2.5V	4.7	4.96		V
			4.6			
		$R_L=10\text{k}\Omega$ to 2.5V	4.9	4.99		
			4.8			
	V_{OL}	$R_L=2\text{k}\Omega$ to 2.5V		120	300	mV
					400	
$R_L=10\text{k}\Omega$ to 2.5V			65	180		
				280		
Slew Rate	SR		1		V/ μs	
Gain Bandwidth Product	GBWP	$C_L=200\text{pF}$		1		MHz
Phase Margin	ϕ_M			60		deg
Gain Margin	G_M			10		dB

Note 2: Limits over the full temperature are guaranteed by design, but not tested in production.



Typical Performance Characteristics

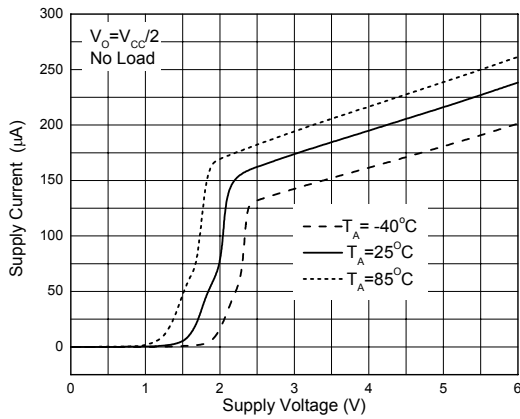

Figure 4. Supply Current vs. Supply Voltage

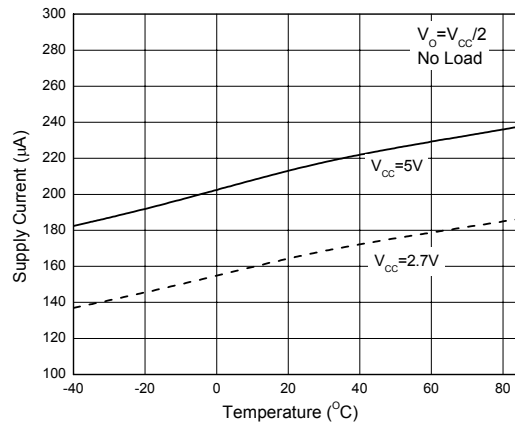

Figure 5. Supply Current vs. Temperature

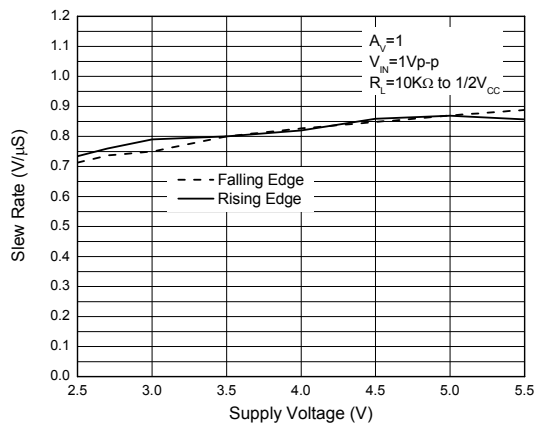

Figure 6. Slew Rate vs. Supply Voltage

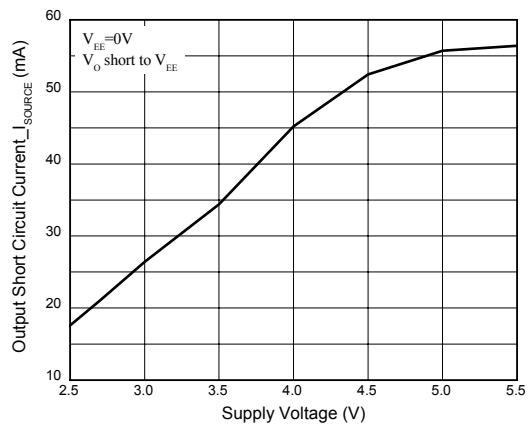

Figure 7. Output Short Circuit Current vs. Supply Voltage



DUAL LOW VOLTAGE RAIL-TO-RAIL OUTPUT OPERATIONAL AMPLIFIERS **AZV358**

Typical Performance Characteristics (Continued)

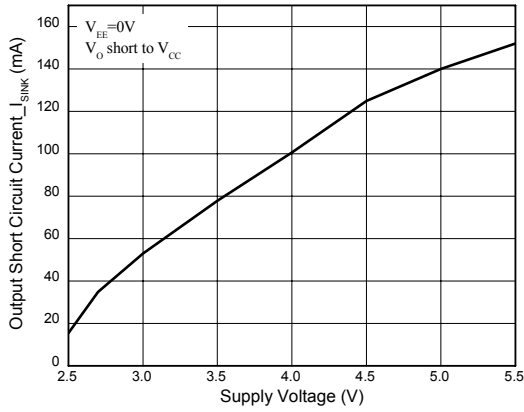

Figure 8. Output Short Circuit Current vs. Supply Voltage

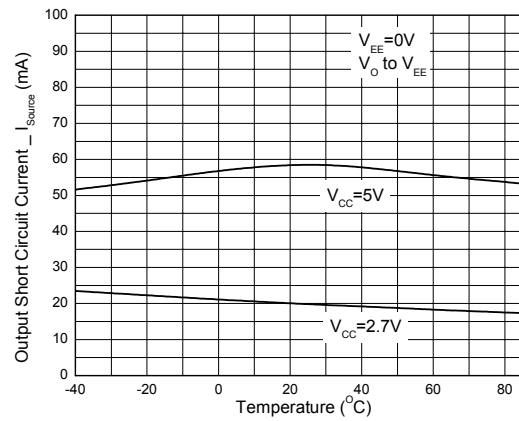

Figure 9. Output Short Circuit Current vs. Temperature

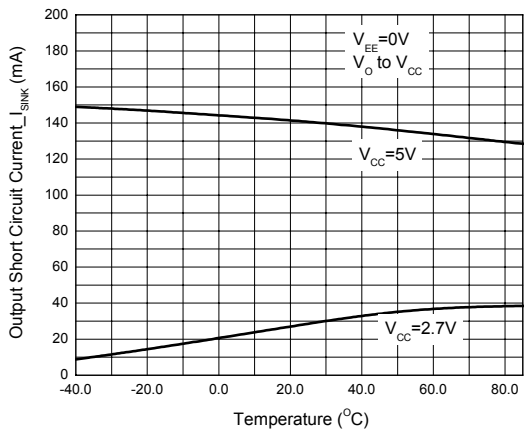

Figure 10. Output Short Circuit Current vs. Temperature

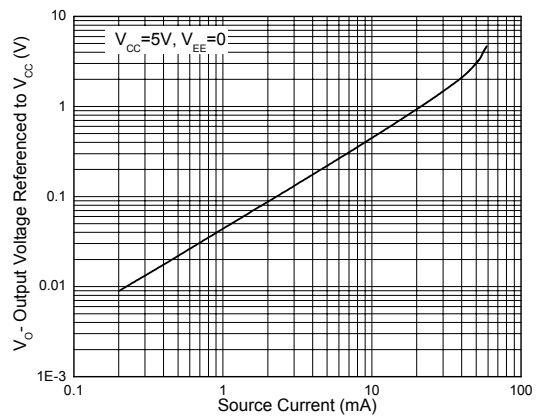

Figure 11. Output Voltage vs. Output Source Current



Typical Performance Characteristics (Continued)

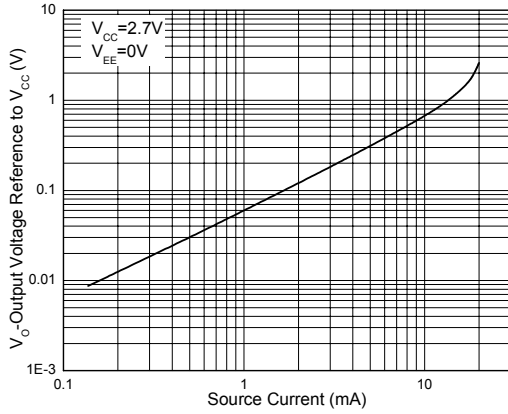

Figure 12. Output Voltage vs. Output Source Current

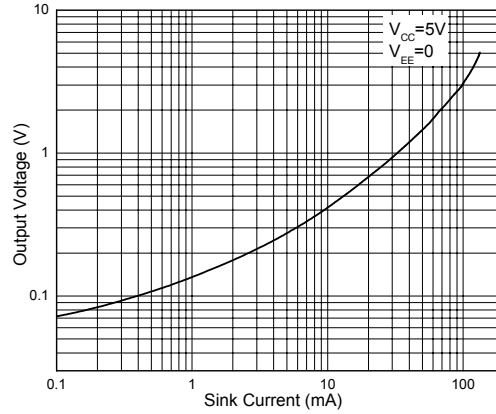

Figure 13. Output Voltage vs. Output Sink Current

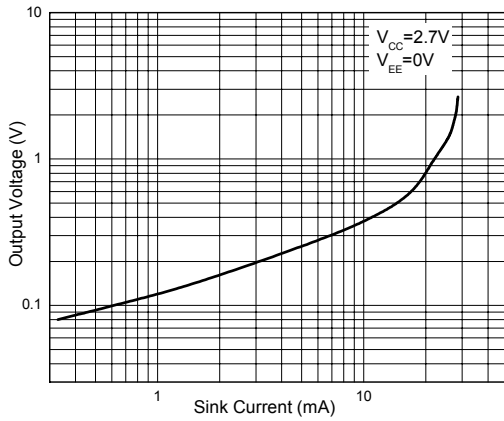

Figure 14. Output Voltage vs. Output Sink Current

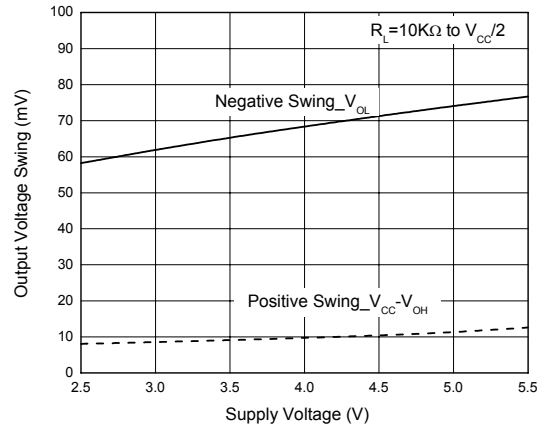

Figure 15. Output Voltage Swing vs. Supply Voltage



Typical Performance Characteristics (Continued)

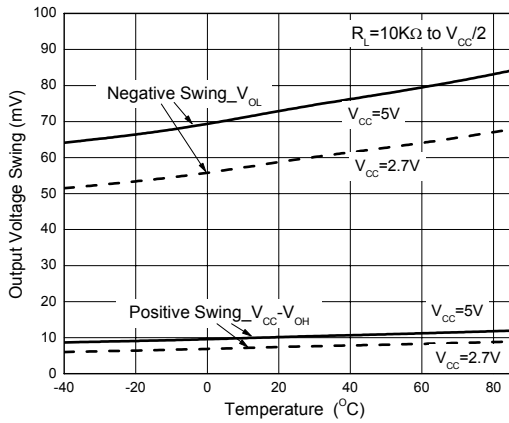

Figure 16. Output Voltage Swing vs. Temperature

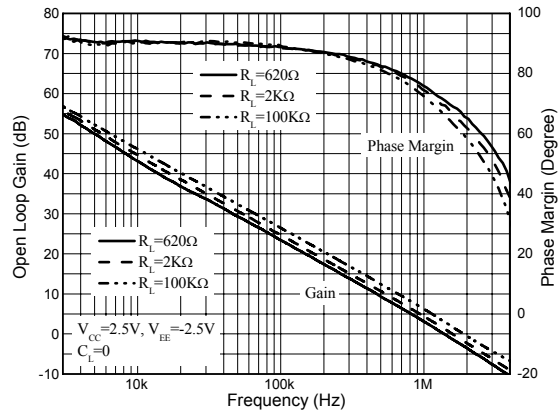

Figure 17. Gain and Phase vs. Frequency and Resistive Load

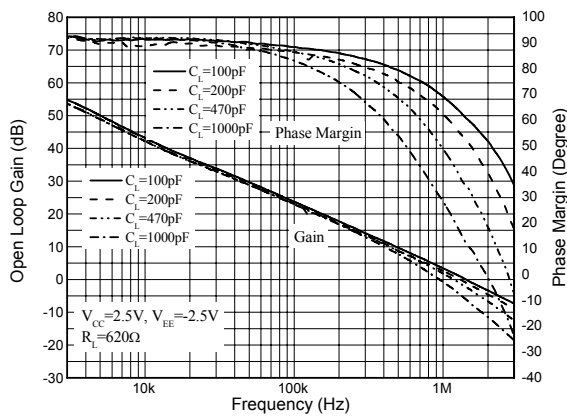

Figure 18. Gain and Phase vs. Frequency and Capacitive Load

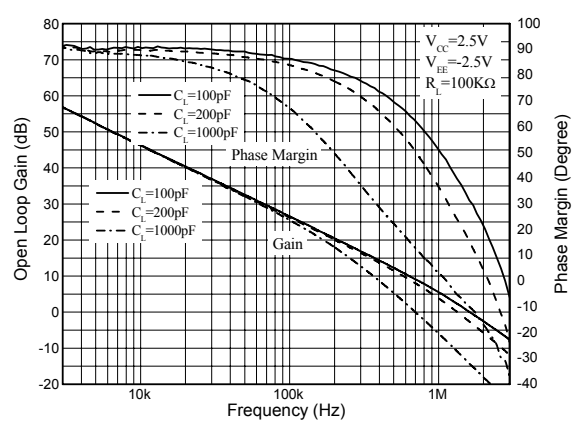

Figure 19. Gain and Phase vs. Frequency and Capacitive Load

Typical Performance Characteristics (Continued)

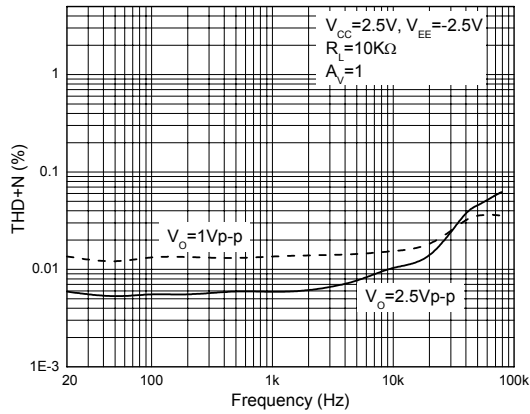

Figure 20. THD+N vs. Frequency

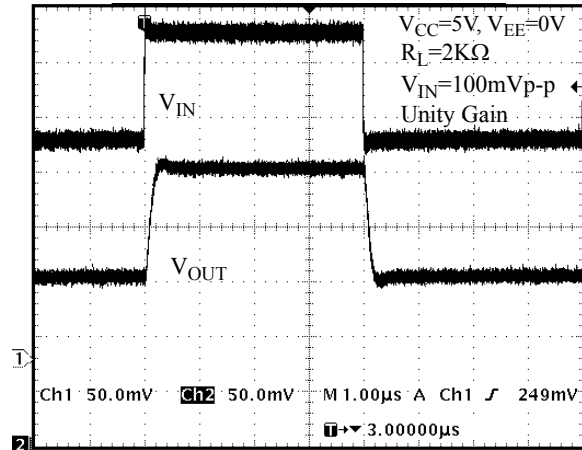

Figure 21. Non-Inverting Input Small Signal Pulse Response

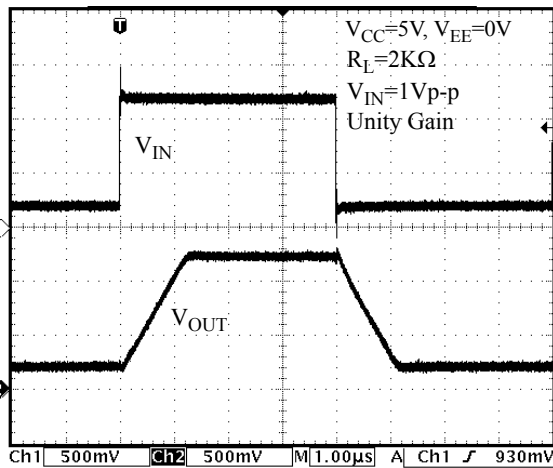

Figure 22. Non-Inverting Input Large Signal Pulse Response

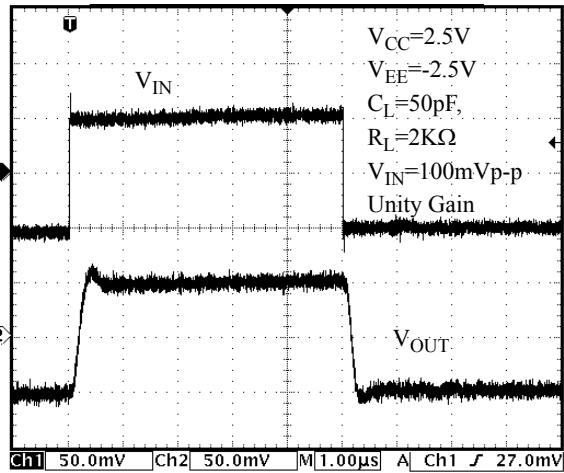

Figure 23. Non-Inverting Input Small Signal Response

Typical Performance Characteristics (Continued)

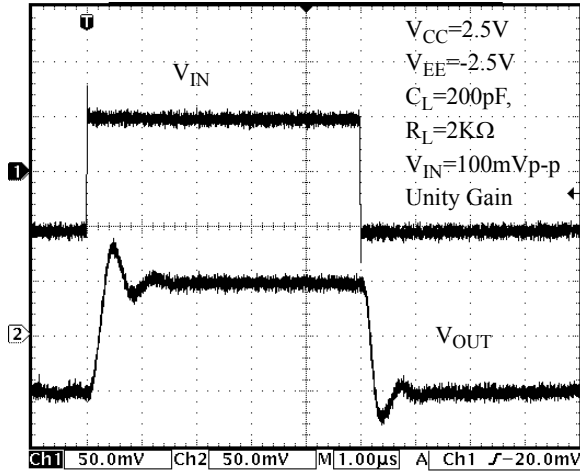

Figure 24. Non-Inverting Input Small Signal Response



Mechanical Dimensions

SOIC-8

Unit: mm(inch)

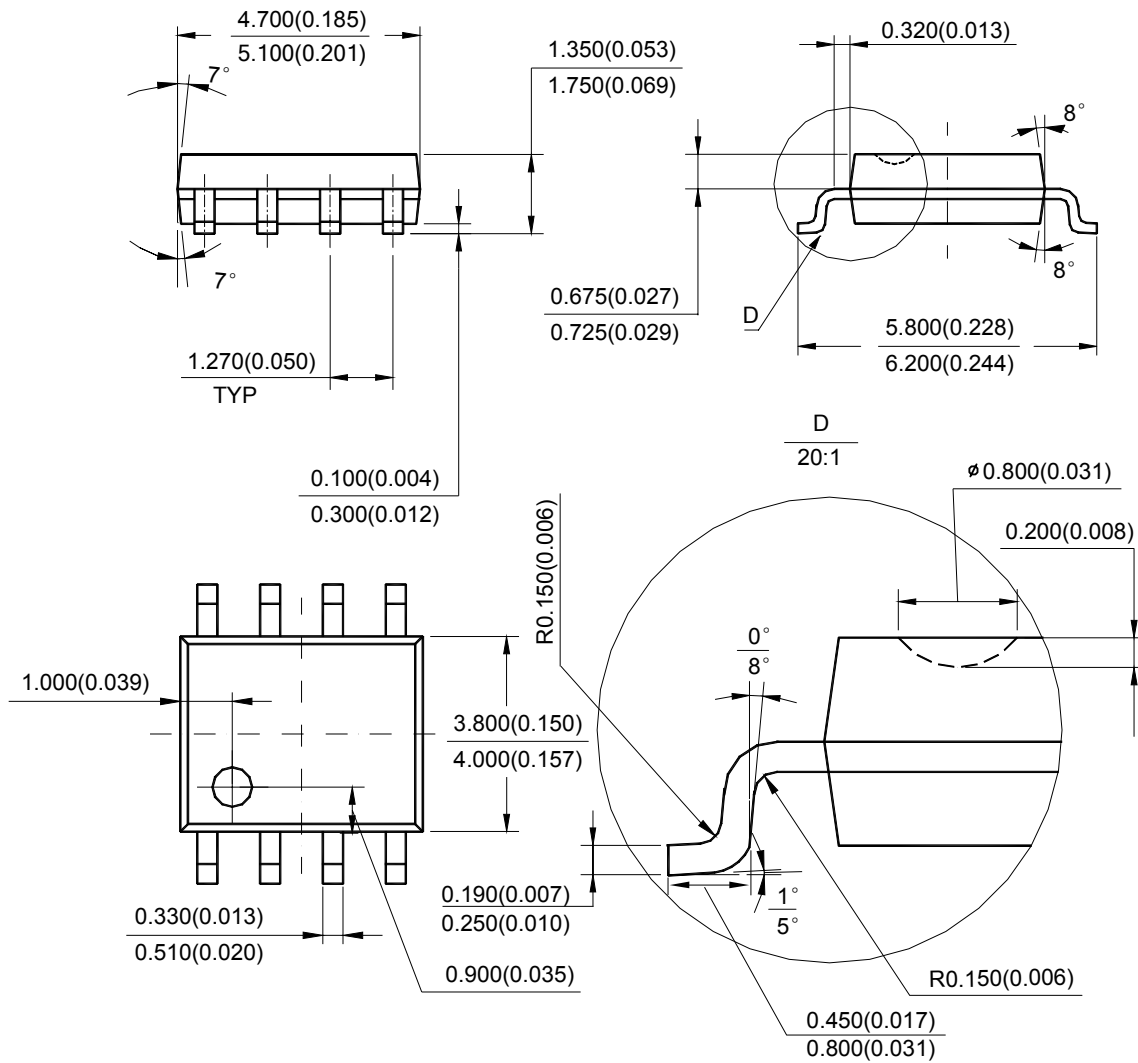

Note: Eject hole, oriented hole and mold mark is optional.



Mechanical Dimensions (Continued)

TSSOP-8

Unit: mm(inch)

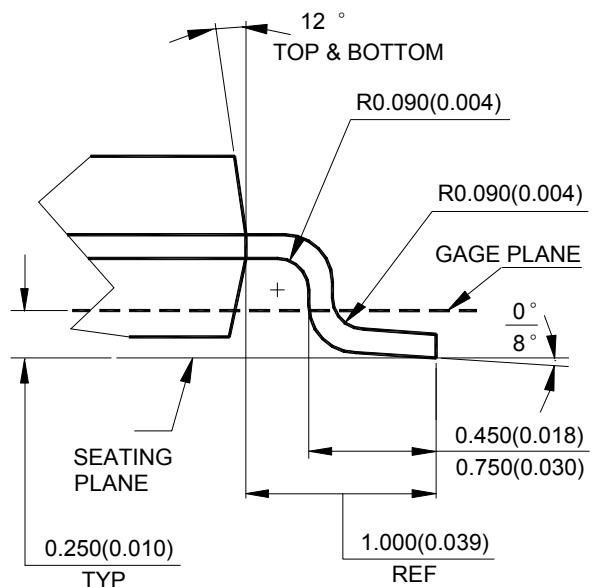
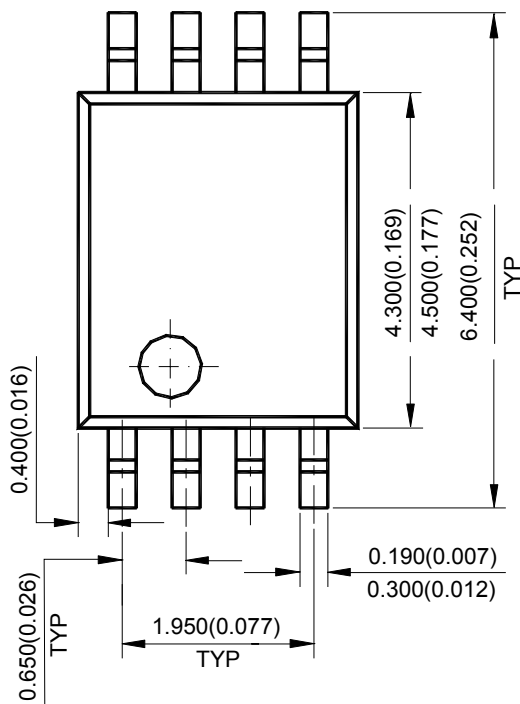
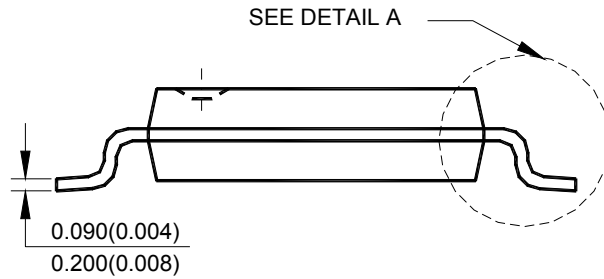
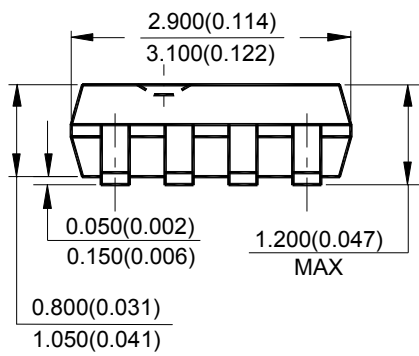

DETAIL A

Note: Eject hole, oriented hole and mold mark is optional.



Mechanical Dimensions (Continued)

MSOP-8

Unit: mm(inch)

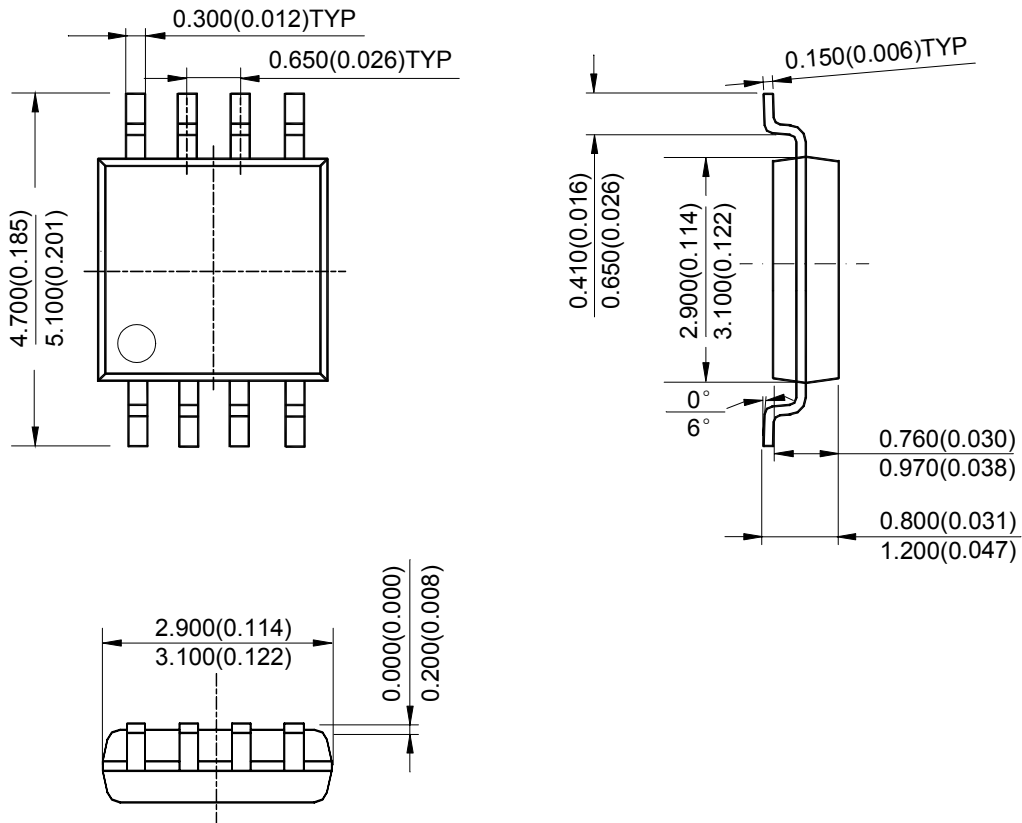

Note: Eject hole, oriented hole and mold mark is optional.



BCD Semiconductor Manufacturing Limited

<http://www.bcdsemi.com>

IMPORTANT NOTICE

BCD Semiconductor Manufacturing Limited reserves the right to make changes without further notice to any products or specifications herein. BCD Semiconductor Manufacturing Limited does not assume any responsibility for use of any its products for any particular purpose, nor does BCD Semiconductor Manufacturing Limited assume any liability arising out of the application or use of any its products or circuits. BCD Semiconductor Manufacturing Limited does not convey any license under its patent rights or other rights nor the rights of others.

MAIN SITE

- Headquarters

BCD Semiconductor Manufacturing Limited

No. 1600, Zi Xing Road, Shanghai Zizhu Science-based Industrial Park, 200241, China
Tel: +86-21-24162266, Fax: +86-21-24162277

- Wafer Fab

Shanghai SIM-BCD Semiconductor Manufacturing Co., Ltd.

800 Yi Shan Road, Shanghai 200233, China
Tel: +86-21-6485 1491, Fax: +86-21-5450 0008

REGIONAL SALES OFFICE

Shenzhen Office

Shanghai SIM-BCD Semiconductor Manufacturing Co., Ltd., Shenzhen Office

Unit A Room 1203, Skyworth Bldg., Gaoxin Ave. 1.S., Nanshan District, Shenzhen, China
Tel: +86-755-8826 7951
Fax: +86-755-8826 7865

Taiwan Office

BCD Semiconductor (Taiwan) Company Limited

4F, 298-1, Rui Guang Road, Nei-Hu District, Taipei, Taiwan
Tel: +886-2-2656 2808
Fax: +886-2-2656 2806

USA Office

BCD Semiconductor Corp.

30920 Huntwood Ave. Hayward, CA 94544, USA
Tel : +1-510-324-2988
Fax: +1-510-324-2788

Данный компонент на территории Российской Федерации

Вы можете приобрести в компании MosChip.

Для оперативного оформления запроса Вам необходимо перейти по данной ссылке:

<http://moschip.ru/get-element>

Вы можете разместить у нас заказ для любого Вашего проекта, будь то серийное производство или разработка единичного прибора.

В нашем ассортименте представлены ведущие мировые производители активных и пассивных электронных компонентов.

Нашей специализацией является поставка электронной компонентной базы двойного назначения, продукции таких производителей как XILINX, Intel (ex.ALTERA), Vicor, Microchip, Texas Instruments, Analog Devices, Mini-Circuits, Amphenol, Glenair.

Сотрудничество с глобальными дистрибьюторами электронных компонентов, предоставляет возможность заказывать и получать с международных складов практически любой перечень компонентов в оптимальные для Вас сроки.

На всех этапах разработки и производства наши партнеры могут получить квалифицированную поддержку опытных инженеров.

Система менеджмента качества компании отвечает требованиям в соответствии с ГОСТ Р ИСО 9001, ГОСТ РВ 0015-002 и ЭС РД 009

Офис по работе с юридическими лицами:

105318, г.Москва, ул.Щербаковская д.3, офис 1107, 1118, ДЦ «Щербаковский»

Телефон: +7 495 668-12-70 (многоканальный)

Факс: +7 495 668-12-70 (доб.304)

E-mail: info@moschip.ru

Skype отдела продаж:

moschip.ru

moschip.ru_4

moschip.ru_6

moschip.ru_9