



Designers' Choice

GROMMETS, BUMPERS & BUSHINGS

RUBBER GROMMETS

Ideal for electrical insulation and mechanical damping. Made from BUNA S.

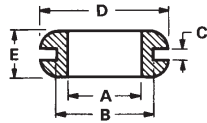

CAT. NO.	I.D. A	For Hole B	For Panel C	D	E
730	.125	.187	.062	.312	.187
733	.125	.250	.062	.343	.187
734	.125	.437	.062	.625	.187
735	.125	.375	.093	.500	.312
736	.187	.312	.062	.437	.218
731	.187	.312	.062	.437	.218
737	.187	.281	.093	.437	.218
738	.250	.437	.062	.625	.187
739	.250	.375	.062	.562	.250
740	.250	.375	.093	.500	.250
741	.312	.562	.062	.812	.312
742	.312	.437	.062	.625	.281
743	.312	.437	.093	.625	.312
744	.375	.625	.062	.875	.312
745	.375	.500	.062	.625	.250
732	.437	.562	.062	.750	.250
746	.437	.687	.062	.937	.312
747	.500	.812	.062	1.062	.312
748	.500	1.250	.062	1.500	.250
749	.500	.750	.093	.968	.281
750	.562	.812	.062	1.062	.312
752	.625	.875	.062	1.125	.312
753	.625	1.250	.062	1.500	.250
755	.750	1.062	.062	1.375	.375
756	.750	1.437	.062	1.812	.375
757	.875	1.250	.062	1.625	.437

RECESSED BUMPERS

Provides excellent traction and shock absorbing qualities. available with or without Mold-in Washers.

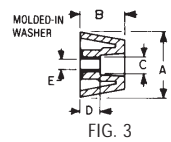
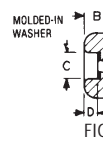
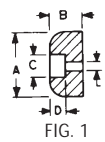

MATERIAL: Rubber, BUNA S (figs. 1 & 2), Vinyl (fig. 3)

CAT. NO.	FIG.	A	B	C	D	E	Screw Size
720	1	.500	.250	.250	.187	.125	#4
721	1	.625	.312	.250	.187	.125	#4
722	1	.718	.437	.250	.218	.125	#4
723	2	.937	.375	.375	.187	.187	#8
*724	3	.687	.250	.343	.125	.155	#6
*725	3	.875	.312	.406	.125	.187	#8
*726	3	1.062	.437	.468	.234	.200	#10
727	3	.562	.375	.218	.187	.115	#4
728	3	.750	.437	.265	.250	.148	#6
729	3	.937	.625	.359	.297	.174	#8

*Grey - all others black

SELF-LOCKING BUMPER FOOT

- A unique easy-to-install self-locking bumper foot
- Two piece assembly, furnished pre-assembled
- Vibration absorbing and skid resistant
- Mounts without screws or tools

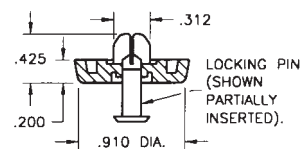

MATERIAL:
Foot: Santoprene, Black
Pin: Polypropylene, Black

CAT. NO. 717

Recommended Mounting Hole: .305 dia.

"UNIVERSAL" RUBBER GROMMET

Designed to adjust to different wire, cable or tubing diameters from .125 to .312

- Self-adjusting membrane forms a dust resistant seal
- Installs in .500 diameter hole in .062 thick panels or boards
- Molded outer ring retains grommet in place

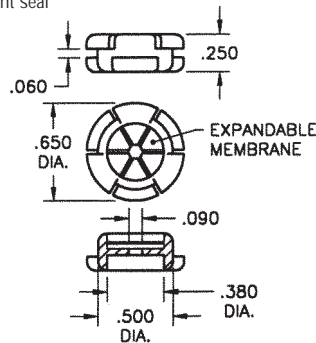

MATERIAL: Black Thermoplastic Rubber

CAT. NO. 777

NYLON SPLIT BUSHINGS

Designed to be assembled into holes that already contain wire or cable. Versatile bushing can be used on all chassis from .032 to .125 thick.

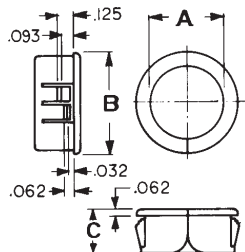

CAT. NO.	HOLE SIZE REQUIRED	A INSIDE DIA.	B HEAD DIA.
8490	.375	.265	.421
8491	.500	.312	.562
8492	.562	.390	.640
8493	.625	.453	.687
8494	.750	.546	.796
8495	.875	.671	.921
8496	1.000	.796	1.062

MATERIAL: Nylon 6/6, Black

NYLON INSULATED BUSHINGS

Snaps into panel hole to provide protection for wire, cable and tubing from sharp uneven edges.

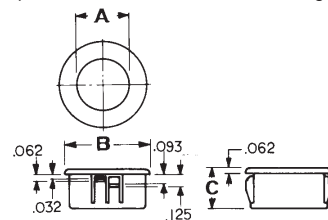

MATERIAL: Nylon 6/6, Black

CAT. NO.	HOLE SIZE REQUIRED	MAXIMUM CHASSIS THICKNESS	A INSIDE DIA.	B HEAD DIA.	C OVERALL HEIGHT
8470	.250	.062	.125	.312	.312
8471	.312	.062	.187	.375	.312
8472	.375	.125	.250	.468	.406
8473	.437	.125	.312	.531	.406
8474	.500	.125	.375	.578	.406
8475	.562	.125	.437	.656	.406
8476	.625	.125	.500	.718	.406
8477	.750	.125	.562	.843	.406
8478	.875	.125	.625	.953	.453
8479	1.000	.125	.750	1.125	.453
8480	1.187	.125	.937	1.312	.453
8481	1.250	.125	.937	1.359	.453
8482	1.375	.125	1.000	1.468	.453
8483	1.500	.125	1.062	1.609	.453
8484	1.750	.125	1.375	1.875	.453
8485	2.000	.125	1.625	2.125	.453
8486	2.500	.250	1.968	2.656	.718

Данный компонент на территории Российской Федерации

Вы можете приобрести в компании MosChip.

Для оперативного оформления запроса Вам необходимо перейти по данной ссылке:

<http://moschip.ru/get-element>

Вы можете разместить у нас заказ для любого Вашего проекта, будь то серийное производство или разработка единичного прибора.

В нашем ассортименте представлены ведущие мировые производители активных и пассивных электронных компонентов.

Нашей специализацией является поставка электронной компонентной базы двойного назначения, продукции таких производителей как XILINX, Intel (ex.ALTERA), Vicor, Microchip, Texas Instruments, Analog Devices, Mini-Circuits, Amphenol, Glenair.

Сотрудничество с глобальными дистрибьюторами электронных компонентов, предоставляет возможность заказывать и получать с международных складов практически любой перечень компонентов в оптимальные для Вас сроки.

На всех этапах разработки и производства наши партнеры могут получить квалифицированную поддержку опытных инженеров.

Система менеджмента качества компании отвечает требованиям в соответствии с ГОСТ Р ИСО 9001, ГОСТ РВ 0015-002 и ЭС РД 009

Офис по работе с юридическими лицами:

105318, г.Москва, ул.Щербаковская д.3, офис 1107, 1118, ДЦ «Щербаковский»

Телефон: +7 495 668-12-70 (многоканальный)

Факс: +7 495 668-12-70 (доб.304)

E-mail: info@moschip.ru

Skype отдела продаж:

moschip.ru

moschip.ru_4

moschip.ru_6

moschip.ru_9