

## TEC Series

Wakefield-Vette's **Peltier, thermoelectric coolers** can meet the requirement of higher current and large cooling. It is often applied to experimental, scientific and biomedical instruments, laboratory equipment, industry and electrical equipment and consumables. The ambient temperature can arrive 100C, long-term working temperature is recommended to be below 90C.



### Features:

- All products are RoHS and REACH compliant, SGS ISO9001 verified
- Thermoelectric module material are UL certification
- Standard Wire is 150mm
- Thermoelectric module moisture protection standard is sealed by white RTV silicone, but also support select other moisture protection style, Such as translucent silicone, black epoxy.
- Thermoelectric module flatness tolerance support select 0.2mm, 0.13mm, 0.1mm.

WKV Part Number	Description	Current max (A)	Q max (W) @ 27°C	V max (V) @ 27°C	ΔT max (°C) @ 27°C	# of Couples	Outline (L/W/)	Height (mm)
TEC-30-40-127	PELTIER TEC 30X30 4MM 2.5A	2.5	21.4	15.4	68	127	30x30	4
TEC-30-32-127	PELTIER TEC 30X30 3.2MM 3.9A	3.9	33.4	15.4	68	127	30x30	3.2
TEC-40-47-127	PELTIER TEC 40X40 4.7MM 3.9A	3.9	33.4	15.4	69	127	40x40	4.7
TEC-40-33-127	PELTIER TEC 40X40 3.3MM 8.5A	8.5	72	15.4	69	127	40x40	3.3
TEC-30-36-127	PELTIER TEC 30X30 3.6MM 3.0A	3.0	25.7	15.4	68	127	30x30	3.6
TEC-30-47-71	PELTIER TEC 30X30 4.7MM 3.9A	3.9	18.7	8.6	69	71	30x30	4.7
TEC-30-38-71	PELTIER TEC 30X30 3.8MM 6.0A	6.0	28.7	8.6	69	71	30x30	3.8
TEC-40-38-127	PELTIER TEC 40X40 3.8MM 6.0A	6.0	51.4	15.4	69	127	40x40	3.8
TEC-20-33-31	PELTIER TEC 20X20 3.3MM 8.5A	8.5	16.8	3.75	69	31	20x20	3.3
TEC-30-33-71	PELTIER TEC 30X30 3.3MM 8.5A	8.5	72	15.4	69	71	30x30	3.3

# Thermoelectric Cooler Performance Specifications



## TEC-40-47-127

Hot Side Temperature(°C)	25 °C	50 °C
Qmax (Watts)	33.4	39
Delta Tmax(°C)	67	75
Imax (Amps)	4	4
Vmax (Volts)	15.4	16.4
Module Resistance(Ohms)	3.22	3.63



\*\*Tolerances for thermal and electrical parameters  $\pm 10\%$ .

Performance Curves Th=25 °C

Performance Curves Th=50 °C



### Mechanical Drawing:



### Operation Tips:

- **Maximum Operating Temperature: 90°C**
- **Do not exceed  $I_{max}$  or  $V_{max}$  when operating module**
- **Please consult Wakefield-Vette for moisture and corrosion protection options as well as specific application inquiries**

# Thermoelectric Cooler Performance Specifications



## TEC-30-32-127

Hot Side Temperature(°C)	25 °C	50 °C
Qmax (Watts)	33.4	36.6
Delta Tmax(°C)	67	75
I <sub>max</sub> (Amps)	3.9	3.9
V <sub>max</sub> (Volts)	15.4	16.4
Module Resistance(Ohms)	3.37	3.8

\*\*Tolerances for thermal and electrical parameters ± 10%.

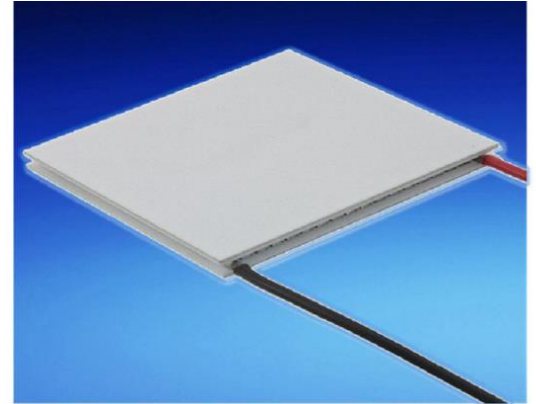

Performance Curves Th=25 °C

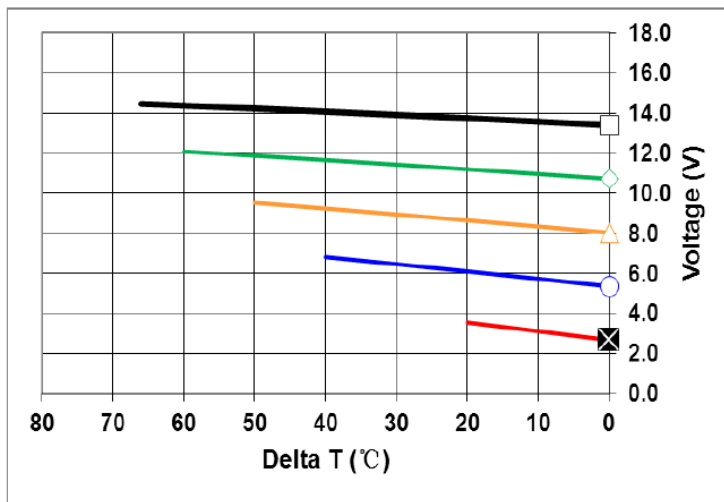

Performance Curves Th=50 °C

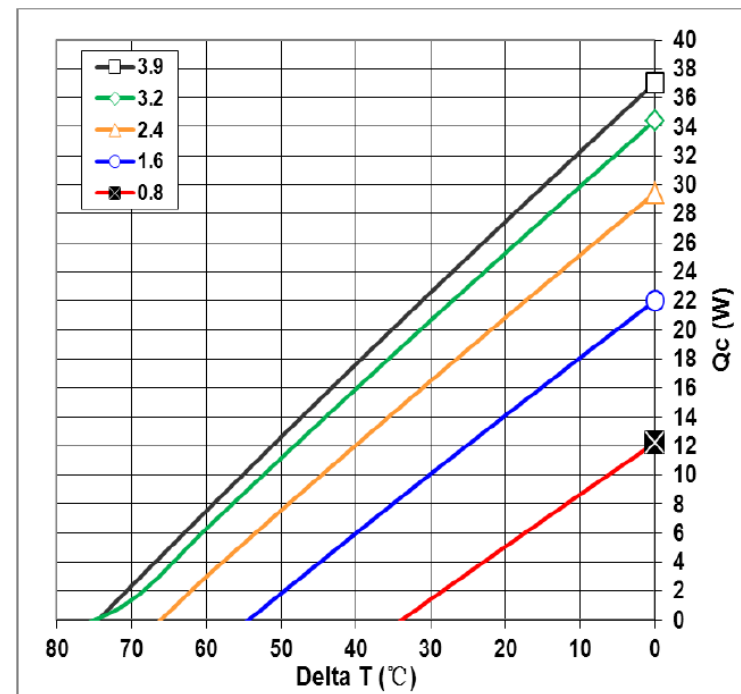
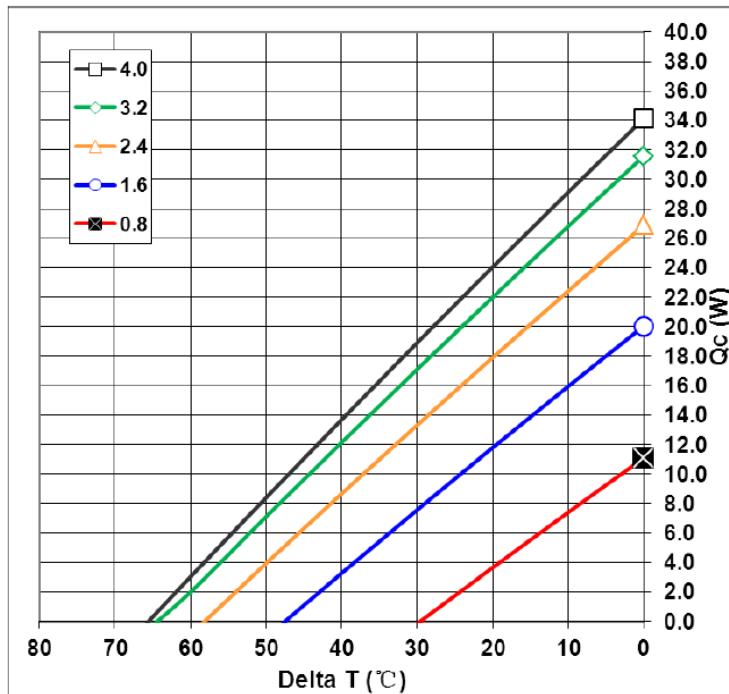
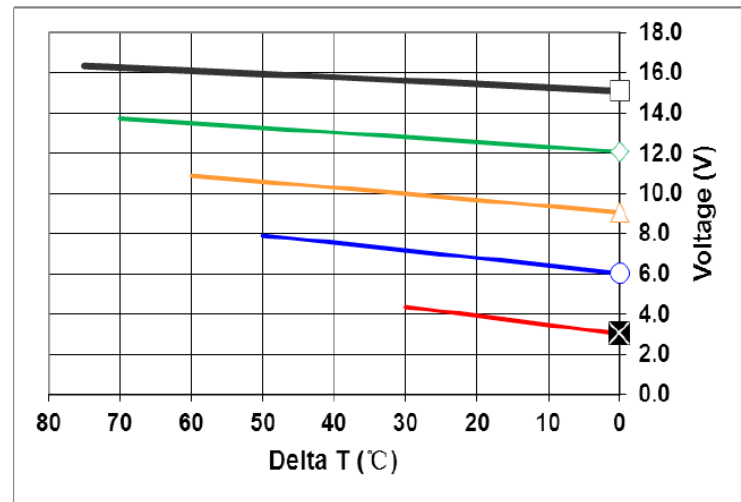

Mechanical Drawing:

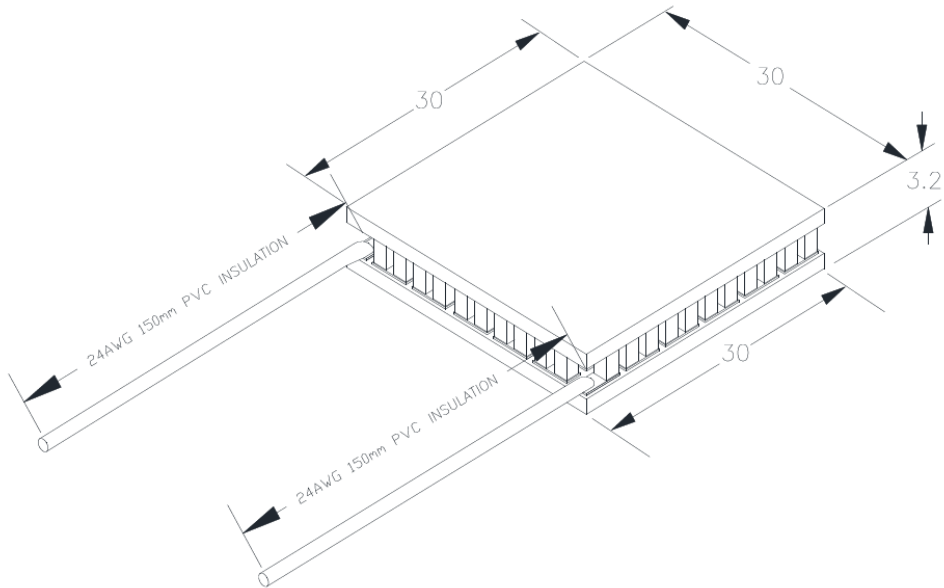

### Operation Tips:

- **Maximum Operating Temperature: 90°C**
- **Do not exceed  $I_{max}$  or  $V_{max}$  when operating module**
- **Please consult Wakefield-Vette for moisture and corrosion protection options as well as specific application inquiries**

# Thermoelectric Cooler Performance Specifications



## TEC-30-40-127

Hot Side Temperature(°C)	25 °C	50 °C
Qmax (Watts)	21.4	23.6
Delta Tmax(°C)	67	75
I <sub>max</sub> (Amps)	2.5	2.5
V <sub>max</sub> (Volts)	15.4	16.4
Module Resistance(Ohms)	5.38	6.07

\*\*Tolerances for thermal and electrical parameters ± 10%.

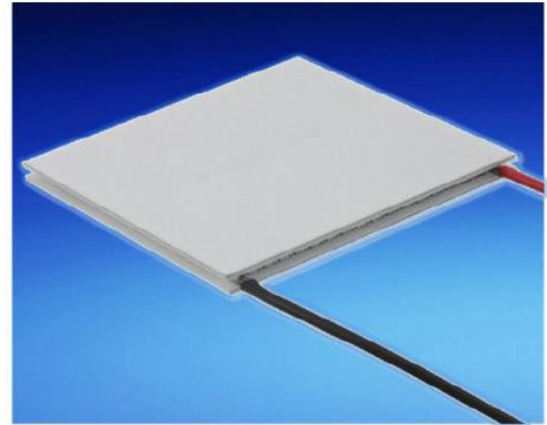

Performance Curves Th=25 °C

Performance Curves Th=50 °C

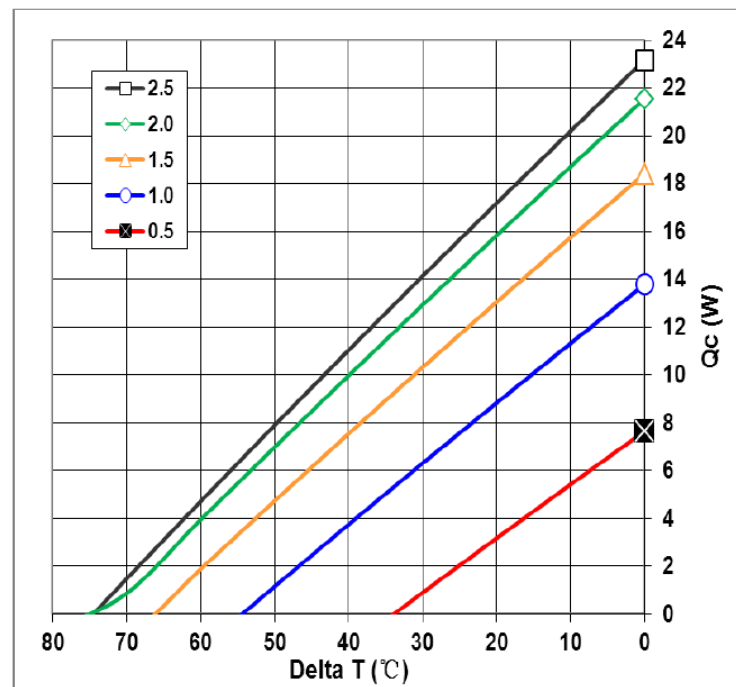
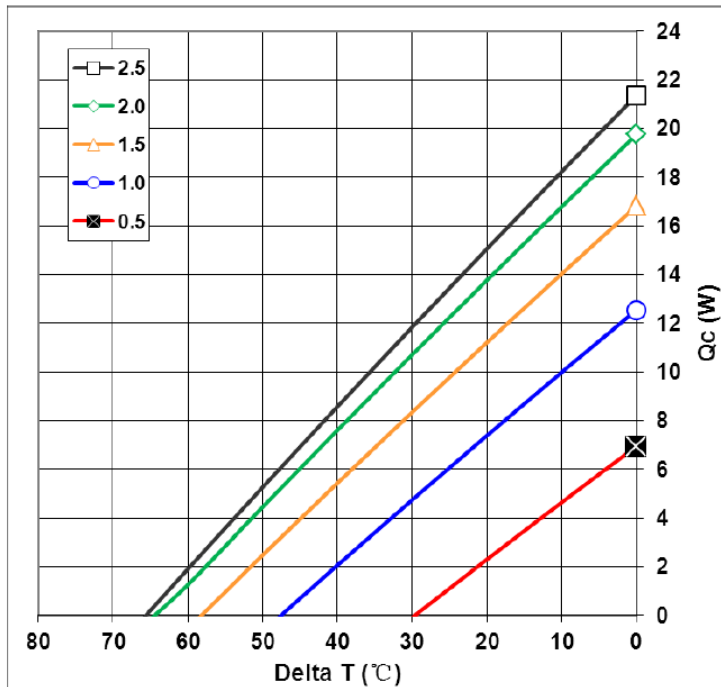
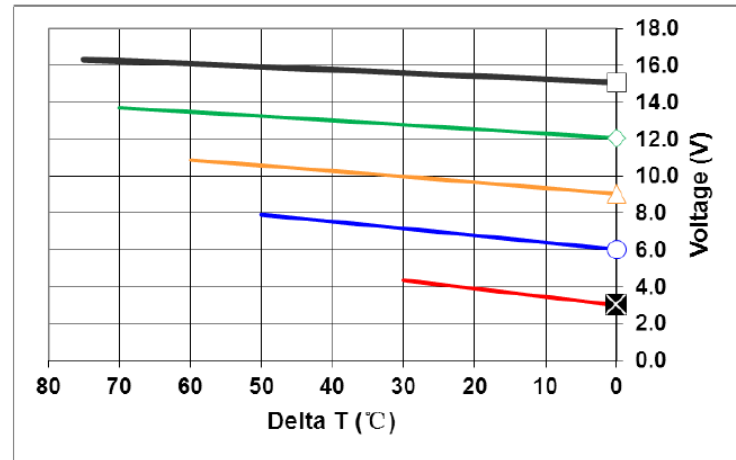
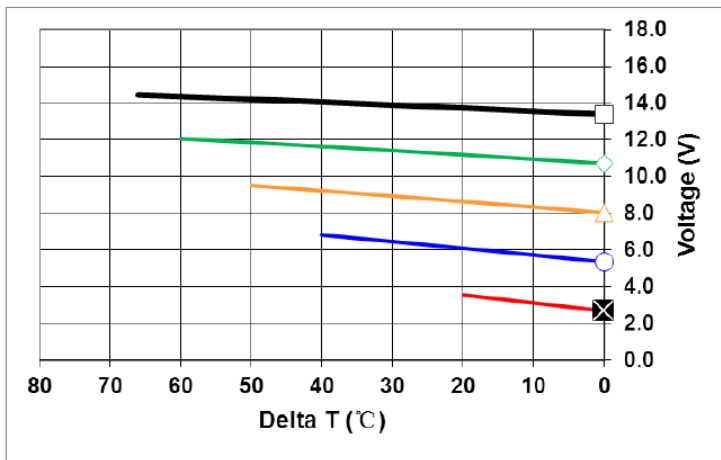

Wakefield-Vette reserves the right to change these specifications without notice

### Mechanical Drawing:

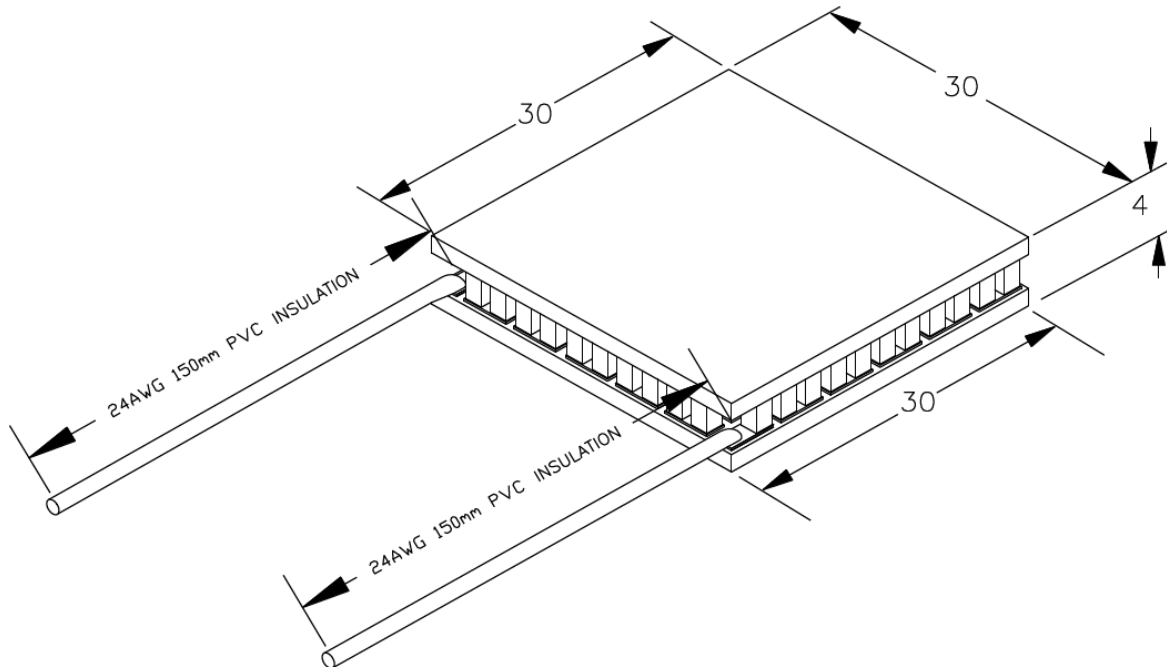

### Operation Tips:

- **Maximum Operating Temperature: 90°C**
- **Do not exceed  $I_{max}$  or  $V_{max}$  when operating module**
- **Please consult Wakefield-Vette for moisture and corrosion protection options as well as specific application inquiries**

# Thermoelectric Cooler Performance Specifications



## TEC-40-33-127

Hot Side Temperature(°C)	25 °C	50 °C
Qmax (Watts)	72	82
Delta Tmax(°C)	67	75
I <sub>max</sub> (Amps)	8.5	8.5
V <sub>max</sub> (Volts)	15.4	16.4
Module Resistance(Ohms)	1.54	1.74

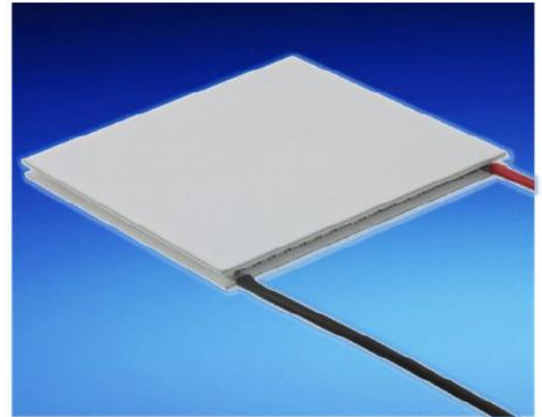

\*\*Tolerances for thermal and electrical parameters ± 10%.

Performance Curves Th=25 °C

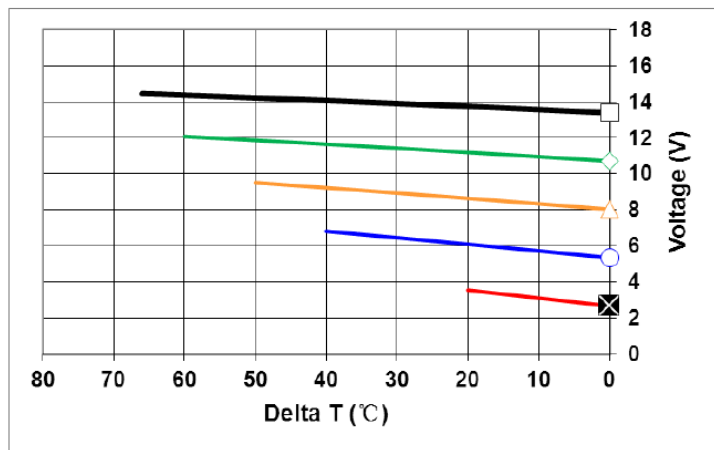

Performance Curves Th=50 °C

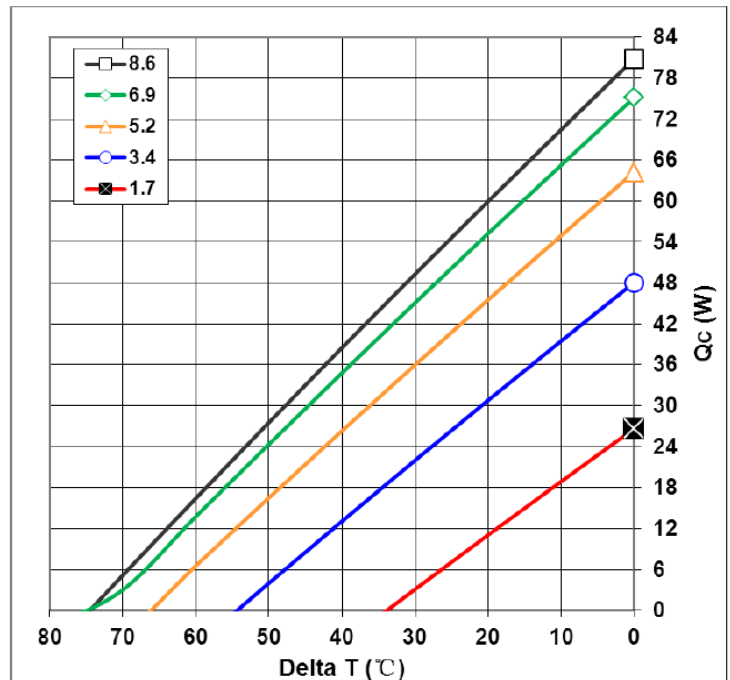
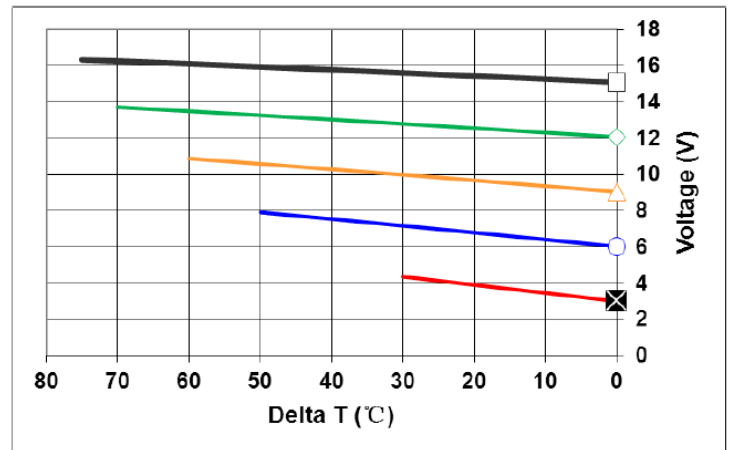



### Mechanical Drawing:

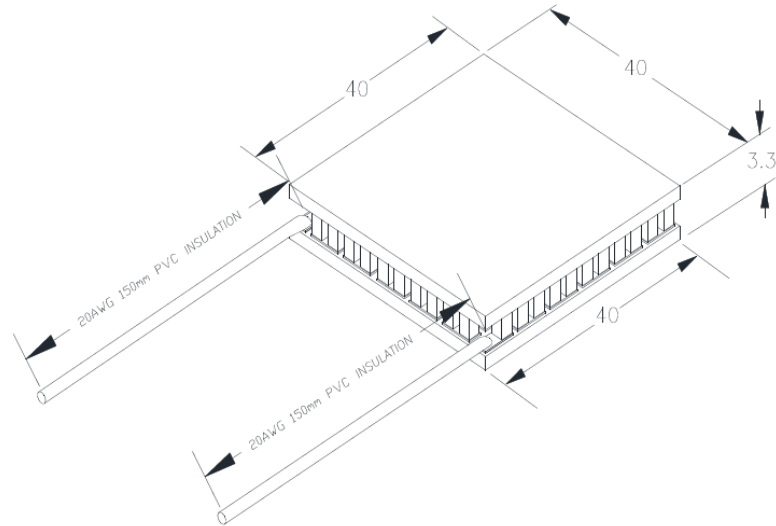

### Operation Tips:

- **Maximum Operating Temperature: 90°C**
- **Do not exceed  $I_{max}$  or  $V_{max}$  when operating module**
- **Please consult Wakefield-Vette for moisture and corrosion protection options as well as specific application inquiries**

# Thermoelectric Cooler Performance Specifications



## TEC-30-36-127

Hot Side Temperature(°C)	25 °C	50 °C
Qmax (Watts)	25.7	29.8
Delta Tmax(°C)	67	75
I <sub>max</sub> (Amps)	3	3
V <sub>max</sub> (Volts)	15.4	16.4
Module Resistance(Ohms)	4.16	4.69

\*\*Tolerances for thermal and electrical parameters ± 10%.

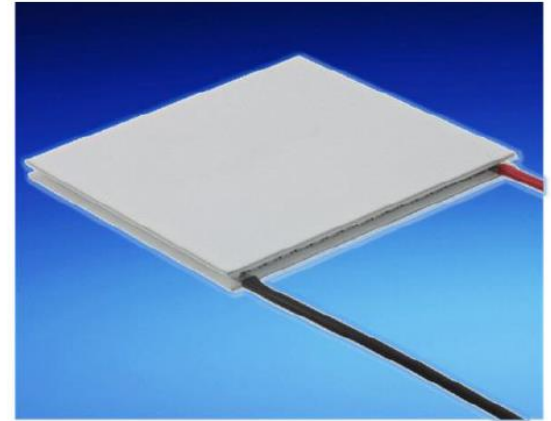

Performance Curves Th=25 °C

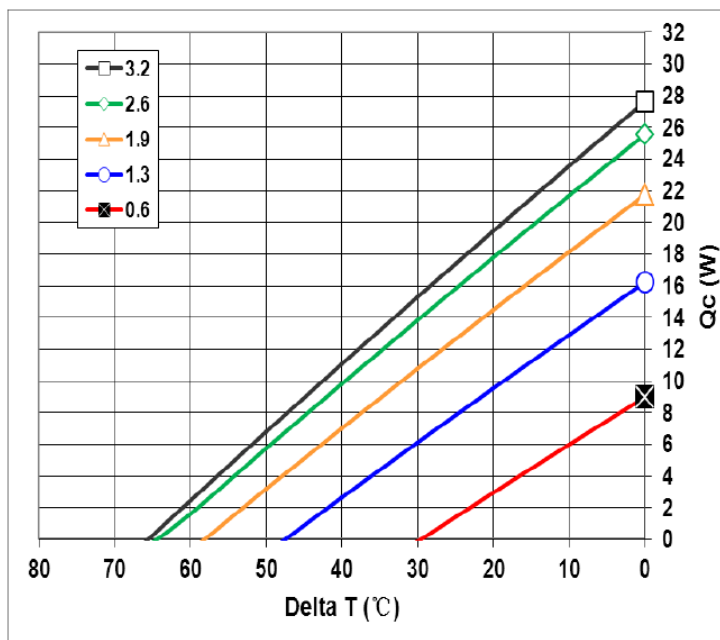
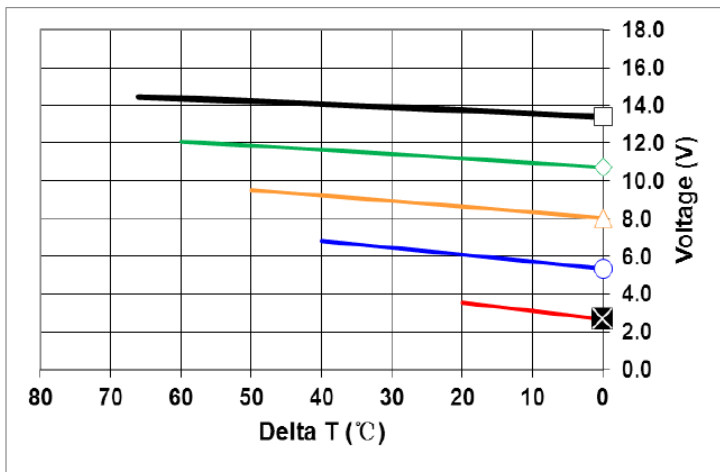

Performance Curves Th=50 °C

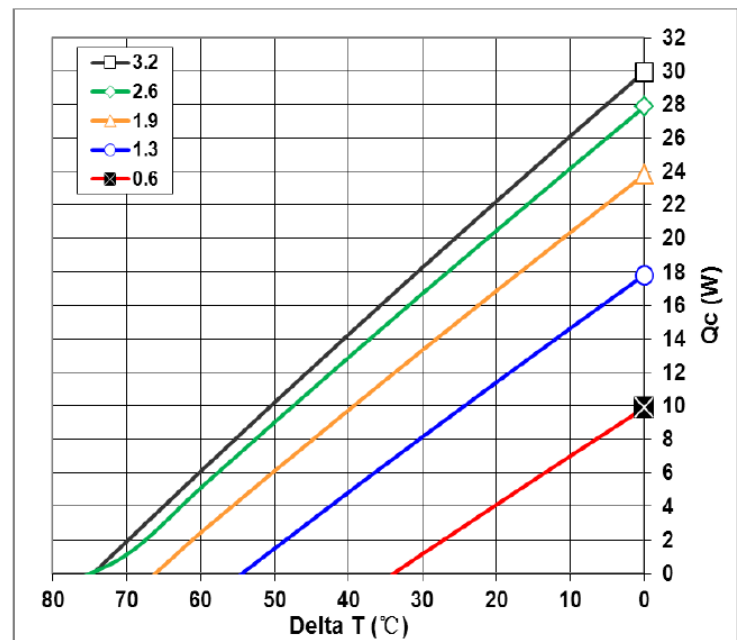
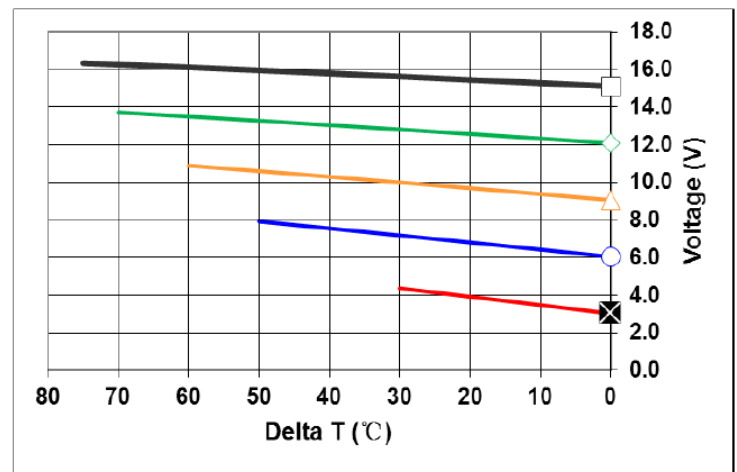

### Mechanical Drawing:

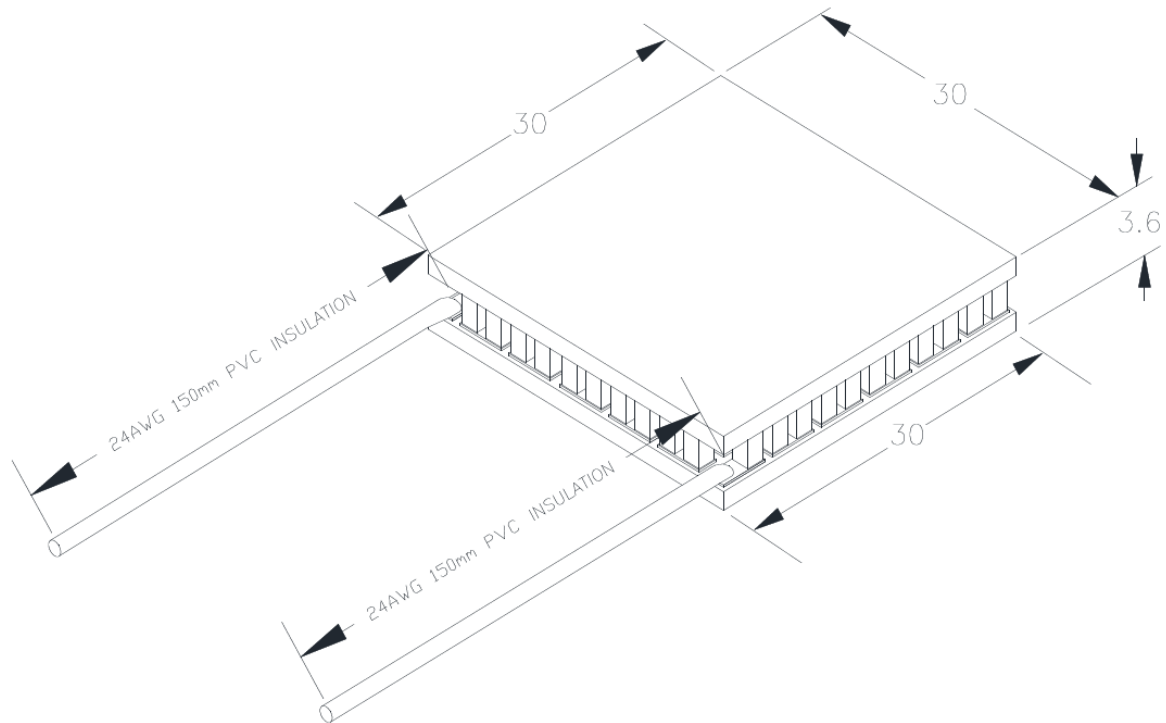

### Operation Tips:

- **Maximum Operating Temperature: 90°C**
- **Do not exceed  $I_{max}$  or  $V_{max}$  when operating module**
- **Please consult Wakefield-Vette for moisture and corrosion protection options as well as specific application inquiries**

# Thermoelectric Cooler Performance Specifications



## TEC-30-47-71

Hot Side Temperature(°C)	25 °C	50 °C
Qmax (Watts)	18.7	21.9
Delta Tmax(°C)	67	75
I <sub>max</sub> (Amps)	4	4
V <sub>max</sub> (Volts)	8.6	9.6
Module Resistance(Ohms)	1.8	2.1

\*\*Tolerances for thermal and electrical parameters ± 10%.



Performance Curves Th=25 °C

Performance Curves Th=50 °C



### Mechanical Drawing:

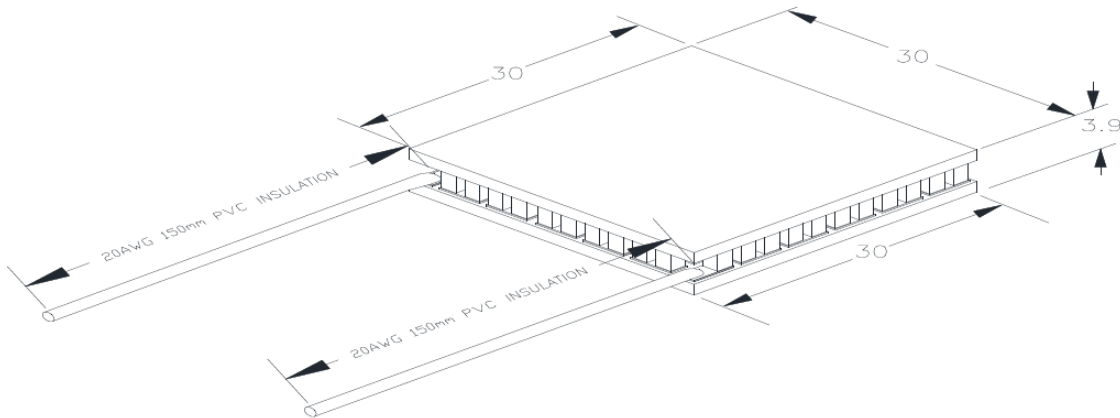

### Operation Tips:

- **Maximum Operating Temperature: 90°C**
- **Do not exceed  $I_{max}$  or  $V_{max}$  when operating module**
- **Please consult Wakefield-Vette for moisture and corrosion protection options as well as specific application inquiries**

# Thermoelectric Cooler Performance Specifications



## TEC-30-38-71

Hot Side Temperature(°C)	25 °C	50 °C
Qmax (Watts)	28.7	31.2
Delta Tmax(°C)	67	75
I <sub>max</sub> (Amps)	6	6
V <sub>max</sub> (Volts)	8.6	9.5
Module Resistance(Ohms)	0.55	0.62

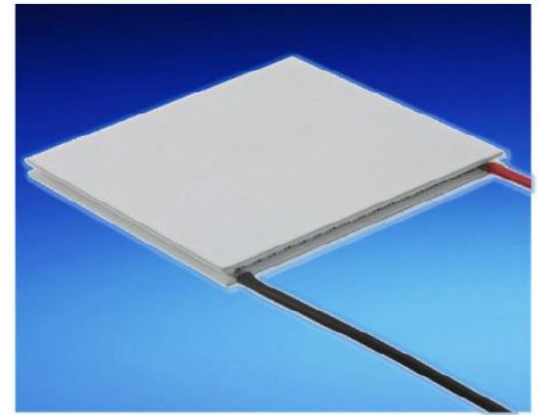

\*\*Tolerances for thermal and electrical parameters ± 10%.

Performance Curves Th=25 °C

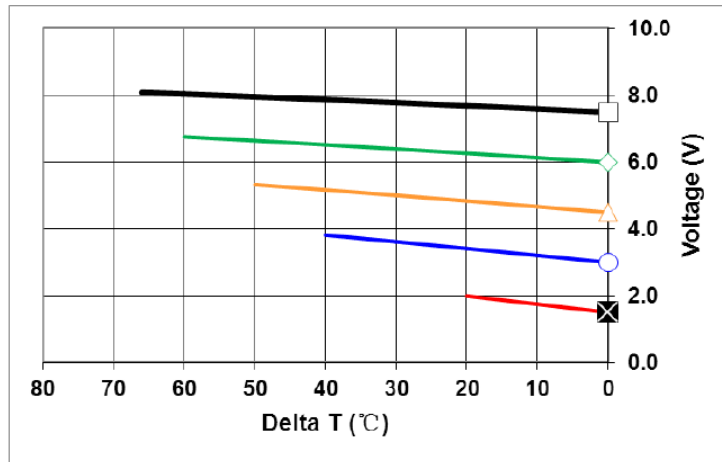

Performance Curves Th=50 °C

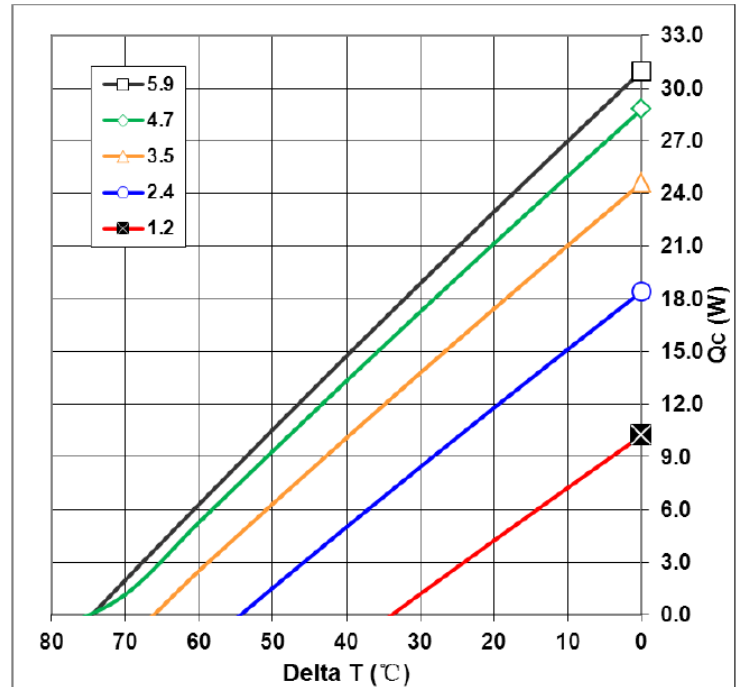
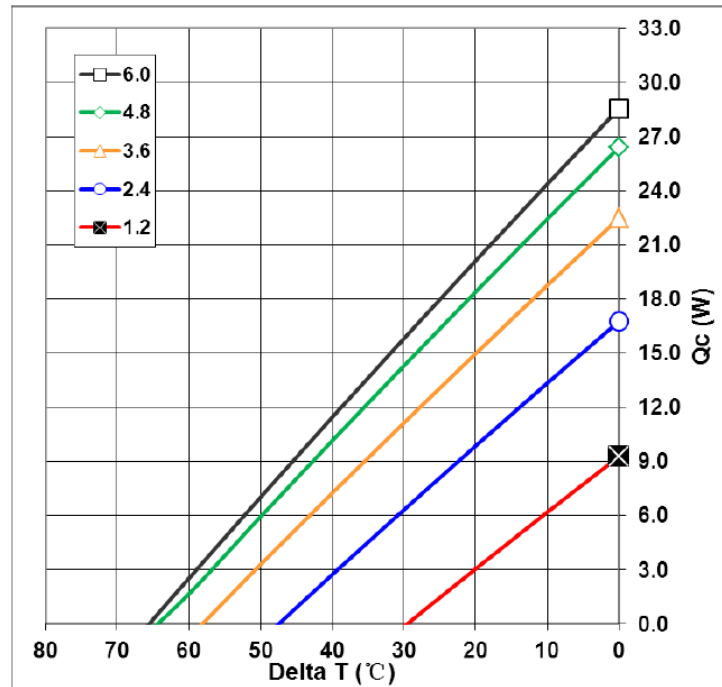
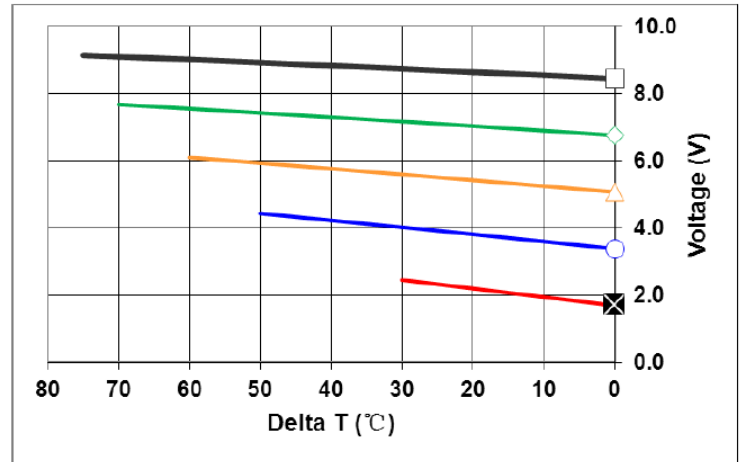

### Mechanical Drawing:

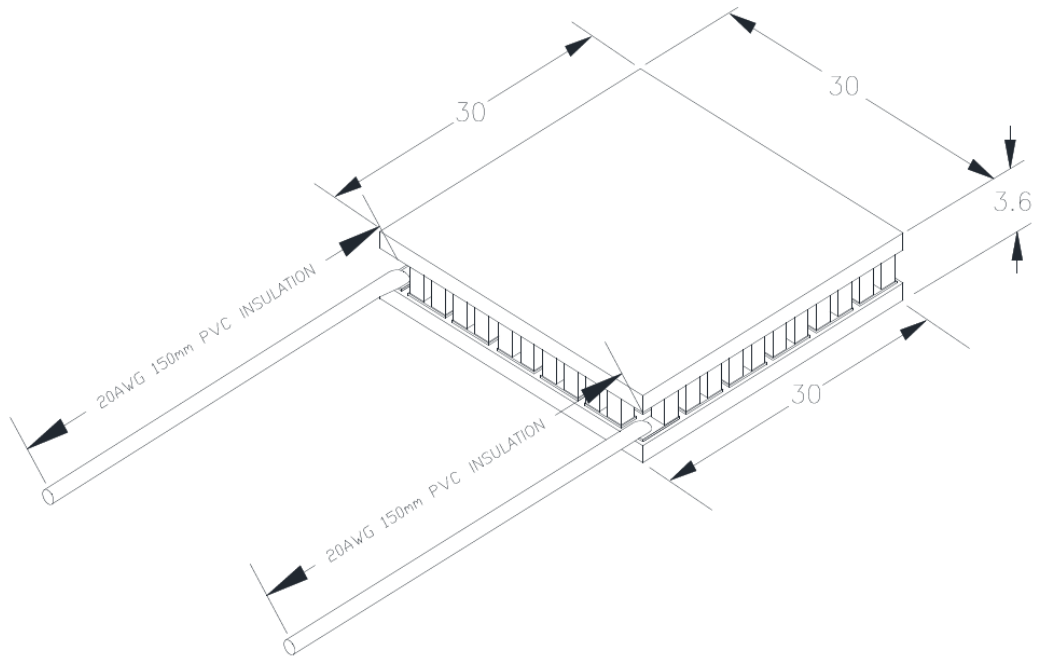

### Operation Tips:

- **Maximum Operating Temperature: 90°C**
- **Do not exceed  $I_{max}$  or  $V_{max}$  when operating module**
- **Please consult Wakefield-Vette for moisture and corrosion protection options as well as specific application inquiries**

# Thermoelectric Cooler Performance Specifications



## TEC-40-38-127

Hot Side Temperature(°C)	25 °C	50 °C
Qmax (Watts)	51.4	55
Delta Tmax(°C)	67	75
I <sub>max</sub> (Amps)	6	6
V <sub>max</sub> (Volts)	15.4	16.4
Module Resistance(Ohms)	2.25	2.54

\*\*Tolerances for thermal and electrical parameters ± 10%.

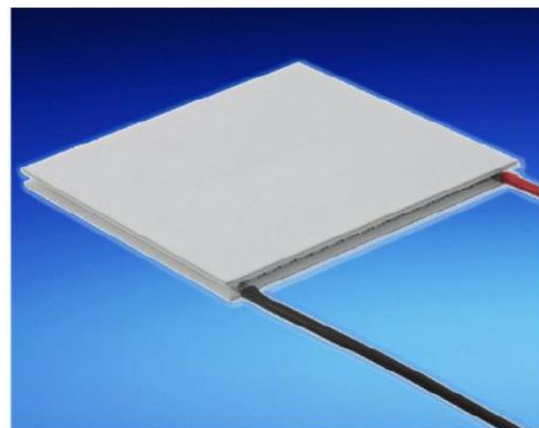

Performance Curves Th=25 °C

Performance Curves Th=50 °C

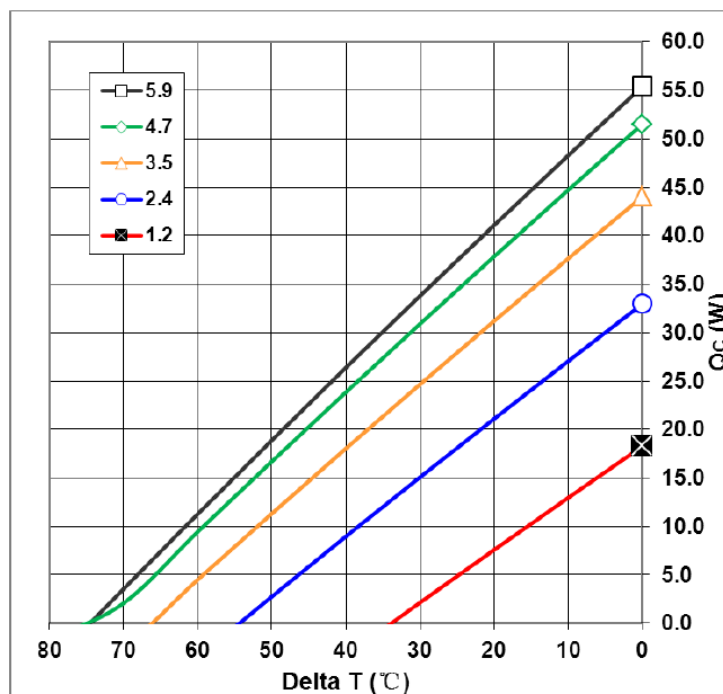
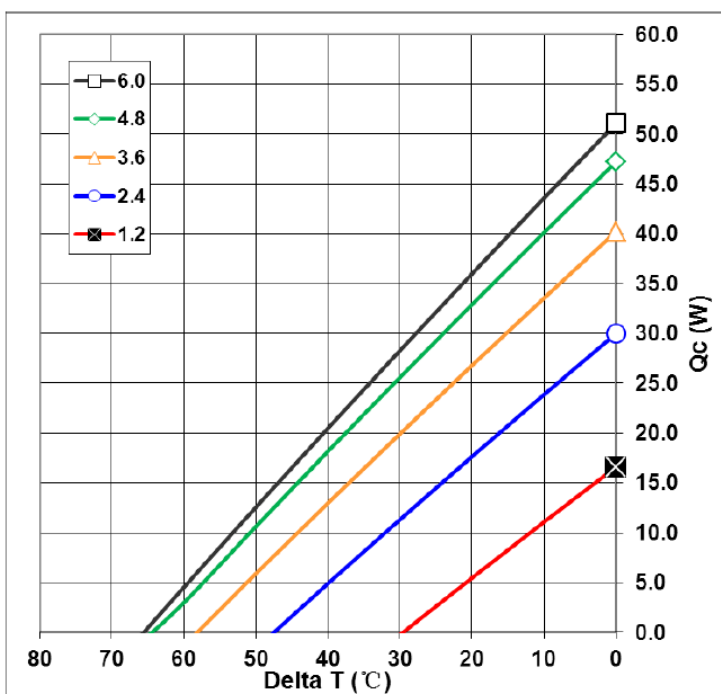
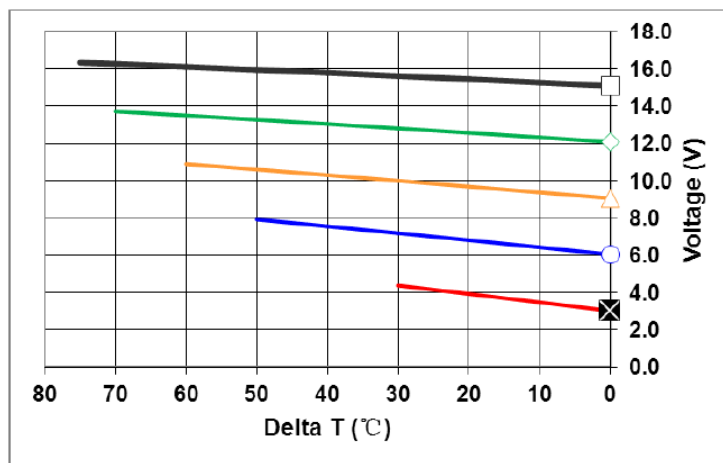
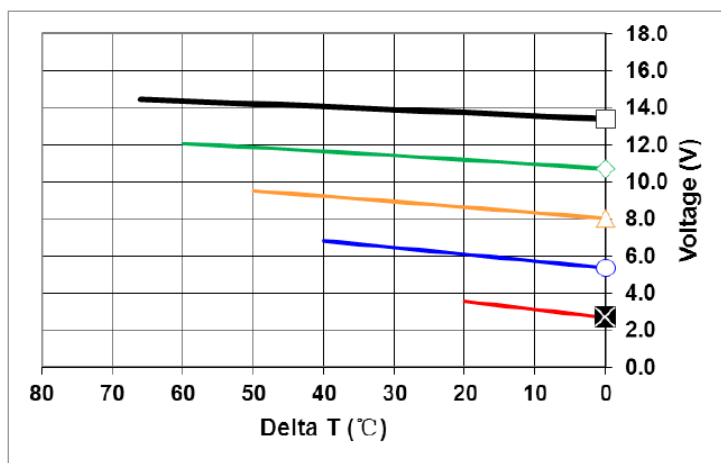

Wakefield-Vette reserves the right to change these specifications without notice



### Mechanical Drawing:



### Operation Tips:

- **Maximum Operating Temperature: 90°C**
- **Do not exceed  $I_{max}$  or  $V_{max}$  when operating module**
- **Please consult Wakefield-Vette for moisture and corrosion protection options as well as specific application inquiries**

# Thermoelectric Cooler Performance Specifications



## TEC-20-33-31

Hot Side Temperature(°C)	25 °C	50 °C
Qmax (Watts)	16.8	20.3
Delta Tmax(°C)	67	75
I <sub>max</sub> (Amps)	8.5	8.5
V <sub>max</sub> (Volts)	3.75	4.1
Module Resistance(Ohms)	0.38	0.42

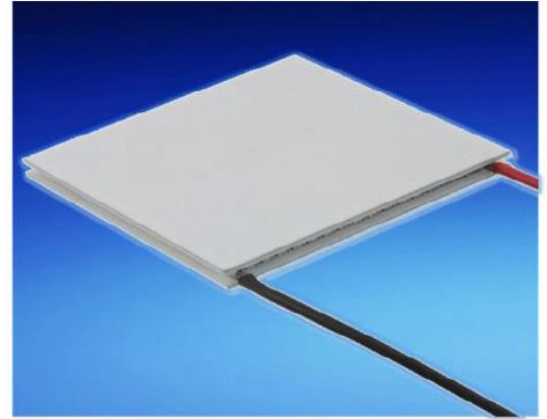

\*\*Tolerances for thermal and electrical parameters ± 10%.

Performance Curves Th=25 °C

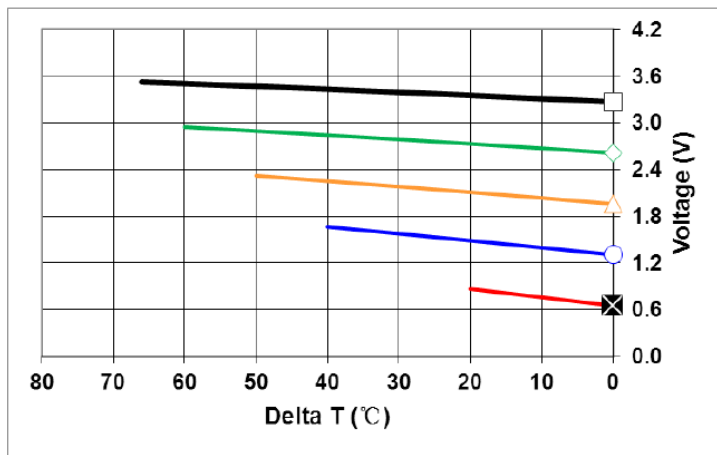

Performance Curves Th=50 °C

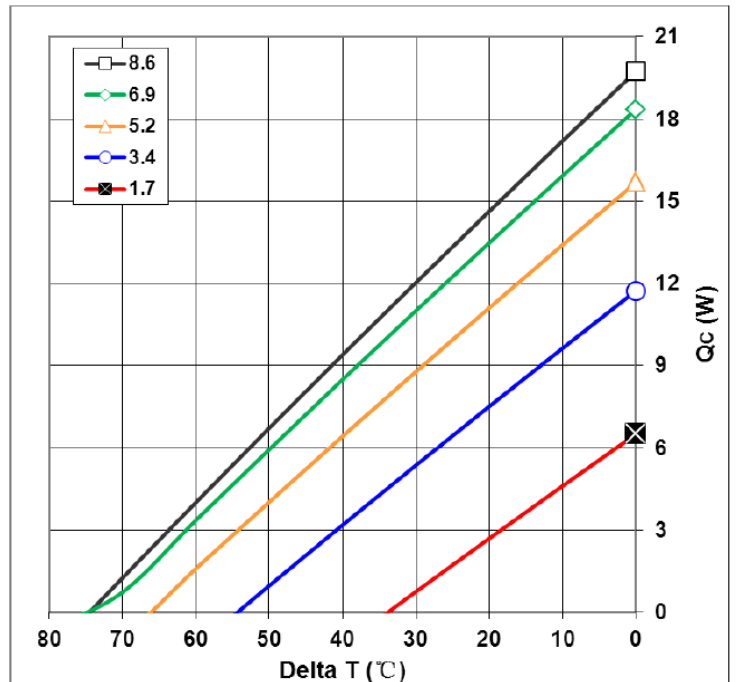
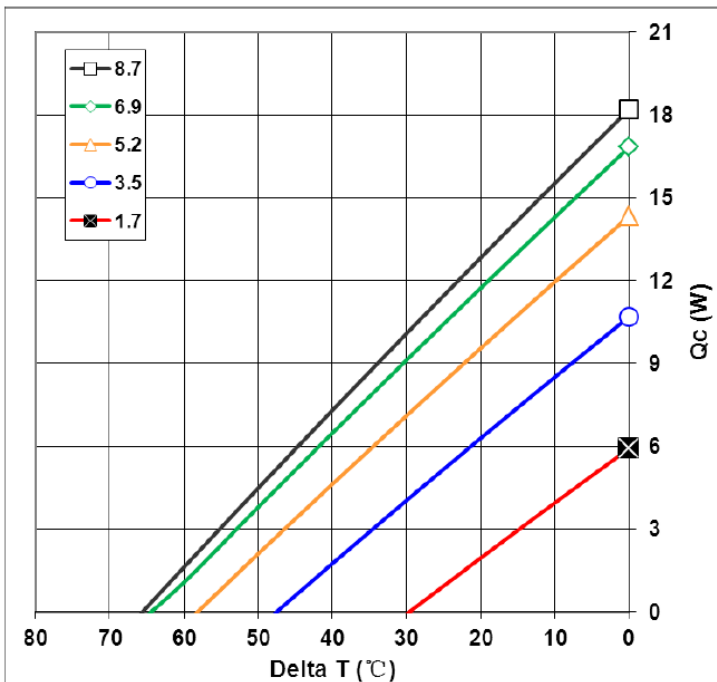
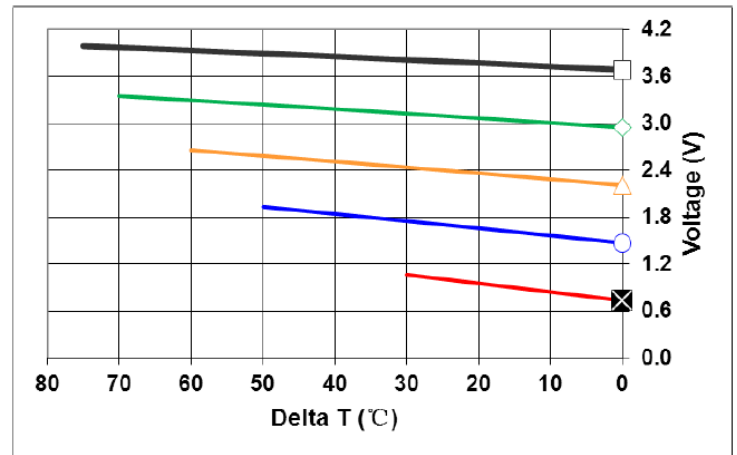

Mechanical Drawing:



### Operation Tips:

- **Maximum Operating Temperature: 90°C**
- **Do not exceed  $I_{max}$  or  $V_{max}$  when operating module**
- **Please consult Wakefield-Vette for moisture and corrosion protection options as well as specific application inquiries**

# Thermoelectric Cooler Performance Specifications



## TEC-30-33-71

Hot Side Temperature(°C)	25 °C	50 °C
Qmax (Watts)	38.5	46
Delta Tmax(°C)	67	75
I <sub>max</sub> (Amps)	8.5	8.5
V <sub>max</sub> (Volts)	8.6	9.6
Module Resistance(Ohms)	0.86	0.97

\*\*Tolerances for thermal and electrical parameters ± 10%.

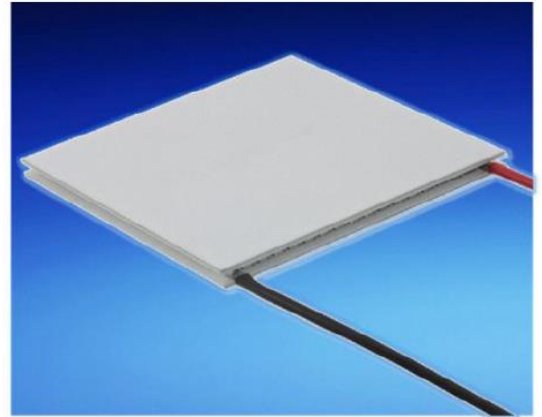

Performance Curves Th=25 °C

Performance Curves Th=50 °C

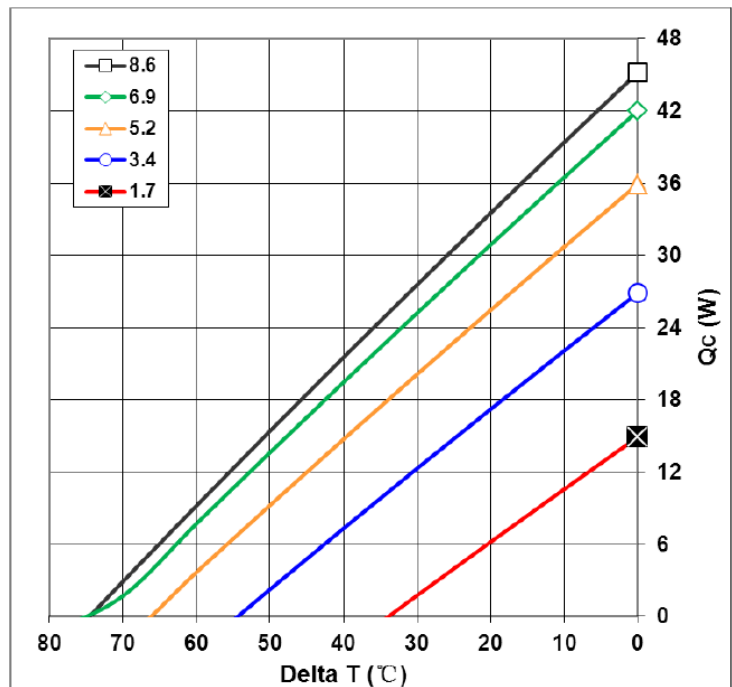
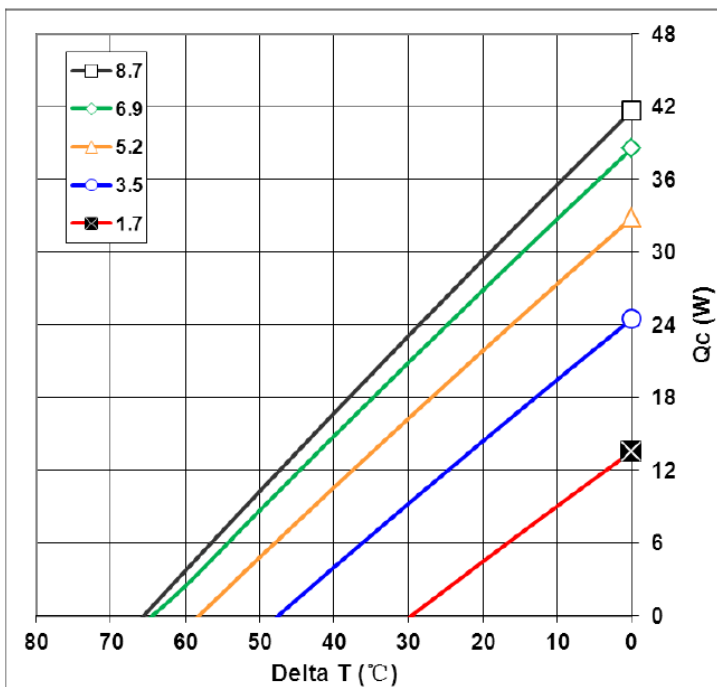
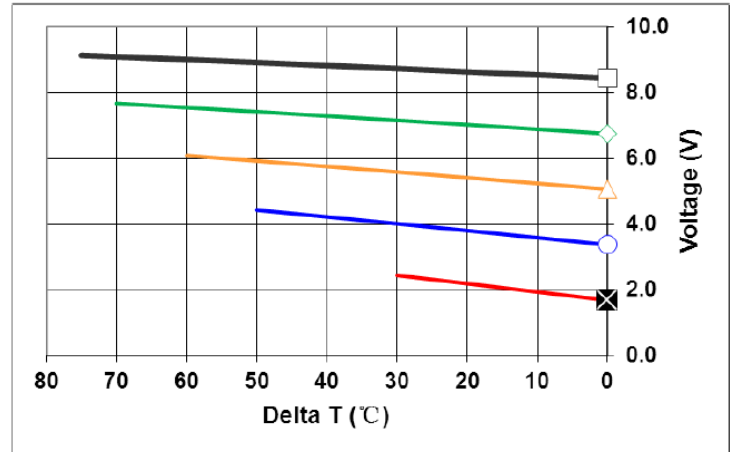
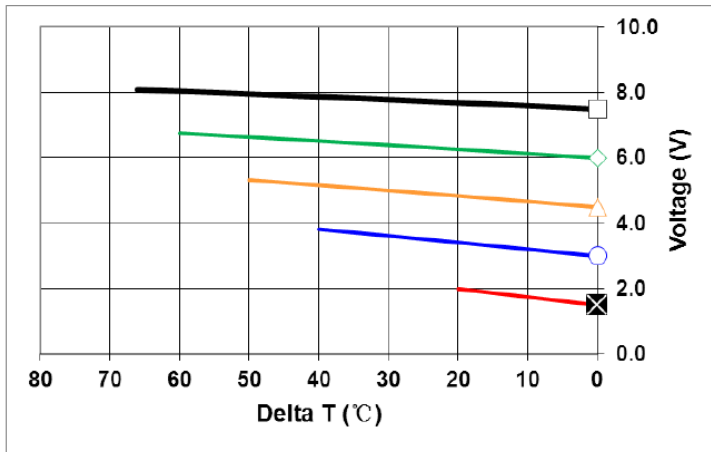

Mechanical Drawing:



### Operation Tips:

- **Maximum Operating Temperature: 90°C**
- **Do not exceed  $I_{max}$  or  $V_{max}$  when operating module**
- **Please consult Wakefield-Vette for moisture and corrosion protection options as well as specific application inquiries**

## Данный компонент на территории Российской Федерации

### Вы можете приобрести в компании MosChip.

Для оперативного оформления запроса Вам необходимо перейти по данной ссылке:

<http://moschip.ru/get-element>

Вы можете разместить у нас заказ для любого Вашего проекта, будь то серийное производство или разработка единичного прибора.

В нашем ассортименте представлены ведущие мировые производители активных и пассивных электронных компонентов.

Нашей специализацией является поставка электронной компонентной базы двойного назначения, продукции таких производителей как XILINX, Intel (ex.ALTERA), Vicor, Microchip, Texas Instruments, Analog Devices, Mini-Circuits, Amphenol, Glenair.

Сотрудничество с глобальными дистрибьюторами электронных компонентов, предоставляет возможность заказывать и получать с международных складов практически любой перечень компонентов в оптимальные для Вас сроки.

На всех этапах разработки и производства наши партнеры могут получить квалифицированную поддержку опытных инженеров.

Система менеджмента качества компании отвечает требованиям в соответствии с ГОСТ Р ИСО 9001, ГОСТ РВ 0015-002 и ЭС РД 009

### Офис по работе с юридическими лицами:

105318, г.Москва, ул.Щербаковская д.3, офис 1107, 1118, ДЦ «Щербаковский»

Телефон: +7 495 668-12-70 (многоканальный)

Факс: +7 495 668-12-70 (доб.304)

E-mail: [info@moschip.ru](mailto:info@moschip.ru)

Skype отдела продаж:

moschip.ru

moschip.ru\_4

moschip.ru\_6

moschip.ru\_9