

**HIGH EFFICIENCY LOW EMI WIDE ANALOG
DIMMING RANGE 36V 1A/1.3A BUCK LED DRIVER**

NEW PRODUCT

Description

The AL8807A is a step-down DC/DC converter designed to drive LEDs with a constant current. The device can drive up to 9 white high brightness LEDs in series from a voltage source of 6V to 36V.

The AL8807A has an extended CTRL pin voltage range; increasing its analog dimming range to greater than 10:1. The improved analog dimming range makes it suitable for a variety of lighting applications requiring wide analog dimming ranges.

The AL8807A switches at frequency up to 1MHz with controlled rise and fall times to reduce EMI. This allows the use of small size external components, hence minimizing the PCB area needed.

Maximum output current of AL8807A is set via an external resistor connected between the V_{IN} and SET input pins.

Over Temperature Protection is incorporated so that should a fault occur the device will automatically shut-down and only restart when its junction temperature has cooled down,

Features

- LED Driving Current up to 1A/1.3A
- Better than 5% Accuracy
- High Efficiency Up to 96%
- Optimally Controlled Switching Speeds
- Operating Input Voltage from 6V to 36V
- Wide Analog Input Range for Dimming Control (>10:1)
- Built-in Protection Features:
 - Open-Circuit LED protection
 - LED Chain Short Circuited
 - Over-Temperature Protection
- MSOP-8EP and SOT25: Available in "Green" Molding Compound (No Br, Sb) with lead Free Finish/ RoHS Compliant
 - **Totally Lead-Free & Fully RoHS Compliant (Notes 1 & 2)**
 - **Halogen and Antimony Free. "Green" Device (Note 3)**

Notes: 1. No purposely added lead. Fully EU Directive 2002/95/EC (RoHS) & 2011/65/EU (RoHS 2) compliant.
 2. See <http://www.diodes.com> for more information about Diodes Incorporated's definitions of Halogen and Antimony free, "Green" and Lead-Free.
 3. Halogen and Antimony free "Green" products are defined as those which contain <900ppm bromine, <900ppm chlorine (<1500ppm total Br + Cl) and <1000ppm antimony compounds.

Pin Assignments

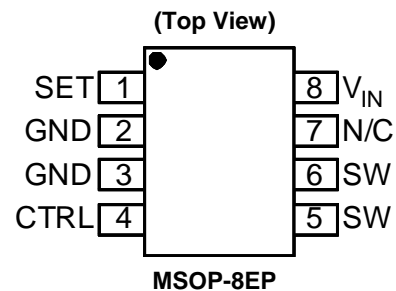
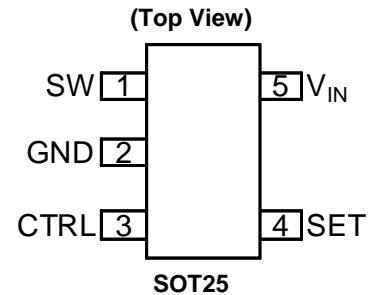

Applications

- General Illumination Lamps
- 12V Powered LED Lamps
- Wide Analog Dimming Range LED Lamps

Typical Applications Circuit

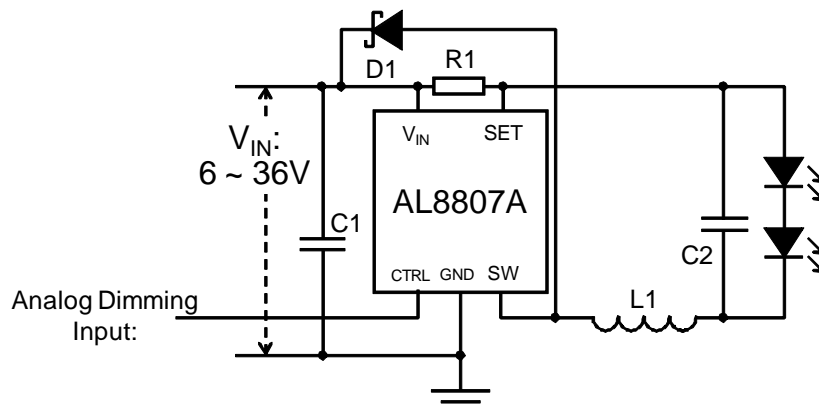

Pin Descriptions

Pin Name	Pin Number		Function
	SOT25	MSOP-8EP	
SW	1	5, 6	Switch Pin. Connect inductor/freewheeling diode here, minimizing track length at this pin to reduce EMI.
GND	2	2, 3	GND Pin
CTRL	3	4	LED current Analog Dimming Control Input. – No PWM dimming function. Connected to internal 2.5V V_{REF} via 50k Ω resistor. So if left open circuit $V_{CTRL} = V_{REF} = 2.5V$ and 100% LED current is achieved - giving nominal average output current $I_{OUTnom} = 0.1/R_S$ For Analog dimming drive with analog voltage < 2.5V ($0.25V < V_{CTRL} < 2.5V$ adjusts output current from 10% to 100% of I_{OUTnom} . Device will dim the LED current lower than this level but at reduced accuracy. Some devices will not totally turn off the LED current. Soft-start can be implemented by connecting a capacitor to CTRL pin. The amount of soft-start is dependent on ramp-up of input supply voltage and capacitor on CTRL pin. See apps section.
SET	4	1	Set Nominal Output Current Pin. Configure the output current of the device.
V_{IN}	5	8	Input Supply Pin. Must be locally decoupled to GND with $\geq 2.2\mu F$ X7R ceramic capacitor – see applications section for more information.
EP	—	EP	Exposed pad/TAB. It should be connected to GND and thermal mass for enhanced thermal impedance. It should not be used as electrical ground conduction path.
N/C	—	7	No connection – may be connected to GND.

Functional Block Diagram

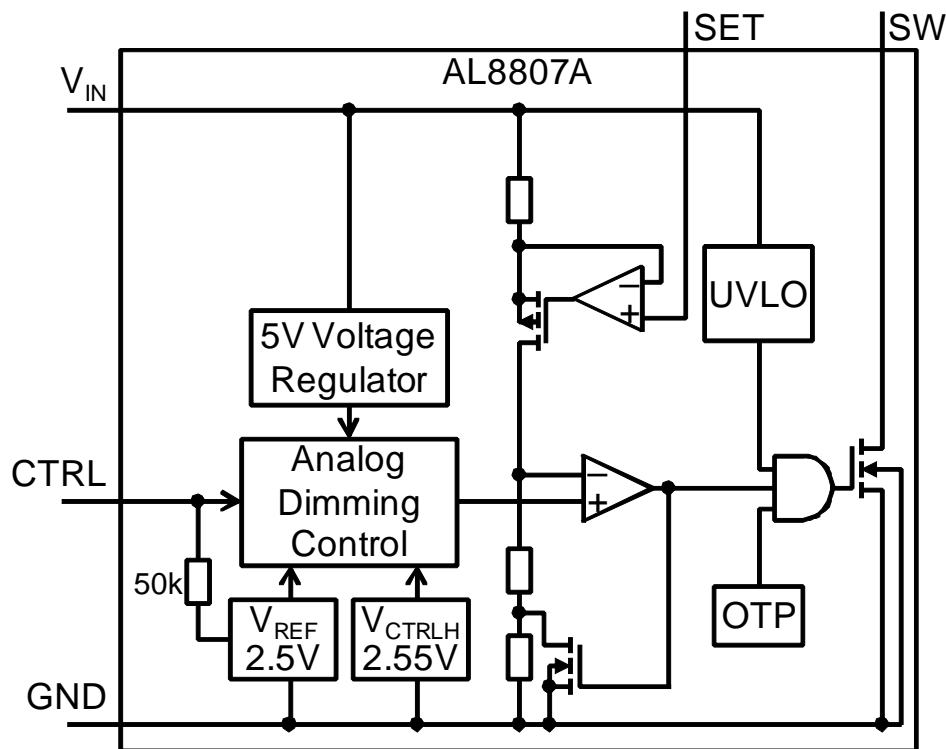

Absolute Maximum Ratings (@T_A = +25°C, unless otherwise specified.)

Symbol	Parameter	Ratings	Unit
ESD HBM	Human Body Model ESD Protection	2.5	kV
ESD MM	Machine Model ESD Protection	200	V
V _{IN}	Continuous V _{IN} Pin Voltage Relative to GND	-0.3 to +40	V
V _{SW}	SW Voltage Relative to GND	-0.3 to +40	V
V _{CTRL}	CTRL Pin Input Voltage	-0.3 to +6	V
I _{SW-RMS}	DC or RMS Switch Current	SOT25	1.25
		MSOP-8EP	1.5
I _{SW-PK}	Peak Switch Current (< 10% duty cycle)	2.5	A
T _J	Junction Temperature	150	°C
T _{LEAD}	Lead Temperature Soldering	300	°C
T _{ST}	Storage Temperature Range	-65 to +150	°C

Caution: Stresses greater than the 'Absolute Maximum Ratings' specified above, may cause permanent damage to the device. These are stress ratings only; functional operation of the device at these or any other conditions exceeding those indicated in this specification is not implied. Device reliability may be affected by exposure to absolute maximum rating conditions for extended periods of time. Semiconductor devices are ESD sensitive and may be damaged by exposure to ESD events. Suitable ESD precautions should be taken when handling and transporting these devices.

Recommended Operating Conditions (@T_A = +25°C, unless otherwise specified.)

Symbol	Parameter	Min	Max	Unit
V _{IN}	Operating Input Voltage	6.0	36	V
V _{CTRL}	CTRL Pin Input Voltage Range for 10% to 100% ANALOG Dimming (Note 4)	0.25	2.50	V
f _{SW}	Maximum Switching Frequency at 100% dimming		0.7	MHz
I _{SW}	Continuous Switch Current (Note 5)	SOT25	1	A
		MSOP-8EP	1.3	
T _J	Junction Temperature Range	-40	+125	°C

Notes: 4. AL8807A analog dimming range extends below 10% but at reduced LED current accuracies and may not turn completely off. Switching frequencies will also be increased.
5. Maximum switch current is dependent on power dissipation and junction temperature.

Electrical Characteristics (@T_A = +25°C, unless otherwise specified.)

Symbol	Parameter	Conditions	Min	Typ	Max	Unit
V _{INSU}	Internal Regulator Start Up Threshold	V _{IN} rising			5.9	V
V _{INSH}	Internal Regulator Hysteresis Threshold	V _{IN} falling	100		300	mV
I _Q	Quiescent Current	CTRL pin floating			350	μA
I _S	Input Supply Current	Output not switching (Note 6) f = 250kHz		1.8	5	mA
V _{TH}	Set Current Threshold Voltage	CTRL pin floating	95	100	105	mV
V _{TH-H}	Set Threshold Hysteresis			±20		%
V _{TH-10%}	10% Set Current Threshold Voltage	V _{CTRL} = 0.25V	4	10	15	mV
I _{SET}	SET Pin Input Current	V _{SET} = V _{IN} - 0.1		16	22	μA
R _{CTRL}	CTRL Pin Input Resistance	Referred to internal reference		50		kΩ
V _{REF}	Internal Reference Voltage			2.5		V
R _{DS(on)}	On Resistance of SW MOSFET	I _{SW} = 0.3A	SOT25	0.25	0.40	Ω
			MSOP-8EP	0.18	0.35	
t _R	SW Rise Time	V _{SENSE} = 100 ±20mV, f _{SW} = 250kHz		12		ns
t _F	SW Fall Time	V _{SW} = 0.1V ~ 12V ~ 0.1V, C _L = 15pF		20		ns
I _{SW_Leakage}	Switch Leakage Current	V _{IN} = 36V			0.5	μA
T _{OTP}	Over-Temperature Shutdown			150		°C
T _{OTP-Hyst}	Over-Temperature Hysteresis			25		°C
θ _{JA}	Thermal Resistance Junction-to-Ambient (Note 7)	SOT25 (Note 8)		250		°C/W
		MSOP-8EP (Note 9)		69		
θ _{JL}	Thermal Resistance Junction-to-Lead (Note 10)	SOT25 (Note 8)		50		
θ _{JC}	Thermal Resistance Junction-to-case (Note 11)	MSOP-8EP (Note 9)		4.3		

- Notes:
- AL8807A does not have a low power standby mode but current consumption is reduced when output is not being switched.
 - Refer to Figure 40 for the device derating curve.
 - Test condition for SOT25: Device mounted on FR-4 PCB (25mm x 25mm 1oz copper, minimum recommended pad layout on top layer and thermal vias to bottom layer ground plane. For better thermal performance, larger copper pad for heat-sink is needed.
 - Test condition for MSOP-8EP: Device mounted on FR-4 PCB (51mm x 51mm 2oz copper, minimum recommended pad layout on top layer and thermal vias to bottom layer with maximum area ground plane. For better thermal performance, larger copper pad for heat-sink is needed.
 - Dominant conduction path via Gnd pin (pin 2).
 - Dominant conduction path via exposed pad.

Typical Performance Characteristics (@ $T_A = +25^\circ\text{C}$, unless otherwise specified.)

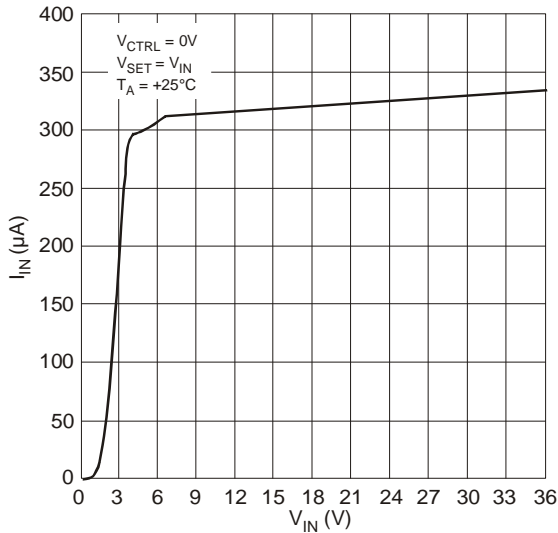

Figure 1 Supply Current (not switching) vs. Input Voltage

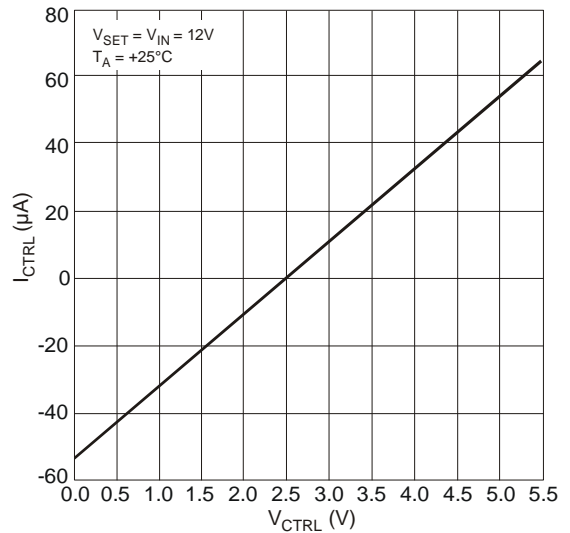

Figure 2 I_{CTRL} vs. V_{CTRL}

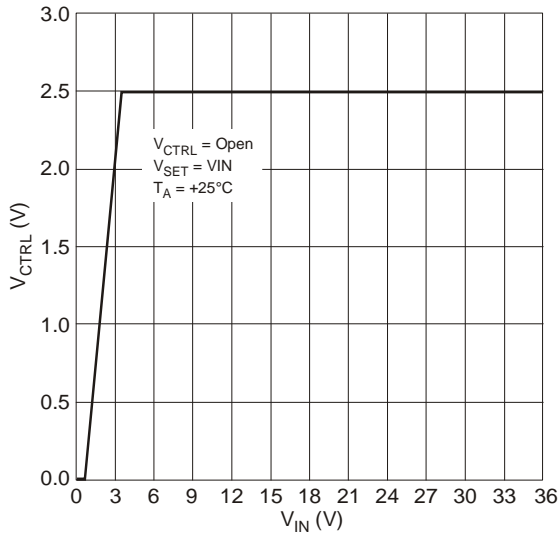

Figure 3 V_{CTRL} vs. Input Voltage (CTRL pin open circuit)

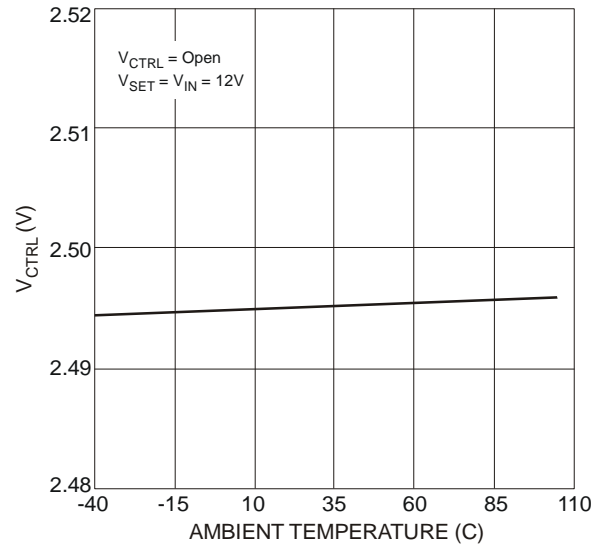

Figure 4 V_{CTRL} vs. Temperature

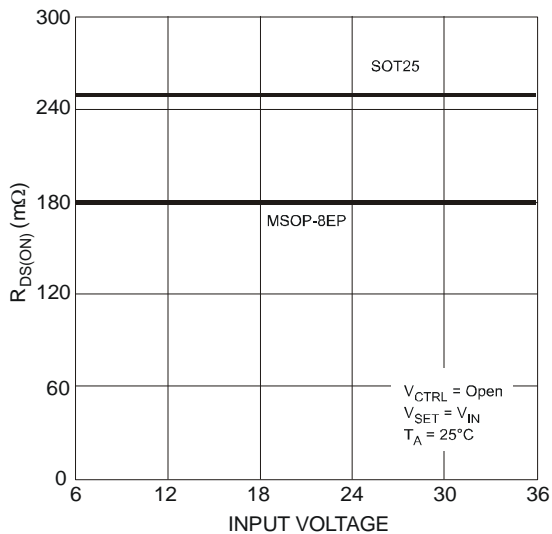

Figure 5 SW $R_{DS(ON)}$ vs. Input Voltage

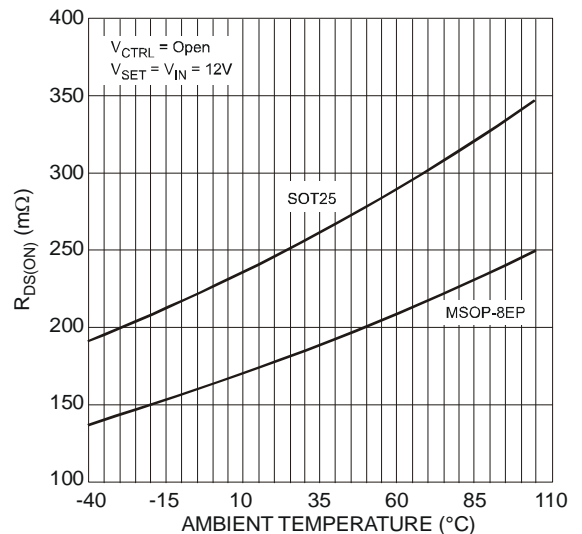

Figure 6 SW $R_{DS(ON)}$ vs. Temperature

Typical Performance Characteristics (cont.) (@ $T_A = +25^\circ\text{C}$, unless otherwise specified.)

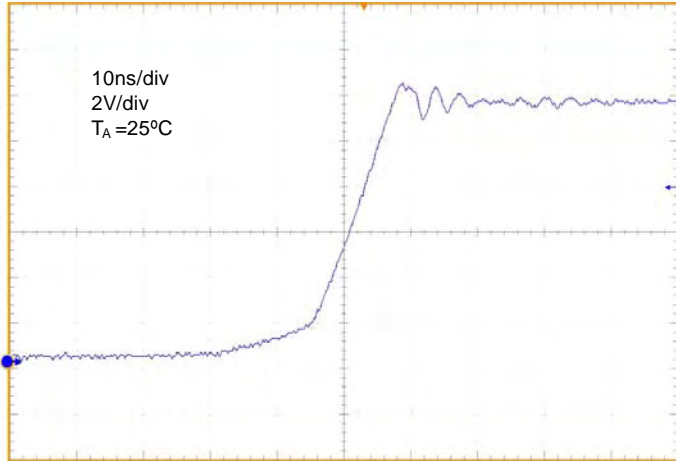

Figure 7 SW Output Rise Time

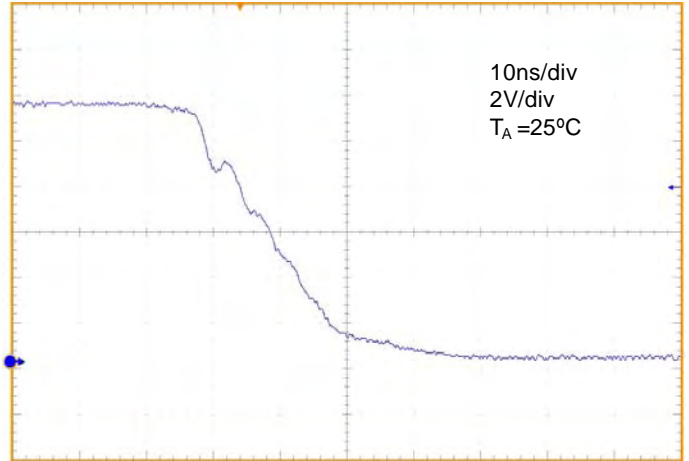

Figure 8 SW Output Fall Time

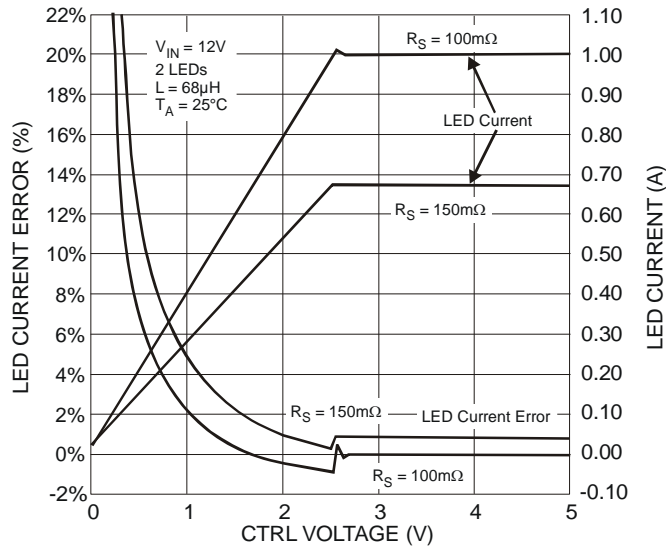

Figure 9 LED Current (Different Sense Resistor) vs. V_{CTRL}

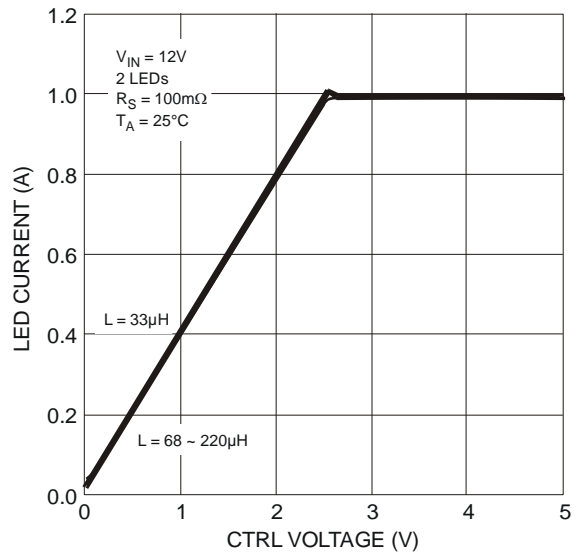

Figure 10 LED Current (Different Inductor) vs. V_{CTRL}

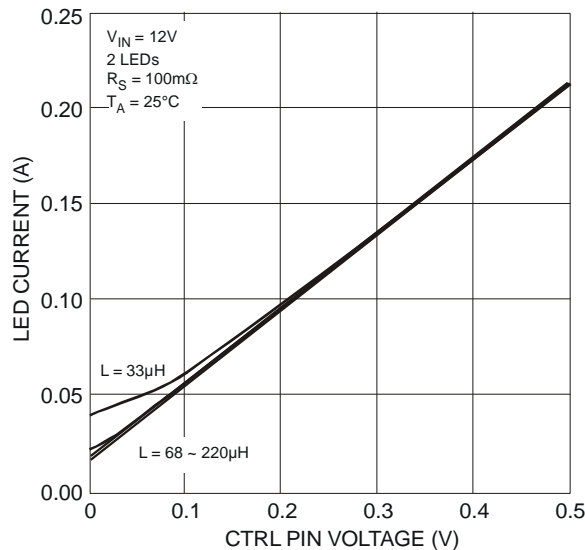

Figure 11 LED Current (Zoomed In) vs. V_{CTRL}

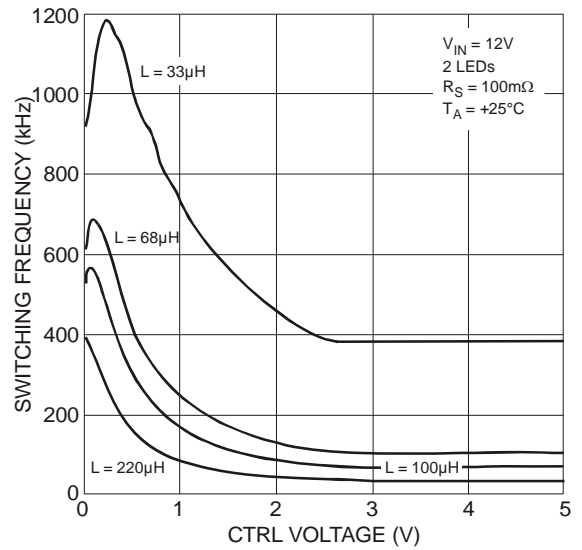

Figure 12 Switching Frequency vs. V_{CTRL}

Typical Performance Characteristics (cont.) (@ $T_A = +25^\circ\text{C}$, unless otherwise specified.)

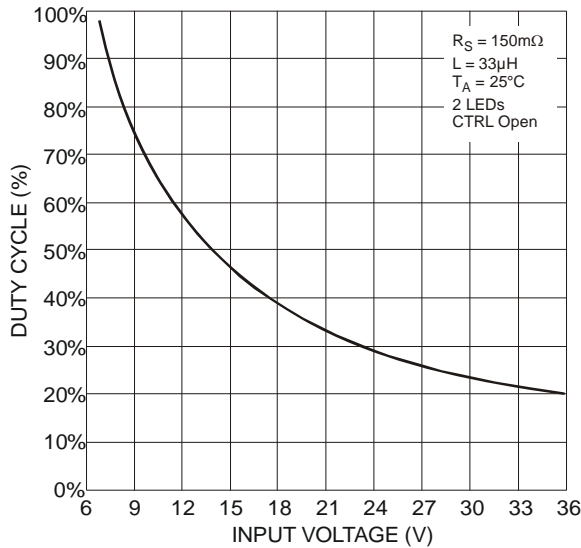

Figure 13 Duty Cycle vs. Input Voltage

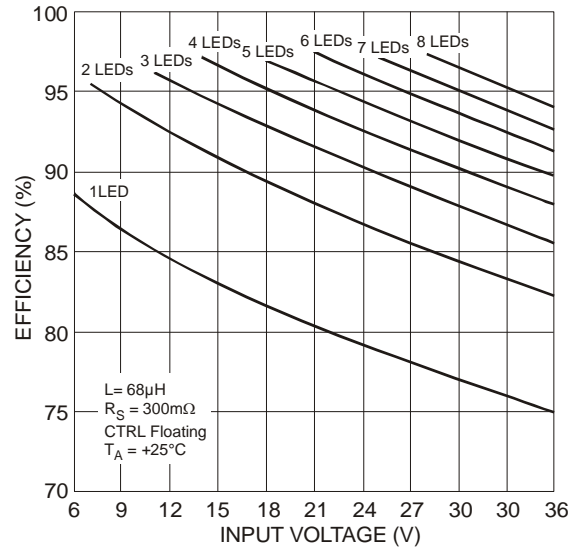

Figure 14 Efficiency vs. Input Voltage

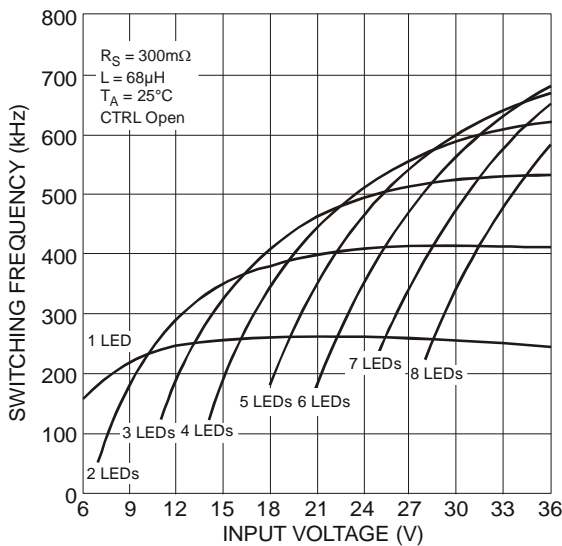

Figure 15 Switching Frequency vs. Input Voltage

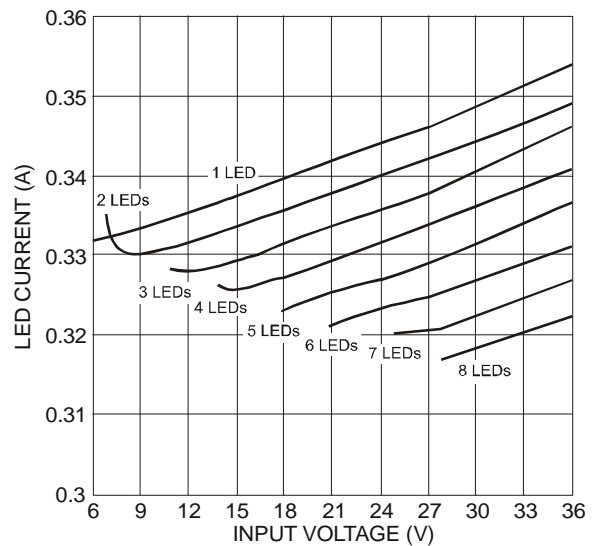

Figure 16 330mA LED Current vs. Input Voltage

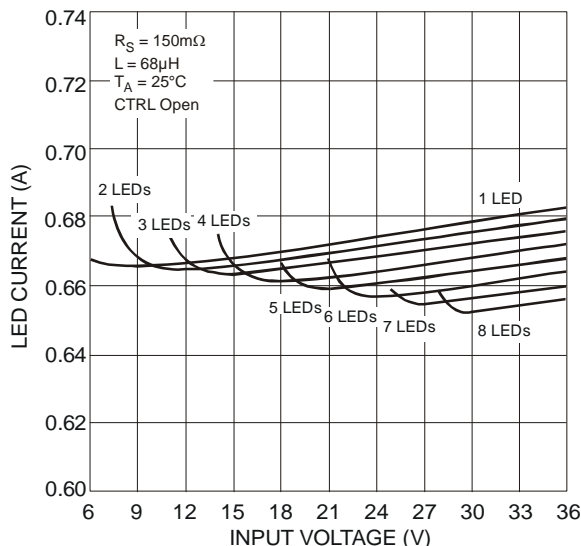

Figure 17 670mA LED Current vs. Input Voltage

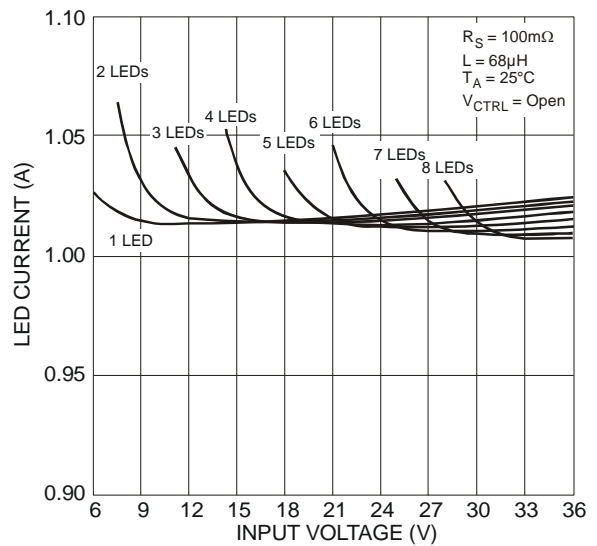

Figure 18 1A LED Current vs. Input Voltage

Typical Performance Characteristics (670mA LED Current) (@ $T_A = +25^\circ\text{C}$, unless otherwise specified.)

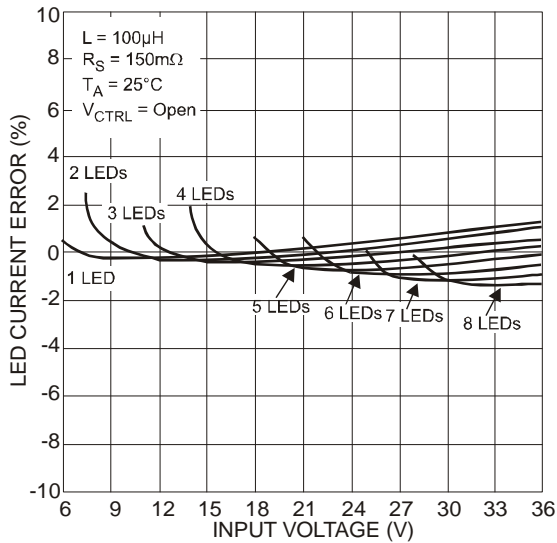

Figure 19 LED Current Deviation vs. Input Voltage

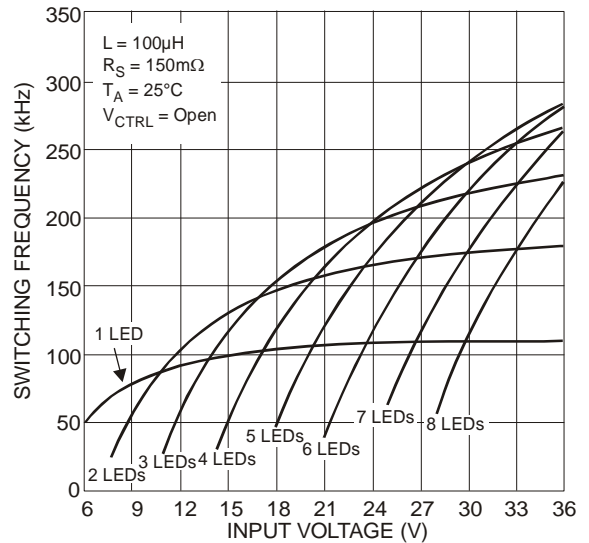

Figure 20 Switching Frequency vs. Input Voltage

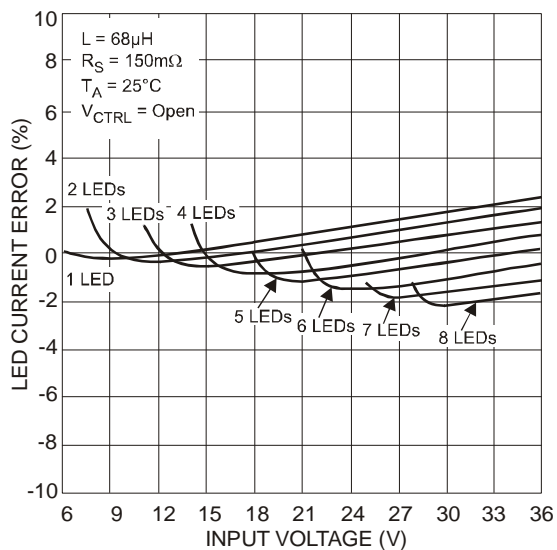

Figure 21 LED Current Deviation vs. Input Voltage

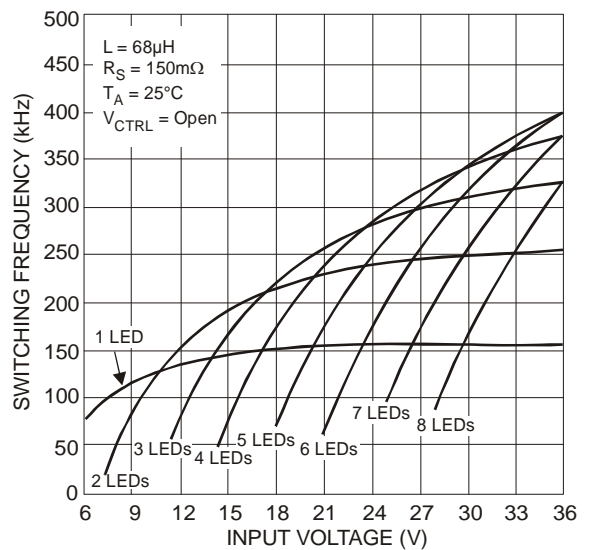

Figure 22 Switching Frequency vs. Input Voltage

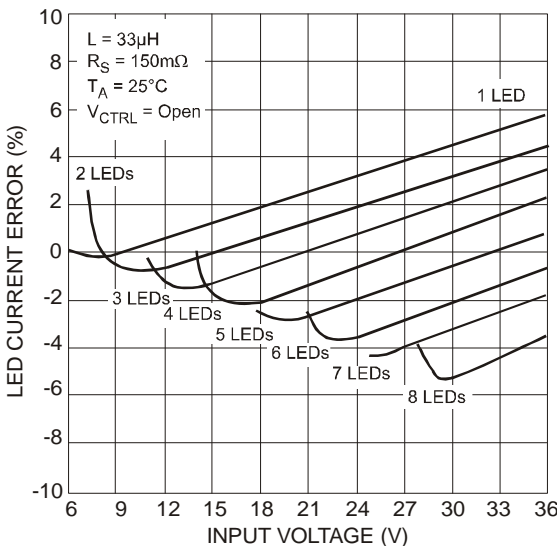

Figure 23 LED Current Deviation vs. Input Voltage

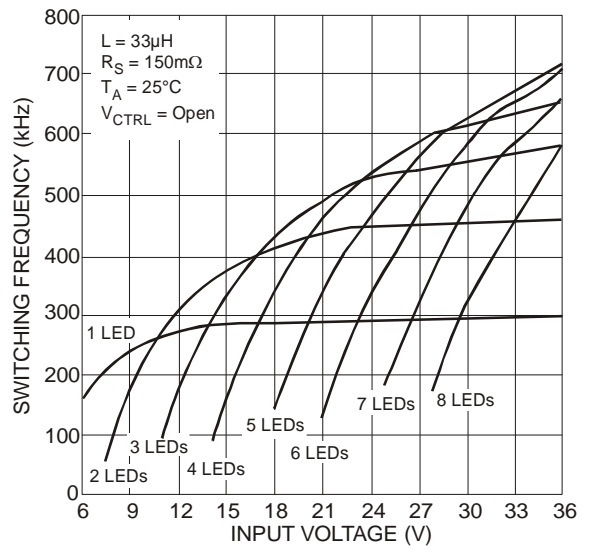

Figure 24 Switching Frequency vs. Input Voltage

Typical Performance Characteristics (1A LED Current) (@ $T_A = +25^\circ\text{C}$, unless otherwise specified.)

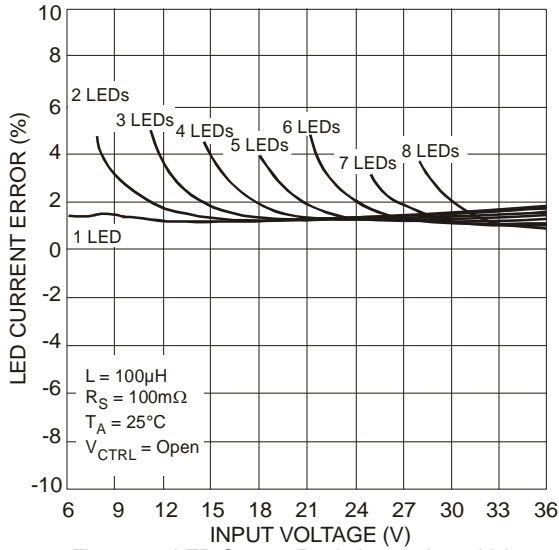

Figure 25 LED Current Deviation vs. Input Voltage

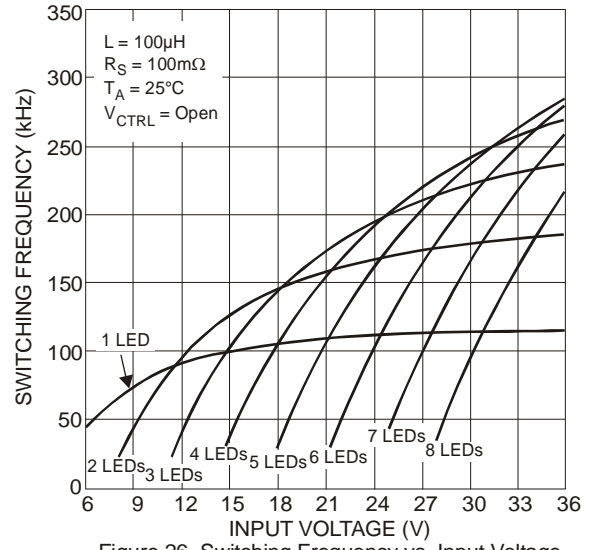

Figure 26 Switching Frequency vs. Input Voltage

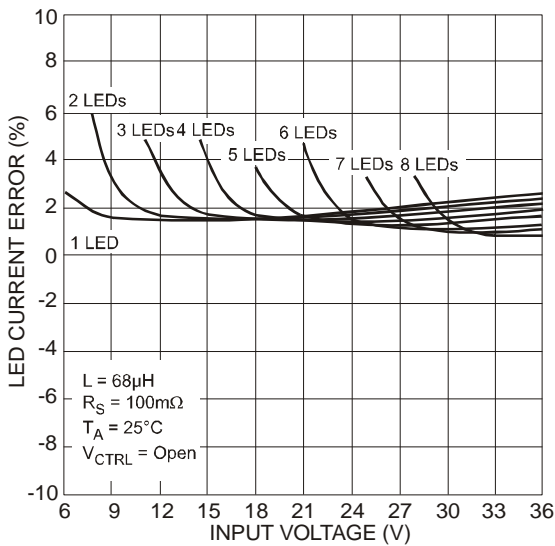

Figure 27 LED Current Deviation vs. Input Voltage

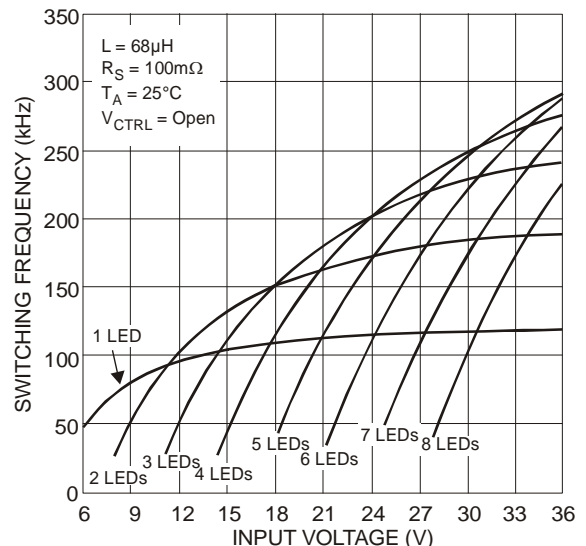

Figure 28 Switching Frequency vs. Input Voltage

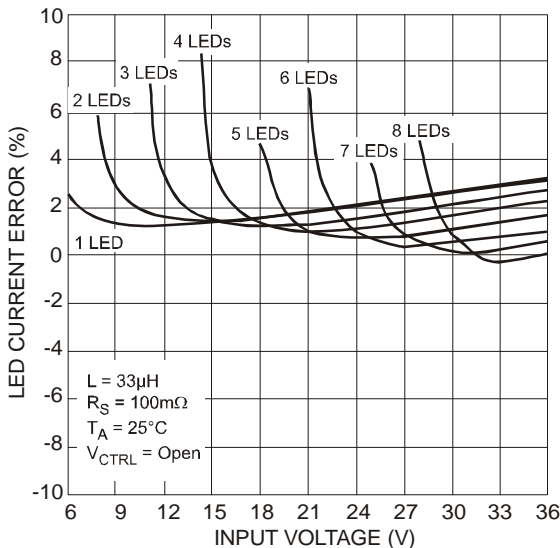

Figure 29 LED Current Deviation vs. Input Voltage

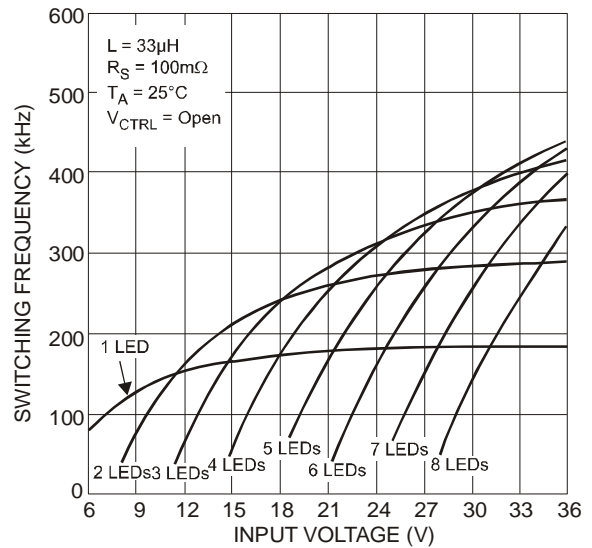

Figure 30. Switching Frequency vs. Input Voltage

Application Information

AL8807A Operation

The AL8807A is a hysteretic LED current switching regulator sometimes known as an equal ripple switching regulator. In normal operation, when voltage is applied at +V_{IN} (See Figure 31), the AL8807A internal switch is turned on. Current starts to flow through sense resistor R₁, inductor L1, and the LEDs. The current ramps up linearly, and the ramp rate is determined by the input voltage +V_{IN}, and the inductor L1 (See Figure 32).

This rising current produces a voltage ramp across R₁. The internal circuit of the AL8807A senses the voltage across R₁ and applies a proportional voltage to the input of the internal comparator.

When this voltage reaches an internally set upper threshold, the internal switch is turned off. The inductor current continues to flow through R₁, L1, the LEDs and the schottky diode D1, and back to the supply rail, but it decays, with the rate of decay determined by the forward voltage drop of the LEDs and the schottky diode.

This decaying current produces a falling voltage at R₁, which is sensed by the AL8807A. A voltage proportional to the sense voltage across R₁ is applied at the input of the internal comparator. When this voltage falls to the internally set lower threshold, the internal switch is turned on again. This switch-on-and-off cycle continues to provide the average LED current set by the sense resistor R₁, with a switching current determined by the input voltage and LED chain voltage.

In normal operation the off time is relatively constant (determined mainly by the LED chain voltage) with only the on-time varying as the input voltage changes. At duty cycles up to around 80% the ramp of the LED/switch current is very linear; however, as the duty cycle approaches 95% the LED current ramp starts to become more exponential. This has two effects:

1. The overall on time starts to increase lowering the overall switching frequency.
2. The average LED current starts to increase – which may impact accuracy.

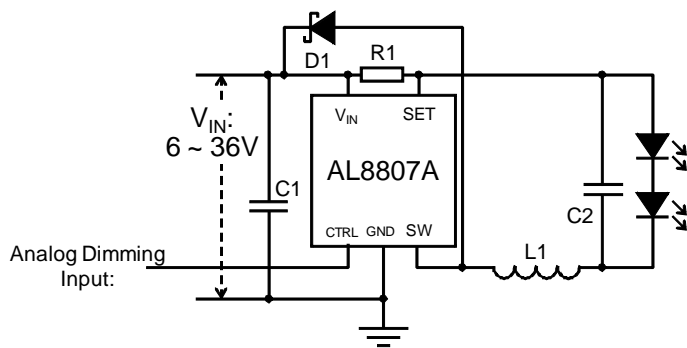

Figure 31 Typical Application Circuit

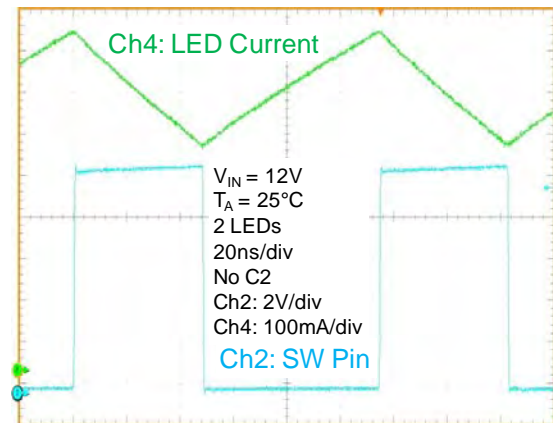

Figure 32 Typical Operating Waveform (C2 not fitted)

LED Current Control

With the CTRL pin open circuit, the LED current is determined by the resistor, R₁, (see Figure 31), connected between V_{IN} and SET. The nominal average output current in the LED(s) is defined as:

$$I_{LED} = \frac{V_{TH}}{R1} \quad \text{where } V_{TH} \text{ is nominally } 100\text{mV}$$

For example for a desired LED current of 660mA the resulting resistor is:

$$R1 = \frac{V_{TH}}{I_{LED}} = \frac{0.1}{0.66} \approx 150\text{m}\Omega$$

Application Information (cont.)

Analog Dimming

Further control of the LED current can be achieved by driving the CTRL pin with an external voltage lower than 2.5V; the average LED current becomes:

$$I_{LED} = \frac{V_{CTRL}}{V_{REF}} \frac{V_{TH}}{R_{SET}}$$

Where V_{REF} is nominally 2.5V

The LED current decreases linearly with the CTRL voltage when $V_{CTRL} \leq 2.5V$, as in Figure 9 for 2 different current levels.

Note that 100% brightness setting corresponds to $V_{CTRL} = V_{REF}$, nominally 2.5V.

If a voltage greater than 2.6V is applied to the CTRL pin an internal clamp is activated which results in the internal reference voltage being applied to the hysteresis control circuitry. This prevents the LED current from being overdriven and will still set the LED current to approximately.

$$I_{LED} = \frac{V_{TH}}{R_{SET}}$$

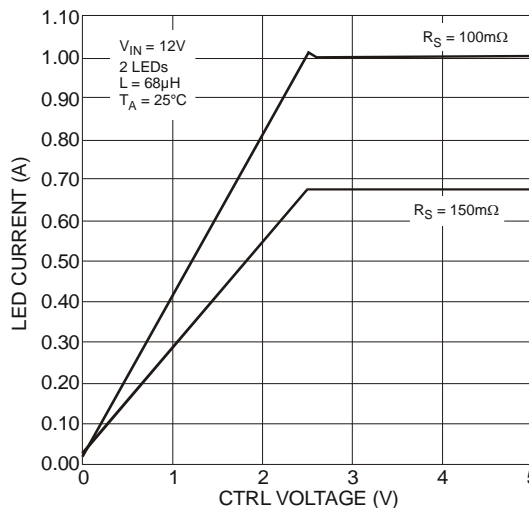

Figure 33 LED Current vs. CTRL Pin Voltage

As the CTRL pin is reduced below 2.5V the sense voltage will proportionally decrease. This means that the time taken for the LED/Switch current to ramp up to the upper threshold will decrease. The AL8807A, being a hysteretic converter, automatically compensates for the reduction in LED current by reducing its lower threshold voltage and therefore its off-time. It therefore remains in continuous conduction mode maintaining a better dimming accuracy than other peak-switch current control topologies.

A result of the reduced on- and off-times results in an increase of the switching frequency. This phenomenon can be seen in Figure 34.

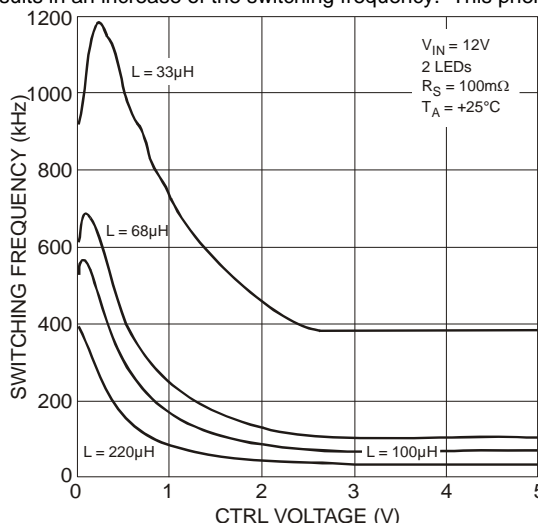

Figure 34 Switching Frequency vs. V_{CTRL}

Ultimately at very small CTRL pin voltages the AL8807A will switch much faster than its nominal switching frequency which due to propagation delays leads to a non-linear degrading of accuracy.

The degradation in linear dimming accuracy at small CTRL pin voltages can be improved by using larger value inductors which cause the AL8807A to oscillate at lower frequencies.

A further cause of loss of linearity as small CTRL pin voltages is the internal offsets of the control loop; at a CTRL pin voltage of 0.25V the nominal LED current sense voltage has been reduced to 10mV.

Application Information (cont.)

Soft Start

The AL8807A does not have in-built soft-start action; this can be seen in Figure 35.

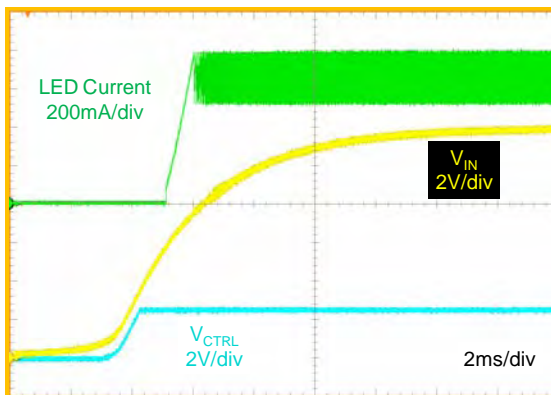

Figure 35 Start up without any capacitor on CTRL Pin ($V_{IN} = 12V$, $I_{LED} = 667mA$, 2 LEDs)

At power-up V_{IN} rises exponentially, due to the bulk capacitor, the internal reference will reach 2.5V before V_{IN} reaches the Under-Voltage Lock-Out turn-on threshold at around 5.6V. This causes the CTRL pin voltage to rise and reaches 2.5V – 100% LED current - before the AL8807A fully turns on. When the AL8807A turns on, its output switch turns causing the inductor current to increase until it reaches the upper threshold of the sense current level and the switching process begins.

Adding an external capacitor from the CTRL pin to ground will provide a soft-start delay (see Figures 36 and 37).

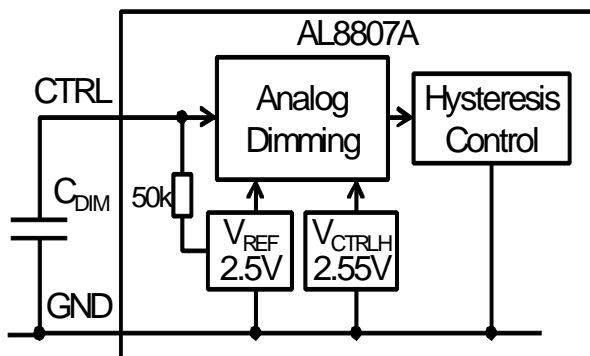

Figure 36 Soft Start

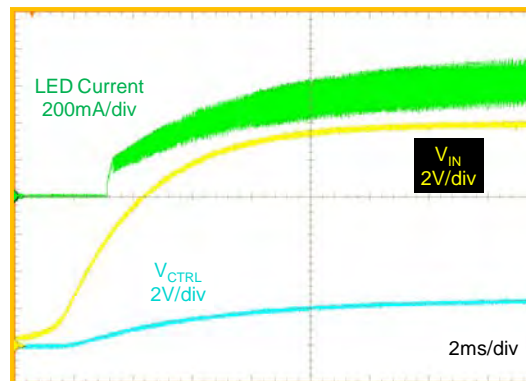

Figure 37 Soft Start with 100nF Capacitor on CTRL Pin

Adding a capacitor to the CTRL pin provides a soft-start by increasing the time taken for the CTRL voltage to rise to 2.5V and by slowing down the rate of rise of the control voltage at the input of the comparator in the hysteresis control block (refer to Figure 36). This capacitor has 2 effects:

1. It reduces the minimum start-up current. The bigger the capacitor the lower the CTRL pin voltage will be when UVLO level is exceeded and the output switch turns on..
2. The rate at which the inductor/LED current is ramped up is dependent on the size of the capacitor.

As can be seen in Figure 37 adding a capacitor increases the time taken for the output to reach 90% of its final value.

There are many factors which set the initial current and ramp rate. Some practical examples are shown below with conditions $V_{in} 12V$ $L=68\mu H$ 2 LEDs at 667mA,

C_{DIM}	Initial Current 90%	Rise Time
0nF	80mA	0.45ms
10nF	80mA	0.55ms
22nF	80mA	0.8ms
47nF	80mA	1.8ms
100nF	80mA	4.2ms
470nF	40mA	42ms

Application Information (cont.)

Input Bulk Capacitor Selection

The small size of ceramic capacitors makes them ideal for AL8807A applications. X5R and X7R types are recommended because they retain their capacitance over wider voltage and temperature ranges than other types such as Z5U.

A 2.2µF input capacitor is sufficient for most intended applications of AL8807A; however a 4.7µF input capacitor is suggested for input voltages approaching 36V.

Diode Selection

For maximum efficiency and performance, the rectifier (D1) should be a fast low capacitance Schottky diode with low reverse leakage at the maximum operating voltage and temperature. The Schottky diode also provides better efficiency than silicon PN diodes, due to a combination of lower forward voltage and reduced recovery time.

It is important to select parts with a peak current rating above the peak coil current and a continuous current rating higher than the maximum output load current. In particular, it is recommended to have a diode voltage rating at least 15% higher than the operating voltage to ensure safe operation during the switching and a current rating at least 10% higher than the average diode current. The power rating is verified by calculating the power loss through the diode.

Schottky diodes, e.g. B240 or B140, with their low forward voltage drop and fast reverse recovery, are the ideal choice for AL8807A applications.

Inductor Selection

Recommended inductor values for the AL8807A are in the range 33µH to 100µH.

Higher values of inductance are recommended at higher supply voltages as they result in lower switching frequencies which in turn reduce the errors due to switching delays. Higher values of inductance also result in a smaller change in output current over the supply voltage range. (See graphs).

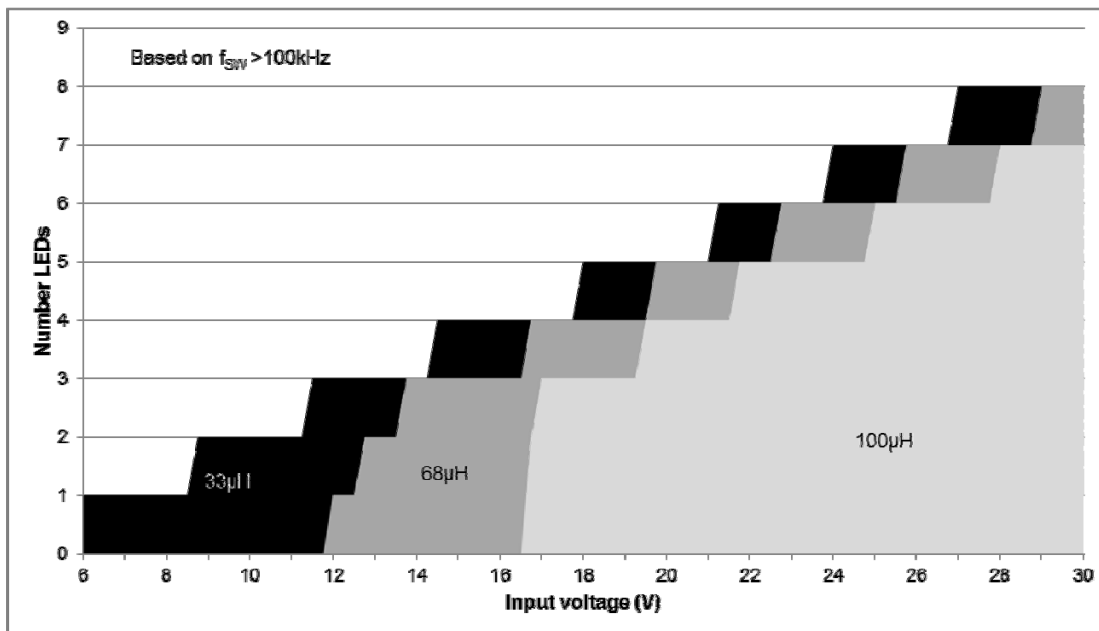

Figure 38 Inductor Value with Input Voltage and Number of LEDs

The inductor should be mounted as close to the device as possible with low resistance/stray inductance connections to the SW pin.

The chosen coil should have a saturation current higher than the peak output current and a continuous current rating above the required mean output current.

Suitable coils for use with the AL8807A are listed in the table below:

Part No.	L (µH)	DCR (V)	ISAT (A)	Manufacturer
MSS1038-333	33	0.093	2.3	CoilCraft www.coilcraft.com
MSS1038-683	68	0.213	1.5	
NPIS64D330MTRF	33	0.124	1.1	NIC www.niccomp.com

Application Information (cont.)

The inductor value should be chosen to maintain operating duty cycle and switch 'on/off' times over the supply voltage and load current range. The following equations can be used as a guide, with reference to Figure 39 – typical switching waveform.

Switch 'On' time

$$t_{ON} = \frac{L\Delta I}{V_{IN} - V_{LED} - I_{AVG} \times (R_S + r_L + R_{SW})}$$

Switch 'Off' time

$$t_{OFF} = \frac{L\Delta I}{V_{LED} + V_D + I_{AVG} \times (R_S + r_L)}$$

Where:

- L is the coil inductance (H)
- r_L is the coil resistance (Ω)
- R_S is the current sense resistance (Ω)
- I_{avg} is the required LED current (A)
- ΔI is the coil peak-peak ripple current (A)
{Internally set to 0.3 x I_{avg}}
- V_{IN} is the supply voltage (V)
- V_{LED} is the total LED forward voltage (V)
- R_{SW} is the switch resistance (Ω) {= 0.25Ω nominal (SOT25)}
- V_D is the diode forward voltage at the required load current (V)

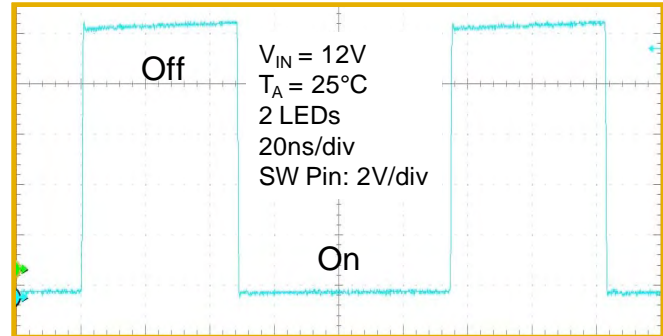

Figure 39 Typical Switching Waveform

Thermal Considerations

For continuous conduction mode of operation, the absolute maximum junction temperature must not be exceeded. The maximum power dissipation depends on several factors: the thermal resistance of the IC package θ_{JA}, PCB layout, airflow surrounding the IC, and difference between junction and ambient temperature.

The maximum power dissipation can be calculated using the following formula:

$$P_{D(MAX)} = (T_{J(MAX)} - T_A) / \theta_{JA}$$

where

- T_{J(MAX)} is the maximum operating junction temperature,
- T_A is the ambient temperature,
- θ_{JA} is the junction to ambient thermal resistance.

The recommended maximum operating junction temperature, T_J, is +125°C and so maximum ambient temperature is determined by the AL8807A's junction to ambient thermal resistance, θ_{JA} and device power dissipation.

θ_{JA}, is layout dependent and package dependent; the AL8807AW5's θ_{JA} on a 25 x 25mm single layer PCB with 1oz copper standing in still air is approximately +250°C/W and around 130°C/W on a 51mm x 51mm dual layer board with maximum coverage top and bottom and 3 vias.

The maximum power dissipation at T_A = +25°C can be calculated by the following formulas:

$$P_{D(MAX)} = (+125°C - +25°C) / (250°C/W) = 0.4W \text{ for single-layer 25mm x 25mm PCB}$$

$$P_{D(MAX)} = (+125°C - +25°C) / (130°C/W) = 0.77W \text{ for dual layer 51mm x 51mm PCB}$$

Figure 40, shows the power derating of the AL8807AW5 on two different PCBs and the AL8807AMP on one PCB.

- SOT25 – 25mm x 25mm: AL8807AW5's θ_{JA} on a 25 x 25mm single layer PCB with 1oz copper
- SOT25 – 25mm x 25mm: AL8807AW5's θ_{JA} on a 51mm x 51mm dual layer board with maximum coverage top and bottom and 3 vias
- MSOP-8EP - 51mm x 51mm: AL8807AMP's θ_{JA} on a 51mm x 51mm dual layer board with maximum coverage top and bottom and 4 vias

Figure 40 shows that the MSOP-8EP version of the AL8807A can handle more power than its SOT25 version. So the AL8807AMP is the preferred variant when operating at larger supply voltage rails (>24V) and/or driving larger LED currents. This is especially true in high power density/space constraint applications such as high power 24VAC MR16 applications.

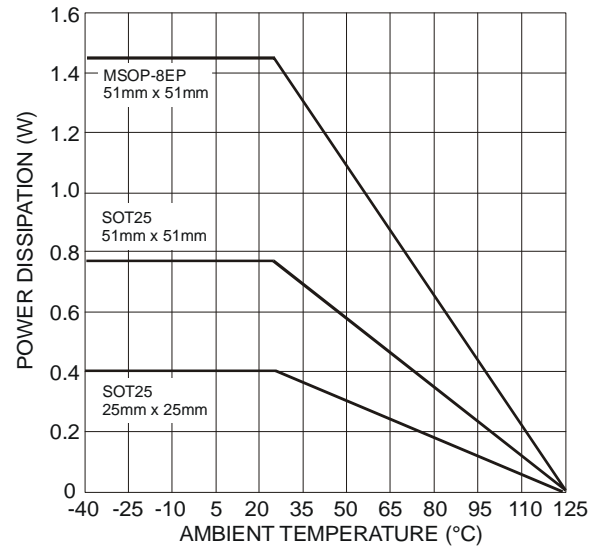

Figure 40 Derating Curve for Different PCB

Application Information (cont.)

EMI and Layout Considerations

The AL8807A is a switching regulator with fast edges and measures small differential voltages; as a result of this care has to be taken with decoupling and layout of the PCB. To help with these effects the AL8807A has been developed to minimise radiated emissions by controlling the switching speeds of the internal power MOSFET.

The rise and fall times are controlled to get the right compromise between power dissipation due to switching losses and radiated EMI. The turn-on edge (falling edge) dominates the radiated EMI which is due to an interaction between the Schottky diode (D1), Switching MOSFET and PCB tracks. After the Schottky diode reverse recovery time of around 5ns has occurred; the falling edge of the SW pin sees a resonant loop between the Schottky diode capacitance and the track inductance, L_{TRACK} . See Figure 41.

The tracks from the SW pin to the Anode of the Schottky diode, D1, and then from D1's cathode to the decoupling capacitors C1 should be as short as possible.

There is an inductance internally in the AL8807A this can be assumed to be around 1nH. For PCB tracks a figure of 0.5nH per mm can be used to estimate the primary resonant frequency. If the track is capable of handling 1A increasing the thickness will have a minor effect on the inductance and length will dominate the size of the inductance.

The resonant frequency of any oscillation is determined by the combined inductance in the track and the effective capacitance of the Schottky diode.

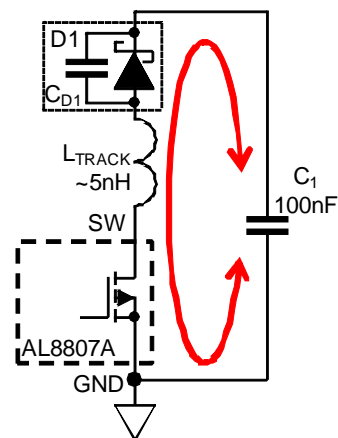

Figure 41 PCB Loop Resonance

An example of good layout is shown in Figure 42 - the stray track inductance should be less than 5nH.

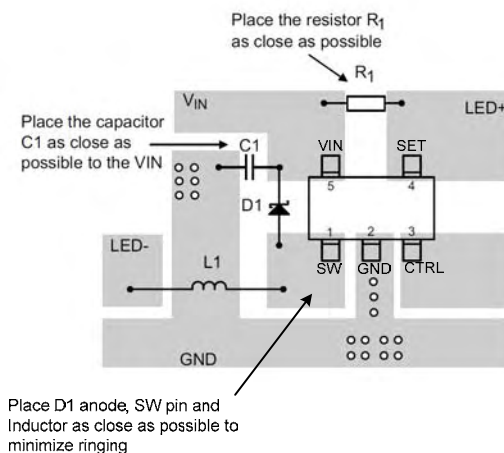

Figure 42 Recommended PCB Layout

Recommendations for minimising radiated EMI and other transients and thermal considerations are:

1. The decoupling capacitor (C1) has to be placed as close as possible to the V_{IN} pin and D1 Cathode.
2. The freewheeling diode's (D1) anode, the SW pin and the inductor have to be placed as close as possible to avoid ringing.
3. The Ground return path from C1 must be a low impedance path with the ground plane as large as possible.
4. The LED current sense resistor (R1) has to be placed as close as possible to the V_{IN} and SET pins.
5. The majority of the conducted heat from the AL8807A is through the GND pin 2. A maximum earth plane with thermal vias into a second earth plane will minimise self-heating.
6. To reduce emissions via long leads on the supply input and LEDs low RF impedance capacitors (C2 and C5) should be used at the point the wires are joined to the PCB.

Application Information (cont.)

Fault Condition Operation

Open circuit LEDs

The AL8807A has by default open LED protection. If the LEDs should become open circuit the AL8807A will stop oscillating; the SET pin will rise to V_{IN} and the SW pin will then fall to GND. No excessive voltages will be seen by the AL8807A.

LED Chain Shorted Together

If the LED chain should become shorted together (the anode of the top LED becomes shorted to the cathode of the bottom LED) the AL8807A will continue to switch and the current through the AL8807A's internal switch will still be at the expected current - so no excessive heat will be generated within the AL8807A. However, the duty cycle at which it operates will change dramatically and the switching frequency will most likely decrease. See Figure 43 for an example of this behavior at 24V input voltage driving 3 LEDs.

The on-time of the internal power MOSFET switch is significantly reduced because almost all of the input voltage is now developed across the inductor. The off-time is significantly increased because the reverse voltage across the inductor is now just the Schottky diode voltage (See Figure 43) causing a much slower decay in inductor current.

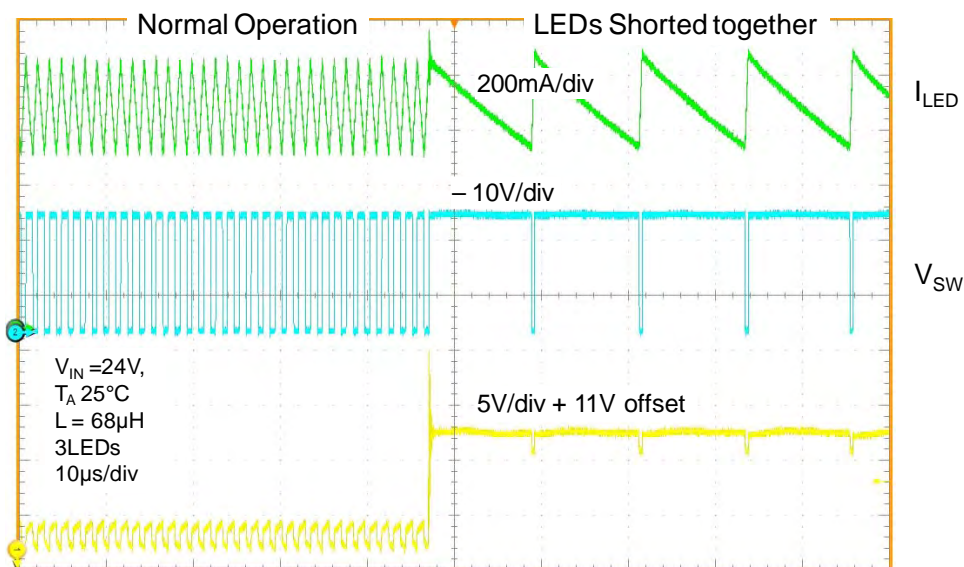

Figure 43 Switching Characteristics (normal operation to LED chain shorted out)

High Temperature Operation and Protection

The AL8807A is a high efficiency switching LED driver capable of operating junction temperatures up to +125°C. This allows it operate with ambient temperature in excess of 100°C given the correct thermal impedance to free air. If a fault should occur that leads to increased ambient temperatures and hence junction temperature then the Over-Temperature Protection (OTP) of the AL8807A will cut in turning the output of the AL8807A off. This will allow the junction temperature of the AL8807A to cool down and potentially giving an opportunity for the fault to clear itself.

The OTP shutdown junction temperature of the AL8807A is approximately +150°C with a hysteresis of +25°C. This means that the AL8807A will never switch-off with a junction temperature below +125°C allowing the designer to design the system thermally to fully utilize the wide operating junction temperature of the AL8807A.

Ordering Information

AL8807A XX - XX

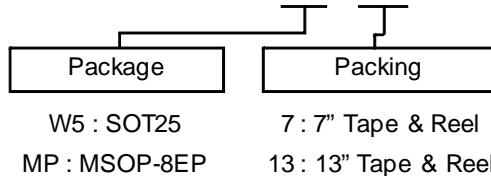

Part Number	Status	Package Code	Packaging	7" Tape and Reel	
				Quantity	Part Number Suffix
AL8807AW5-7	Preview (Note 11)	W5	SOT25	3000/Tape & Reel	-7
AL8807AMP-13	New Product	MP	MSOP-8EP	2500/Tape & Reel	-13

Note: 11. Expected release in 4Q 2012.

Marking Information

(1) SOT25

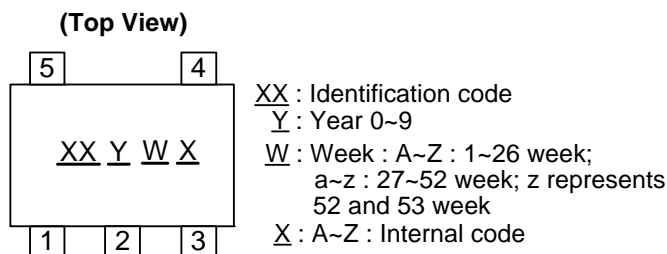

Part Number	Package	Identification Code
AL8807AW5-7	SOT25	C6

(2) MSOP-8EP

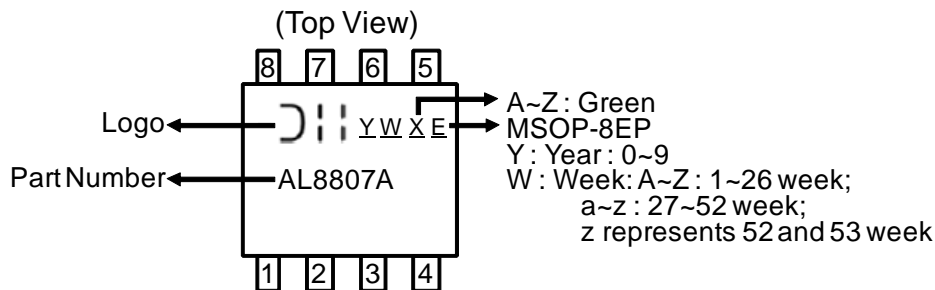

Part Number	Package
AL8807AMP-13	MSOP-8EP

Package Outline Dimensions (All dimensions in mm.)

Please see AP02002 at <http://www.diodes.com/datasheets/ap02002.pdf> for latest version.

(1) SOT25

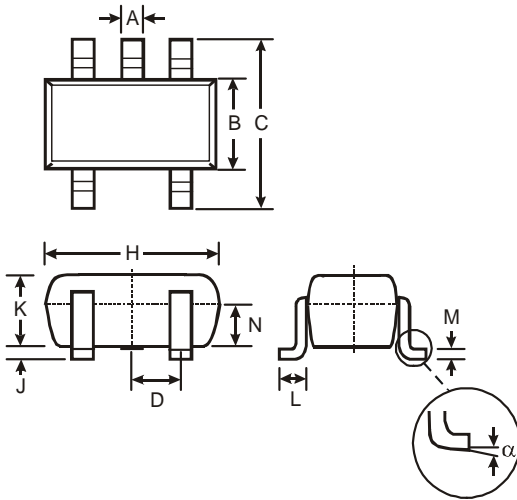

SOT25			
Dim	Min	Max	Typ
A	0.35	0.50	0.38
B	1.50	1.70	1.60
C	2.70	3.00	2.80
D	—	—	0.95
H	2.90	3.10	3.00
J	0.013	0.10	0.05
K	1.00	1.30	1.10
L	0.35	0.55	0.40
M	0.10	0.20	0.15
N	0.70	0.80	0.75
α	0°	8°	—
All Dimensions in mm			

(2) MSOP-8EP

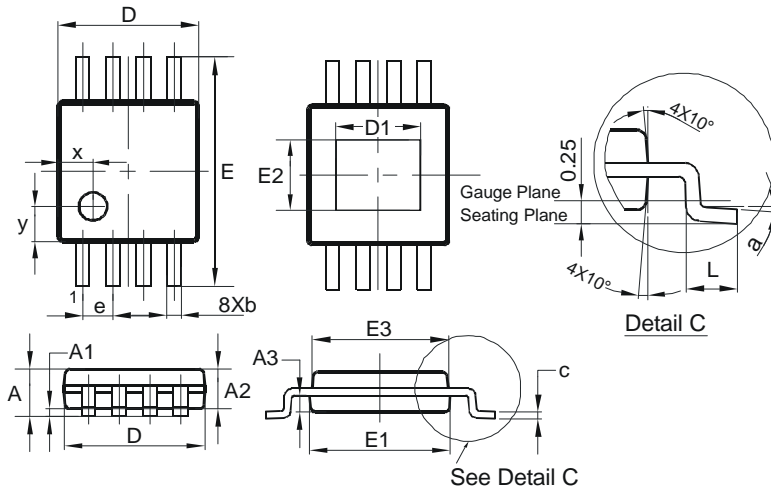

MSOP-8EP			
Dim	Min	Max	Typ
A	-	1.10	-
A1	0.05	0.15	0.10
A2	0.75	0.95	0.86
A3	0.29	0.49	0.39
b	0.22	0.38	0.30
c	0.08	0.23	0.15
D	2.90	3.10	3.00
D1	1.60	2.00	1.80
E	4.70	5.10	4.90
E1	2.90	3.10	3.00
E2	1.30	1.70	1.50
E3	2.85	3.05	2.95
e	-	-	0.65
L	0.40	0.80	0.60
a	0°	8°	4°
x	-	-	0.750
y	-	-	0.750
All Dimensions in mm			

Suggested Pad Layout

Please see AP02001 at <http://www.diodes.com/datasheets/ap02001.pdf> for latest version.

(1) SOT25

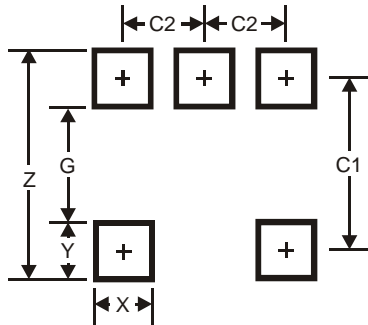

Dimensions	Value (in mm)
Z	3.20
G	1.60
X	0.55
Y	0.80
C1	2.40
C2	0.95

(2) MSOP-8EP

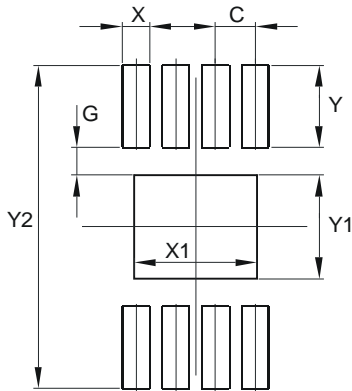

Dimensions	Value (in mm)
C	0.650
G	0.450
X	0.450
X1	2.000
Y	1.350
Y1	1.700
Y2	5.300

IMPORTANT NOTICE

DIODES INCORPORATED MAKES NO WARRANTY OF ANY KIND, EXPRESS OR IMPLIED, WITH REGARDS TO THIS DOCUMENT, INCLUDING, BUT NOT LIMITED TO, THE IMPLIED WARRANTIES OF MERCHANTABILITY AND FITNESS FOR A PARTICULAR PURPOSE (AND THEIR EQUIVALENTS UNDER THE LAWS OF ANY JURISDICTION).

Diodes Incorporated and its subsidiaries reserve the right to make modifications, enhancements, improvements, corrections or other changes without further notice to this document and any product described herein. Diodes Incorporated does not assume any liability arising out of the application or use of this document or any product described herein; neither does Diodes Incorporated convey any license under its patent or trademark rights, nor the rights of others. Any Customer or user of this document or products described herein in such applications shall assume all risks of such use and will agree to hold Diodes Incorporated and all the companies whose products are represented on Diodes Incorporated website, harmless against all damages.

Diodes Incorporated does not warrant or accept any liability whatsoever in respect of any products purchased through unauthorized sales channel. Should Customers purchase or use Diodes Incorporated products for any unintended or unauthorized application, Customers shall indemnify and hold Diodes Incorporated and its representatives harmless against all claims, damages, expenses, and attorney fees arising out of, directly or indirectly, any claim of personal injury or death associated with such unintended or unauthorized application.

Products described herein may be covered by one or more United States, international or foreign patents pending. Product names and markings noted herein may also be covered by one or more United States, international or foreign trademarks.

LIFE SUPPORT

Diodes Incorporated products are specifically not authorized for use as critical components in life support devices or systems without the express written approval of the Chief Executive Officer of Diodes Incorporated. As used herein:

A. Life support devices or systems are devices or systems which:

1. are intended to implant into the body, or
2. support or sustain life and whose failure to perform when properly used in accordance with instructions for use provided in the labeling can be reasonably expected to result in significant injury to the user.

B. A critical component is any component in a life support device or system whose failure to perform can be reasonably expected to cause the failure of the life support device or to affect its safety or effectiveness.

Customers represent that they have all necessary expertise in the safety and regulatory ramifications of their life support devices or systems, and acknowledge and agree that they are solely responsible for all legal, regulatory and safety-related requirements concerning their products and any use of Diodes Incorporated products in such safety-critical, life support devices or systems, notwithstanding any devices- or systems-related information or support that may be provided by Diodes Incorporated. Further, Customers must fully indemnify Diodes Incorporated and its representatives against any damages arising out of the use of Diodes Incorporated products in such safety-critical, life support devices or systems.

Copyright © 2012, Diodes Incorporated

www.diodes.com

Данный компонент на территории Российской Федерации

Вы можете приобрести в компании MosChip.

Для оперативного оформления запроса Вам необходимо перейти по данной ссылке:

<http://moschip.ru/get-element>

Вы можете разместить у нас заказ для любого Вашего проекта, будь то серийное производство или разработка единичного прибора.

В нашем ассортименте представлены ведущие мировые производители активных и пассивных электронных компонентов.

Нашей специализацией является поставка электронной компонентной базы двойного назначения, продукции таких производителей как XILINX, Intel (ex.ALTERA), Vicor, Microchip, Texas Instruments, Analog Devices, Mini-Circuits, Amphenol, Glenair.

Сотрудничество с глобальными дистрибьюторами электронных компонентов, предоставляет возможность заказывать и получать с международных складов практически любой перечень компонентов в оптимальные для Вас сроки.

На всех этапах разработки и производства наши партнеры могут получить квалифицированную поддержку опытных инженеров.

Система менеджмента качества компании отвечает требованиям в соответствии с ГОСТ Р ИСО 9001, ГОСТ РВ 0015-002 и ЭС РД 009

Офис по работе с юридическими лицами:

105318, г.Москва, ул.Щербаковская д.3, офис 1107, 1118, ДЦ «Щербаковский»

Телефон: +7 495 668-12-70 (многоканальный)

Факс: +7 495 668-12-70 (доб.304)

E-mail: info@moschip.ru

Skype отдела продаж:

moschip.ru

moschip.ru_4

moschip.ru_6

moschip.ru_9