

PART NUMBER	CCL-LX45YT	REV.	I
DATE	E.C.N. NUMBER AND REVISION COMMENTS		REV.
11.20.95	ADDED TAPE AND REEL SPEC.		A
12.18.95	E.C.N. #10105.		B
04.08.96	E.C.N. #10143.		C
05.30.96	E.C.N. #10176.		D
11.09.98	E.C.N. #10BRDR. & REDRAWN.		E
04.28.99	E.C.N. #10511./ADDED SOLDER CHART.		F
06.17.99	E.C.N. #10524./CHANGED HEIGHT.		G
12.04.06	E.C.N. #11148.		H
04.12.11	E.C.N. #10BRDR. & REDRAWN.		I

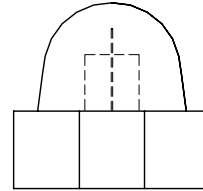
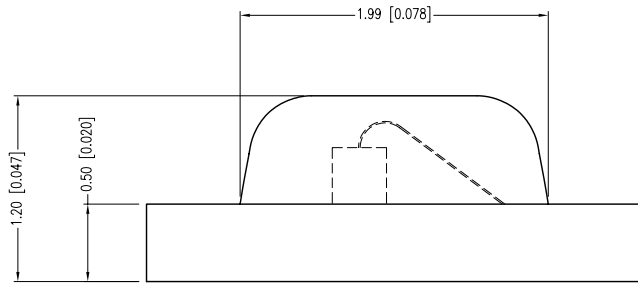
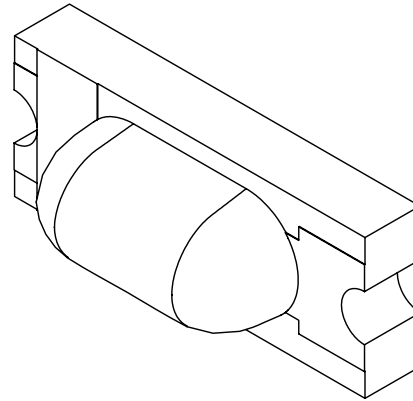
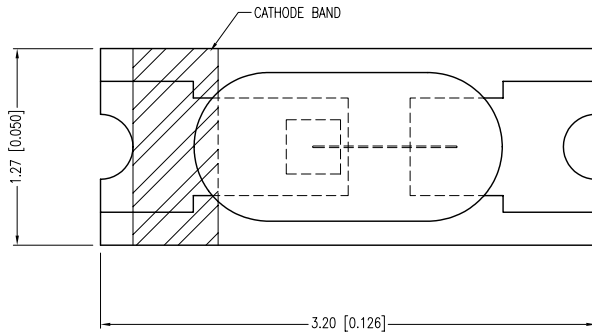

ELECTRO-OPTICAL CHARACTERISTICS TA =25°C If=20mA

PARAMETER	MIN	TYP.	MAX	UNITS	TEST COND
PEAK WAVELENGTH		585		nm	
FORWARD VOLTAGE		2.3	2.5	Vf	
REVERSE VOLTAGE	5.0			Vr	Ir=100µA
AXIAL INTENSITY		7.0		mcd	If=20mA
VIEWING ANGLE		180		2x theta	
EMITTED COLOR:	YELLOW				
EPOXY LENS FINISH:	YELLOW TRANSPARENT				

LIMITS OF SAFE OPERATION AT 25°C

PARAMETER	MAX	UNITS
PEAK FORWARD CURRENT*	800	mA
STEADY CURRENT	30	mA
POWER DISSIPATION	130	mW
DERATE FROM 25°C	-2.4	mW/°C
OPERATING TEMP.	-30 TO +80	°C
STORAGE TEMP.	-40 TO +120	°C

\* t<10µs

RECOMMENDED SOLDER PAD LAYOUT

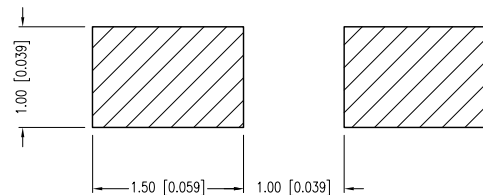

\*UNLESS OTHERWISE SPECIFIED TOLERANCES PER DECIMAL PRECISION ARE: X=±1 (±0.039), X.X=±0.5 (±0.020), X.XX=±0.25 (±0.010), X.XXX=±0.127 (±0.005). LEAD SIZE=±0.05 (±0.002), LEAD LENGTH=±0.75 (±0.030). MIN.= +<sup>DECIMAL</sup>PRECISION MAX.= +<sup>0.00</sup>/<sub>-0.00</sub>DECIMAL PRECISION

**LUMEX**  
 Creating LED and LCD Solutions Together.™  
 290 E. HELEN ROAD  
 PALATINE, IL 60067-6976  
 PHONE: +1.847.359.2790  
 FAX: +1.847.359.6538  
 WEB: WWW.LUMEX.COM

CERAMIC CHIP, SURFACE, MOUNT LED, YELLOW TRANSPARENT, TAPE AND REEL.

\*\*THE SPECIFICATIONS MAY CHANGE AT ANY TIME WITHOUT NOTICE DUE TO NEW MATERIALS OR PRODUCT IMPROVEMENT.\*\*

CONFIDENTIAL INFORMATION  
 THE INFORMATION CONTAINED IN THIS DOCUMENT IS THE PROPERTY OF LUMEX INC. EXCEPT AS SPECIFICALLY AUTHORIZED IN WRITING BY LUMEX INC., THE HOLDER OF THIS DOCUMENT SHALL KEEP ALL INFORMATION CONTAINED HEREIN CONFIDENTIAL AND SHALL PROTECT SAME IN WHOLE OR IN PART FROM DISCLOSURE AND DISSEMINATION TO ALL THIRD PARTIES.

DATE:	04.12.11	DRAWN BY:	AB
PAGE:	1 OF 2	CHKD BY:	SS
SCALE:	NTS	APRVD BY:	JD
UNIT:	mm [INCH]		Ⓟ

PART NUMBER	CCL-LX45YT	REV.	I
DATE	E.C.N. NUMBER AND REVISION COMMENTS		REV.
11.20.95	ADDED TAPE AND REEL SPEC.		A
12.18.95	E.C.N. #10105.		B
04.08.96	E.C.N. #10143.		C
05.30.96	E.C.N. #10176.		D
11.09.98	E.C.N. #10BRDR. & REDRAWN.		E
04.28.99	E.C.N. #10511./ADDED SOLDER CHART.		F
06.17.99	E.C.N. #10524./CHANGED HEIGHT.		G
12.04.06	E.C.N. #11148.		H
04.12.11	E.C.N. #10BRDR. & REDRAWN.		I

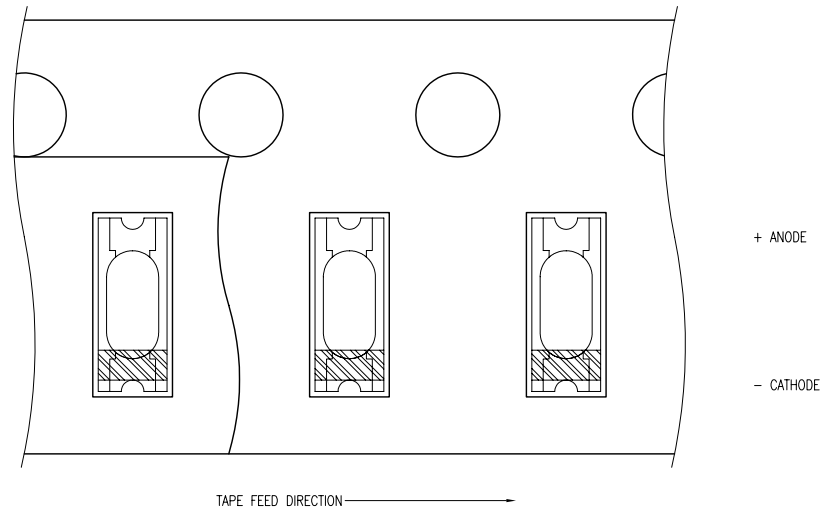
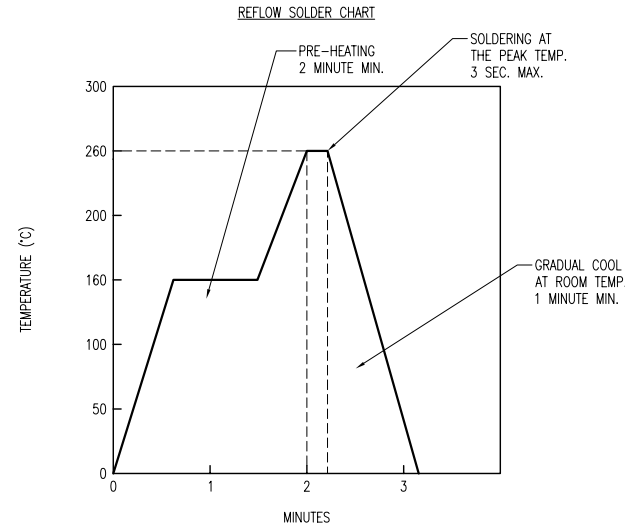

\*UNLESS OTHERWISE SPECIFIED TOLERANCES PER DECIMAL PRECISION ARE: X=±1 (±0.039), X,X=±0.5 (±0.020), X,XX=±0.25 (±0.010), X,XXX=±0.127 (±0.005). LEAD SIZE=±0.05 (±0.002), LEAD LENGTH=±0.75 (±0.030). MIN.= <sup>+0.00</sup>/<sub>-0.00</sub> DECIMAL PRECISION MAX.= <sup>+0.00</sup>/<sub>-0.00</sub> DECIMAL PRECISION

**LUMEX**  
 Creating LED and LCD Solutions Together.™

290 E. HELEN ROAD  
 PALATINE, IL 60067-6976  
 PHONE: +1.847.359.2790  
 FAX: +1.847.359.6538  
 WEB: WWW.LUMEX.COM

CERAMIC CHIP, SURFACE, MOUNT LED, YELLOW TRANSPARENT, TAPE AND REEL.

\*\*THE SPECIFICATIONS MAY CHANGE AT ANY TIME WITHOUT NOTICE DUE TO NEW MATERIALS OR PRODUCT IMPROVEMENT.\*\*

CONFIDENTIAL INFORMATION  
 THE INFORMATION CONTAINED IN THIS DOCUMENT IS THE PROPERTY OF LUMEX INC. EXCEPT AS SPECIFICALLY AUTHORIZED IN WRITING BY LUMEX INC., THE HOLDER OF THIS DOCUMENT SHALL KEEP ALL INFORMATION CONTAINED HEREIN CONFIDENTIAL AND SHALL PROTECT SAME IN WHOLE OR IN PART FROM DISCLOSURE AND DISSEMINATION TO ALL THIRD PARTIES.

DATE:	04.12.11	DRAWN BY:	AB
PAGE:	2 OF 2	CHKD BY:	SS
SCALE:	NTS	APRVD BY:	JD
UNIT:	mm [INCH]		Ⓟ

## Данный компонент на территории Российской Федерации

### Вы можете приобрести в компании MosChip.

Для оперативного оформления запроса Вам необходимо перейти по данной ссылке:

<http://moschip.ru/get-element>

Вы можете разместить у нас заказ для любого Вашего проекта, будь то серийное производство или разработка единичного прибора.

В нашем ассортименте представлены ведущие мировые производители активных и пассивных электронных компонентов.

Нашей специализацией является поставка электронной компонентной базы двойного назначения, продукции таких производителей как XILINX, Intel (ex.ALTERA), Vicor, Microchip, Texas Instruments, Analog Devices, Mini-Circuits, Amphenol, Glenair.

Сотрудничество с глобальными дистрибьюторами электронных компонентов, предоставляет возможность заказывать и получать с международных складов практически любой перечень компонентов в оптимальные для Вас сроки.

На всех этапах разработки и производства наши партнеры могут получить квалифицированную поддержку опытных инженеров.

Система менеджмента качества компании отвечает требованиям в соответствии с ГОСТ Р ИСО 9001, ГОСТ РВ 0015-002 и ЭС РД 009

### Офис по работе с юридическими лицами:

105318, г.Москва, ул.Щербаковская д.3, офис 1107, 1118, ДЦ «Щербаковский»

Телефон: +7 495 668-12-70 (многоканальный)

Факс: +7 495 668-12-70 (доб.304)

E-mail: [info@moschip.ru](mailto:info@moschip.ru)

Skype отдела продаж:

moschip.ru

moschip.ru\_4

moschip.ru\_6

moschip.ru\_9