

1. Not recommended for new designs

Features

- Compatible with I²C bus modes:
 - 400 kHz
 - 100 kHz
- Memory array:
 - 1 Kbit (128 bytes) of EEPROM
 - 2 Kbit (256 bytes) of EEPROM
 - Page size: 16 byte
- Single supply voltage:
 - M24C01/02-W: 2.5 V to 5.5 V
 - M24C01/02-R: 1.8 V to 5.5 V
 - M24C02-F: 1.7 V to 5.5 V (full temperature range) and 1.6 V to 1.7 V (limited temperature range)
- Write:
 - Byte Write within 5 ms
 - Page Write within 5 ms
- Operating temperature range:
 - from -40 °C up to +85 °C
- Random and sequential Read modes
- Write protect of the whole memory array
- Enhanced ESD/Latch-Up protection
- More than 4 million Write cycles
- More than 200-years data retention

Packages

- RoHS compliant and halogen-free (ECOPACK2[®])

Contents

1	Description	6
2	Signal description	8
2.1	Serial Clock (SCL)	8
2.2	Serial Data (SDA)	8
2.3	Chip Enable (E2, E1, E0)	8
2.4	Write Control (\overline{WC})	8
2.5	V _{SS} (ground)	8
2.6	Supply voltage (V _{CC})	8
2.6.1	Operating supply voltage (V _{CC})	8
2.6.2	Power-up conditions	9
2.6.3	Device reset	9
2.6.4	Power-down conditions	9
3	Memory organization	10
4	Device operation	11
4.1	Start condition	12
4.2	Stop condition	12
4.3	Data input	12
4.4	Acknowledge bit (ACK)	12
4.5	Device addressing	13
5	Instructions	14
5.1	Write operations	14
5.1.1	Byte Write	15
5.1.2	Page Write	16
5.1.3	Minimizing Write delays by polling on ACK	17
5.2	Read operations	18
5.2.1	Random Address Read	19
5.2.2	Current Address Read	19
5.2.3	Sequential Read	19

6	Initial delivery state	20
7	Maximum rating	21
8	DC and AC parameters	22
9	Package information	30
9.1	UFD5FN5 (DFN5) package information	30
9.2	TSSOP8 package information	32
9.3	SO8N package information	33
9.4	PDIP8 package information	35
9.5	UFD5FN8 (DFN8) package information	36
10	Ordering information	38
11	Revision history	40

List of tables

Table 1.	Signal names	6
Table 2.	Device select code	13
Table 3.	Address byte	14
Table 4.	Absolute maximum ratings	21
Table 5.	Operating conditions (voltage range W)	22
Table 6.	Operating conditions (voltage range R)	22
Table 7.	Operating conditions (voltage range F)	22
Table 8.	AC measurement conditions.	22
Table 9.	Input parameters.	23
Table 10.	Cycling performance.	23
Table 11.	Memory cell data retention	23
Table 12.	DC characteristics (M24C01/02-W, device grade 6).	24
Table 13.	DC characteristics (M24C01/02-R device grade 6)	25
Table 14.	DC characteristics (M24C02-F, device grade 6).	26
Table 15.	400 kHz AC characteristics (I ² C Fast-mode)	27
Table 16.	100 kHz AC characteristics (I ² C Standard mode).	28
Table 17.	UFDFPN5 - 1.7 × 1.4 mm, 0.55 mm thickness, ultra thin fine pitch dual flat package, no lead - package mechanical data	30
Table 18.	TSSOP8 – 3 x 4.4 mm, 0.65 mm pitch, 8-lead thin shrink small outline, package mechanical data	32
Table 19.	SO8N – 3.9x4.9 mm, 8-lead plastic small outline, 150 mils body width, package mechanical data	33
Table 20.	PDIP8 – 8-pin plastic DIP, 0.25 mm lead frame, package mechanical data.	35
Table 21.	UFDFPN8 - 8-lead, 2 × 3 mm, 0.5 mm pitch ultra thin profile fine pitch dual flat package mechanical data	36
Table 22.	Ordering information scheme	38
Table 23.	Document revision history	40

List of figures

Figure 1.	Logic diagram	6
Figure 2.	8-pin package connections, top view	6
Figure 3.	UFDFPN5 (DFN5) package connections	7
Figure 4.	Block diagram	10
Figure 5.	I ² C bus protocol	11
Figure 6.	Write mode sequences with $\overline{WC} = 0$ (data write enabled)	15
Figure 7.	Write mode sequences with $\overline{WC} = 1$ (data write inhibited)	16
Figure 8.	Write cycle polling flowchart using ACK	17
Figure 9.	Read mode sequences	18
Figure 10.	AC measurement I/O waveform	22
Figure 11.	Maximum Rbus value versus bus parasitic capacitance (Cbus) for an I2C bus at maximum frequency fC = 400 kHz.	29
Figure 12.	AC waveforms	29
Figure 13.	UFDFPN5 – 1.7x1.4 mm, 0.55 mm thickness, ultra thin fine pitch dual flat package, no lead - package outline	30
Figure 14.	UFDFPN5 - 5-lead, 1.7 × 1.4 mm, 0.55 mm thickness, ultra thin fine pitch dual flat package, no lead recommended footprint.	31
Figure 15.	TSSOP8 – 3x4.4 mm, 0.65 mm pitch, 8-lead thin shrink small outline, package outline.	32
Figure 16.	SO8N – 3.9x4.9 mm, 8-lead plastic small outline, 150 mils body width, package outline	33
Figure 17.	SO8N – 3.9x4.9 mm, 8-lead plastic small outline, 150 mils body width, package recommended footprint	34
Figure 18.	PDIP8 – 8-pin plastic DIP, 0.25 mm lead frame, package outline	35
Figure 19.	UFDFPN8 - 8-lead, 2 × 3 mm, 0.5 mm pitch ultra thin profile fine pitch dual flat package outline	36
Figure 20.	UFDFPN8 - 8-lead, 2 × 3 mm, 0.5 mm pitch ultra thin profile fine pitch dual flat recommended footprint	37

1 Description

The M24C01(C02) is a 1(2)-Kbit I²C-compatible EEPROM (Electrically Erasable PROgrammable Memory) organized as 128 (256) × 8 bits.

The M24C01/02-W can be accessed with a supply voltage from 2.5 V to 5.5 V, the M24C01/02-R can be accessed with a supply voltage from 1.8 V to 5.5 V, and the M24C02-F can be accessed either with a supply voltage from 1.7 V to 5.5 V (over the full temperature range) or with an extended supply voltage from 1.6 V to 1.7 V if the temperature is reduced to 0 °C/ 85 °C. All these devices operate with a maximum clock frequency of 400 kHz.

Figure 1. Logic diagram

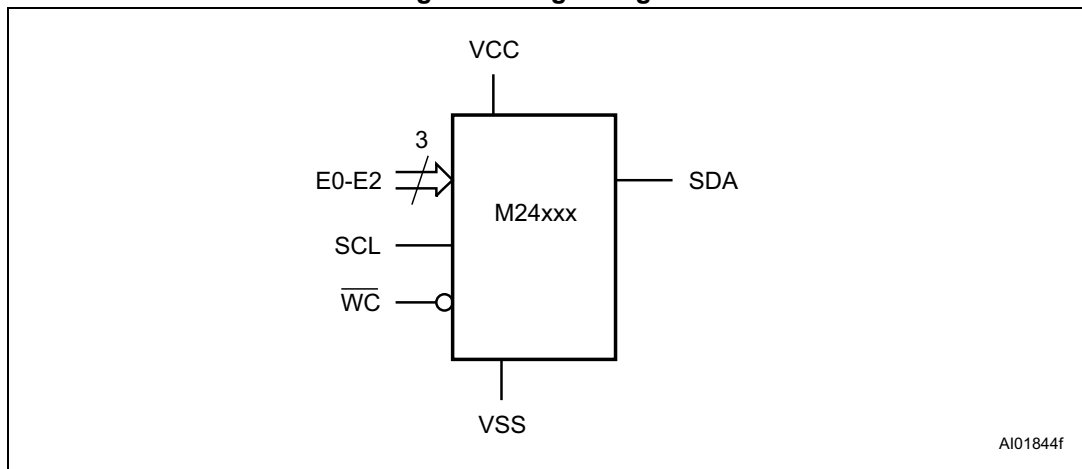

AI01844f

Table 1. Signal names

Signal name	Function	Direction
E2, E1, E0 ⁽¹⁾	Chip Enable	Input
SDA	Serial Data	I/O
SCL	Serial Clock	Input
\overline{WC}	Write Control	Input
V _{CC}	Supply voltage	-
V _{SS}	Ground	-

1. Signal not connected in the DFN5 package.

Figure 2. 8-pin package connections, top view

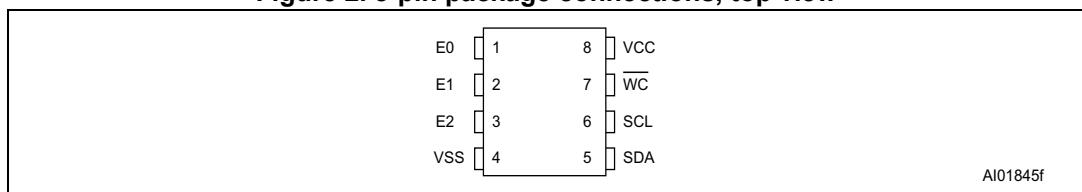

AI01845f

Figure 3. UFDFPN5 (DFN5) package connections

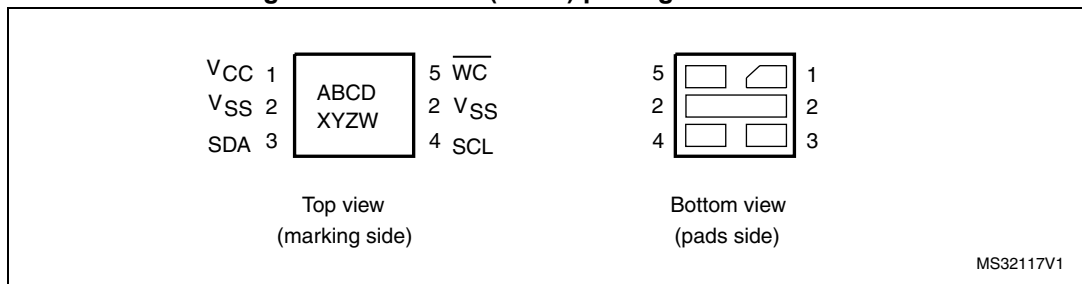

1. Inputs E2, E1, E0 are not connected, therefore read as (000). Please refer to [Section 2.3](#) for further explanations.

2 Signal description

2.1 Serial Clock (SCL)

The signal applied on the SCL input is used to strobe the data available on SDA(in) and to output the data on SDA(out).

2.2 Serial Data (SDA)

SDA is an input/output used to transfer data in or data out of the device. SDA(out) is an open drain output that may be wire-OR'ed with other open drain or open collector signals on the bus. A pull-up resistor must be connected from Serial Data (SDA) to V_{CC} ([Figure 11](#) indicates how to calculate the value of the pull-up resistor).

2.3 Chip Enable (E2, E1, E0)

(E2,E1,E0) input signals are used to set the value that is to be looked for on the three least significant bits (b3, b2, b1) of the 7-bit device select code. These inputs must be tied to V_{CC} or V_{SS} , as shown in [Table 2: Device select code](#). When not connected (left floating), these inputs are read as low (0).

For the UDFPN5 package, the (E2,E1,E0) inputs are not connected, therefore read as (0,0,0).

2.4 Write Control (\overline{WC})

This input signal is useful for protecting the entire contents of the memory from inadvertent write operations. Write operations are disabled to the entire memory array when Write Control (\overline{WC}) is driven high. Write operations are enabled when Write Control (\overline{WC}) is either driven low or left floating.

When Write Control (\overline{WC}) is driven high, device select and address bytes are acknowledged, Data bytes are not acknowledged.

2.5 V_{SS} (ground)

V_{SS} is the reference for the V_{CC} supply voltage.

2.6 Supply voltage (V_{CC})

2.6.1 Operating supply voltage (V_{CC})

Prior to selecting the memory and issuing instructions to it, a valid and stable V_{CC} voltage within the specified [$V_{CC}(\min)$, $V_{CC}(\max)$] range must be applied (see Operating conditions in [Section 8: DC and AC parameters](#)). In order to secure a stable DC supply voltage, it is recommended to decouple the V_{CC} line with a suitable capacitor (usually of the order of 10 nF to 100 nF) close to the V_{CC}/V_{SS} package pins.

This voltage must remain stable and valid until the end of the transmission of the instruction and, for a write instruction, until the completion of the internal write cycle (t_W).

2.6.2 Power-up conditions

The V_{CC} voltage has to rise continuously from 0 V up to the minimum V_{CC} operating voltage (see Operating conditions in [Section 8: DC and AC parameters](#)).

2.6.3 Device reset

In order to prevent inadvertent write operations during power-up, a power-on-reset (POR) circuit is included.

At power-up, the device does not respond to any instruction until V_{CC} has reached the internal reset threshold voltage. This threshold is lower than the minimum V_{CC} operating voltage (see Operating conditions in [Section 8: DC and AC parameters](#)). When V_{CC} passes over the POR threshold, the device is reset and enters the Standby Power mode; however, the device must not be accessed until V_{CC} reaches a valid and stable DC voltage within the specified [$V_{CC}(\text{min})$, $V_{CC}(\text{max})$] range (see Operating conditions in [Section 8: DC and AC parameters](#)).

In a similar way, during power-down (continuous decrease in V_{CC}), the device must not be accessed when V_{CC} drops below $V_{CC}(\text{min})$. When V_{CC} drops below the threshold voltage, the device stops responding to any instruction sent to it.

2.6.4 Power-down conditions

During power-down (continuous decrease in V_{CC}), the device must be in the Standby Power mode (mode reached after decoding a Stop condition, assuming that there is no internal write cycle in progress).

3 Memory organization

The memory is organized as shown below.

Figure 4. Block diagram

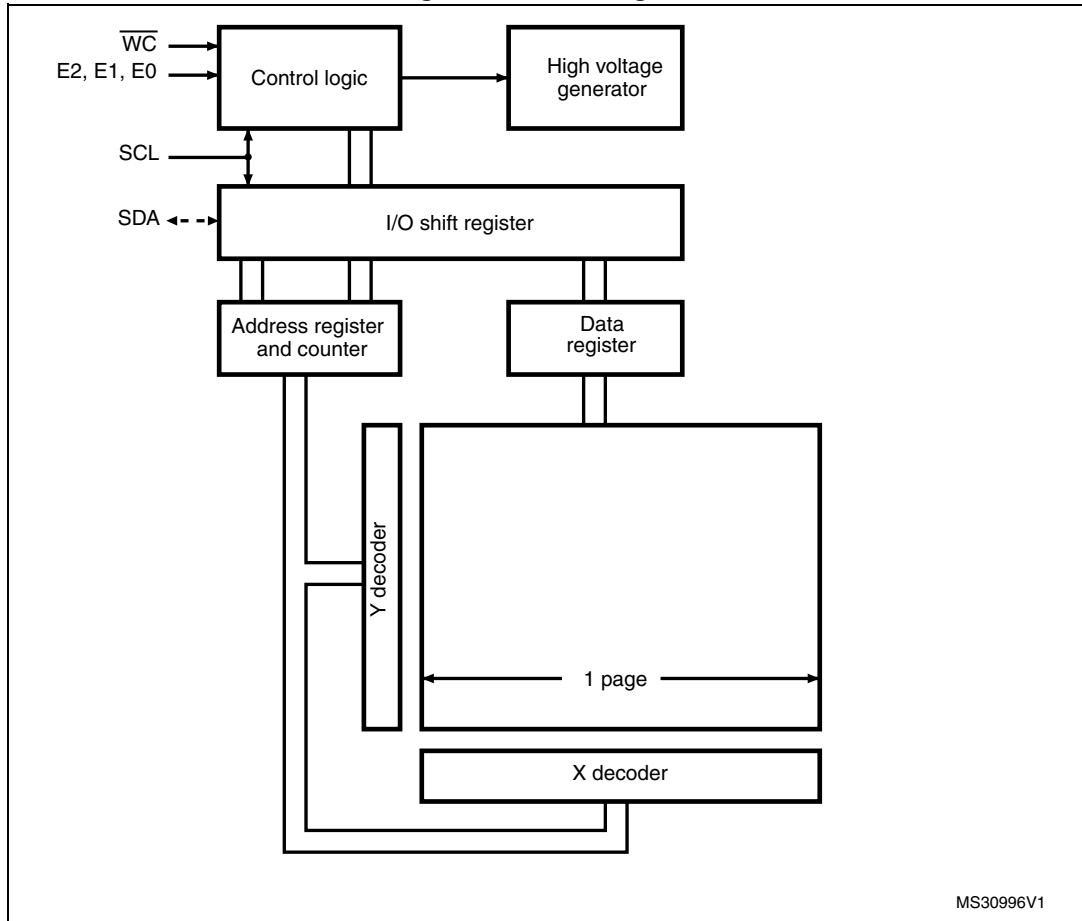

4 Device operation

The device supports the I²C protocol. This is summarized in [Figure 5](#). Any device that sends data on to the bus is defined to be a transmitter, and any device that reads the data to be a receiver. The device that controls the data transfer is known as the bus master, and the other as the slave device. A data transfer can only be initiated by the bus master, which will also provide the serial clock for synchronization. The device is always a slave in all communications.

Figure 5. I²C bus protocol



4.1 Start condition

Start is identified by a falling edge of Serial Data (SDA) while Serial Clock (SCL) is stable in the high state. A Start condition must precede any data transfer instruction. The device continuously monitors (except during a Write cycle) Serial Data (SDA) and Serial Clock (SCL) for a Start condition.

4.2 Stop condition

Stop is identified by a rising edge of Serial Data (SDA) while Serial Clock (SCL) is stable and driven high. A Stop condition terminates communication between the device and the bus master. A Read instruction that is followed by NoAck can be followed by a Stop condition to force the device into the Standby mode.

A Stop condition at the end of a Write instruction triggers the internal Write cycle.

4.3 Data input

During data input, the device samples Serial Data (SDA) on the rising edge of Serial Clock (SCL). For correct device operation, Serial Data (SDA) must be stable during the rising edge of Serial Clock (SCL), and the Serial Data (SDA) signal must change *only* when Serial Clock (SCL) is driven low.

4.4 Acknowledge bit (ACK)

The acknowledge bit is used to indicate a successful byte transfer. The bus transmitter, whether it be bus master or slave device, releases Serial Data (SDA) after sending eight bits of data. During the 9th clock pulse period, the receiver pulls Serial Data (SDA) low to acknowledge the receipt of the eight data bits.

4.5 Device addressing

To start communication between the bus master and the slave device, the bus master must initiate a Start condition. Following this, the bus master sends the device select code, shown in [Table 2](#) (most significant bit first).

When using the DFN5 package, the Ei pins are not accessible. These inputs are read as low (0).

As a result, to properly communicate with the device in DFN5 package, the E0, E1 and E2 bits must always be set to logic 0 for any operation. See [Table 2](#).

Table 2. Device select code

Package	Device type identifier ⁽¹⁾				Chip Enable address			R/W
	b7	b6	b5	b4	b3	b2	b1	b0
TSSOP8,SO8,PDIP8, UFDFPN8	1	0	1	0	E2	E1	E0	R/W
DFN5	1	0	1	0	0	0	0	R/W

1. The MSB b7 is sent first.

The 8th bit is the Read/Write bit (\overline{RW}). This bit is set to 1 for Read and 0 for Write operations.

If a match occurs on the device select code, the corresponding device gives an acknowledgment on Serial Data (SDA) during the 9th bit time. If the device does not match the device select code, it deselects itself from the bus, and goes into Standby mode.

5 Instructions

5.1 Write operations

Following a Start condition the bus master sends a device select code with the $\overline{R/W}$ bit (\overline{RW}) reset to 0. The device acknowledges this, as shown in [Figure 5](#), and waits for the address byte. The device responds to each address byte with an acknowledge bit, and then waits for the data byte.

Table 3. Address byte

A7	A6	A5	A4	A3	A2	A1	A0
----	----	----	----	----	----	----	----

When the bus master generates a Stop condition immediately after a data byte Ack bit (in the “10th bit” time slot), either at the end of a Byte Write or a Page Write, the internal Write cycle t_W is triggered. A Stop condition at any other time slot does not trigger the internal Write cycle.

After the Stop condition and the successful completion of an internal Write cycle (t_W), the device internal address counter is automatically incremented to point to the next byte after the last modified byte.

During the internal Write cycle, Serial Data (SDA) is disabled internally, and the device does not respond to any requests.

If the Write Control input (WC) is driven High, the Write instruction is not executed and the accompanying data bytes are *not* acknowledged, as shown in [Figure 6](#).

5.1.1 Byte Write

After the device select code and the address byte, the bus master sends one data byte. If the addressed location is Write-protected, by Write Control (\overline{WC}) being driven high, the device replies with NoAck, and the location is not modified. If, instead, the addressed location is not Write-protected, the device replies with Ack. The bus master terminates the transfer by generating a Stop condition, as shown in [Figure 5](#).

Figure 6. Write mode sequences with $\overline{WC} = 0$ (data write enabled)

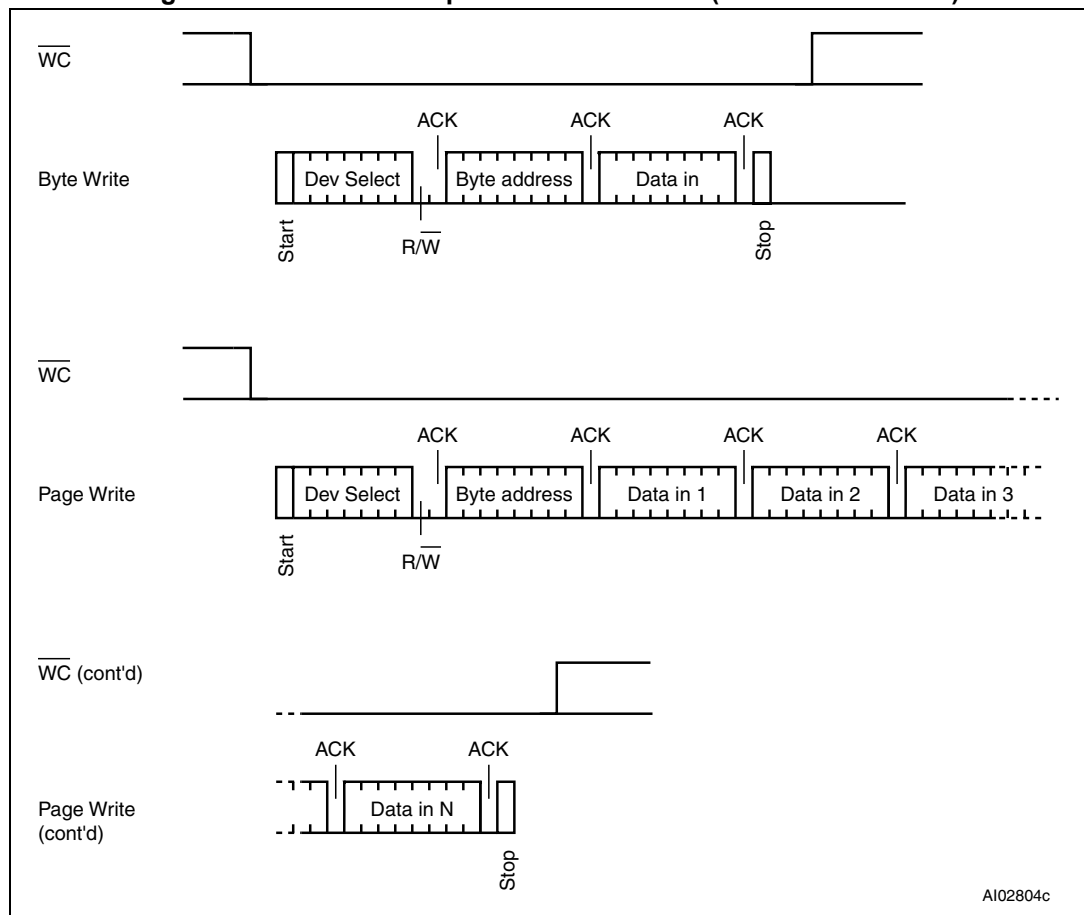

AI02804c

5.1.2 Page Write

The Page Write mode allows up to 16 byte to be written in a single Write cycle, provided that they are all located in the same page in the memory: that is, the most significant memory address bits, A8/A4, are the same. If more bytes are sent than will fit up to the end of the page, a “roll-over” occurs, i.e. the bytes exceeding the page end are written on the same page, from location 0.

The bus master sends from 1 to 16 byte of data, each of which is acknowledged by the device if Write Control (\overline{WC}) is low. If Write Control (\overline{WC}) is high, the contents of the addressed memory location are not modified, and each data byte is followed by a NoAck, as shown in *Figure 6*. After each transferred byte, the internal page address counter is incremented.

The transfer is terminated by the bus master generating a Stop condition.

Figure 7. Write mode sequences with $\overline{WC} = 1$ (data write inhibited)



5.1.3 Minimizing Write delays by polling on ACK

The maximum Write time (t_w) is shown in AC characteristics tables in [Section 8: DC and AC parameters](#), but the typical time is shorter. To make use of this, a polling sequence can be used by the bus master.

The sequence, as shown in [Figure 8](#), is:

- Initial condition: a Write cycle is in progress.
- Step 1: the bus master issues a Start condition followed by a device select code (the first byte of the new instruction).
- Step 2: if the device is busy with the internal Write cycle, no Ack will be returned and the bus master goes back to Step 1. If the device has terminated the internal Write cycle, it responds with an Ack, indicating that the device is ready to receive the second part of the instruction (the first byte of this instruction having been sent during Step 1).

Figure 8. Write cycle polling flowchart using ACK

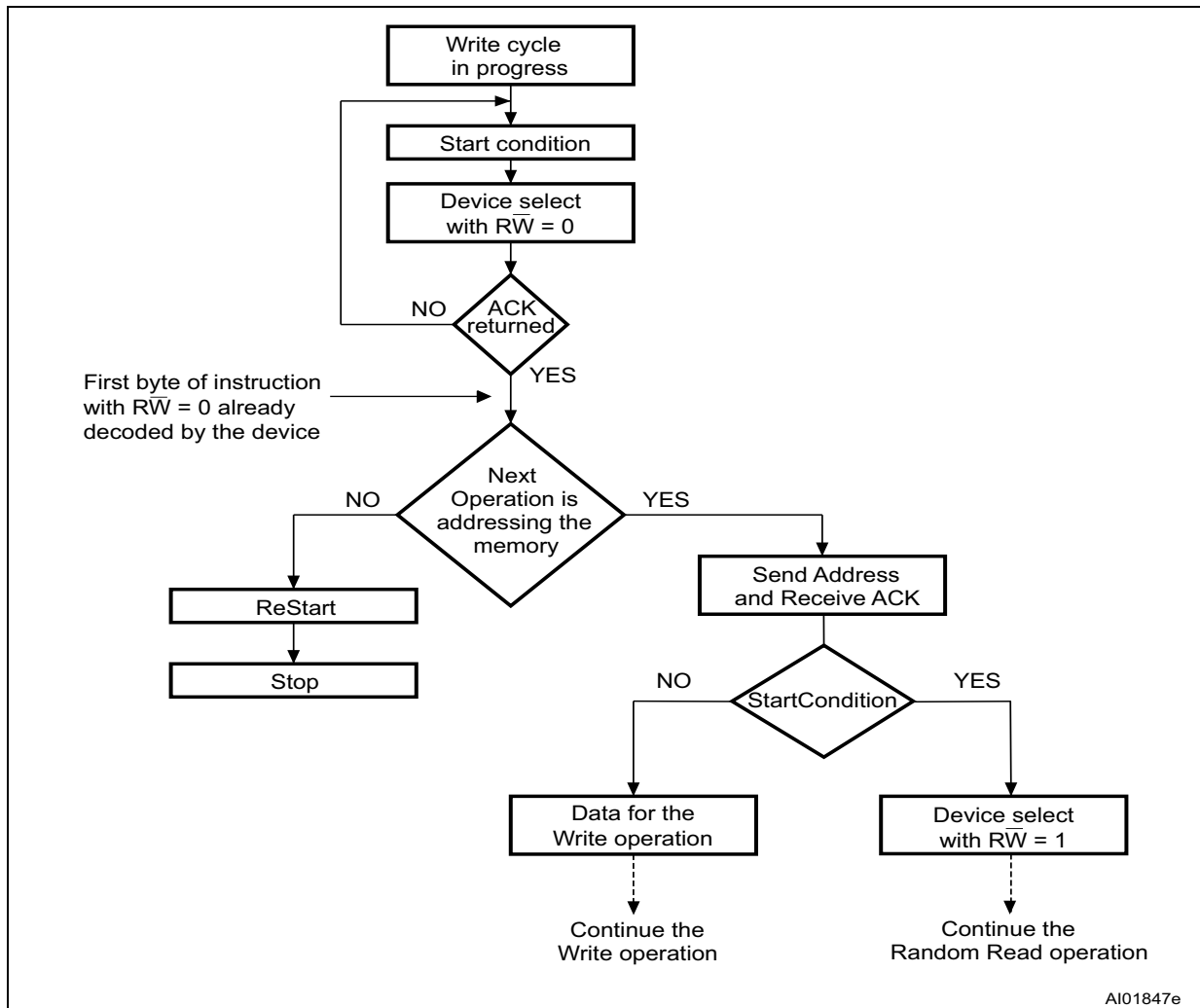

5.2 Read operations

Read operations are performed independently of the state of the Write Control (\overline{WC}) signal. After the successful completion of a Read operation, the device internal address counter is incremented by one, to point to the next byte address.

For the Read instructions, after each byte read (data out), the device waits for an acknowledgment (data in) during the 9th bit time. If the bus master does not acknowledge during this 9th time, the device terminates the data transfer and switches to its Standby mode.

Figure 9. Read mode sequences

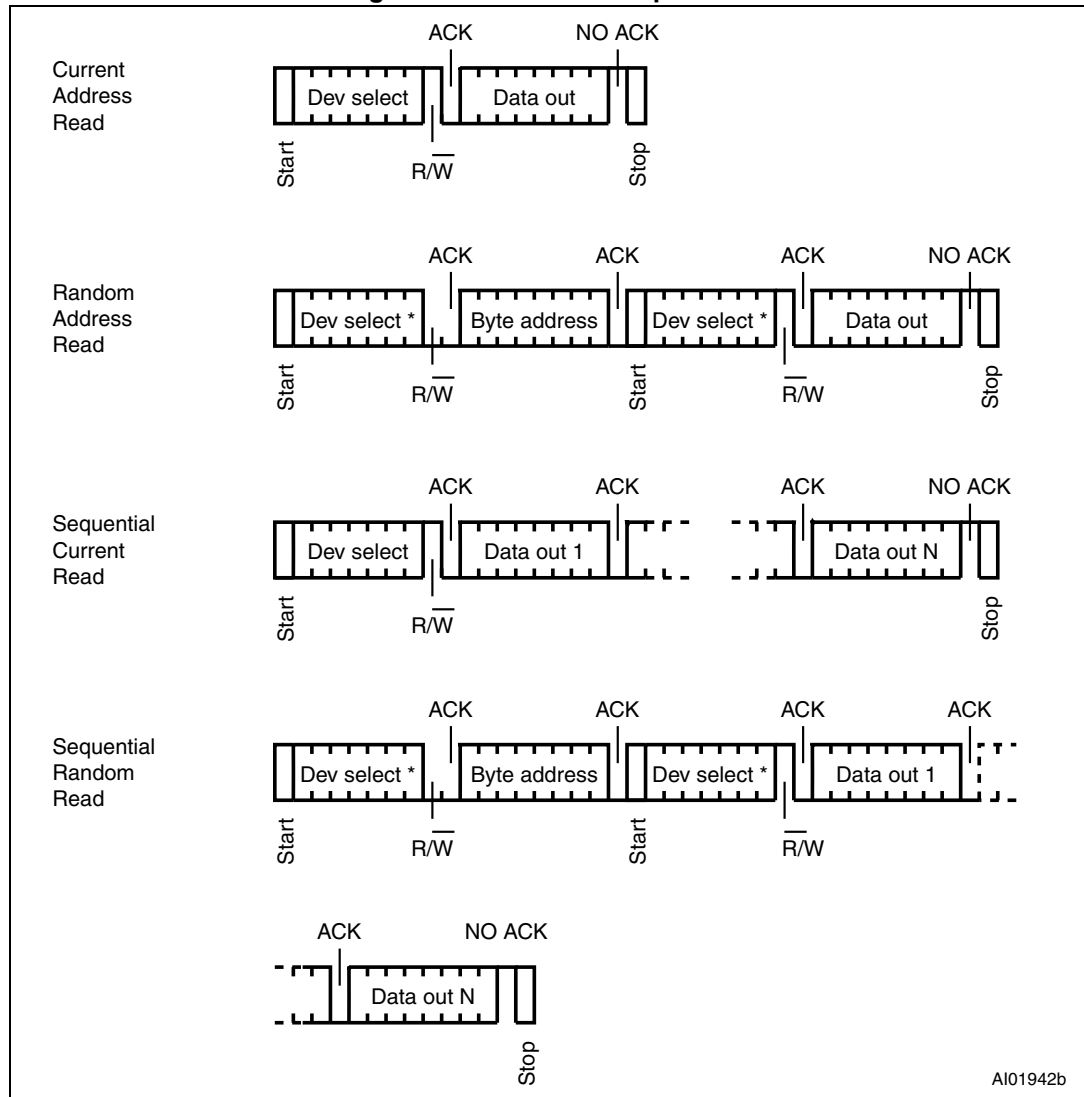

5.2.1 Random Address Read

A dummy Write is first performed to load the address into this address counter (as shown in [Figure 8](#)) but *without* sending a Stop condition. Then, the bus master sends another Start condition, and repeats the device select code, with the $\overline{R/W}$ bit set to 1. The device acknowledges this, and outputs the contents of the addressed byte. The bus master must *not* acknowledge the byte, and terminates the transfer with a Stop condition.

5.2.2 Current Address Read

For the Current Address Read operation, following a Start condition, the bus master only sends a device select code with the $\overline{R/W}$ bit set to 1. The device acknowledges this, and outputs the byte addressed by the internal address counter. The counter is then incremented. The bus master terminates the transfer with a Stop condition, as shown in [Figure 8](#), *without* acknowledging the byte.

5.2.3 Sequential Read

This operation can be used after a Current Address Read or a Random Address Read. The bus master *does* acknowledge the data byte output, and sends additional clock pulses so that the device continues to output the next byte in sequence. To terminate the stream of bytes, the bus master must *not* acknowledge the last byte, and *must* generate a Stop condition, as shown in [Figure 8](#).

The output data comes from consecutive addresses, with the internal address counter automatically incremented after each byte output. After the last memory address, the address counter “rolls-over”, and the device continues to output data from memory address 00h.

Note: For device delivered in DFN5 package, after the last memory address (7Fh for a 1Kbit and FFh for a 2Kbit), the address counter doesn't roll-over to the memory address 00h. The next addresses and data bytes outputted are therefore undefined and not guarantee.

The address counter will contain meaningful address value only after a Random Address Read (with address value between 0 and 7E for 1Kb and FE for 2 Kb) has been performed.

6 Initial delivery state

The device is delivered with all the memory array bits set to 1 (each byte contains FFh).

7 Maximum rating

Stressing the device outside the ratings listed in [Table 4](#) may cause permanent damage to the device. These are stress ratings only, and operation of the device at these, or any other conditions outside those indicated in the operating sections of this specification, is not implied. Exposure to absolute maximum rating conditions for extended periods may affect device reliability.

Table 4. Absolute maximum ratings

Symbol	Parameter	Min.	Max.	Unit
	Ambient operating temperature	-	130	°C
T _{STG}	Storage temperature	-65	150	°C
T _{LEAD}	Lead temperature during soldering	see note ⁽¹⁾		°C
	PDIP-specific lead temperature during soldering	-	260 ⁽²⁾	°C
I _{OL}	DC output current (SDA = 0)	-	5	mA
V _{IO}	Input or output range	-0.50	6.5	V
V _{CC}	Supply voltage	-0.50	6.5	V
V _{ESD}	Electrostatic pulse (Human Body model) ⁽³⁾	-	3000	V

1. Compliant with JEDEC Std J-STD-020D (for small body, Sn-Pb or Pb-free assembly), the ST ECOPACK2® 7191395 specification, and the European directive on Restrictions of Hazardous Substances (RoHS directive 2011/65/EU of July 2011).
2. T_{LEAD} max must not be applied for more than 10 s.
3. Positive and negative pulses applied on different combinations of pin connections, according to AEC-Q100-002 (compliant with ANSI/ESDA/JEDEC JS-001-2012 standard, C1=100 pF, R1=1500 Ω).

8 DC and AC parameters

This section summarizes the operating and measurement conditions, and the DC and AC characteristics of the device.

Table 5. Operating conditions (voltage range W)

Symbol	Parameter	Min.	Max.	Unit
V_{CC}	Supply voltage	2.5	5.5	V
T_A	Ambient operating temperature	-40	85	°C
f_C	Operating clock frequency	-	400	kHz

Table 6. Operating conditions (voltage range R)

Symbol	Parameter	Min.	Max.	Unit
V_{CC}	Supply voltage	1.8	5.5	V
T_A	Ambient operating temperature	-40	85	°C
f_C	Operating clock frequency	-	400	kHz

Table 7. Operating conditions (voltage range F)

Symbol	Parameter	Min.			Max.	Unit
V_{CC}	Supply voltage	1.60	1.65	1.70	5.5	V
T_A	Ambient operating temperature: READ	-40	-40	-40	85	°C
	Ambient operating temperature: WRITE	0	-20	-40	85	
f_C	Operating clock frequency	-	-	-	400	kHz

Table 8. AC measurement conditions

Symbol	Parameter	Min.	Max.	Unit
C_{bus}	Load capacitance	0	100	pF
-	SCL input rise/fall time, SDA input fall time	-	50	ns
-	Input levels	0.2 V_{CC} to 0.8 V_{CC}		V
-	Input and output timing reference levels	0.3 V_{CC} to 0.7 V_{CC}		V

Figure 10. AC measurement I/O waveform

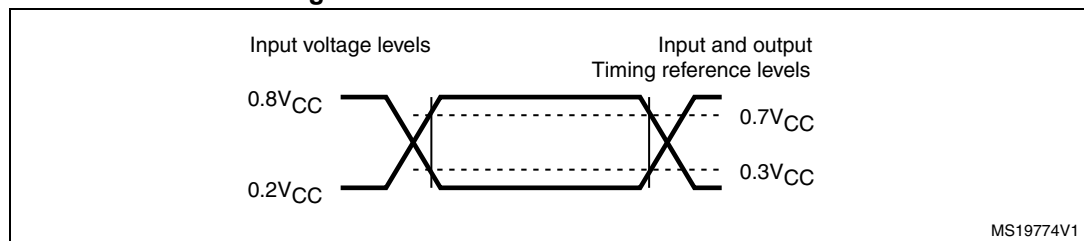

Table 9. Input parameters

Symbol	Parameter ⁽¹⁾	Test condition	Min.	Max.	Unit
C _{IN}	Input capacitance (SDA)	-	-	8	pF
C _{IN}	Input capacitance (other pins)	-	-	6	pF
Z _L	Input impedance (Ei, \overline{WC})	V _{IN} < 0.3 V _{CC}	15	70	kΩ
Z _H		V _{IN} > 0.7 V _{CC}	500	-	kΩ

1. Characterized only, not tested in production.

Table 10. Cycling performance⁽¹⁾

Symbol	Parameter	Test condition	Max.	Unit
Ncycle	Write cycle endurance	T _A ≤ 25 °C, V _{CC} (min) < V _{CC} < V _{CC} (max)	4,000,000	Write cycle
		T _A = 85 °C, V _{CC} (min) < V _{CC} < V _{CC} (max)	1,200,000	

1. Cycling performance for products identified by process letter T.

Table 11. Memory cell data retention

Parameter	Test condition	Min.	Unit
Data retention ⁽¹⁾	T _A = 55 °C	200	Year

1. For products identified by process letter T. The data retention behavior is checked in production, while the 200-year limit is defined from characterization and qualification results.

Table 12. DC characteristics (M24C01/02-W, device grade 6)

Symbol	Parameter	Test conditions (in addition to those in Table 5 and Table 8)	Min.	Max.	Unit
I_{LI}	Input leakage current (SCL, SDA, E2, E1)	$V_{IN} = V_{SS}$ or V_{CC} , device in Standby mode	-	± 2	μA
I_{LO}	Output leakage current	SDA in Hi-Z, external voltage applied on SDA: V_{SS} or V_{CC}	-	± 2	μA
I_{CC}	Supply current (Read)	$V_{CC} = 5.5 V, f_c = 400 kHz$	-	1 ⁽¹⁾	mA
		$V_{CC} = 2.5 V, f_c = 400 kHz$	-	1	mA
I_{CC0}	Supply current (Write)	During t_W , $2.5 V \leq V_{CC} \leq 5.5 V$	-	0.5 ⁽²⁾	mA
I_{CC1}	Standby supply current	Device not selected ⁽³⁾ , $V_{IN} = V_{SS}$ or $V_{CC}, V_{CC} = 2.5 V$	-	2	μA
		Device not selected ⁽³⁾ , $V_{IN} = V_{SS}$ or $V_{CC}, V_{CC} = 5.5 V$	-	3	μA
V_{IL}	Input low voltage (SCL, SDA, \overline{WC})	-	-0.45	$0.3 V_{CC}$	V
V_{IH}	Input high voltage (SCL, SDA, \overline{WC})	-	$0.7 V_{CC}$	$V_{CC} + 1$	V
V_{OL}	Output low voltage	$I_{OL} = 2.1 mA, V_{CC} = 2.5 V$ or $I_{OL} = 3 mA, V_{CC} = 5.5 V$	-	0.4	V

- 2 mA for devices identified by process letter G or S.
- Characterized only (not tested in production) for devices identified by process letter T. $I_{CC0(max)}$ is lower than 0.5 mA when writing data with an ambient temperature greater than 25 °C.
- The device is not selected after power-up, after a Read instruction (after the Stop condition), or after the completion of the internal write cycle t_W (t_W is triggered by the correct decoding of a Write instruction).

Table 13. DC characteristics (M24C01/02-R device grade 6)

Symbol	Parameter	Test conditions ⁽¹⁾ (in addition to those in Table 6 and Table 8)	Min.	Max.	Unit
I_{LI}	Input leakage current (Ei, SCL, SDA)	$V_{IN} = V_{SS}$ or V_{CC} , device in Standby mode	-	± 2	μA
I_{LO}	Output leakage current	SDA in Hi-Z, external voltage applied on SDA: V_{SS} or V_{CC}	-	± 2	μA
I_{CC}	Supply current (Read)	$V_{CC} = 1.8 V$, $f_c = 400 kHz$	-	0.8	mA
I_{CC0}	Supply current (Write)	During t_W $V_{CC} = 1.8 V \leq V_{CC} \leq 2.5 V$	-	0.5 ⁽²⁾	mA
I_{CC1}	Standby supply current	Device not selected ⁽³⁾ , $V_{IN} = V_{SS}$ or V_{CC} , $V_{CC} = 1.8 V$	-	1	μA
V_{IL}	Input low voltage (SCL, SDA, WC)	$2.5 V \leq V_{CC}$	-0.45	$0.3 V_{CC}$	V
		$V_{CC} < 2.5 V$	-0.45	$0.25 V_{CC}$	V
V_{IH}	Input high voltage (SCL, SDA)	$V_{CC} < 2.5 V$	$0.75 V_{CC}$	6.5	V
		$V_{CC} < 2.5 V$	$0.75 V_{CC}$	$V_{CC} + 0.6$	V
V_{OL}	Output low voltage	$I_{OL} = 0.7 mA$, $V_{CC} = 1.8 V$	-	0.2	V

1. If the application uses the voltage range R device with $2.5 V \leq V_{CC} \leq 5.5 V$ and $-40^\circ C < T_A < +85^\circ C$, please refer to [Table 12](#) instead of this table.
2. Characterized only (not tested in production) for devices identified by process letter T.
3. The device is not selected after power-up, after a Read instruction (after the Stop condition), or after the completion of the internal write cycle t_W (t_W is triggered by the correct decoding of a Write instruction).

Table 14. DC characteristics (M24C02-F, device grade 6)

Symbol	Parameter	Test conditions ⁽¹⁾ (in addition to those in Table 7 and Table 8)	Min.	Max.	Unit
I_{LI}	Input leakage current (Ei, SCL, SDA)	$V_{IN} = V_{SS}$ or V_{CC} , device in Standby mode	-	± 2	μA
I_{LO}	Output leakage current	$V_{OUT} = V_{SS}$ or V_{CC} , SDA in Hi-Z	-	± 2	μA
I_{CC}	Supply current (Read)	$V_{CC} = 1.6 V$ or $1.7 V$, $f_c = 400 kHz$	-	0.8	mA
I_{CC0}	Supply current (Write)	During t_W , $V_{CC} \leq 1.8V$	-	0.5 ⁽²⁾	mA
I_{CC1}	Standby supply current	Device not selected ⁽³⁾ , $V_{IN} = V_{SS}$ or V_{CC} , $V_{CC} \leq 1.8 V$	-	1	μA
V_{IL}	Input low voltage (SCL, SDA, WC)	$2.5 V \leq V_{CC}$	-0.45	$0.3 V_{CC}$	V
		$V_{CC} < 2.5 V$	-0.45	$0.25 V_{CC}$	V
V_{IH}	Input high voltage (SCL, SDA)	$V_{CC} < 2.5 V$	$0.75 V_{CC}$	6.5	V
		$V_{CC} < 2.5 V$	$0.75 V_{CC}$	$V_{CC} + 0.6$	V
V_{OL}	Output low voltage	$I_{OL} = 0.7 mA$, $V_{CC} \leq 1.8 V$	-	0.2	V

1. If the application uses the voltage range F device with $2.5 V \leq V_{CC} \leq 5.5 V$, please refer to [Table 12](#) instead of this table.
2. Characterized only (not tested in production) for devices identified by process letter T.
3. The device is not selected after power-up, after a Read instruction (after the Stop condition), or after the completion of the internal write cycle t_W (t_W is triggered by the correct decoding of a Write instruction).

Table 15. 400 kHz AC characteristics (I2C Fast-mode)

Symbol	Alt.	Parameter	Min.	Max.	Unit
f_C	f_{SCL}	Clock frequency	-	400	kHz
t_{CHCL}	t_{HIGH}	Clock pulse width high	600	-	ns
t_{CLCH}	t_{LOW}	Clock pulse width low	1300	-	ns
$t_{QL1QL2}^{(1)}$	t_F	SDA (out) fall time	20 ⁽²⁾	300	ns
t_{XH1XH2}	t_R	Input signal rise time	(3)	(3)	ns
t_{XL1XL2}	t_F	Input signal fall time	(3)	(3)	ns
t_{DXCH}	$t_{SU:DAT}$	Data in set up time	100	-	ns
t_{CLDX}	$t_{HD:DAT}$	Data in hold time	0	-	ns
$t_{CLQX}^{(4)}$	t_{DH}	Data out hold time	100	-	ns
$t_{CLQV}^{(5)}$	t_{AA}	Clock low to next data valid (access time)		900	ns
t_{CHDL}	$t_{SU:STA}$	Start condition setup time	600	-	ns
t_{DLCL}	$t_{HD:STA}$	Start condition hold time	600	-	ns
t_{CHDH}	$t_{SU:STO}$	Stop condition set up time	600	-	ns
t_{DHDL}	t_{BUF}	Time between Stop condition and next Start condition	1300	-	ns
t_W	t_{WR}	Write time	-	5	ms
$t_{NS}^{(1)}$	-	Pulse width ignored (input filter on SCL and SDA) - single glitch	-	100	ns

1. Characterized only, not tested in production.
2. With $C_L = 10$ pF.
3. There is no min. or max. values for the input signal rise and fall times. It is however recommended by the I²C specification that the input signal rise and fall times be more than 20 ns and less than 300 ns when $f_C < 400$ kHz.
4. The min value for t_{CLQX} (Data out hold time) of the M24xxx devices offers a safe timing to bridge the undefined region of the falling edge SCL.
5. t_{CLQV} is the time (from the falling edge of SCL) required by the SDA bus line to reach either 0.3 V_{CC} or 0.7 V_{CC} , assuming that $R_{bus} \times C_{bus}$ time constant is within the values specified in [Figure 11](#).

Table 16. 100 kHz AC characteristics (I²C Standard mode)⁽¹⁾

Symbol	Alt.	Parameter	Min.	Max.	Unit
f _C	f _{SCL}	Clock frequency	-	100	kHz
t _{CHCL}	t _{HIGH}	Clock pulse width high	4	-	μs
t _{CLCH}	t _{LOW}	Clock pulse width low	4.7	-	μs
t _{XH1XH2}	t _R	Input signal rise time	-	1	μs
t _{XL1XL2}	t _F	Input signal fall time	-	300	ns
t _{QL1QL2} ⁽²⁾	t _F	SDA fall time	-	300	ns
t _{DXCH}	t _{SU:DAT}	Data in setup time	250	-	ns
t _{CLDX}	t _{HD:DAT}	Data in hold time	0	-	ns
t _{CLQX} ⁽³⁾	t _{DH}	Data out hold time	200	-	ns
t _{CLQV} ⁽⁴⁾	t _{AA}	Clock low to next data valid (access time)	-	3450	ns
t _{CHDL} ⁽⁵⁾	t _{SU:STA}	Start condition setup time	4.7	-	μs
t _{DLCL}	t _{HD:STA}	Start condition hold time	4	-	μs
t _{CHDH}	t _{SU:STO}	Stop condition setup time	4	-	μs
t _{DHDL}	t _{BUF}	Time between Stop condition and next Start condition	4.7	-	μs
t _W	t _{WR}	Write time	-	5	ms
t _{NS} ⁽²⁾	-	Pulse width ignored (input filter on SCL and SDA), single glitch	-	100	ns

1. Values recommended by the I²C bus Standard-mode specification for a robust design of the I²C bus application. Note that the M24xxx devices decode correctly faster timings as specified in [Table 15: 400 kHz AC characteristics \(I²C Fast-mode\)](#).
2. Characterized only.
3. To avoid spurious Start and Stop conditions, a minimum delay is placed between SCL=1 and the falling or rising edge of SDA.
4. t_{CLQV} is the time (from the falling edge of SCL) required by the SDA bus line to reach either 0.3 V_{CC} or 0.7 V_{CC}, assuming that R_{bus} × C_{bus} time constant is within the values specified in [Figure 11](#).
5. For a reStart condition, or following a Write cycle.

Figure 11. Maximum R_{bus} value versus bus parasitic capacitance (C_{bus}) for an I2C bus at maximum frequency $f_C = 400$ kHz



Figure 12. AC waveforms



9 Package information

In order to meet environmental requirements, ST offers these devices in different grades of ECOPACK[®] packages, depending on their level of environmental compliance. ECOPACK[®] specifications, grade definitions and product status are available at: www.st.com. ECOPACK[®] is an ST trademark.

9.1 UFDFPN5 (DFN5) package information

Figure 13. UFDFPN5 – 1.7x1.4 mm, 0.55 mm thickness, ultra thin fine pitch dual flat package, no lead - package outline

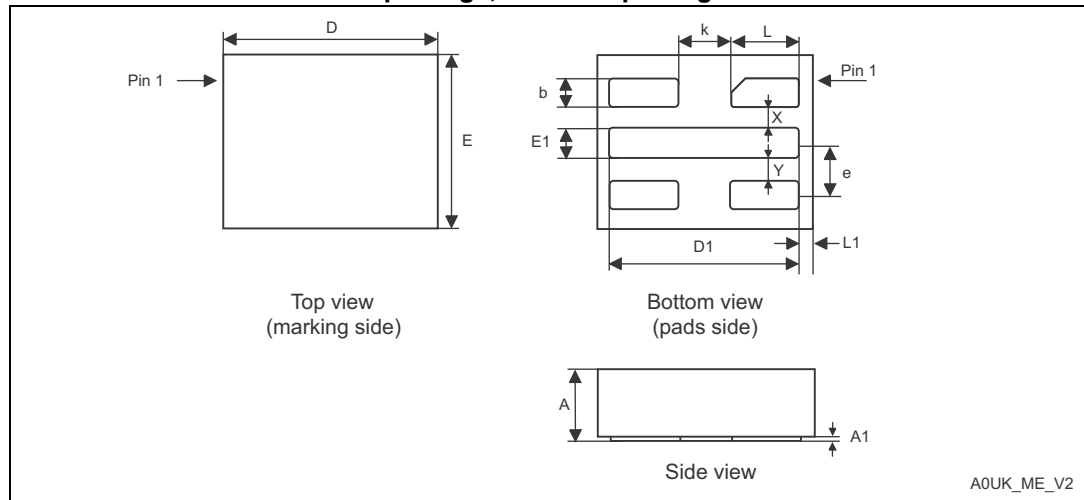

1. On the bottom side, pin 1 is identified by the specific pad shape and, on the top side, pin 1 is defined from the orientation of the marking: when reading the marking, pin 1 is below the upper left package corner.

Table 17. UFDFPN5 - 1.7 × 1.4 mm, 0.55 mm thickness, ultra thin fine pitch dual flat package, no lead - package mechanical data

Symbol	millimeters			inches ⁽¹⁾		
	Min	Typ	Max	Min	Typ	Max
A	0.500	0.550	0.600	0.0197	0.0217	0.0236
A1	0.000	-	0.050	0.0000	-	0.0020
b ⁽²⁾	0.175	0.200	0.225	0.0069	0.0079	0.0089
D	1.600	1.700	1.800	0.0630	0.0669	0.0709
D1	1.400	1.500	1.600	0.0551	0.0591	0.0630
E	1.300	1.400	1.500	0.0512	0.0551	0.0591
E1	0.175	0.200	0.225	0.0069	0.0079	0.0089
X	-	0.200	-	-	0.0079	-
Y	-	0.200	-	-	0.0079	-
e	-	0.400	-	-	0.0157	-

Table 17. UFDFPN5 - 1.7 × 1.4 mm, 0.55 mm thickness, ultra thin fine pitch dual flat package, no lead - package mechanical data (continued)

Symbol	millimeters			inches ⁽¹⁾		
	Min	Typ	Max	Min	Typ	Max
L	0.500	0.550	0.600	0.0197	0.0217	0.0236
L1	-	0.100	-	-	0.0039	-
k	-	0.400	-	-	0.0157	-

1. Values in inches are converted from mm and rounded to 4 decimal digits.
2. Dimension b applies to plated terminal and is measured between 0.15 and 0.30mm from the terminal tip.

Figure 14. UFDFPN5 - 5-lead, 1.7 × 1.4 mm, 0.55 mm thickness, ultra thin fine pitch dual flat package, no lead recommended footprint



1. Dimensions are expressed in millimeters.

9.2 TSSOP8 package information

Figure 15. TSSOP8 – 3x4.4 mm, 0.65 mm pitch, 8-lead thin shrink small outline, package outline



1. Drawing is not to scale.

Table 18. TSSOP8 – 3 x 4.4 mm, 0.65 mm pitch, 8-lead thin shrink small outline, package mechanical data

Symbol	millimeters			inches ⁽¹⁾		
	Min.	Typ.	Max.	Min.	Typ.	Max.
A	-	-	1.200	-	-	0.0472
A1	0.050	-	0.150	0.0020	-	0.0059
A2	0.800	1.000	1.050	0.0315	0.0394	0.0413
b	0.190	-	0.300	0.0075	-	0.0118
c	0.090	-	0.200	0.0035	-	0.0079
CP	-	-	0.100	-	-	0.0039
D	2.900	3.000	3.100	0.1142	0.1181	0.1220
e	-	0.650	-	-	0.0256	-
E	6.200	6.400	6.600	0.2441	0.2520	0.2598
E1	4.300	4.400	4.500	0.1693	0.1732	0.1772
L	0.450	0.600	0.750	0.0177	0.0236	0.0295
L1	-	1.000	-	-	0.0394	-
α	0°	-	8°	0°	-	8°

1. Values in inches are converted from mm and rounded to four decimal digits.

9.3 SO8N package information

Figure 16. SO8N – 3.9x4.9 mm, 8-lead plastic small outline, 150 mils body width, package outline



1. Drawing is not to scale.

Table 19. SO8N – 3.9x4.9 mm, 8-lead plastic small outline, 150 mils body width, package mechanical data

Symbol	millimeters			inches ⁽¹⁾		
	Min.	Typ.	Max.	Min.	Typ.	Max.
A	-	-	1.750	-	-	0.0689
A1	0.100	-	0.250	0.0039	-	0.0098
A2	1.250	-	-	0.0492	-	-
b	0.280	-	0.480	0.0110	-	0.0189
c	0.170	-	0.230	0.0067	-	0.0091
D	4.800	4.900	5.000	0.1890	0.1929	0.1969
E	5.800	6.000	6.200	0.2283	0.2362	0.2441
E1	3.800	3.900	4.000	0.1496	0.1535	0.1575
e	-	1.270	-	-	0.0500	-
h	0.250	-	0.500	0.0098	-	0.0197
k	0°	-	8°	0°	-	8°
L	0.400	-	1.270	0.0157	-	0.0500
L1	-	1.040	-	-	0.0409	-
ccc	-	-	0.100	-	-	0.0039

1. Values in inches are converted from mm and rounded to four decimal digits.

Figure 17. SO8N – 3.9x4.9 mm, 8-lead plastic small outline, 150 mils body width, package recommended footprint



1. Dimensions are expressed in millimeters.

9.4 PDIP8 package information

Figure 18. PDIP8 – 8-pin plastic DIP, 0.25 mm lead frame, package outline



1. Drawing is not to scale.
2. Not recommended for new designs.

Table 20. PDIP8 – 8-pin plastic DIP, 0.25 mm lead frame, package mechanical data

Symbol	millimeters			inches ⁽¹⁾		
	Min.	Typ.	Max.	Min.	Typ.	Max.
A	-	-	5.33	-	-	0.2098
A1	0.38	-	-	0.0150	-	-
A2	2.92	3.30	4.95	0.1150	0.1299	0.1949
b	0.36	0.46	0.56	0.0142	0.0181	0.0220
b2	1.14	1.52	1.78	0.0449	0.0598	0.0701
c	0.20	0.25	0.36	0.0079	0.0098	0.0142
D	9.02	9.27	10.16	0.3551	0.3650	0.4000
E	7.62	7.87	8.26	0.3000	0.3098	0.3252
E1	6.10	6.35	7.11	0.2402	0.2500	0.2799
e	-	2.54	-	-	0.1000	-
eA	-	7.62	-	-	0.3000	-
eB	-	-	10.92	-	-	0.4299
L	2.92	3.30	3.81	0.1150	0.1299	0.1500

1. Values in inches are converted from mm and rounded to four decimal digits.

9.5 UDFPN8 (DFN8) package information

Figure 19. UDFPN8 - 8-lead, 2 × 3 mm, 0.5 mm pitch ultra thin profile fine pitch dual flat package outline



1. Max. package warpage is 0.05 mm.
2. Exposed copper is not systematic and can appear partially or totally according to the cross section.
3. Drawing is not to scale.
4. The central pad (the area E2 by D2 in the above illustration) must be either connected to VSS or left floating (not connected) in the end application.

Table 21. UDFPN8 - 8-lead, 2 × 3 mm, 0.5 mm pitch ultra thin profile fine pitch dual flat package mechanical data

Symbol	millimeters			inches ⁽¹⁾		
	Min	Typ	Max	Min	Typ	Max
A	0.450	0.550	0.600	0.0177	0.0217	0.0236
A1	0.000	0.020	0.050	0.0000	0.0008	0.0020
b ⁽²⁾	0.200	0.250	0.300	0.0079	0.0098	0.0118
D	1.900	2.000	2.100	0.0748	0.0787	0.0827
D2	1.200	-	1.600	0.0472	-	0.0630
E	2.900	3.000	3.100	0.1142	0.1181	0.1220

Table 21. UFDFPN8 - 8-lead, 2 × 3 mm, 0.5 mm pitch ultra thin profile fine pitch dual flat package mechanical data (continued)

Symbol	millimeters			inches ⁽¹⁾		
	Min	Typ	Max	Min	Typ	Max
E2	1.200	-	1.600	0.0472	-	0.0630
e	-	0.500	-	0.0197		
K	0.300	-	-	0.0118	-	-
L	0.300	-	0.500	0.0118	-	0.0197
L1	-	-	0.150	-	-	0.0059
L3	0.300	-	-	0.0118	-	-
aaa	-	-	0.150	-	-	0.0059
bbb	-	-	0.100	-	-	0.0039
ccc	-	-	0.100	-	-	0.0039
ddd	-	-	0.050	-	-	0.0020
eee ⁽³⁾	-	-	0.080	-	-	0.0031

1. Values in inches are converted from mm and rounded to 4 decimal digits.
2. Dimension b applies to plated terminal and is measured between 0.15 and 0.30 mm from the terminal tip.
3. Applied for exposed die paddle and terminals. Exclude embedding part of exposed die paddle from measuring.

Figure 20. UFDFPN8 - 8-lead, 2 × 3 mm, 0.5 mm pitch ultra thin profile fine pitch dual flat recommended footprint



1. Dimensions are expressed in millimeters.

10 Ordering information

Table 22. Ordering information scheme

Example:	M24C02	W	MC	6	T	P
Device type	M24 = I ² C serial access EEPROM					
Device function						
C01 = 1 Kbit (128 x 8 bit)						
C02 = 2 Kbit (256 x 8 bit)						
Operating voltage	W = V _{CC} = 2.5 V to 5.5 V R = V _{CC} = 1.8 V to 5.5 V F = V _{CC} = 1.6 V or 1.7 V to 5.5 V					
Package						
BN = PDIP8 ⁽¹⁾⁽²⁾ MN = SO8 (150 mil width) ⁽³⁾ DW = TSSOP8 (169 mil width) ⁽³⁾ MC = UDFPN8 (DFN8) ⁽³⁾ MH = UDFPN5 (DFN5) ⁽³⁾						
Device grade	6 = Industrial: device tested with standard test flow over -40 to 85 °C					
Option	T = Tape and reel packing blank = tube packing					
Plating technology	P or G = ECOPACK2 [®] (RoHS compliant)					
	1. RoHS-compliant (ECOPACK1 [®]) 2. Not recommended for new designs. 3. ECOPACK2 [®] (RoHS compliant and free of brominated, chlorinated and antimony-oxide flame retardants)					

Engineering samples

Parts marked as ES or E are not yet qualified and therefore not approved for use in production. ST is not responsible for any consequences deriving from such use. In no event, will ST be liable for the customer using of these engineering samples in production. ST's quality department must be contacted prior to any decision to use these engineering samples to run qualification activity.

11 Revision history

Table 23. Document revision history

Date	Revision	Changes
17-Dec-2012	1	<p>New M24C01/02 datasheet resulting from splitting the previous datasheet M24C08-x M24C04-x M24C02-x M24C01-x (revision 18) into separate datasheets.</p> <p>Added part number M24C02-F.</p> <p>Updated ESD value in Table 4.</p> <p>Updated standby supply current values (I_{CC1}) in Table 12, Table 13 and Table 14.</p>
24-Sep-2013	2	<p>Added:</p> <ul style="list-style-type: none"> – Table 10: Cycling performance – Table 7: Operating conditions (voltage range F) and Table 7: Operating conditions (voltage range F, for all other devices) <p>Updated:</p> <ul style="list-style-type: none"> – Features: supply voltage, write cycles and data retention – Section 1: Description – Note ⁽¹⁾ under Table 4: Absolute maximum ratings – Table 11: Memory cell data retention, Table 12: DC characteristics (M24C01/02-W, device grade 6), Table 13: DC characteristics (M24C01/02-R device grade 6), Table 14: DC characteristics (M24C02-F, device grade 6), Table 21: Ordering information scheme – Figure 11: AC waveforms <p>Renamed Figure 15 and Table 21.</p>
06-Dec-2016	3	<p>Updated: Section 1: Description, notes on Table 4: Absolute maximum ratings, title of Table 7: Operating conditions (voltage range F), note 1 on Table 11: Memory cell data retention, Table 12: DC characteristics (M24C01/02-W, device grade 6), Table 13: DC characteristics (M24C01/02-R device grade 6), Table 14: DC characteristics (M24C02-F, device grade 6), Table 21: Ordering information scheme</p> <p>Removed Table 7: Operating conditions (voltage range F, for all other devices)</p> <p>Added Figure 14: SO8N – 3.9x4.9 mm, 8-lead plastic small outline, 150 mils body width, package recommended footprint, Engineering samples reference</p>
05-Apr-2017	4	<p>Updated Section 2.3: Chip Enable (E2, E1, E0), Section 4.5: Device addressing, Section 5.2.3: Sequential Read, Table 22: Ordering information scheme</p> <p>Added UFDFPN5 package in cover page and Section 9.1: UFDFPN5 (DFN5) package information</p>

Table 23. Document revision history (continued)

Date	Revision	Changes
20-Apr-2017	5	Updated: – <i>Figure 14: UFDFPN5 - 5-lead, 1.7 × 1.4 mm, 0.55 mm thickness, ultra thin fine pitch dual flat package, no lead recommended footprint</i> and <i>Figure 20: UFDFPN8 - 8-lead, 2 × 3 mm, 0.5 mm pitch ultra thin profile fine pitch dual flat recommended footprint</i> – Note on <i>Section 5.2.3: Sequential Read</i>
02-Oct-2017	6	Added reference to DFN8 and DFN5 in: <i>Figure 3: UFDFPN5 (DFN5) package connections, Section 9.1: UFDFPN5 (DFN5) package information, Section 9.5: UFDFPN8 (DFN8) package information, Table 22: Ordering information scheme</i>

IMPORTANT NOTICE – PLEASE READ CAREFULLY

STMicroelectronics NV and its subsidiaries ("ST") reserve the right to make changes, corrections, enhancements, modifications, and improvements to ST products and/or to this document at any time without notice. Purchasers should obtain the latest relevant information on ST products before placing orders. ST products are sold pursuant to ST's terms and conditions of sale in place at the time of order acknowledgement.

Purchasers are solely responsible for the choice, selection, and use of ST products and ST assumes no liability for application assistance or the design of Purchasers' products.

No license, express or implied, to any intellectual property right is granted by ST herein.

Resale of ST products with provisions different from the information set forth herein shall void any warranty granted by ST for such product.

ST and the ST logo are trademarks of ST. All other product or service names are the property of their respective owners.

Information in this document supersedes and replaces information previously supplied in any prior versions of this document.

© 2017 STMicroelectronics – All rights reserved

Данный компонент на территории Российской Федерации

Вы можете приобрести в компании MosChip.

Для оперативного оформления запроса Вам необходимо перейти по данной ссылке:

<http://moschip.ru/get-element>

Вы можете разместить у нас заказ для любого Вашего проекта, будь то серийное производство или разработка единичного прибора.

В нашем ассортименте представлены ведущие мировые производители активных и пассивных электронных компонентов.

Нашей специализацией является поставка электронной компонентной базы двойного назначения, продукции таких производителей как XILINX, Intel (ex.ALTERA), Vicor, Microchip, Texas Instruments, Analog Devices, Mini-Circuits, Amphenol, Glenair.

Сотрудничество с глобальными дистрибьюторами электронных компонентов, предоставляет возможность заказывать и получать с международных складов практически любой перечень компонентов в оптимальные для Вас сроки.

На всех этапах разработки и производства наши партнеры могут получить квалифицированную поддержку опытных инженеров.

Система менеджмента качества компании отвечает требованиям в соответствии с ГОСТ Р ИСО 9001, ГОСТ РВ 0015-002 и ЭС РД 009

Офис по работе с юридическими лицами:

105318, г.Москва, ул.Щербаковская д.3, офис 1107, 1118, ДЦ «Щербаковский»

Телефон: +7 495 668-12-70 (многоканальный)

Факс: +7 495 668-12-70 (доб.304)

E-mail: info@moschip.ru

Skype отдела продаж:

moschip.ru

moschip.ru_4

moschip.ru_6

moschip.ru_9