

GLASS PASSIVATED SUPER FAST RECTIFIER

VOLTAGE RANGE 50 to 600 Volts CURRENT 3.0 Amperes

FEATURES

- * High reliability
- * Low leakage
- * Low forward voltage
- * High current capability
- * Super fast switching speed
- * High surge capability
- * Good for switching mode circuit

MECHANICAL DATA

- * Case: Molded plastic
- * Epoxy: Device has UL flammability classification 94V-0
- * Lead: MIL-STD-202E method 208C guaranteed
- * Mounting position: Any
- * Weight: 1.18 g rms



DO-201AD

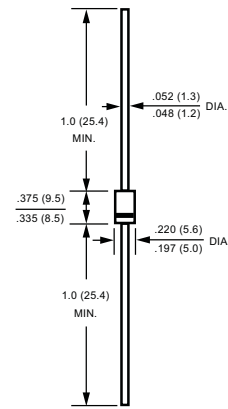

MAXIMUM RATINGS AND ELECTRICAL CHARACTERISTICS

Ratings at 25 °C ambient temperature unless otherwise specified.
resistive or inductive load.

MAXIMUM RATINGS (@ TA=25 °C unless otherwise noted)

RATINGS	SYMBOL	SF31	SF32	SF33	SF34	SF35	SF36	SF37	UNITS
Maximum Recurrent Peak Reverse Voltage	VRRM	50	100	150	200	300	400	600	Volts
Maximum RMS Voltage	VRMS	35	70	105	140	210	280	420	Volts
Maximum DC Blocking Voltage	VDC	50	100	150	200	300	400	600	Volts
Maximum Average Forward Rectified Current at TA = 55°C	IO	3.0							Amps
Peak Forward Surge Current 8.3 ms single half sine-wave superimposed on rated load (JEDEC method)	IFSM	125							Amps
Current Squared Time	I ² t	64.8							A ² /Sec
Typical Thermal Resistance (Note 3)	RθJA	20							°CW
	RθJL	8.0							
Typical Junction Capacitance (Note 2)	CJ	50				30			pF
Operating and Storage Temperature Range	TJ, TSTG	-55 to + 150							°C

ELECTRICAL CHARACTERISTICS (@TA=25 °C unless otherwise noted)

CHARACTERISTICS	SYMBOL	SF31	SF32	SF33	SF34	SF35	SF36	SF37	UNITS
Maximum Instantaneous Forward Voltage at 3.0A DC	VF	0.95				1.25		1.50	Volts
Maximum DC Reverse Current at Rated DC Blocking Voltage	IR	@TA = 25°C							uAmps
		5.0							
Maximum Reverse Recovery Time (Note 1)	trr	@TA = 100°C						50	nSec
		100							

- NOTES : 1. Test Conditions: IF = 0.5A, IR = -1.0A, IRR = -0.25A
 2. Measured at 1 MHz and applied reverse voltage of 4.0 volts.
 3. Typical Thermal Resistance : At 9.5mm lead lengths,PCB mounted.
 4. "Fully ROHS compliant", "100% Sn plating (Pb-free)"

RATING AND CHARACTERISTICS CURVES (SF31 THRU SF37)

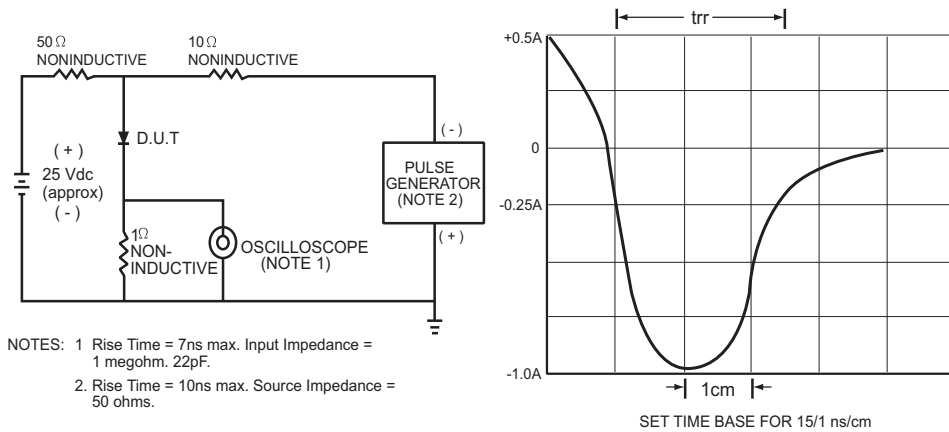

FIG.1 TEST CIRCUIT DIAGRAM AND REVERSE RECOVERY TIME CHARACTERISTIC

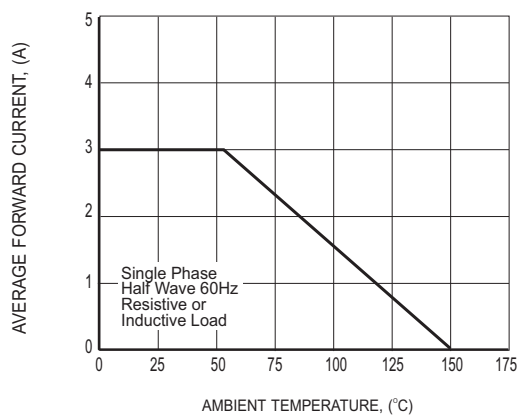

FIG.2 TYPICAL FORWARD CURRENT DERATING CURVE

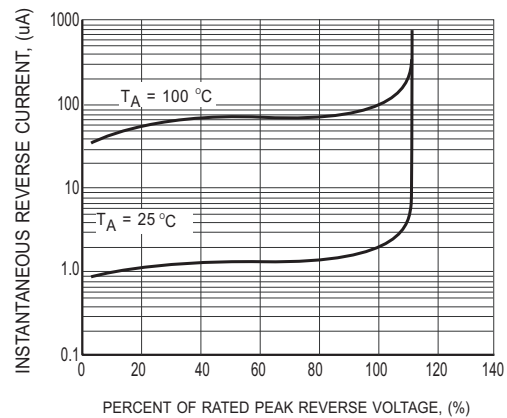

FIG.3 TYPICAL REVERSE CHARACTERISTICS

RATING AND CHARACTERISTICS CURVES (SF31 THRU SF37)

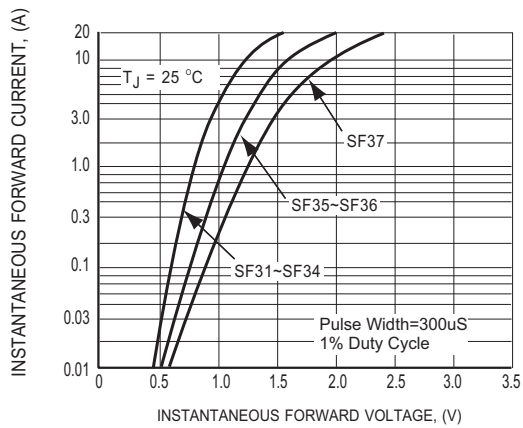

FIG.4 TYPICAL INSTANTANEOUS FORWARD CHARACTERISTICS

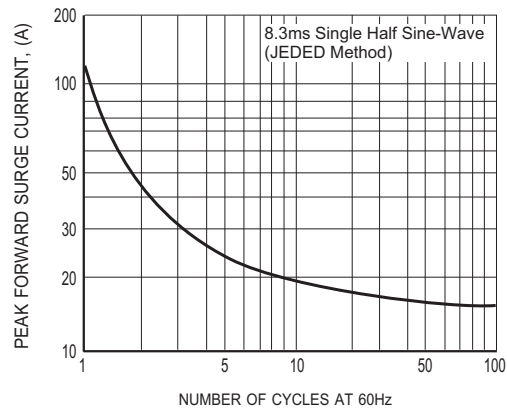

FIG.5 MAXIMUM NON-REPETITIVE FORWARD SURGE CURRENT

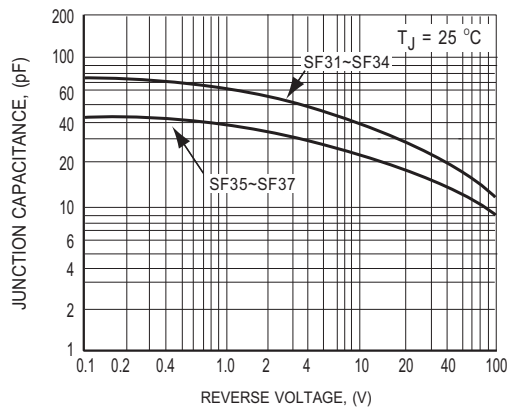
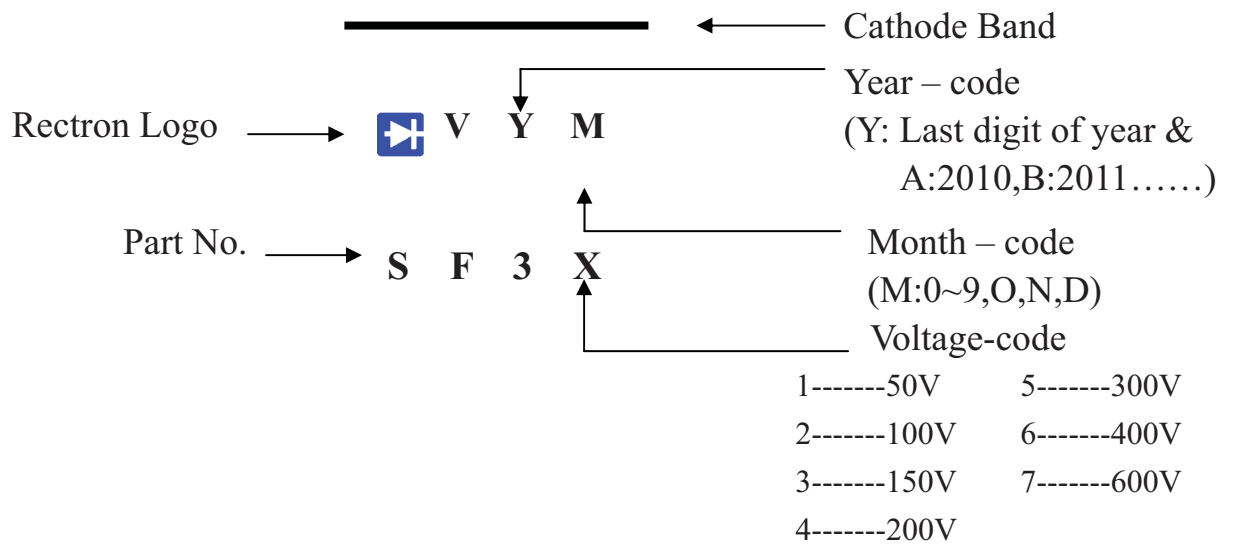

FIG.6 TYPICAL JUNCTION CAPACITANCE

Marking Description



PACKAGING OF DIODE AND BRIDGE RECTIFIERS

BULK PACK

PACKAGE	PACKING CODE	EA PER BOX	INNER BOX SIZE (mm)	CARTON SIZE (mm)	EA PER CARTON	GROSS WEIGHT(Kg)
DO-201	-B	500	300*73*40	347*320*271	12,000	15.9

REEL PACK

PACKAGE	PACKING CODE	EA PER REEL	EA PER INNER BOX	COMPONENT SPACE (mm)	TAPE SPACE (mm)	REEL DIA (mm)	CARTON SIZE (mm)	EA PER CARTON	GROSS WEIGHT(Kg)
DO-201	-T	1,200	1,200	5.0	52	330	355*350*335	4,800	9.10

AMMO PACK

PACKAGE	PACKING CODE	REEL (EA)	COMPONENT SPACE(mm)	TAPE SPACE (mm)	BOX SIZE (mm)	CARTON SIZE(mm)	CARTON (EA)	GROSS WEIGHT (Kg)
DO-201	-F	600	9.5	52	255*73*100	400*268*225	6,000	9.9

DISCLAIMER NOTICE

Rectron Inc reserves the right to make changes without notice to any product specification herein, to make corrections, modifications, enhancements or other changes. Rectron Inc or anyone on its behalf assumes no responsibility or liability for any errors or inaccuracies. Data sheet specifications and its information contained are intended to provide a product description only. "Typical" parameters which may be included on RECTRON data sheets and/ or specifications can and do vary in different applications and actual performance may vary over time. Rectron Inc does not assume any liability arising out of the application or use of any product or circuit.

Rectron products are not designed, intended or authorized for use in medical, life-saving implant or other applications intended for life-sustaining or other related applications where a failure or malfunction of component or circuitry may directly or indirectly cause injury or threaten a life without expressed written approval of Rectron Inc. Customers using or selling Rectron components for use in such applications do so at their own risk and shall agree to fully indemnify Rectron Inc and its subsidiaries harmless against all claims, damages and expenditures.

Данный компонент на территории Российской Федерации

Вы можете приобрести в компании MosChip.

Для оперативного оформления запроса Вам необходимо перейти по данной ссылке:

<http://moschip.ru/get-element>

Вы можете разместить у нас заказ для любого Вашего проекта, будь то серийное производство или разработка единичного прибора.

В нашем ассортименте представлены ведущие мировые производители активных и пассивных электронных компонентов.

Нашей специализацией является поставка электронной компонентной базы двойного назначения, продукции таких производителей как XILINX, Intel (ex.ALTERA), Vicor, Microchip, Texas Instruments, Analog Devices, Mini-Circuits, Amphenol, Glenair.

Сотрудничество с глобальными дистрибьюторами электронных компонентов, предоставляет возможность заказывать и получать с международных складов практически любой перечень компонентов в оптимальные для Вас сроки.

На всех этапах разработки и производства наши партнеры могут получить квалифицированную поддержку опытных инженеров.

Система менеджмента качества компании отвечает требованиям в соответствии с ГОСТ Р ИСО 9001, ГОСТ РВ 0015-002 и ЭС РД 009

Офис по работе с юридическими лицами:

105318, г.Москва, ул.Щербаковская д.3, офис 1107, 1118, ДЦ «Щербаковский»

Телефон: +7 495 668-12-70 (многоканальный)

Факс: +7 495 668-12-70 (доб.304)

E-mail: info@moschip.ru

Skype отдела продаж:

moschip.ru

moschip.ru_4

moschip.ru_6

moschip.ru_9