

ILONA-RS

~10° spot beam

TECHNICAL SPECIFICATIONS:

Dimensions	Ø 49.8 mm
Height	29.3 mm
Fastening	socket
ROHS compliant	yes ⓘ

MATERIAL SPECIFICATIONS:

Component	Type	Material	Colour	Finish
ILONA-RS	Single lens	PMMA	clear	



ORDERING INFORMATION:

Component	Qty in box	MOQ	MPQ	Box weight (kg)
C16686_ILONA-RS » Box size: 480 x 280 x 300 mm	297	33	33	10.8

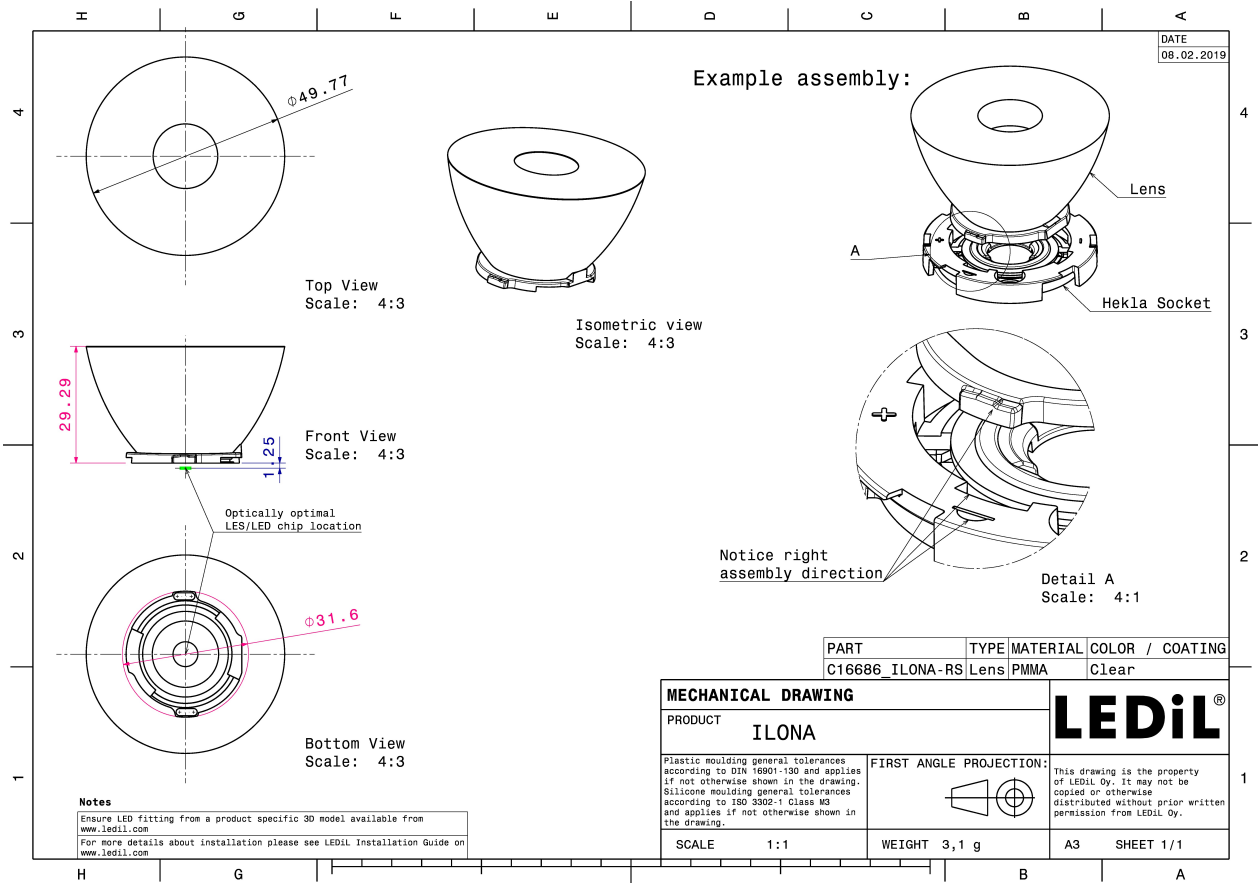

PHOTOMETRIC DATA (MEASURED):



LED Vesta DTW 9mm (4W/6W/12W)
 FWHM 19.0°
 Efficiency 93 %
 Peak intensity 6.5 cd/lm
 LEDs/each optic 1
 Light colour White
 Required components:
 C16142_HEKLA-SOCKET-K
 Bender Wirth: 490 Typ L8

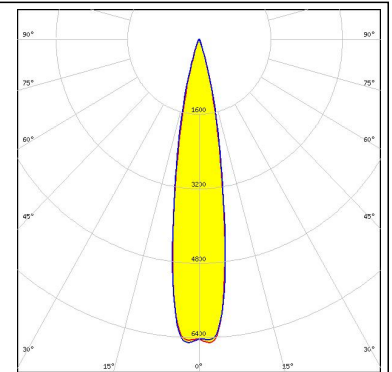
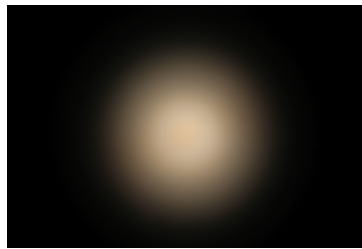

CITIZEN

LED CLU7A2 (LES 4.2mm)
 FWHM 9.0°
 Efficiency 94 %
 Peak intensity 26 cd/lm
 LEDs/each optic 1
 Light colour White
 Required components:
 F15255_HEKLA-SOCKET-C

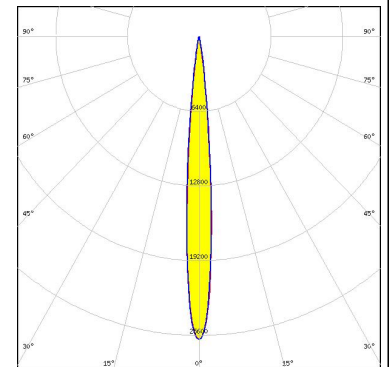
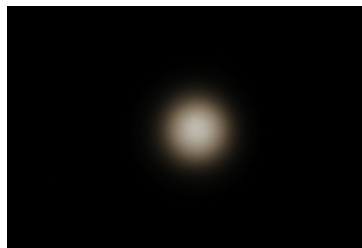

CITIZEN

LED CLU7B2
 FWHM 8.0°
 Efficiency 94 %
 Peak intensity 32.2 cd/lm
 LEDs/each optic 1
 Light colour White
 Required components:
 F15255_HEKLA-SOCKET-C

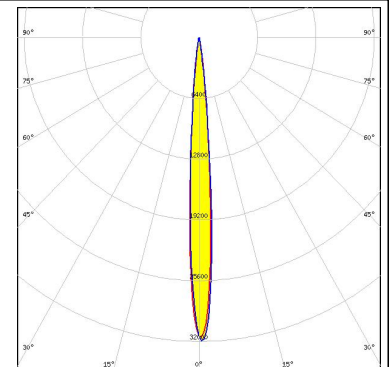
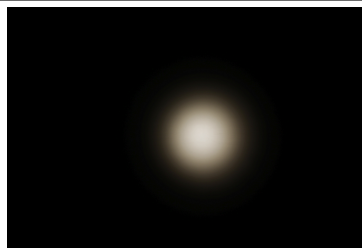

LED LUXEON CX Plus CoB - HD S01H4
 FWHM 12.0°
 Efficiency 94 %
 Peak intensity 16 cd/lm
 LEDs/each optic 1
 Light colour White
 Required components:
 Bender Wirth: 634c Hekla

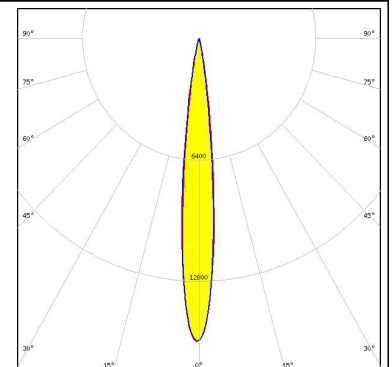

PHOTOMETRIC DATA (MEASURED):

LUMILEDS

LED LUXEON CX Plus CoB - HD S01H6 / HD S02H6
 FWHM 13.0°
 Efficiency 94 %
 Peak intensity 13.6 cd/Im
 LEDs/each optic 1
 Light colour White
 Required components:
 Bender Wirth: 634c Hekla

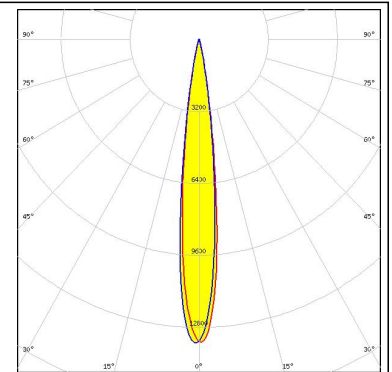
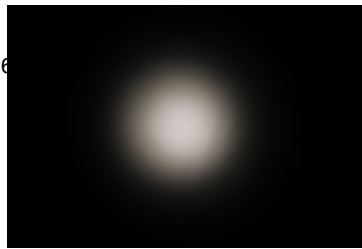

LUMILEDS

LED LUXEON CX Plus CoB - HD S04H9
 FWHM 19.0°
 Efficiency 94 %
 Peak intensity 7 cd/Im
 LEDs/each optic 1
 Light colour White
 Required components:
 Bender Wirth: 634c Hekla

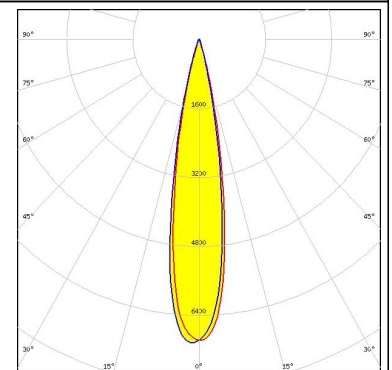

LUMINUS

LED CXM-3
 FWHM 9.0°
 Efficiency 94 %
 Peak intensity 31.3 cd/Im
 LEDs/each optic 1
 Light colour White
 Required components:
 F15255_HEKLA-SOCKET-C

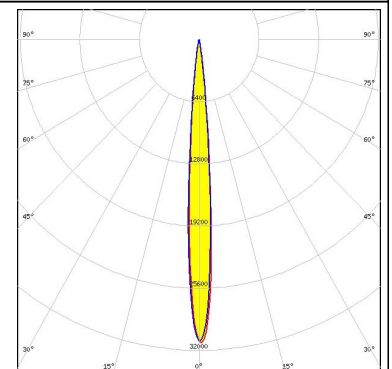
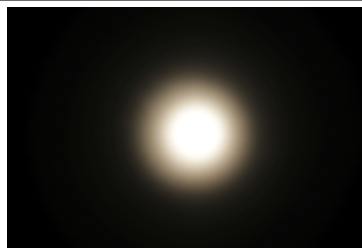

LUMINUS

LED CXM-4
 FWHM 10.0°
 Efficiency 94 %
 Peak intensity 21.9 cd/Im
 LEDs/each optic 1
 Light colour White
 Required components:
 F15255_HEKLA-SOCKET-C

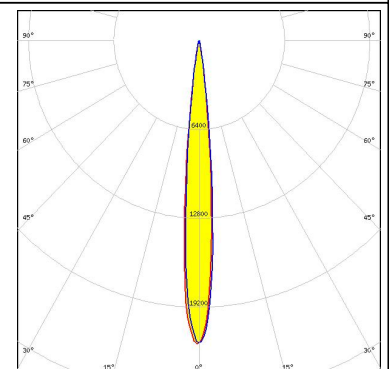

PHOTOMETRIC DATA (MEASURED):

OSRAM

Opto Semiconductors

LED OSTAR Stage (S2WN)
 FWHM 7.0°
 Efficiency 94 %
 Peak intensity 42.7 cd/lm
 LEDs/each optic 1
 Light colour White
 Required components:
 F15859_HEKLA-SOCKET-I

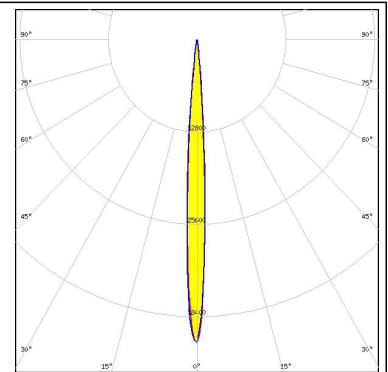
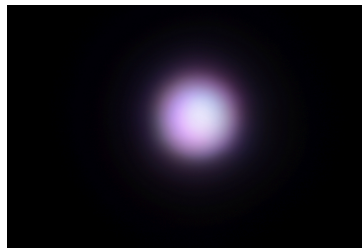

OSRAM

Opto Semiconductors

LED OSTAR Stage (S2WP)
 FWHM 9.0°
 Efficiency 94 %
 Peak intensity 29.2 cd/lm
 LEDs/each optic 1
 Light colour White
 Required components:
 F15859_HEKLA-SOCKET-I

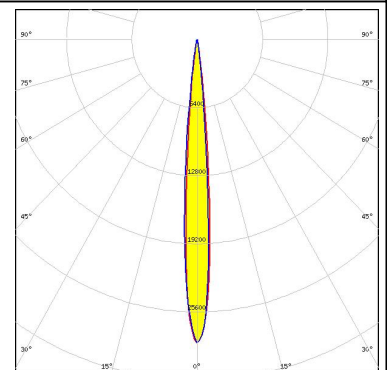
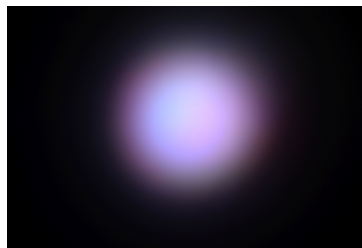

TRIDONIC

LED SLE G7 LES09
 FWHM 20.0°
 Efficiency 95 %
 Peak intensity 7.2 cd/lm
 LEDs/each optic 1
 Light colour White
 Required components:
 F15255_HEKLA-SOCKET-C

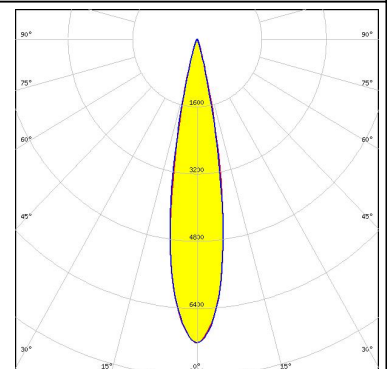

XICATO

LED XOB 6 mm
 FWHM 14.0°
 Efficiency 93 %
 Peak intensity 13.5 cd/lm
 LEDs/each optic 1
 Light colour White
 Required components:
 F15255_HEKLA-SOCKET-C

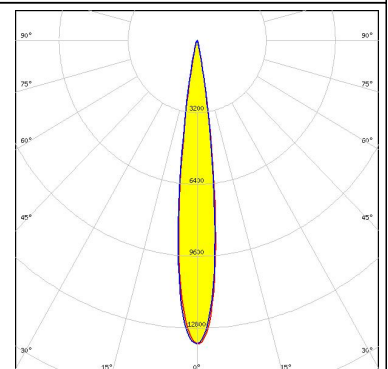

PHOTOMETRIC DATA (MEASURED):

XICATO

LED XOB 9.8 mm
FWHM 19.0°
Efficiency 94 %
Peak intensity 7.2 cd/lm
LEDs/each optic 1
Light colour White
Required components:
F15255_HEKLA-SOCKET-C

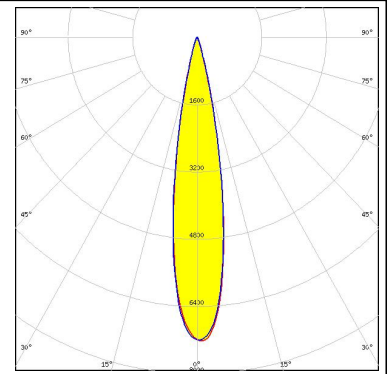

PHOTOMETRIC DATA (SIMULATED):

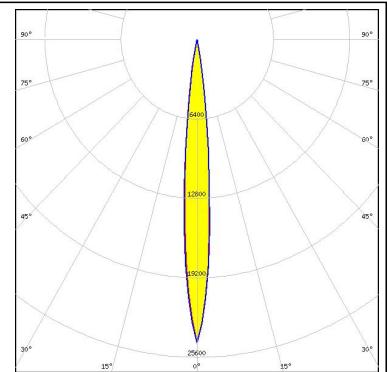
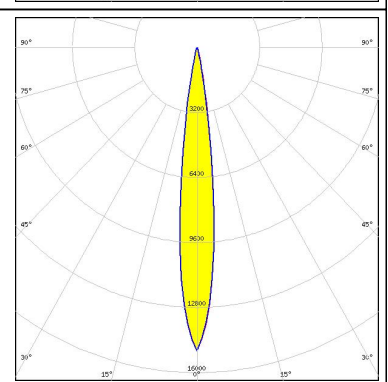
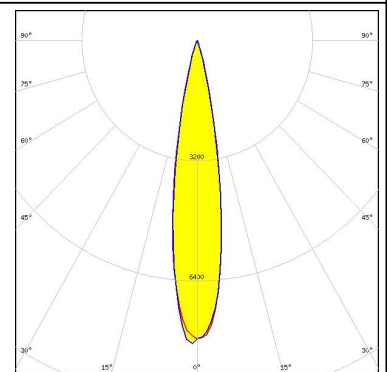
<p>bridgelux.</p> <p>LED V4 HD</p> <p>FWHM 10.0°</p> <p>Efficiency 95 %</p> <p>Peak intensity 24.4 cd/lm</p> <p>LEDs/each optic 1</p> <p>Light colour White</p> <p>Required components: FP15490_HEKLA-A</p>	
<p>bridgelux.</p> <p>LED V6 HD</p> <p>FWHM 12.0°</p> <p>Efficiency 94 %</p> <p>Peak intensity 14.9 cd/lm</p> <p>LEDs/each optic 1</p> <p>Light colour White</p> <p>Required components: F15255_HEKLA-SOCKET-C</p>	
<p>bridgelux.</p> <p>LED Vero SE 10</p> <p>FWHM 16.0°</p> <p>Efficiency 94 %</p> <p>Peak intensity 7.6 cd/lm</p> <p>LEDs/each optic 1</p> <p>Light colour White</p> <p>Required components:</p>	
<p>CITIZEN</p> <p>LED CLL02x/CLU02x (LES10)</p> <p>FWHM 18.0°</p> <p>Efficiency 93 %</p> <p>Peak intensity 8.1 cd/lm</p> <p>LEDs/each optic 1</p> <p>Light colour White</p> <p>Required components: FP15501_HEKLA-C</p>	

PHOTOMETRIC DATA (SIMULATED):

CITIZEN

LED CLU700/701/702
 FWHM 12.0°
 Efficiency 94 %
 Peak intensity 16.9 cd/lm
 LEDs/each optic 1
 Light colour White
 Required components:
 FP15501_HEKLA-C

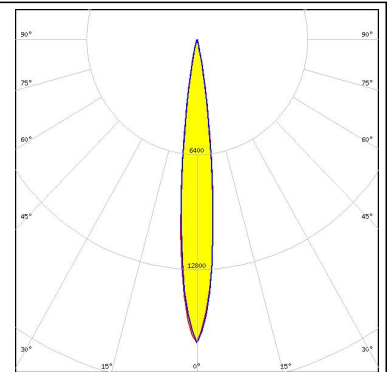

CITIZEN

LED CLU710/711
 FWHM 17.0°
 Efficiency 92 %
 Peak intensity 9.3 cd/lm
 LEDs/each optic 1
 Light colour White
 Required components:
 FP15949_HEKLA-I

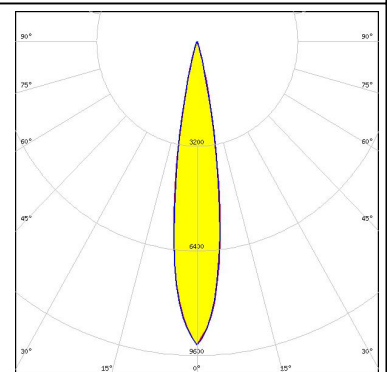

CREE

LED CXA/B 13xx
 FWHM 13.0°
 Efficiency 93 %
 Peak intensity 15 cd/lm
 LEDs/each optic 1
 Light colour White
 Required components:
 FP15957_HEKLA-J

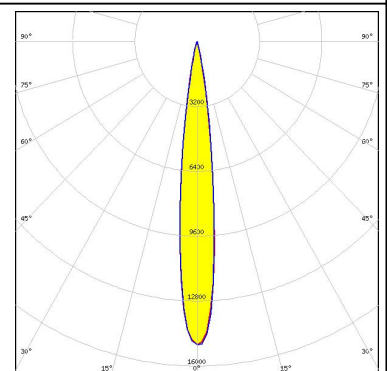

LUMILEDS

LED LUXEON CoB 1202s
 FWHM 12.0°
 Efficiency 95 %
 Peak intensity 15.6 cd/lm
 LEDs/each optic 1
 Light colour White
 Required components:
 F15858_HEKLA-SOCKET-H

PHOTOMETRIC DATA (SIMULATED):

LUMILEDS

LED LUXEON CoB 1204/1205
FWHM 26.0°
Efficiency 94 %
Peak intensity 3.9 cd/lm
LEDs/each optic 1
Light colour White
Required components:

LUMILEDS

LED LUXEON CoB 1208
FWHM 28.0°
Efficiency 91 %
Peak intensity 3.3 cd/lm
LEDs/each optic 1
Light colour White
Required components:

LUMILEDS

LED LUXEON CoB 1208
FWHM 27.0°
Efficiency 91 %
Peak intensity 3.2 cd/lm
LEDs/each optic 1
Light colour White
Required components:
C16142_HEKLA-SOCKET-K

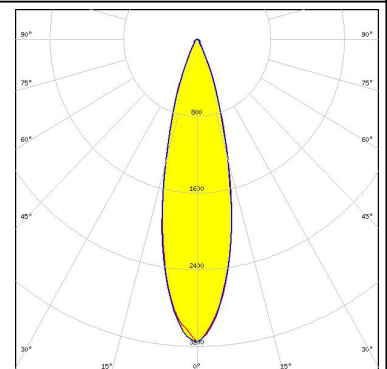

LUMINUS

LED CxM-6 (13.5x13.5)
FWHM 14.0°
Efficiency 94 %
Peak intensity 13.4 cd/lm
LEDs/each optic 1
Light colour White
Required components:
F15255_HEKLA-SOCKET-C

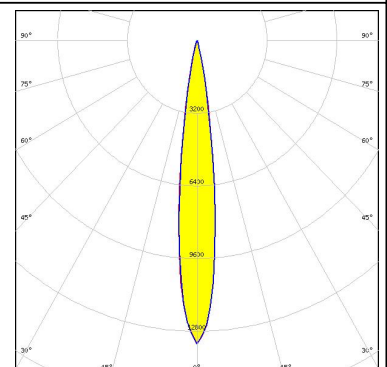

PHOTOMETRIC DATA (SIMULATED):

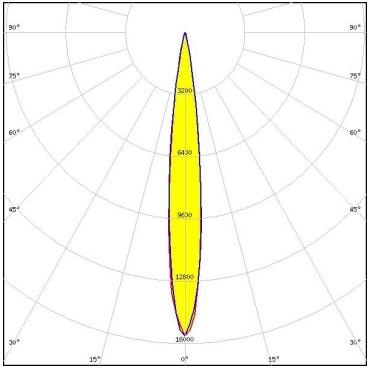
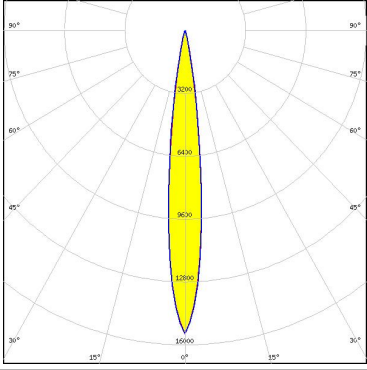
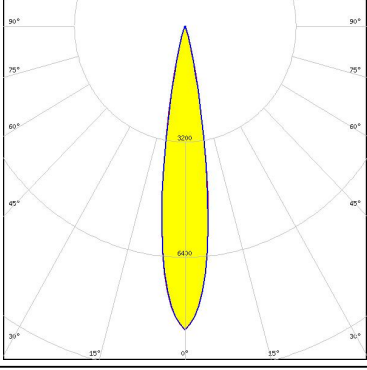
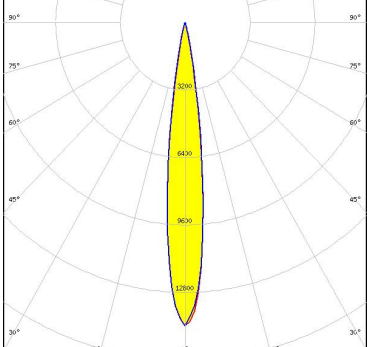
<p>NICHIA</p> <p>LED COB S-Type (LES 6) FWHM 12.0° Efficiency 93 % Peak intensity 15.6 cd/lm LEDs/each optic 1 Light colour White Required components: F15848_HEKLA-SOCKET-G</p>	
<p>NICHIA</p> <p>LED COB S-Type (LES 6) FWHM 12.0° Efficiency 93 % Peak intensity 15.4 cd/lm LEDs/each optic 1 Light colour White Required components: F15848_HEKLA-SOCKET-G</p>	
<p>NICHIA</p> <p>LED NFSWE11A FWHM 18.0° Efficiency 88 % Peak intensity 8.4 cd/lm LEDs/each optic 30 Light colour White Required components: C16142_HEKLA-SOCKET-K</p>	
<p>SAMSUNG</p> <p>LED LC010C FWHM 14.0° Efficiency 94 % Peak intensity 14.4 cd/lm LEDs/each optic 1 Light colour White Required components: FP15947_HEKLA-G</p>	

GENERAL INFORMATION:

NOTE: The typical beam angle will be changed by different color, chip size and chip position tolerance. The typical total beam angle is the full angle measured where the luminous intensity is half of the peak value.

Due to use of high power COB's with this product, special attention to proper thermal design is highly recommended. LEDiL has no liability for direct, indirect or consecutive damages arising from the LEDiL products being used outside of the recommended temperature range.

MATERIALS:

As part of our continuous research and improvement processes, and to ensure the best possible quality and availability of our products, LEDiL reserves the right to change material grades without notice.

PRODUCT DATA USER AGREEMENT AND DISCLAIMER:

The measured data in the provided downloadable LEDiL Product Datasheets and Mechanical 2D-Drawings is rounded and provided as reference for planning. LEDiL Oy's optical specifications have been verified by conducting performance testing of the products in accordance with the company's quality system. The reported data are averaged results of multiple measurements with typical variation. LEDiL Oy reserves the right to without prior notification make changes and improvements to its products.

LEDiL Oy assumes neither warranty, nor guarantee nor any other liability of any kind for the contents and correctness of the provided data. The provided data has been generated with highest diligence but the provided data may in reality not represent the complete possible variation range of all intrinsic parameters. Therefore, in certain cases a deviation from the provided data could occur.

LEDiL Oy reserves the right to undertake technical changes of its products without further notification which could lead to changes in the provided data. LEDiL Oy assumes no liability of any kind for the possible deviation from any provided data or any other damage resulting from the usage of the provided data.

The user agrees to this disclaimer and user agreement with the download or usage of the provided files.

LEDiL Oy

Joensuunkatu 13
FI-24240 SALO
Finland

LEDiL Inc.

228 West Page Street
Suite D
Sycamore IL 60178
USA

Local sales and technical support

[www.ledil.com/
where_to_buy](http://www.ledil.com/where_to_buy)

Shipping locations

Salo, Finland
Hong Kong, China

Distribution Partners

[www.ledil.com/
where_to_buy](http://www.ledil.com/where_to_buy)

Данный компонент на территории Российской Федерации

Вы можете приобрести в компании MosChip.

Для оперативного оформления запроса Вам необходимо перейти по данной ссылке:

<http://moschip.ru/get-element>

Вы можете разместить у нас заказ для любого Вашего проекта, будь то серийное производство или разработка единичного прибора.

В нашем ассортименте представлены ведущие мировые производители активных и пассивных электронных компонентов.

Нашей специализацией является поставка электронной компонентной базы двойного назначения, продукции таких производителей как XILINX, Intel (ex.ALTERA), Vicor, Microchip, Texas Instruments, Analog Devices, Mini-Circuits, Amphenol, Glenair.

Сотрудничество с глобальными дистрибьюторами электронных компонентов, предоставляет возможность заказывать и получать с международных складов практически любой перечень компонентов в оптимальные для Вас сроки.

На всех этапах разработки и производства наши партнеры могут получить квалифицированную поддержку опытных инженеров.

Система менеджмента качества компании отвечает требованиям в соответствии с ГОСТ Р ИСО 9001, ГОСТ РВ 0015-002 и ЭС РД 009

Офис по работе с юридическими лицами:

105318, г.Москва, ул.Щербаковская д.3, офис 1107, 1118, ДЦ «Щербаковский»

Телефон: +7 495 668-12-70 (многоканальный)

Факс: +7 495 668-12-70 (доб.304)

E-mail: info@moschip.ru

Skype отдела продаж:

moschip.ru

moschip.ru_4

moschip.ru_6

moschip.ru_9