

# Terminals, Kits and Tools

|                                       |     |                               |     |
|---------------------------------------|-----|-------------------------------|-----|
| Glossary of Terminals and Tools Terms | 48  |                               |     |
| Ring Tongues                          | 53  |                               |     |
| Multi-Stud Ring Tongues               | 78  |                               |     |
| Standard Forks                        | 79  |                               |     |
| Block Forks                           | 85  |                               |     |
| Flanged Block Forks                   | 93  |                               |     |
| Locking Forks                         | 98  |                               |     |
| Butt Connectors                       | 107 | Parallel Connectors           | 133 |
| Female Disconnects                    | 113 | Pin Terminals                 | 134 |
| Male Disconnects                      | 121 | 3M Highland™ Bagged Terminals | 135 |
| Flags                                 | 125 | Kits                          | 142 |
| Multi-Stack Disconnects               | 125 | Tools                         | 143 |
| Adapters                              | 126 | Terminal Stud Size Chart      | 146 |
| High Temperature                      | 128 | American Wire Gauge           | 146 |
| Closed End Connectors                 | 131 |                               |     |



For more than 30 years, 3M has been a leading supplier of Scotchlok terminals, disconnects, connectors and tools for high performance use in the assembly and maintenance of electrical systems. Thousands of satisfied customers know our products for:

- Effective and reliable performance, UL Listed and CSA Certified where appropriate.
- Variety of types, sizes and materials meeting a broad application range, including the demands of temperature and weather.

- Design features assuring easy installation of 3M products—positive and easy wire insertion, elimination of strand hang-ups and wire twisting, and easy insulation entry.

These are a few of the characteristics that make the installer's job easier.

## FREQUENTLY ASKED QUESTIONS

What does the insulation grip do?

The insulation grip provides a “second” crimp on the wire insulation providing additional wire strain relief. It's excellent for high vibration applications.

Which 3M tools can I use with 3M terminals?

The handy reference guide on pages 143-144 gives you a variety of choices of tools to use with 3M terminals.

What's the difference between insulated and fully insulated disconnects?

Insulated disconnects have barrel insulation only and fully insulated disconnects are insulated from the barrel to the receptacle/tab.

What temperatures do 3M terminals withstand?

Non-insulated 3M terminals withstand temperatures up to 347°F (175°C). Insulated 3M terminals withstand temperatures up to 221°F (105°C).

## Glossary of Terminals and Tools Terms

### ADAPTERS

To interconnect two connectors already attached to wires.

### BLOCK FORK

Same strength as the fork, but designed to use in terminal block because sides lie flat against barrier portion of terminal block.

### BULLET STYLE

Similar advantages as disconnects. Gives reliable in-line connection because parts are made to have holding friction when joined. Usually for automotive use.

### BUTT

Uses chamfered barrel ends to provide fast, easy wire insertion from both ends and a built-in wire stop for correct positioning. Must be crimped at both ends.

### CLOSED-END

Used in situations requiring pigtail of two or more wires.

### FLANGED FORK

Gives the benefit of both the block and locking forks. Stays secure should screw loosen.

### FORK

Allows rapid connection of wire. Usually used on free-standing studs, because of wider tongues.

### LOCKING FORK

The spring-like tongue locks in place around the stud even when mount screw is not tightened. Extra force is required to remove from stud.

### PARALLEL

Similar to butt with overlapped wires and single crimp in center of connector. Used where space is limited.

### PINS

For installation in compression blocks. Used in Europe for terminating stranded wire.

### QUICK CONNECT (DISCONNECT)

Attached to mating part by tongue of female part slipping over male tab. Use of dents and rolled edges on female part provides excellent holding force while allowing easy and quick disconnect.

### RING

The standard style of tongue. The safest and most reliable. It cannot be removed unless mounting screw is removed.

### TAB

Uses mounting hole for rivet or screw.

### TAP

No wire stripping is necessary, just lay wire in connector and crimp. Connection is made.

## Standard Terminal Construction

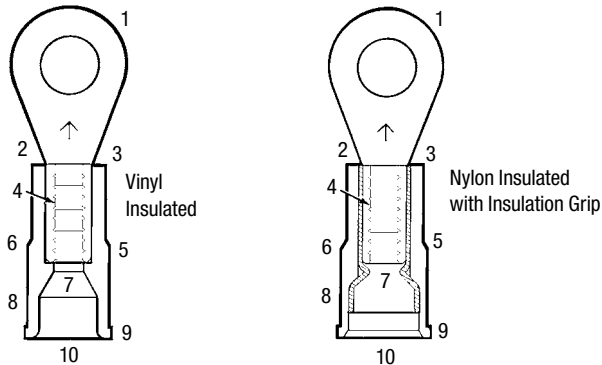

3M™ Terminals provide a variety of design features assuring consistently effective, reliable performance and easy installation.

Please refer to the illustrations at the numbered locations for the attributes described below.

1. One-piece, burr-free construction provides maximum electrical conductivity. Electrical bright-tin plating gives maximum corrosion resistance. Annealing relieves stress points and assures maximum installed strength.
2. Barrel-to-pad transition design minimizes flexing and bending.
3. Open-end design permits visual inspection of wire location before and after crimping.
4. Maximum hold on wire comes from multiple “V” grooves in #26–4 AWG parts resulting in excellent holding power.
5. Injection molded insulations on terminals are the highest quality in the industry.
  - 221°F (105°C) rated, tough, resistant electrical grade materials
  - Molding ensures consistent wall thickness for maximum reliability after crimping
  - Molding allows funnel barrel construction for easier installation
  - Molding offers the crimp ridge and non-slip ridge
6. Crimp ridge designed for positive location of tool on terminal barrel, resulting in few miscrimps.
7. Funnel barrel construction provides:
  - Positive, easy wire insertion
  - No hang-ups of wire strands
  - Wire twisting not necessary

8. Nylon-insulated terminals with grip feature a brass sleeve. Sleeve provides optimum grip on insulation, strain relief and vibration protection. Brass sleeve is recessed which provides excellent flash-over protection.

9. Non-slip ridge so tool slides to correct position for a proper crimp and better workmanship.

10. Beveled leading edge for easy wire insulation entry.

## Barrel Styles

### Non-Insulated Butted Seam

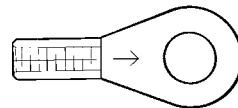

The most economical terminal—used where special performance or installation characteristics are not needed. Beveled mouth facilitates wire insertion. Maximum temperature for bare terminals: 347°F (175°C).

### Non-Insulated Brazed Seam

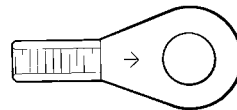

Beveled mouth facilitates wire insertion. Can be crimped anywhere on barrel surface. Silver brazed seam will not open under crimping pressure or operating stresses. Unlike butted seam parts, stranded wire cannot escape barrel confines during or after crimping. Maximum temperature for bare terminals: 347°F (175°C).

### Vinyl Insulated Brazed and Butted Seams

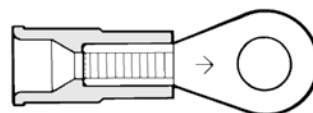

Used where insulated barrel is necessary and desirable. Terminal consists of brazed or butted part with flared, rigid molded polyvinyl chloride sleeve securely attached and funneled for easy wire entry. Wire insulation positions itself against funnel portion of vinyl sleeve thus eliminating strand hang-up. Crimping barrel and flared portion of sleeve provide excellent electrical contact plus mechanical stress relief at junction of insulation and barrel. Insulation has a non-slip ridge for ease of positioning crimping tool.

Industry standard color coding indicates wire range. Insulators are rated at a continuous operating temperature range from -40°F to 221°F (-40°C to 105°C).

UL Listed and CSA Certified for 600V building wire and 1000V signs and lighting fixtures (luminaries).

### Nylon Insulated Butted Seam with Insulation Grip

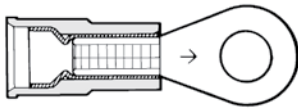

Used where insulated barrel and positive insulation grip are necessary or desirable. Terminal consists of butted seam part with flared, seamless brass sleeve securely attached and covered with flared, molded nylon sleeve. Wire insulation positions itself against funnel portion of brass sleeve. Crimping barrel and flared portion of sleeve provide excellent electrical contact plus mechanical stress relief at junction of insulation and barrel. Positioning crimp tool is nearly mistake proof due to a “step” in nylon insulation. Industry standard color coding indicates wire range. Insulators are rated at a continuous operating temperature range from -40°F to 221°F (-40°C to 105°C).

UL Listed and CSA Certified for 600V building wire and 1000V signs and lighting fixtures (luminaries).

### Installation Procedure

Funnel Barrel Feature provides an excellent electrical and mechanical connection.

- Funnel design guides wire into position.

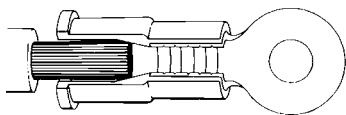

- No wire strand hang-up as the wire is inserted, giving a fast, positive installation.

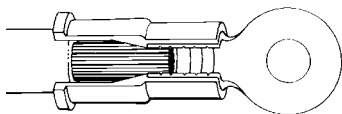

- Wire is in place, ready for crimping.

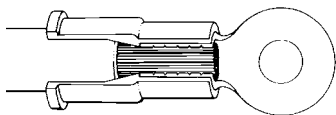

For maximum crimping performance, barrel of connector must be properly indexed in the crimp tool station.

## Correct crimping is important to assure a strong connection.

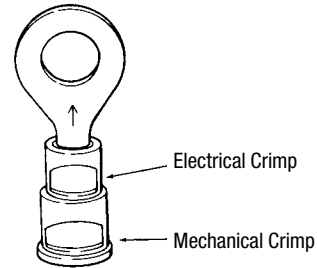

Insulated Terminals and Connectors:



### Non-Insulated Terminals and Connectors:

Indent should be opposite the barrel seam.

## Heat Shrink Terminals, Connectors and Disconnects

3M™ Heat Shrink pre-insulated terminals, connectors and disconnects protect against the most challenging of environments, making the best moisture protection available. They offer several advantages over conventional unsealed products.

### Corrosion Resistance

The adhesive-lined heat shrink material, when properly crimped and shrunk, provides a seal resistant to water, salt, steam and other related contaminants.

### Improved Mechanical Performance

The adhesive-lined heat shrink tubing adheres, when shrunk, to both the connector and the wire insulation providing improved pullout strength and strain relief.

### Durable Heat Shrink Tubing

Tough heat shrink tubing effectively resists abrasion, scoring, cut-through, and the effects of long-term aging.

### Versatile and Easy to Use

3M heat shrink terminals, splices and disconnects are available in wire sizes 22–10 AWG and can be installed easily with a recommended tool and heat source. The connectors are color-coded for wire range identification and the transparent tubing allows for visual inspection.

### Application Procedure for Heat Shrink Products:

1. Strip wires to appropriate length as indicated on package label.



2. Insert wire into terminal and crimp with correct station of a recommended tool.

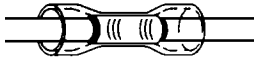

3. Apply heat with a recommended heat source.



## High Temperature Terminals and Connectors

3M high temperature terminals and connectors are constructed of steel with a nickel plating. Their temperature rating for continuous use at 900°F (482°C) makes them perfect for use in ovens, motors, light fixtures and other applications where other connectors would corrode or melt.

There is no applicable UL or CSA standard for high temperature steel parts.

## Standard Crimp Terminal and Connector Specifications

### Materials

Crimp terminals and connectors are to be burr-free, annealed and bright-tin plated ETP copper. Barrels shall be 0.25" long with brazed seams where specified. Insulation grip sleeves are to be tin-plated brass and attached securely to the barrel. Terminal insulators are to be molded polyvinyl chloride or nylon, UL Listed and CSA Certified for 600V in building wire and 1000V in signs and lighting fixtures (luminaries). Connector insulators are to be extruded polyvinyl chloride or nylon with a temperature rating of 221°F (105°C).

### Construction

All insulated terminals are to have funnel entry construction to prevent strand hang-up and a crimp ridge for proper tool location. Nylon insulated terminals and connectors are to have butted seam barrels with insulation grip sleeves. All terminal barrels are to have multiple "V" grooves for maximum conductor retention.

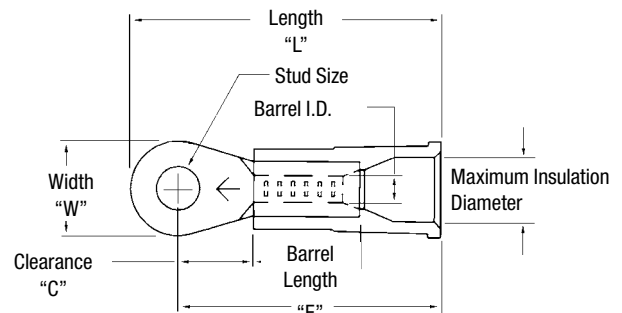

Note: All dimensions are measured in inches.

# 3M™ Terminal Numbering System

| 3M Identity | Code/Barrel Style   | Wire Size Code (AWG)  | – | Stud, Tab, or Bullet Size  | Tongue Code   | Product Availability**  |
|-------------|---|---|---|--|---|---|
| M           | No Code = Bare Brazed<br>A = No Barrel (adapter)<br>I = Double Wall w/interlock<br>N = Nylon Brazed<br>NG = Nylon w/ Grip<br>NHU = Nylon/Butted<br>w/ Heat Shrink Over Top<br>NU = Nylon/Butted<br>U = Bare/Butted<br>V = Vinyl/Brazed<br>VA = Vinyl Adapter<br>VU = Vinyl/Butted | 24 = 26–24 (yellow)<br>20 = 26–20 (yellow)<br>18 = 22–18 (red)<br>14 = 16–14 (blue)<br>10 = 12–10 (yellow)<br>8 = 8 (red)<br>6 = 6 (blue)<br>4 = 4 (yellow) | – | (STUD)<br>0 = 0<br>2 = 2<br>4 = 4<br>6 = 6<br>8 = 8<br>10 = 10<br>12 = 1/2"<br>14 = 1/4"<br>38 = 3/8"<br>516 = 5/16"<br>610 = 6, 8 10<br><br>(TAB)<br>110 = 0.110" x 0.020"<br>110/32 = 0.110" x 0.032"<br>187 = 0.187" x 0.020"<br>250 = 0.250" x 0.032"<br>375 = 0.375" x 0.050"<br><br>(BULLET)<br>156 = 0.156" Dia.<br>180 = 0.180" Dia.<br>47 = 0.47 pin length<br>55 = 0.55 pin length | F = Fork<br>FB = Fork, Block<br>FBHT = Fork, Block, High Temp.<br>FFB = Fork, Flanged, Block<br>FHT = Fork, High Temp.<br>FL = Fork, Locking<br>R = Ring<br>RHD = Ring, Heavy Duty<br>RHT = Ring, High Temp.<br>/S = Short or Small<br>/L = Large or Long<br>R/Flag = Ring, Flag<br>BC = Butt Connector<br>CEC = Closed End Connector<br>P = Pin Connector<br>PC = Parallel Connector<br>BCM = Butt Connector<br>Moisture Res.<br>CEC/ST = Closed End Connector,<br>Steel Insert<br>Disconnect<br>DF = Female<br>DFHT = Female, High Temp.<br>DFI = Female, Fully Insulated<br>DM = Male<br>DMF = Male, Female<br>DMHT = Male, High Temp.<br>DMI = Male, Fully Insulated<br>DF/Flag = Female Flag<br>Adapter<br>D = Disconnects<br>F = Female<br>FFI = Double Female, Fully Insulated<br>M = Male<br>MMI = Double Male, Fully Insulated<br>MMF = Double Male, Female<br>MFM = Male, Female, Male,<br>Stacking<br>RR = Ring Rectangular Tongue<br>Fuse = Fuse Adapter Clip | All box (X) package terminals in this catalog are available (in the packaging quantity indicated) from local distributor stocks. All bulk (K) packaged terminals are available in full cartons only, and may require a three to five week order lead time from the factory. |

\* A dash (–) separates the wire size code from the stud, tab or bullet size code.

\*\* Denotes product packaging. Packaging of 3M Scotchlok™ terminals should be specified by using the appropriate terminal part number. Suffix letters are indicated within each product number. (See “Product Number” heading in ordering information charts.)

Note: Contact your local distributor or 3M sales office for price and delivery information.

## Map of Numbering System

### Example:

Catalog Number: MNG18-4 FB/SK

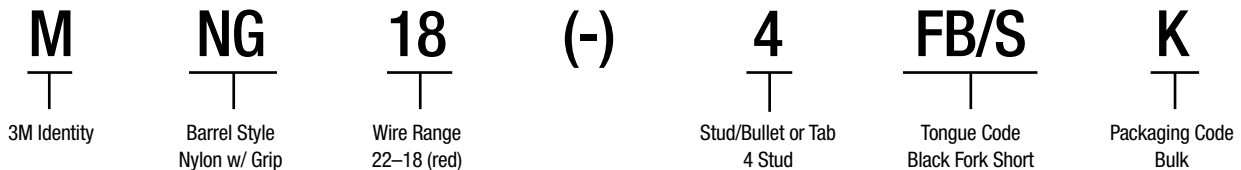

### Insulator Color Coding

Yellow (26-24 AWG)    Red (22-18 AWG)    Blue (16-14 AWG)    Yellow (12-10 AWG)    Red (8 AWG)    Blue (6 AWG)    Yellow (4 AWG)

\*Product number ending in X = box; product number ending with K = bulk.

# Ring Tongues

## 3M™ Ring Tongues — Non-Insulated Brazed Seam 22-18 AWG



| Product Number* | UPC (054007-) | Wire Range (AWG) | Stud Size | W    | C    | L    | E    | Thickness | Barrel Length | Barrel I.D. | Terminals per: Carton | Case |
|-----------------|---------------|------------------|-----------|------|------|------|------|-----------|---------------|-------------|-----------------------|------|
| M18-4R/SX       | 49590         | 22-18            | 4         | 0.25 | 0.22 | 0.60 | 0.47 | 0.030     | 0.25          | 0.070       | 100                   | 500  |
| M18-4R/SK       | 01014         | 22-18            | 4         | 0.25 | 0.22 | 0.60 | 0.47 | 0.030     | 0.25          | 0.070       | —                     | 1000 |
| M18-6R/SX       | 21635         | 22-18            | 6         | 0.25 | 0.22 | 0.60 | 0.47 | 0.030     | 0.25          | 0.070       | 100                   | 500  |
| M18-6R/SK       | 01016         | 22-18            | 6         | 0.25 | 0.22 | 0.60 | 0.47 | 0.030     | 0.25          | 0.070       | —                     | 1000 |
| M18-8R/LX       | 21643         | 22-18            | 8         | 0.31 | 0.33 | 0.74 | 0.58 | 0.030     | 0.25          | 0.070       | 100                   | 500  |
| M18-8R/LK       | 01021         | 22-18            | 8         | 0.31 | 0.33 | 0.74 | 0.58 | 0.030     | 0.25          | 0.070       | —                     | 1000 |
| M18-10R/LX      | 21650         | 22-18            | 10        | 0.31 | 0.33 | 0.74 | 0.58 | 0.030     | 0.25          | 0.070       | 100                   | 500  |
| M18-10R/LK      | 01023         | 22-18            | 10        | 0.31 | 0.33 | 0.74 | 0.58 | 0.030     | 0.25          | 0.070       | —                     | 1000 |
| M18-14R/SX      | 49591         | 22-18            | 1/4       | 0.47 | 0.40 | 0.89 | 0.65 | 0.030     | 0.25          | 0.070       | 100                   | 500  |
| M18-38RX        | 49593         | 22-18            | 3/8       | 0.56 | 0.40 | 0.93 | 0.65 | 0.030     | 0.25          | 0.070       | 100                   | 500  |

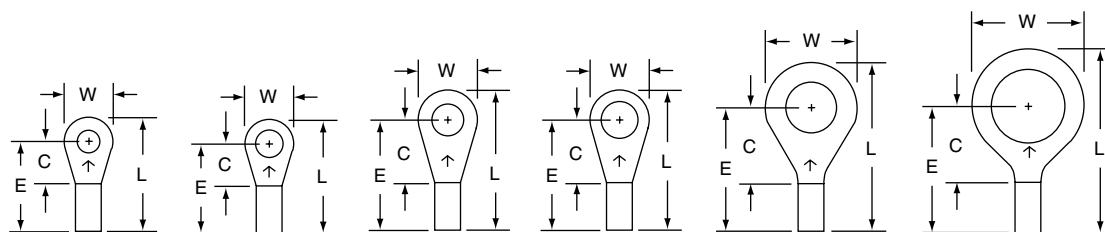

M18-4R/S      M18-6R/S      M18-8R/L      M18-10R/L      M18-14R/S      M18-38R

|            |       |       |       |       |       |       |
|------------|-------|-------|-------|-------|-------|-------|
| Stud Size  | 4     | 6     | 8     | 10    | 1/4   | 3/8   |
| Wire Range | 22-18 | 22-18 | 22-18 | 22-18 | 22-18 | 22-18 |

\*Product number ending in X = box; product number ending with K = bulk.

# 3M™ Ring Tongues — Non-Insulated Brazed Seam 16-14 AWG



| Product Number | UPC (054007-) | Wire Range (AWG) | Stud Size | W    | C    | L    | E    | Thickness | Barrel Length | Barrel I.D. | Terminals per Carton | Case |
|----------------|---------------|------------------|-----------|------|------|------|------|-----------|---------------|-------------|----------------------|------|
| M14-2R/SK      | 01379         | 16-14            | 2         | 0.25 | 0.22 | 0.60 | 0.47 | 0.030     | 0.25          | 0.090       | —                    | 1000 |
| M14-4R/SX      | 49612         | 16-14            | 4         | 0.25 | 0.22 | 0.60 | 0.47 | 0.030     | 0.25          | 0.090       | 100                  | 500  |
| M14-6R/SX      | 22294         | 16-14            | 6         | 0.25 | 0.22 | 0.60 | 0.47 | 0.030     | 0.25          | 0.090       | 100                  | 500  |
| M14-6R/SK      | 01382         | 16-14            | 6         | 0.25 | 0.22 | 0.60 | 0.47 | 0.030     | 0.25          | 0.090       | —                    | 1000 |
| M14-6R/LK      | 01384         | 16-14            | 6         | 0.31 | 0.33 | 0.74 | 0.58 | 0.030     | 0.25          | 0.090       | —                    | 1000 |
| M14-8R/LX      | 22302         | 16-14            | 8         | 0.31 | 0.33 | 0.74 | 0.58 | 0.030     | 0.25          | 0.090       | 100                  | 500  |
| M14-8R/LK      | 13880         | 16-14            | 8         | 0.31 | 0.33 | 0.74 | 0.58 | 0.030     | 0.25          | 0.090       | —                    | 1000 |
| M14-10RK       | 13929         | 16-14            | 10        | 0.33 | 0.29 | 0.70 | 0.54 | 0.030     | 0.25          | 0.090       | —                    | 1000 |
| M14-10R/LX     | 22310         | 16-14            | 10        | 0.31 | 0.33 | 0.74 | 0.58 | 0.030     | 0.25          | 0.090       | 100                  | 500  |
| M14-10R/LK     | 01389         | 16-14            | 10        | 0.31 | 0.33 | 0.74 | 0.58 | 0.030     | 0.25          | 0.090       | —                    | 1000 |
| M14-14R/SX     | 22328         | 16-14            | 1/4       | 0.47 | 0.40 | 0.89 | 0.65 | 0.030     | 0.25          | 0.090       | 100                  | 500  |
| M14-14R/SK     | 01390         | 16-14            | 1/4       | 0.47 | 0.40 | 0.89 | 0.65 | 0.030     | 0.25          | 0.090       | —                    | 1000 |
| M14-516R/SK    | 01392         | 16-14            | 5/16      | 0.47 | 0.40 | 0.89 | 0.65 | 0.030     | 0.25          | 0.090       | —                    | 1000 |
| M14-38RX       | 49614         | 16-14            | 3/8       | 0.56 | 0.40 | 0.93 | 0.65 | 0.030     | 0.25          | 0.090       | 100                  | 500  |

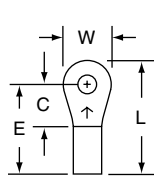

M14-2R/S

Stud Size

2

Wire Range

16-14

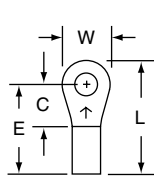

M14-4R/S

4

16-14

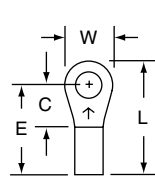

M14-6R/S

6

16-14

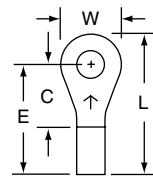

M14-6R/L

6

16-14

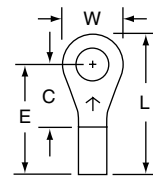

M14-8R/L

8

16-14

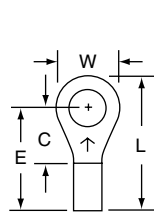

M14-10R

Stud Size

10

Wire Range

16-14

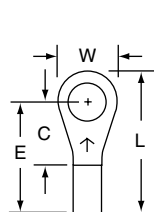

M14-10R/L

10

16-14

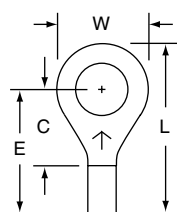

M14-14R/S

1/4

16-14

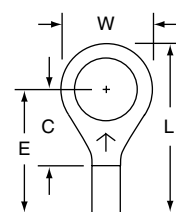

M14-516R/S

5/16

16-14

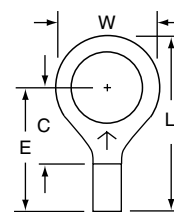

M14-38R

3/8

16-14

\*Product number ending in X = box; product number ending with K = bulk.



# 3M™ Ring Tongues — Non-Insulated Brazed Seam 12-10 AWG



| Product Number* | UPC (054007-) | Wire Range (AWG) | Stud Size | W    | C    | L    | E    | Thickness | Barrel Length | Barrel I.D. | Terminals per Carton | Case |
|-----------------|---------------|------------------|-----------|------|------|------|------|-----------|---------------|-------------|----------------------|------|
| M10-4R/SK       | 01890         | 12-10            | 4         | 0.28 | 0.29 | 0.68 | 0.54 | 0.040     | 0.25          | 0.135       | —                    | 500  |
| M10-6RX         | 23250         | 12-10            | 6         | 0.38 | 0.29 | 0.73 | 0.54 | 0.040     | 0.25          | 0.135       | 50                   | 500  |
| M10-6RK         | 01892         | 12-10            | 6         | 0.38 | 0.29 | 0.73 | 0.54 | 0.040     | 0.25          | 0.135       | —                    | 500  |
| M10-8RX         | 23268         | 12-10            | 8         | 0.38 | 0.29 | 0.73 | 0.54 | 0.040     | 0.25          | 0.135       | 50                   | 500  |
| M10-8RK         | 01894         | 12-10            | 8         | 0.38 | 0.29 | 0.73 | 0.54 | 0.040     | 0.25          | 0.135       | —                    | 500  |
| M10-10RX        | 23276         | 12-10            | 10        | 0.38 | 0.29 | 0.73 | 0.54 | 0.040     | 0.25          | 0.135       | 50                   | 500  |
| M10-10RK        | 14002         | 12-10            | 10        | 0.38 | 0.29 | 0.73 | 0.54 | 0.040     | 0.25          | 0.135       | —                    | 500  |
| M10-14R/SX      | 23284         | 12-10            | 1/4       | 0.54 | 0.44 | 0.96 | 0.69 | 0.040     | 0.25          | 0.135       | 50                   | 500  |
| M10-14R/SK      | 01896         | 12-10            | 1/4       | 0.54 | 0.44 | 0.96 | 0.69 | 0.040     | 0.25          | 0.135       | —                    | 500  |
| M10-516R/SX     | 49637         | 12-10            | 5/16      | 0.54 | 0.44 | 0.96 | 0.69 | 0.040     | 0.25          | 0.135       | 50                   | 500  |
| M10-38R/SX      | 49638         | 12-10            | 3/8       | 0.54 | 0.44 | 0.96 | 0.69 | 0.040     | 0.25          | 0.135       | 50                   | 500  |
| M10-38R/SK      | 01900         | 12-10            | 3/8       | 0.54 | 0.44 | 0.96 | 0.69 | 0.040     | 0.25          | 0.135       | —                    | 500  |
| M10-12RK        | 01903         | 12-10            | 1/2       | 0.75 | 0.57 | 1.19 | 0.82 | 0.040     | 0.25          | 0.135       | —                    | 500  |

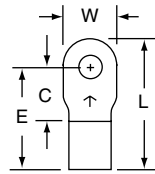

M10-4R/S

Stud Size

4

Wire Range

12-10

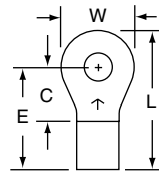

M10-6R

6

12-10

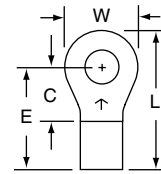

M10-8R

8

12-10

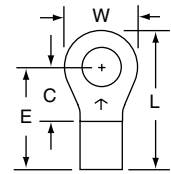

M10-10R

10

12-10

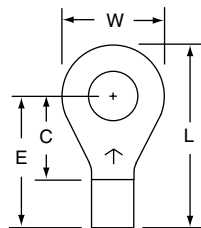

M10-14R/S

Stud Size

1/4

Wire Range

12-10

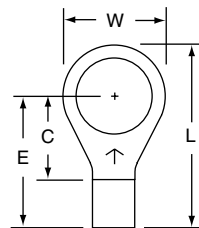

M10-516R/S

5/16

12-10

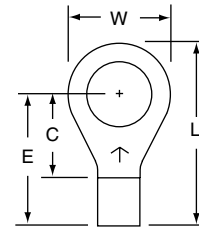

M10-38R/S

3/8

12-10

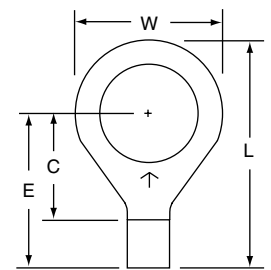

M10-12R

1/2

12-10

\*Product number ending in X = box; product number ending with K = bulk.

# 3M™ Ring Tongues — Non-Insulated Brazed Seam 8 AWG



| Product Number* | UPC (054007-) | Wire Range (AWG) | Stud Size | W    | C    | L    | E    | Thickness | Barrel Length | Barrel I.D. | Terminals per Carton | Case |
|-----------------|---------------|------------------|-----------|------|------|------|------|-----------|---------------|-------------|----------------------|------|
| M8-10R/SX       | 24118         | 8                | 10        | 0.47 | 0.40 | 0.95 | 0.72 | 0.050     | 0.31          | 0.175       | 25                   | 250  |
| M8-10R/SK       | 02118         | 8                | 10        | 0.47 | 0.40 | 0.95 | 0.72 | 0.050     | 0.31          | 0.175       | —                    | 200  |
| M8-14R/SX       | 24126         | 8                | 1/4       | 0.47 | 0.40 | 0.95 | 0.72 | 0.050     | 0.31          | 0.175       | 25                   | 250  |
| M8-516RX        | 24134         | 8                | 5/16      | 0.59 | 0.45 | 1.06 | 0.77 | 0.050     | 0.31          | 0.175       | 25                   | 250  |
| M8-516RK        | 02122         | 8                | 5/16      | 0.59 | 0.45 | 1.06 | 0.77 | 0.050     | 0.31          | 0.175       | —                    | 200  |
| M8-38RX         | 24142         | 8                | 3/8       | 0.59 | 0.45 | 1.06 | 0.77 | 0.050     | 0.31          | 0.175       | 25                   | 250  |
| M8-38RK         | 02123         | 8                | 3/8       | 0.59 | 0.45 | 1.06 | 0.77 | 0.050     | 0.31          | 0.175       | —                    | 200  |
| M8-12R/SK       | 02126         | 8                | 1/2       | 0.81 | 0.69 | 1.41 | 1.00 | 0.050     | 0.31          | 0.175       | —                    | 200  |

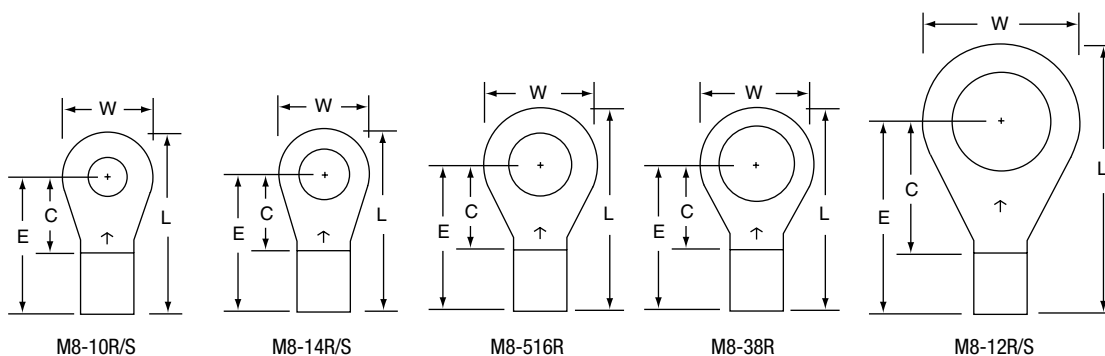

|            | M8-10R/S | M8-14R/S | M8-516R | M8-38R | M8-12R/S |
|------------|----------|----------|---------|--------|----------|
| Stud Size  | 10       | 1/4      | 5/16    | 3/8    | 1/2      |
| Wire Range | 8        | 8        | 8       | 8      | 8        |

\*Product number ending in X = box; product number ending with K = bulk.

# 3M™ Ring Tongues — Non-Insulated Brazed Seam 6 AWG



| Product Number* | UPC (054007-) | Wire Range (AWG) | Stud Size | W    | C    | L    | E    | Thickness | Barrel Length | Barrel I.D. | Terminals per Carton | Terminals per Case |
|-----------------|---------------|------------------|-----------|------|------|------|------|-----------|---------------|-------------|----------------------|--------------------|
| M6-10R/SX       | 24175         | 6                | 10        | 0.47 | 0.52 | 1.14 | 0.91 | 0.050     | 0.39          | 0.250       | 20                   | 200                |
| M6-10R/SK       | 02147         | 6                | 10        | 0.47 | 0.52 | 1.14 | 0.91 | 0.050     | 0.39          | 0.250       | —                    | 200                |
| M6-14R/SX       | 24183         | 6                | 1/4       | 0.47 | 0.52 | 1.14 | 0.91 | 0.050     | 0.39          | 0.250       | 20                   | 200                |
| M6-14R/SK       | 02149         | 6                | 1/4       | 0.47 | 0.52 | 1.14 | 0.91 | 0.050     | 0.39          | 0.250       | —                    | 200                |
| M6-516RX        | 24191         | 6                | 5/16      | 0.63 | 0.52 | 1.22 | 0.91 | 0.050     | 0.39          | 0.250       | 20                   | 200                |
| M6-516RK        | 02151         | 6                | 5/16      | 0.63 | 0.52 | 1.22 | 0.91 | 0.050     | 0.39          | 0.250       | —                    | 200                |
| M6-38RX         | 24209         | 6                | 3/8       | 0.63 | 0.52 | 1.22 | 0.91 | 0.050     | 0.39          | 0.250       | 20                   | 200                |
| M6-38RK         | 02152         | 6                | 3/8       | 0.63 | 0.52 | 1.22 | 0.91 | 0.050     | 0.39          | 0.250       | —                    | 200                |
| M6-12R/SK       | 02155         | 6                | 1/2       | 0.81 | 0.63 | 1.42 | 1.02 | 0.050     | 0.39          | 0.250       | —                    | 200                |

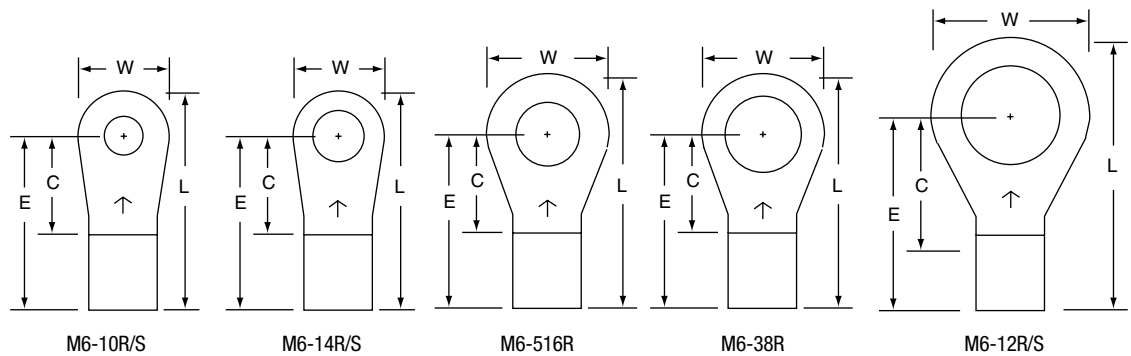

|            |    |     |      |     |     |
|------------|----|-----|------|-----|-----|
| Stud Size  | 10 | 1/4 | 5/16 | 3/8 | 1/2 |
| Wire Range | 6  | 6   | 6    | 6   | 6   |

\*Product number ending in X = box; product number ending with K = bulk.

# 3M™ Ring Tongues — Non-Insulated Brazed Seam 4 AWG



| Product Number* | UPC (054007-) | Wire Range (AWG) | Stud Size | W    | C    | L    | E    | Thickness | Barrel Length | Barrel I.D. | Terminals per Carton | Case |
|-----------------|---------------|------------------|-----------|------|------|------|------|-----------|---------------|-------------|----------------------|------|
| M4-10RX         | 49648         | 4                | 10        | 0.68 | 0.53 | 1.34 | 1.00 | 0.075     | 0.47          | 0.280       | 20                   | 200  |
| M4-10RK         | 02176         | 4                | 10        | 0.68 | 0.53 | 1.34 | 1.00 | 0.075     | 0.47          | 0.280       | —                    | 200  |
| M4-14RX         | 24241         | 4                | 1/4       | 0.68 | 0.53 | 1.34 | 1.00 | 0.075     | 0.47          | 0.280       | 20                   | 200  |
| M4-14RK         | 02177         | 4                | 1/4       | 0.68 | 0.53 | 1.34 | 1.00 | 0.075     | 0.47          | 0.280       | —                    | 200  |
| M4-516RX        | 24258         | 4                | 5/16      | 0.68 | 0.53 | 1.34 | 1.00 | 0.075     | 0.47          | 0.280       | 20                   | 200  |
| M4-516RK        | 02178         | 4                | 5/16      | 0.68 | 0.53 | 1.34 | 1.00 | 0.075     | 0.47          | 0.280       | —                    | 200  |
| M4-38RX         | 24266         | 4                | 3/8       | 0.68 | 0.53 | 1.34 | 1.00 | 0.075     | 0.47          | 0.280       | 20                   | 200  |
| M4-38RK         | 02179         | 4                | 3/8       | 0.68 | 0.53 | 1.34 | 1.00 | 0.075     | 0.47          | 0.280       | —                    | 200  |
| M4-12R/SK       | 02182         | 4                | 1/2       | 0.68 | 0.53 | 1.34 | 1.00 | 0.075     | 0.47          | 0.280       | —                    | 200  |

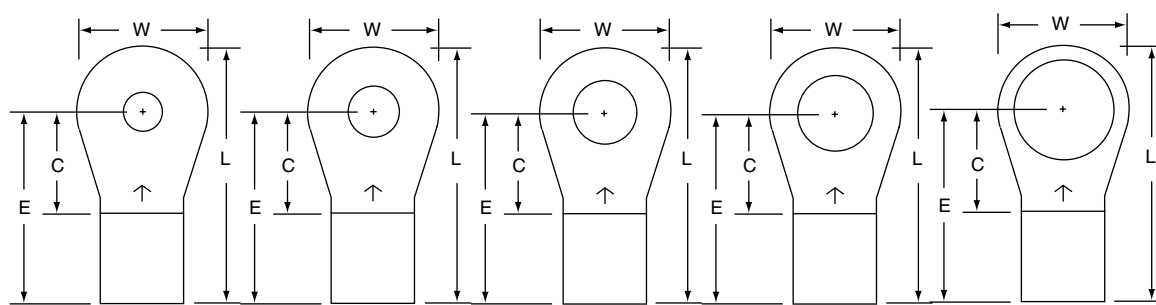

M4-10R

M4-14R

M4-516R

M4-38R

M4-12R/S

Stud Size  
Wire Range

10

4

1/4

4

5/16

4

3/8

4

1/2

4

\*Product number ending in X = box; product number ending with K = bulk.

# 3M™ Large Gauge Ring Tongues — Non-Insulated Copper Seamless 2 AWG



| Product Number* | UPC (054007-) | Color Code | Wire Range (AWG) | Stud Size             | W         | C         | L         | Thickness | Barrel I.D. | Inner Unit Pack | Case Qty. |
|-----------------|---------------|------------|------------------|-----------------------|-----------|-----------|-----------|-----------|-------------|-----------------|-----------|
| MC2-14RX        | 09187         | Brown      | 2 AWG            | 1/4"                  | 0.65"     | 0.41"     | 1.69"     | 0.10"     | 0.34"       | 10/box          | 100       |
|                 |               |            |                  | (6 mm <sup>2</sup> )  | (16,5 mm) | (10,4 mm) | (42,9 mm) | (2,5 mm)  | (8,6 mm)    |                 |           |
| MC2-516RX       | 09188         | Brown      | 2 AWG            | 5/16"                 | 0.65"     | 0.41"     | 1.69"     | 0.10"     | 0.34"       | 10/box          | 100       |
|                 |               |            |                  | (8 mm <sup>2</sup> )  | (16,5 mm) | (10,4 mm) | (42,9 mm) | (2,5 mm)  | (8,6 mm)    |                 |           |
| MC2-38RX        | 09189         | Brown      | 2 AWG            | 3/8"                  | 0.65"     | 0.41"     | 1.69"     | 0.10"     | 0.34"       | 10/box          | 100       |
|                 |               |            |                  | (10 mm <sup>2</sup> ) | (16,5 mm) | (10,4 mm) | (42,9 mm) | (2,5 mm)  | (8,6 mm)    |                 |           |

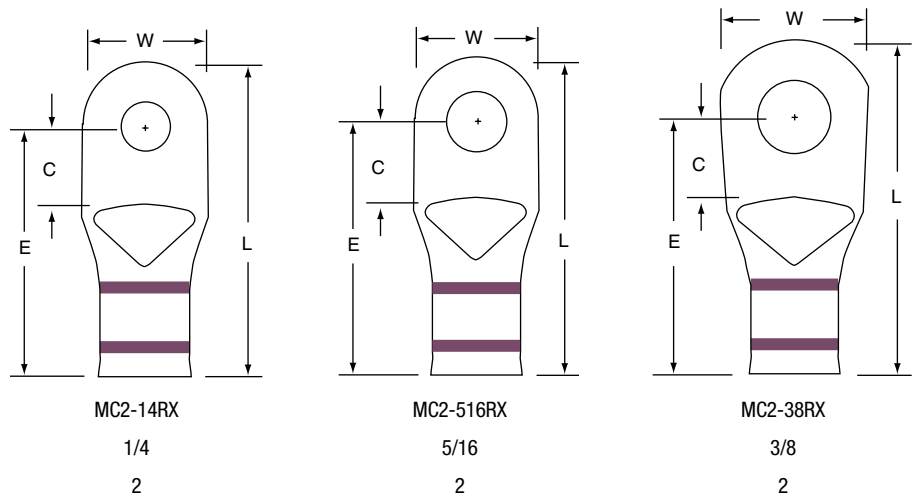

\*Product number ending in X = box; product number ending with K = bulk.

# 3M™ Large Gauge Ring Tongues — Non-Insulated Copper Seamless 1 AWG



| Product Number* | UPC (054007-) | Color Code | Wire Range (AWG) | Stud Size             | W         | C         | L         | Thickness | Barrel I.D. | Inner Unit Pack | Case Qty. |
|-----------------|---------------|------------|------------------|-----------------------|-----------|-----------|-----------|-----------|-------------|-----------------|-----------|
| MC1-14RX        | 09190         | Green      | 1 AWG            | 1/4"                  | 0.65"     | 0.43"     | 1.71"     | 0.10"     | 0.36"       | 10/box          | 100       |
|                 |               |            |                  | (6 mm <sup>2</sup> )  | (16,5 mm) | (10,9 mm) | (43,4 mm) | (2,5 mm)  | (9,1 mm)    |                 |           |
| MC1-516RX       | 09191         | Green      | 1 AWG            | 5/16"                 | 0.65"     | 0.43"     | 1.71"     | 0.10"     | 0.36"       | 10/box          | 100       |
|                 |               |            |                  | (8 mm <sup>2</sup> )  | (16,5 mm) | (10,9 mm) | (43,4 mm) | (2,5 mm)  | (9,1 mm)    |                 |           |
| MC1-38RX        | 09192         | Green      | 1 AWG            | 3/8"                  | 0.68"     | 0.43"     | 1.71"     | 0.10"     | 0.36"       | 10/box          | 100       |
|                 |               |            |                  | (10 mm <sup>2</sup> ) | (17,3 mm) | (10,9 mm) | (43,4 mm) | (2,5 mm)  | (9,1 mm)    |                 |           |

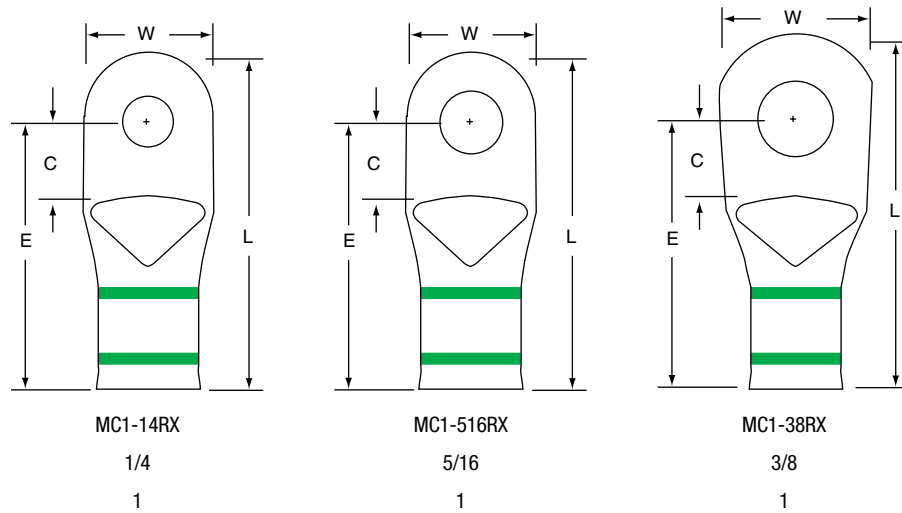

\*Product number ending in X = box; product number ending with K = bulk.



# 3M™ Large Gauge Ring Tongues — Non-Insulated Copper Seamless 1/0 AWG Ⓢ Ⓞ

| Product Number* | UPC (054007-) | Color Code | Wire Range (AWG) | Stud Size | W         | C         | L         | Thickness | Barrel I.D. | Inner Unit Pack | Case Qty. |
|-----------------|---------------|------------|------------------|-----------|-----------|-----------|-----------|-----------|-------------|-----------------|-----------|
| MC1/0-14RX      | 09193         | Pink       | 1/0 AWG          | 1/4"      | 0.75"     | 0.38"     | 1.84"     | 0.10"     | 0.41"       | 10/box          | 100       |
|                 |               |            |                  | (6 mm)    | (19,0 mm) | (9,7 mm)  | (46,7 mm) | (2,5 mm)  | (10,4 mm)   |                 |           |
| MC1/0-38RX      | 09194         | Pink       | 1/0 AWG          | 3/8"      | 0.75"     | 0.42"     | 1.84"     | 0.10"     | 0.41"       | 10/box          | 100       |
|                 |               |            |                  | (8 mm)    | (19,0 mm) | (10,7 mm) | (46,7 mm) | (2,5 mm)  | (10,4 mm)   |                 |           |
| MC1/0-12RX      | 09195         | Pink       | 1/0 AWG          | 1/2"      | 0.75"     | 0.42"     | 1.84"     | 0.10"     | 0.41"       | 10/box          | 100       |
|                 |               |            |                  | (12 mm)   | (19,0 mm) | (10,7 mm) | (46,7 mm) | (2,5 mm)  | (10,4 mm)   |                 |           |

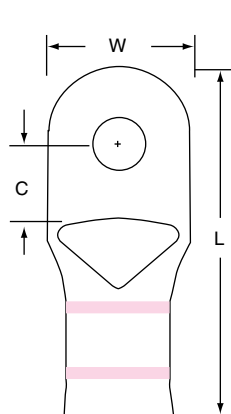

MC1/0-14RX

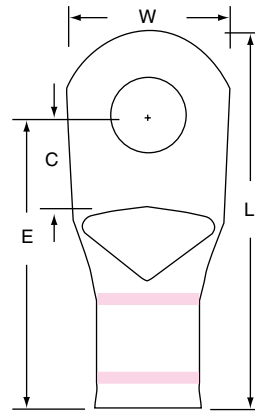

MC1/0-38RX

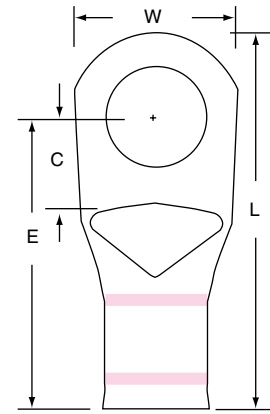

MC1/0-12RX

Stud Size  
Wire Range

1/4  
1/0

3/8  
1/0

1/2  
1/0

\*Product number ending in X = box; product number ending with K = bulk.

## 3M™ Large Gauge Ring Tongues — Non-Insulated Copper Seamless 2/0 AWG Ⓢ Ⓞ

| Product Number | UPC (054007-) | Color Code | Wire Range (AWG) | Stud Size | W         | C         | L         | Thickness | Barrel I.D. | Inner Unit Pack | Case Qty. |
|----------------|---------------|------------|------------------|-----------|-----------|-----------|-----------|-----------|-------------|-----------------|-----------|
| MC2/0-38RX     | 09197         | Black      | 2/0 AWG          | 3/8"      | 0.83"     | 0.48"     | 2.05"     | 0.10"     | 0.46"       | 10/box          | 100       |
|                |               |            |                  | (10 mm)   | (21,1 mm) | (12,2 mm) | (52,1 mm) | (2,5 mm)  | (11,7 mm)   |                 |           |
| MC2/0-12RX     | 09198         | Black      | 2/0 AWG          | 1/2"      | 0.83"     | 0.48"     | 2.05"     | 0.10"     | 0.46"       | 10/box          | 100       |
|                |               |            |                  | (12 mm)   | (21,1 mm) | (12,2 mm) | (52,1 mm) | (2,5 mm)  | (11,7 mm)   |                 |           |

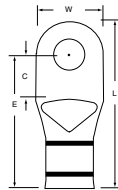

MC2/0-38RX

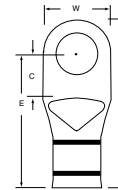

MC2/0-12RX

Stud Size  
Wire Range

3/8  
2/0

1/2  
2/0

## 3M™ Large Gauge Ring Tongues — Non-Insulated Copper Seamless 3/0 AWG Ⓢ Ⓞ

| Product Number | UPC (054007-) | Color Code | Wire Range (AWG) | Stud Size | W         | C         | L         | Thickness | Barrel I.D. | Inner Unit Pack | Case Qty. |
|----------------|---------------|------------|------------------|-----------|-----------|-----------|-----------|-----------|-------------|-----------------|-----------|
| MC3/0-38RX     | 09199         | Orange     | 3/0 AWG          | 3/8"      | 0.91"     | 0.50"     | 2.24"     | 0.12"     | 0.51"       | 6/box           | 60        |
|                |               |            |                  | (10 mm)   | (23,1 mm) | (12,7 mm) | (56,9 mm) | (3,1 mm)  | (13,0 mm)   |                 |           |
| MC3/0-12RX     | 09200         | Orange     | 3/0 AWG          | 1/2"      | 0.91"     | 0.50"     | 2.24"     | 0.12"     | 0.51"       | 6/box           | 60        |
|                |               |            |                  | (12 mm)   | (23,1 mm) | (12,7 mm) | (56,9 mm) | (3,1 mm)  | (13,0 mm)   |                 |           |

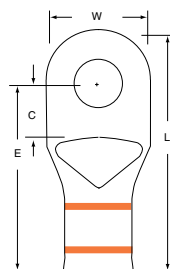

MC3/0-38RX

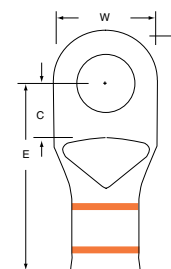

MC3/0-12RX

Stud Size  
Wire Range

3/8  
3/0

1/2  
3/0

Product number ending in X = box; product number ending with K = bulk.



## 3M™ Large Gauge Ring Tongues — Non-Insulated Copper Seamless 4/0 AWG-250 kcmil



| Product Number* | UPC (054007-) | Color Code | Wire Range (AWG) | Stud Size | W         | C         | L         | Thickness | Barrel I.D. | Inner Unit Pack | Case Qty. |
|-----------------|---------------|------------|------------------|-----------|-----------|-----------|-----------|-----------|-------------|-----------------|-----------|
| MC4/0-38RX      | 09201         | Purple     | 4/0 AWG          | 3/8"      | 1.00"     | 0.52"     | 2.29"     | 0.125"    | 0.56"       | 6/box           | 60        |
|                 |               |            |                  | (10 mm)   | (25,4 mm) | (13,2 mm) | (58,2 mm) | (3,2 mm)  | (14,2 mm)   |                 |           |
| MC4/0-12RX      | 09202         | Purple     | 4/0 AWG          | 1/2"      | 1.00"     | 0.52"     | 2.29"     | 0.125"    | 0.56"       | 6/box           | 60        |
|                 |               |            |                  | (12 mm)   | (25,4 mm) | (13,2 mm) | (58,2 mm) | (3,2 mm)  | (14,2 mm)   |                 |           |
| MC250-38RX      | 09203         | Yellow     | 250 kcmil        | 3/8"      | 1.13"     | 0.60"     | 2.43"     | 0.14"     | 0.63"       | 6/box           | 60        |
|                 |               |            |                  | (10 mm)   | (28,7 mm) | (15,2 mm) | (61,7 mm) | (3,6 mm)  | (16,0 mm)   |                 |           |
| MC250-12RX      | 09204         | Yellow     | 250 kcmil        | 1/2"      | 1.13"     | 0.60"     | 2.43"     | 0.14"     | 0.63"       | 6/box           | 60        |
|                 |               |            |                  | (12 mm)   | (28,7 mm) | (15,2 mm) | (61,7 mm) | (3,6 mm)  | (16,0 mm)   |                 |           |

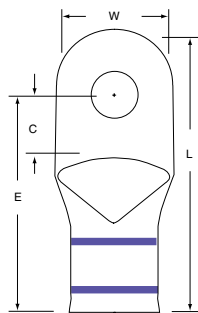

MC4/0-38RX

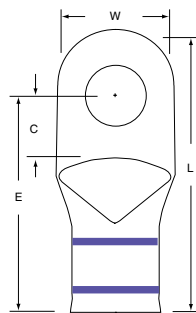

MC4/0-12RX

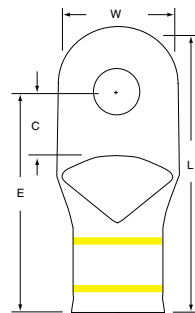

MC250-38RX

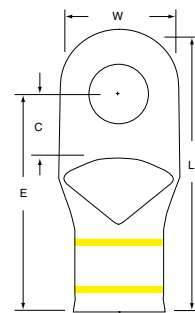

MC250-12RX

|            |     |     |             |             |
|------------|-----|-----|-------------|-------------|
| Stud Size  | 3/8 | 1/2 | 3/8         | 1/2         |
| Wire Range | 4/0 | 4/0 | 250 (kcmil) | 250 (kcmil) |

## 3M™ Ring Tongues — Non-Insulated Butted Seam 26-24 AWG

| Product Number* | UPC (054007-) | Wire Range (AWG) | Stud Size | W    | C    | L    | E    | Thickness | Barrel Length | Barrel I.D. | Terminals per Case |
|-----------------|---------------|------------------|-----------|------|------|------|------|-----------|---------------|-------------|--------------------|
| MU24-2RK        | 00958         | 26-24            | 2         | 0.14 | 0.12 | 0.31 | 0.24 | 0.020     | 0.13          | 0.030       | 1000               |
| MU24-4RK        | 00959         | 26-24            | 4         | 0.20 | 0.21 | 0.45 | 0.35 | 0.020     | 0.14          | 0.030       | 1000               |
| MU24-8RK        | 00961         | 26-24            | 8         | 0.25 | 0.28 | 0.53 | 0.40 | 0.020     | 0.13          | 0.030       | 1000               |

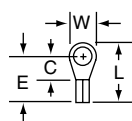

MU24-2R

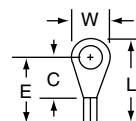

MU24-4R

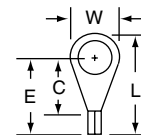

MU24-8R

|            |       |       |       |
|------------|-------|-------|-------|
| Stud Size  | 2     | 4     | 8     |
| Wire Range | 26-24 | 26-24 | 26-24 |

\*Product number ending in X = box; product number ending with K = bulk.

## 3M™ Ring Tongues — Non-Insulated Butted Seam 22-18 AWG



| Product Number* | UPC (054007-) | Wire Range (AWG) | Stud Size | W    | C    | L    | E    | Thickness | Barrel Length | Barrel I.D. | Terminals per Case |
|-----------------|---------------|------------------|-----------|------|------|------|------|-----------|---------------|-------------|--------------------|
| MU18-4R/SK      | 00998         | 22-18            | 4         | 0.25 | 0.22 | 0.60 | 0.47 | 0.030     | 0.25          | 0.070       | 1000               |
| MU18-6R/SK      | 01000         | 22-18            | 6         | 0.25 | 0.22 | 0.60 | 0.47 | 0.030     | 0.25          | 0.070       | 1000               |
| MU18-8R/LK      | 01005         | 22-18            | 8         | 0.31 | 0.33 | 0.74 | 0.58 | 0.030     | 0.25          | 0.070       | 1000               |
| MU18-10R/LK     | 01007         | 22-18            | 10        | 0.31 | 0.33 | 0.74 | 0.58 | 0.030     | 0.25          | 0.070       | 1000               |
| MU18-14R/SK     | 01008         | 22-18            | 1/4       | 0.47 | 0.40 | 0.89 | 0.65 | 0.030     | 0.25          | 0.070       | 1000               |
| MU18-38RK       | 01012         | 22-18            | 3/8       | 0.56 | 0.40 | 0.93 | 0.65 | 0.030     | 0.25          | 0.070       | 1000               |

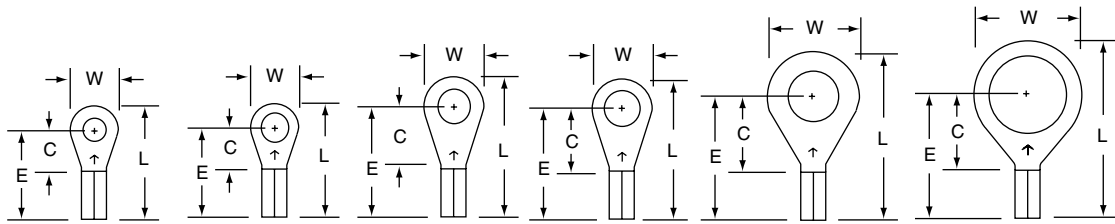

|            |       |       |       |       |       |       |
|------------|-------|-------|-------|-------|-------|-------|
| Stud Size  | 4     | 6     | 8     | 10    | 1/4   | 3/8   |
| Wire Range | 22-18 | 22-18 | 22-18 | 22-18 | 22-18 | 22-18 |

## 3M™ Ring Tongues — Non-Insulated Butted Seam 16-14 AWG



| Product Number* | UPC (054007-) | Wire Range (AWG) | Stud Size | W    | C    | L    | E    | Thickness | Barrel Length | Barrel I.D. | Terminals per Case |
|-----------------|---------------|------------------|-----------|------|------|------|------|-----------|---------------|-------------|--------------------|
| MU14-4R/SK      | 01364         | 16-14            | 4         | 0.25 | 0.22 | 0.60 | 0.47 | 0.030     | 0.25          | 0.090       | 1000               |
| MU14-6R/SK      | 01366         | 16-14            | 6         | 0.25 | 0.22 | 0.60 | 0.47 | 0.030     | 0.25          | 0.090       | 1000               |
| MU14-8R/LK      | 01371         | 16-14            | 8         | 0.31 | 0.33 | 0.74 | 0.58 | 0.030     | 0.25          | 0.090       | 1000               |
| MU14-10RK       | 01372         | 16-14            | 10        | 0.33 | 0.29 | 0.70 | 0.54 | 0.030     | 0.25          | 0.090       | 1000               |
| MU14-10R/LK     | 01373         | 16-14            | 10        | 0.31 | 0.33 | 0.74 | 0.58 | 0.030     | 0.25          | 0.090       | 1000               |
| MU14-14R/SK     | 01374         | 16-14            | 1/4       | 0.47 | 0.40 | 0.89 | 0.65 | 0.030     | 0.25          | 0.090       | 1000               |

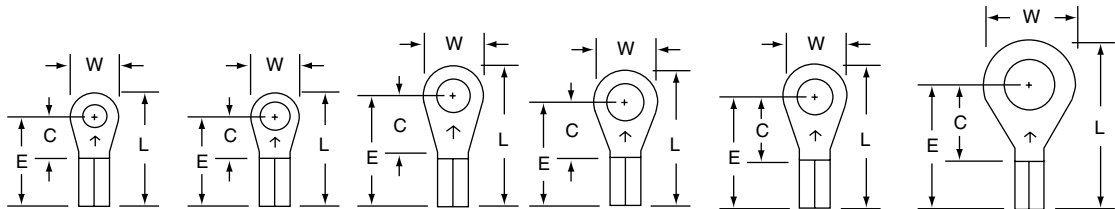

|            |       |       |       |       |       |       |
|------------|-------|-------|-------|-------|-------|-------|
| Stud Size  | 4     | 6     | 8     | 10    | 10    | 1/4   |
| Wire Range | 16-14 | 16-14 | 16-14 | 16-14 | 16-14 | 16-14 |

\*Product number ending in X = box; product number ending with K = bulk.

## 3M™ Ring Tongues — Non-Insulated Butted Seam 12-10 AWG



| Product Number | UPC (054007-) | Wire Range (AWG) | Stud Size | W    | C    | L    | E    | Thickness | Barrel Length | Barrel I.D. | Terminals per Case |
|----------------|---------------|------------------|-----------|------|------|------|------|-----------|---------------|-------------|--------------------|
| MU10-4R/SK     | 01876         | 12-10            | 4         | 0.28 | 0.29 | 0.68 | 0.54 | 0.040     | 0.25          | 0.135       | 500                |
| MU10-6RK       | 01878         | 12-10            | 6         | 0.38 | 0.29 | 0.73 | 0.54 | 0.040     | 0.25          | 0.135       | 500                |
| MU10-8RK       | 01880         | 12-10            | 8         | 0.38 | 0.29 | 0.73 | 0.54 | 0.040     | 0.25          | 0.135       | 500                |
| MU10-10RK      | 01881         | 12-10            | 10        | 0.38 | 0.29 | 0.73 | 0.54 | 0.040     | 0.25          | 0.135       | 500                |
| MU10-14R/SK    | 01882         | 12-10            | 1/4       | 0.53 | 0.44 | 0.96 | 0.69 | 0.040     | 0.25          | 0.135       | 500                |

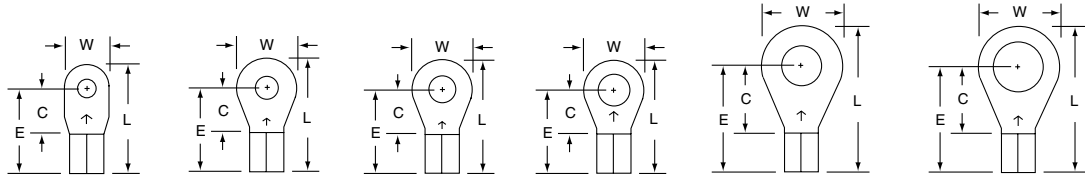

|            | MU10-4R/S | MU10-6R | MU10-8R | MU10-10R | MU10-14R/S | MU10-516R/S |
|------------|-----------|---------|---------|----------|------------|-------------|
| Stud Size  | 4         | 6       | 8       | 10       | 1/4        | 5/16        |
| Wire Range | 12-10     | 12-10   | 12-10   | 12-10    | 12-10      | 12-10       |

## 3M™ Ring Tongues — Vinyl Insulated Brazed Seam 22-18 AWG



| Product Number | UPC (054007-) | Wire Range (AWG) | Stud Size | W    | C    | L    | E    | Thickness | Barrel Length | Barrel I.D. | Maximum Insulation Diameter | Terminals per Carton | Case |
|----------------|---------------|------------------|-----------|------|------|------|------|-----------|---------------|-------------|-----------------------------|----------------------|------|
| MV18-4R/SX     | 21700         | 22-18            | 4         | 0.25 | 0.22 | 0.80 | 0.67 | 0.030     | 0.25          | 0.070       | 0.145                       | 100                  | 500  |
| MV18-4R/SK     | 01046         | 22-18            | 4         | 0.25 | 0.22 | 0.80 | 0.67 | 0.030     | 0.25          | 0.070       | 0.145                       | —                    | 1000 |
| MV18-6R/SX     | 21718         | 22-18            | 6         | 0.25 | 0.22 | 0.80 | 0.67 | 0.030     | 0.25          | 0.070       | 0.145                       | 100                  | 500  |
| MV18-6R/SK     | 01048         | 22-18            | 6         | 0.25 | 0.22 | 0.80 | 0.67 | 0.030     | 0.25          | 0.070       | 0.145                       | —                    | 1000 |
| MV18-8R/LX     | 21726         | 22-18            | 8         | 0.31 | 0.33 | 0.93 | 0.78 | 0.030     | 0.25          | 0.070       | 0.145                       | 100                  | 500  |
| MV18-8R/LK     | 01053         | 22-18            | 8         | 0.31 | 0.33 | 0.93 | 0.78 | 0.030     | 0.25          | 0.070       | 0.145                       | —                    | 1000 |
| MV18-10R/LX    | 21734         | 22-18            | 10        | 0.31 | 0.33 | 0.93 | 0.78 | 0.030     | 0.25          | 0.070       | 0.145                       | 100                  | 500  |
| MV18-10R/LK    | 01055         | 22-18            | 10        | 0.31 | 0.33 | 0.93 | 0.78 | 0.030     | 0.25          | 0.070       | 0.145                       | —                    | 1000 |
| MV18-14R/SX    | 21742         | 22-18            | 1/4       | 0.47 | 0.40 | 1.08 | 0.85 | 0.030     | 0.25          | 0.070       | 0.145                       | 100                  | 500  |
| MV18-14R/SK    | 01056         | 22-18            | 1/4       | 0.47 | 0.40 | 1.08 | 0.85 | 0.030     | 0.25          | 0.070       | 0.145                       | —                    | 1000 |
| MV18-516R/SX   | 49594         | 22-18            | 5/16      | 0.47 | 0.40 | 1.08 | 0.85 | 0.030     | 0.25          | 0.070       | 0.145                       | 100                  | 500  |
| MV18-38RX      | 21767         | 22-18            | 3/8       | 0.56 | 0.40 | 1.13 | 0.85 | 0.030     | 0.25          | 0.070       | 0.145                       | 100                  | 500  |
| MV18-38RK      | 01060         | 22-18            | 3/8       | 0.56 | 0.40 | 1.13 | 0.85 | 0.030     | 0.25          | 0.070       | 0.145                       | —                    | 1000 |

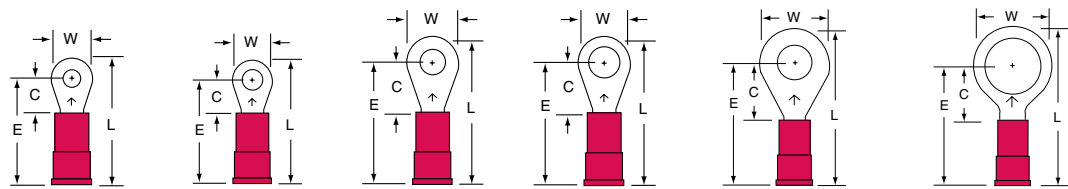

|            | MV18-4R/S | MV18-6R/S | MV18-8R/L | MV18-10R/L | MV18-14R/S | MV18-38R |
|------------|-----------|-----------|-----------|------------|------------|----------|
| Stud Size  | 4         | 6         | 8         | 10         | 1/4        | 3/8      |
| Wire Range | 22-18     | 22-18     | 22-18     | 22-18      | 22-18      | 22-18    |

\*Product number ending in X = box; product number ending with K = bulk.

# 3M™ Ring Tongues — Vinyl Insulated Brazed Seam 16-14 AWG



| Product Number <sup>1</sup> | UPC (054007-) | Wire Range (AWG) | Stud Size | W    | C    | L    | E    | Thickness | Barrel Length | Barrel I.D. | Maximum Insulation Diameter | Terminals per Carton | Case |
|-----------------------------|---------------|------------------|-----------|------|------|------|------|-----------|---------------|-------------|-----------------------------|----------------------|------|
| MV14-4R/SX                  | 22369         | 16-14            | 4         | 0.25 | 0.22 | 0.80 | 0.67 | 0.030     | 0.25          | 0.090       | 0.170                       | 100                  | 500  |
| MV14-4R/SK                  | 01412         | 16-14            | 4         | 0.25 | 0.22 | 0.80 | 0.67 | 0.030     | 0.25          | 0.090       | 0.170                       | —                    | 1000 |
| MV14-6R/SX                  | 22377         | 16-14            | 6         | 0.25 | 0.22 | 0.80 | 0.67 | 0.030     | 0.25          | 0.090       | 0.170                       | 100                  | 500  |
| MV14-6R/SK                  | 01414         | 16-14            | 6         | 0.25 | 0.22 | 0.80 | 0.67 | 0.030     | 0.25          | 0.090       | 0.170                       | —                    | 1000 |
| MV14-8R/SK                  | 01417         | 16-14            | 8         | 0.25 | 0.22 | 0.80 | 0.67 | 0.030     | 0.25          | 0.090       | 0.170                       | —                    | 1000 |
| MV14-8R/LX                  | 22385         | 16-14            | 8         | 0.31 | 0.33 | 0.93 | 0.78 | 0.030     | 0.25          | 0.090       | 0.170                       | 100                  | 500  |
| MV14-8R/LK                  | 01419         | 16-14            | 8         | 0.31 | 0.33 | 0.93 | 0.78 | 0.030     | 0.25          | 0.090       | 0.170                       | —                    | 1000 |
| MV14-10RK                   | 01420         | 16-14            | 10        | 0.33 | 0.29 | 0.90 | 0.74 | 0.030     | 0.25          | 0.090       | 0.170                       | —                    | 1000 |
| MV14-10R/LX                 | 22393         | 16-14            | 10        | 0.31 | 0.33 | 0.93 | 0.78 | 0.030     | 0.25          | 0.090       | 0.170                       | 100                  | 500  |
| MV14-10R/LK                 | 01421         | 16-14            | 10        | 0.31 | 0.33 | 0.93 | 0.78 | 0.030     | 0.25          | 0.090       | 0.170                       | —                    | 1000 |
| MV14-14R/SX                 | 22401         | 16-14            | 1/4       | 0.47 | 0.40 | 1.08 | 0.85 | 0.030     | 0.25          | 0.090       | 0.170                       | 100                  | 500  |
| MV14-14R/SK                 | 01422         | 16-14            | 1/4       | 0.47 | 0.40 | 1.08 | 0.85 | 0.030     | 0.25          | 0.090       | 0.170                       | —                    | 1000 |
| MV14-516R/SX                | 49615         | 16-14            | 5/16      | 0.47 | 0.40 | 1.08 | 0.85 | 0.030     | 0.25          | 0.090       | 0.170                       | 100                  | 500  |
| MV14-516R/SK                | 01424         | 16-14            | 5/16      | 0.47 | 0.40 | 1.08 | 0.85 | 0.030     | 0.25          | 0.090       | 0.170                       | —                    | 1000 |
| MV14-38RX                   | 22427         | 16-14            | 3/8       | 0.56 | 0.40 | 1.13 | 0.85 | 0.030     | 0.25          | 0.090       | 0.170                       | 100                  | 500  |
| MV14-38RK                   | 00546         | 16-14            | 3/8       | 0.56 | 0.40 | 1.13 | 0.85 | 0.030     | 0.25          | 0.090       | 0.170                       | —                    | 1000 |

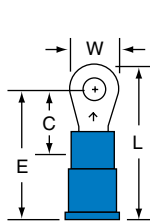

MV14-4R/S

Stud Size

4

Wire Range

16-14

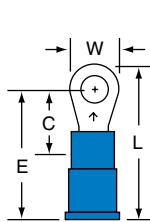

MV14-6R/S

6

16-14

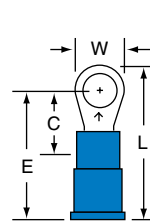

MV14-8R/S

8

16-14

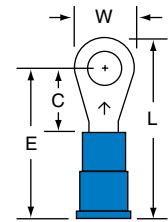

MV14-8R/L

8

16-14

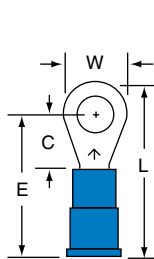

MV14-10R

Stud Size

10

Wire Range

16-14

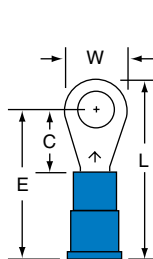

MV14-10R/L

10

16-14

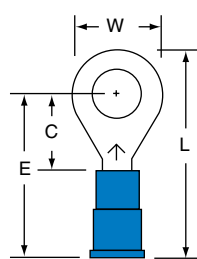

MV14-14R/S

1/4

16-14

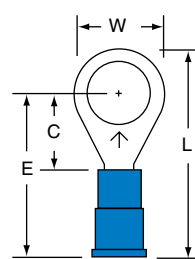

MV14-516R/S

5/16

16-14

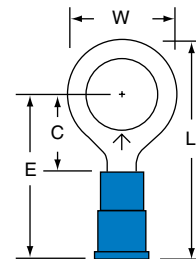

MV14-38R

3/8

16-14

<sup>1</sup>Product number ending in X = box; product number ending with K = bulk.

# 3M™ Ring Tongues — Vinyl Insulated Brazen Seam 12-10 AWG



| Product Number* | UPC (054007-) | Wire Range (AWG) | Stud Size | W    | C    | L    | E    | Thickness | Barrel Length | Barrel I.D. | Maximum Insulation Diameter | Terminals per Carton | Case |
|-----------------|---------------|------------------|-----------|------|------|------|------|-----------|---------------|-------------|-----------------------------|----------------------|------|
| MV10-4R/SK      | 01918         | 12-10            | 4         | 0.28 | 0.29 | 0.98 | 0.84 | 0.040     | 0.25          | 0.135       | 0.250                       | —                    | 500  |
| MV10-6RX        | 23334         | 12-10            | 6         | 0.38 | 0.29 | 1.03 | 0.84 | 0.040     | 0.25          | 0.135       | 0.250                       | 50                   | 500  |
| MV10-6RK        | 01920         | 12-10            | 6         | 0.38 | 0.29 | 1.03 | 0.84 | 0.040     | 0.25          | 0.135       | 0.250                       | —                    | 500  |
| MV10-8RX        | 23342         | 12-10            | 8         | 0.38 | 0.29 | 1.03 | 0.84 | 0.040     | 0.25          | 0.135       | 0.250                       | 50                   | 500  |
| MV10-8RK        | 01922         | 12-10            | 8         | 0.38 | 0.29 | 1.03 | 0.84 | 0.040     | 0.25          | 0.135       | 0.250                       | —                    | 500  |
| MV10-10RX       | 23359         | 12-10            | 10        | 0.38 | 0.29 | 1.03 | 0.84 | 0.040     | 0.25          | 0.135       | 0.250                       | 50                   | 500  |
| MV10-10RK       | 01923         | 12-10            | 10        | 0.38 | 0.29 | 1.03 | 0.84 | 0.040     | 0.25          | 0.135       | 0.250                       | —                    | 500  |
| MV10-14R/SX     | 23367         | 12-10            | 1/4       | 0.53 | 0.44 | 1.26 | 0.99 | 0.040     | 0.25          | 0.135       | 0.250                       | 50                   | 500  |
| MV10-14R/SK     | 01924         | 12-10            | 1/4       | 0.53 | 0.44 | 1.26 | 0.99 | 0.040     | 0.25          | 0.135       | 0.250                       | —                    | 500  |
| MV10-516R/SX    | 23375         | 12-10            | 5/16      | 0.53 | 0.44 | 1.26 | 0.99 | 0.040     | 0.25          | 0.135       | 0.250                       | 50                   | 500  |
| MV10-516R/SK    | 01926         | 12-10            | 5/16      | 0.53 | 0.44 | 1.26 | 0.99 | 0.040     | 0.25          | 0.135       | 0.250                       | —                    | 500  |
| MV10-38R/SX     | 49639         | 12-10            | 3/8       | 0.54 | 0.44 | 1.26 | 0.99 | 0.040     | 0.25          | 0.135       | 0.250                       | 50                   | 500  |
| MV10-38R/SK     | 01928         | 12-10            | 3/8       | 0.54 | 0.44 | 1.26 | 0.99 | 0.040     | 0.25          | 0.135       | 0.250                       | —                    | 500  |
| MV10-12RX       | 23409         | 12-10            | 1/2       | 0.75 | 0.57 | 1.50 | 1.12 | 0.040     | 0.25          | 0.135       | 0.250                       | 50                   | 500  |
| MV10-12RK       | 01931         | 12-10            | 1/2       | 0.75 | 0.57 | 1.50 | 1.12 | 0.040     | 0.25          | 0.135       | 0.250                       | —                    | 500  |

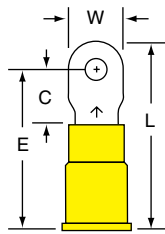

MV10-4R/S

Stud Size

4

Wire Range

12-10

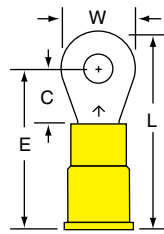

MV10-6R

6

12-10

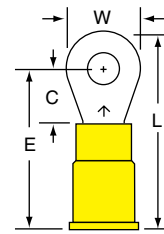

MV10-8R

8

12-10

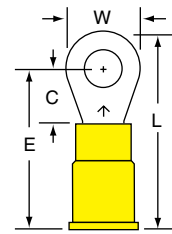

MV10-10R

10

12-10

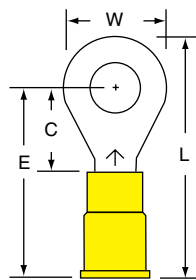

MV10-14R/S

Stud Size

1/4

Wire Range

12-10

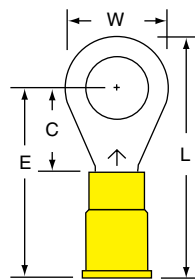

MV10-516R/S

5/16

12-10

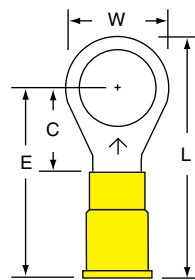

MV10-38R/S

3/8

12-10

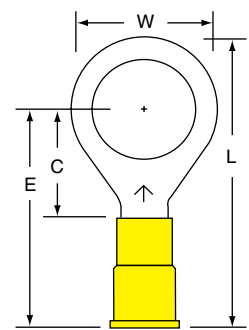

MV10-12R

1/2

12-10

\*Product number ending in X = box; product number ending with K = bulk.

# 3M™ Ring Tongues — Vinyl Insulated Butted Seam 22-18 AWG



| Product Number* | UPC (054007-) | Wire Range (AWG) | Stud Size | W    | C    | L    | E    | Thickness | Barrel Length | Barrel I.D. | Maximum Insulation Diameter | Terminals per Case |
|-----------------|---------------|------------------|-----------|------|------|------|------|-----------|---------------|-------------|-----------------------------|--------------------|
| MVU18-4R/SK     | 01078         | 22-18            | 4         | 0.25 | 0.22 | 0.80 | 0.67 | 0.030     | 0.25          | 0.070       | 0.145                       | 1000               |
| MVU18-6R/SK     | 01080         | 22-18            | 6         | 0.25 | 0.22 | 0.80 | 0.67 | 0.030     | 0.25          | 0.070       | 0.145                       | 1000               |
| MVU18-8R/LK     | 01085         | 22-18            | 8         | 0.31 | 0.33 | 0.93 | 0.78 | 0.030     | 0.25          | 0.070       | 0.145                       | 1000               |
| MVU18-10R/LK    | 01087         | 22-18            | 10        | 0.31 | 0.33 | 0.93 | 0.78 | 0.030     | 0.25          | 0.070       | 0.145                       | 1000               |
| MVU18-14R/SK    | 01088         | 22-18            | 1/4       | 0.47 | 0.40 | 1.08 | 0.85 | 0.030     | 0.25          | 0.070       | 0.145                       | 1000               |
| MVU18-516R/SK   | 01090         | 22-18            | 5/16      | 0.47 | 0.40 | 1.08 | 0.85 | 0.030     | 0.25          | 0.070       | 0.145                       | 1000               |
| MVU18-38RK      | 01092         | 22-18            | 3/8       | 0.56 | 0.40 | 1.13 | 0.85 | 0.030     | 0.25          | 0.070       | 0.145                       | 1000               |

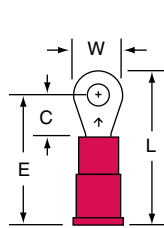

MVU18-4R/S

Stud Size  
4

Wire Range  
22-18

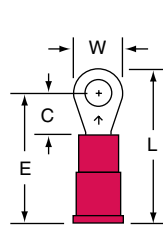

MVU18-6R/S

Stud Size  
6

Wire Range  
22-18

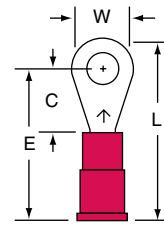

MVU18-8R/L

Stud Size  
8

Wire Range  
22-18

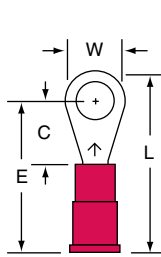

MVU18-10R/L

Stud Size  
10

Wire Range  
22-18

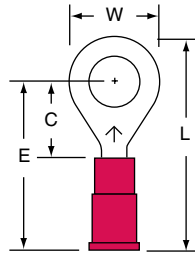

MVU18-14R/S

Stud Size  
1/4

Wire Range  
22-18

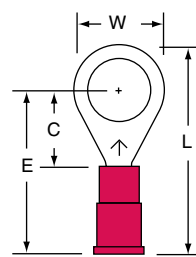

MVU18-516R/S

Stud Size  
5/16

Wire Range  
22-18

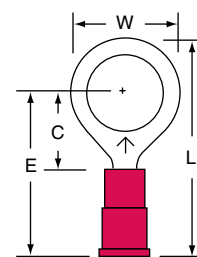

MVU18-38R

Stud Size  
3/8

Wire Range  
22-18

\*Product number ending in X = box; product number ending with K = bulk.

# 3M™ Ring Tongues — Vinyl Insulated Butted Seam 16-14 AWG



| Product Number* | UPC (054007-) | Wire Range (AWG) | Stud Size | W    | C    | L    | E    | Thickness | Barrel Length | Barrel I.D. | Maximum Insulation Diameter | Terminals per Case |
|-----------------|---------------|------------------|-----------|------|------|------|------|-----------|---------------|-------------|-----------------------------|--------------------|
| MVU14-4R/SK     | 01444         | 16-14            | 4         | 0.25 | 0.22 | 0.80 | 0.67 | 0.030     | 0.25          | 0.090       | 0.170                       | 1000               |
| MVU14-6R/SK     | 01446         | 16-14            | 6         | 0.25 | 0.22 | 0.80 | 0.67 | 0.030     | 0.25          | 0.090       | 0.170                       | 1000               |
| MVU14-8R/SK     | 01449         | 16-14            | 8         | 0.25 | 0.22 | 0.80 | 0.67 | 0.030     | 0.25          | 0.090       | 0.170                       | 1000               |
| MVU14-8RK       | 01450         | 16-14            | 8         | 0.33 | 0.29 | 0.90 | 0.74 | 0.030     | 0.25          | 0.090       | 0.170                       | 1000               |
| MVU14-8R/LK     | 01451         | 16-14            | 8         | 0.31 | 0.33 | 0.93 | 0.78 | 0.030     | 0.25          | 0.090       | 0.170                       | 1000               |
| MVU14-10RK      | 01452         | 16-14            | 10        | 0.33 | 0.29 | 0.90 | 0.74 | 0.030     | 0.25          | 0.090       | 0.170                       | 1000               |
| MVU14-10R/LK    | 01453         | 16-14            | 10        | 0.31 | 0.33 | 0.93 | 0.78 | 0.030     | 0.25          | 0.090       | 0.170                       | 1000               |
| MVU14-14R/SK    | 01454         | 16-14            | 1/4       | 0.47 | 0.40 | 1.08 | 0.85 | 0.030     | 0.25          | 0.090       | 0.170                       | 1000               |
| MVU14-516R/SK   | 01456         | 16-14            | 5/16      | 0.47 | 0.40 | 1.08 | 0.85 | 0.030     | 0.25          | 0.090       | 0.170                       | 1000               |
| MVU14-38RK      | 01458         | 16-14            | 3/8       | 0.56 | 0.40 | 1.13 | 0.85 | 0.030     | 0.25          | 0.090       | 0.170                       | 1000               |

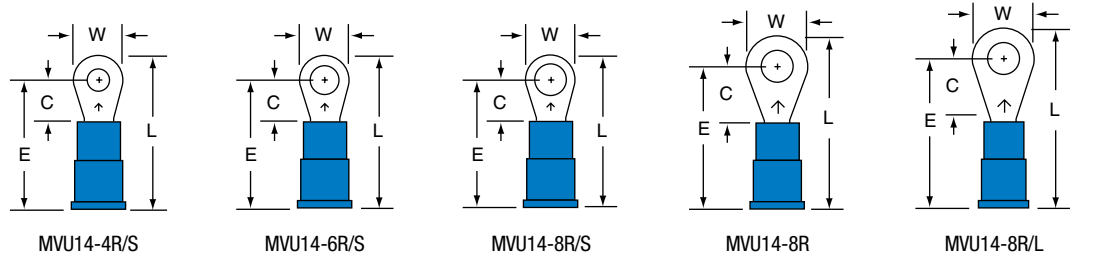

|            |       |       |       |       |       |
|------------|-------|-------|-------|-------|-------|
| Stud Size  | 4     | 6     | 8     | 8     | 8     |
| Wire Range | 16-14 | 16-14 | 16-14 | 16-14 | 16-14 |

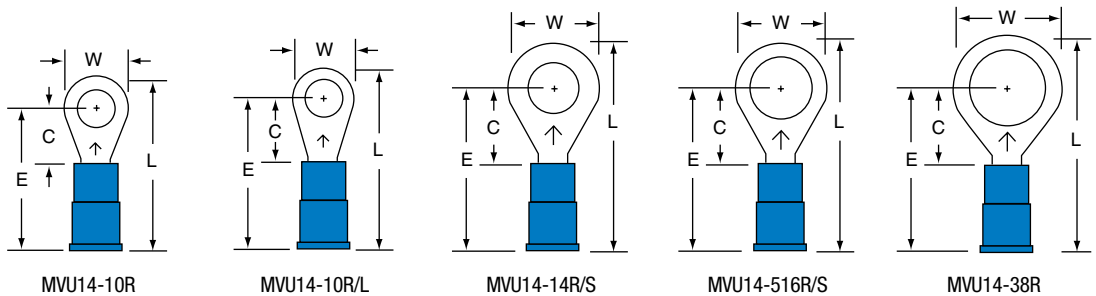

|            |       |       |       |       |       |
|------------|-------|-------|-------|-------|-------|
| Stud Size  | 10    | 10    | 1/4   | 5/16  | 3/8   |
| Wire Range | 16-14 | 16-14 | 16-14 | 16-14 | 16-14 |

\*Product number ending in X = box; product number ending with K = bulk.

# 3M™ Ring Tongues — Vinyl Insulated Butted Seam 12-10 AWG



| Product Number* | UPC (054007-) | Wire Range (AWG) | Stud Size | W    | C    | L    | E    | Thickness | Barrel Length | Barrel I.D. | Maximum Insulation Diameter | Terminals per Case |
|-----------------|---------------|------------------|-----------|------|------|------|------|-----------|---------------|-------------|-----------------------------|--------------------|
| MVU10-4R/SK     | 01946         | 12-10            | 4         | 0.28 | 0.29 | 0.98 | 0.84 | 0.040     | 0.25          | 0.135       | 0.250                       | 500                |
| MVU10-6RK       | 01948         | 12-10            | 6         | 0.38 | 0.29 | 1.03 | 0.84 | 0.040     | 0.25          | 0.135       | 0.250                       | 500                |
| MVU10-8RK       | 01950         | 12-10            | 8         | 0.38 | 0.29 | 1.03 | 0.84 | 0.040     | 0.25          | 0.135       | 0.250                       | 500                |
| MVU10-10RK      | 01951         | 12-10            | 10        | 0.38 | 0.29 | 1.03 | 0.84 | 0.040     | 0.25          | 0.135       | 0.250                       | 500                |
| MVU10-14R/SK    | 01952         | 12-10            | 1/4       | 0.53 | 0.44 | 1.26 | 0.99 | 0.040     | 0.25          | 0.135       | 0.250                       | 500                |
| MVU10-516R/SK   | 01954         | 12-10            | 5/16      | 0.53 | 0.44 | 1.26 | 0.99 | 0.040     | 0.25          | 0.135       | 0.250                       | 500                |
| MVU10-38R/SK    | 01956         | 12-10            | 3/8       | 0.54 | 0.44 | 1.26 | 0.99 | 0.040     | 0.25          | 0.135       | 0.250                       | 500                |

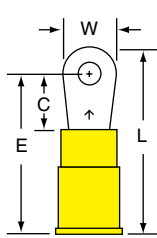

MVU10-4R/S

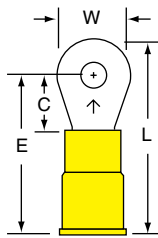

MVU10-6R

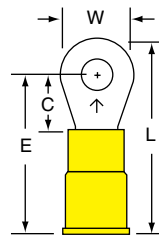

MVU10-8R

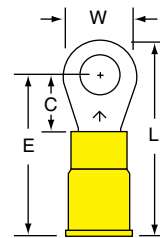

MVU10-10R

Stud Size

4

6

8

10

Wire Range

12-10

12-10

12-10

12-10

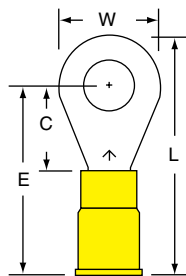

MVU10-14R/S

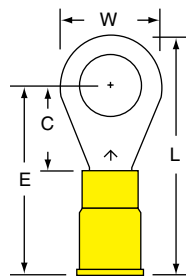

MVU10-516R/S

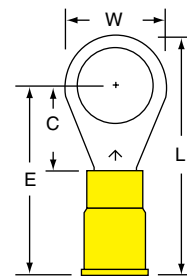

MVU10-38R/S

Stud Size

1/4

5/16

3/8

Wire Range

12-10

12-10

12-10

\*Product number ending in X = box; product number ending with K = bulk.



### 3M™ Ring Tongues — Nylon Insulated Brazed Seam 8 AWG



| Product Number* | UPC (054007-) | Wire Range (AWG) | Stud Size | W    | C    | L    | E    | Thickness | Barrel Length | Barrel I.D. | Maximum Insulation Diameter | Terminals per: Carton | Case |
|-----------------|---------------|------------------|-----------|------|------|------|------|-----------|---------------|-------------|-----------------------------|-----------------------|------|
| MN8-10R/SK      | 08267         | 8                | 10        | 0.47 | 0.40 | 1.26 | 1.03 | 0.050     | 0.31          | 0.175       | 0.340                       | —                     | 200  |
| MN8-14R/SX      | 15652         | 8                | 1/4       | 0.47 | 0.40 | 1.26 | 1.03 | 0.050     | 0.31          | 0.175       | 0.340                       | 25                    | 250  |
| MN8-14R/SK      | 08268         | 8                | 1/4       | 0.47 | 0.40 | 1.26 | 1.03 | 0.050     | 0.31          | 0.175       | 0.340                       | —                     | 200  |
| MN8-516RK       | 08269         | 8                | 5/16      | 0.59 | 0.45 | 1.38 | 1.08 | 0.050     | 0.31          | 0.175       | 0.340                       | —                     | 200  |
| MN8-38RK        | 08270         | 8                | 3/8       | 0.59 | 0.45 | 1.38 | 1.08 | 0.050     | 0.31          | 0.175       | 0.340                       | —                     | 200  |
| MN8-12R/SK      | 08271         | 8                | 1/2       | 0.81 | 0.69 | 1.72 | 1.32 | 0.050     | 0.31          | 0.175       | 0.340                       | —                     | 200  |

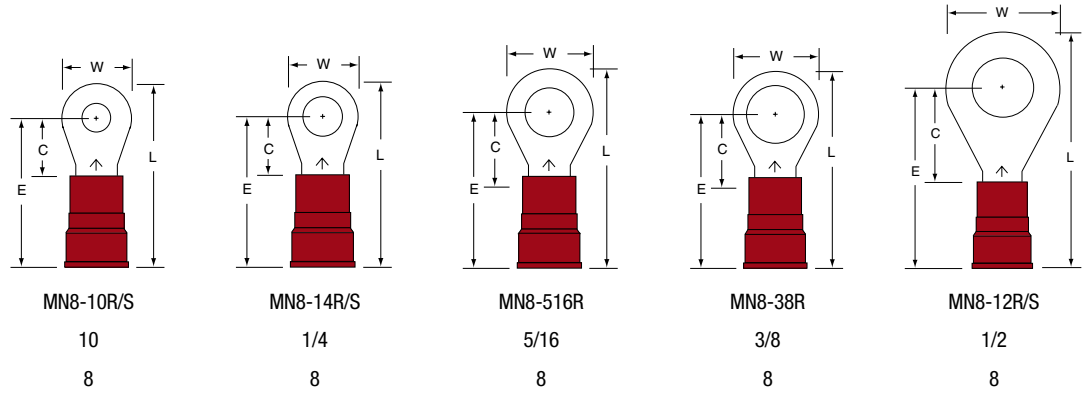

### 3M™ Ring Tongues — Nylon Insulated Brazed Seam 6 AWG



| Product Number* | UPC (054007-) | Wire Range (AWG) | Stud Size | W    | C    | L    | E    | Thickness | Barrel Length | Barrel I.D. | Maximum Insulation Diameter | Terminals per: Carton | Case |
|-----------------|---------------|------------------|-----------|------|------|------|------|-----------|---------------|-------------|-----------------------------|-----------------------|------|
| MN6-10R/SK      | 08272         | 6                | 10        | 0.47 | 0.52 | 1.50 | 1.27 | 0.050     | 0.39          | 0.250       | 0.440                       | —                     | 200  |
| MN6-14R/SX      | 15660         | 6                | 1/4       | 0.47 | 0.52 | 1.50 | 1.27 | 0.050     | 0.39          | 0.250       | 0.440                       | 20                    | 200  |
| MN6-14R/SK      | 08273         | 6                | 1/4       | 0.47 | 0.52 | 1.50 | 1.27 | 0.050     | 0.39          | 0.250       | 0.440                       | —                     | 200  |
| MN6-516RK       | 08274         | 6                | 5/16      | 0.63 | 0.52 | 1.58 | 1.27 | 0.050     | 0.39          | 0.250       | 0.440                       | —                     | 200  |
| MN6-38RK        | 08275         | 6                | 3/8       | 0.63 | 0.52 | 1.58 | 1.27 | 0.050     | 0.39          | 0.250       | 0.440                       | —                     | 200  |
| MN6-12R/SK      | 08276         | 6                | 1/2       | 0.81 | 0.63 | 1.78 | 1.38 | 0.050     | 0.39          | 0.250       | 0.440                       | —                     | 200  |

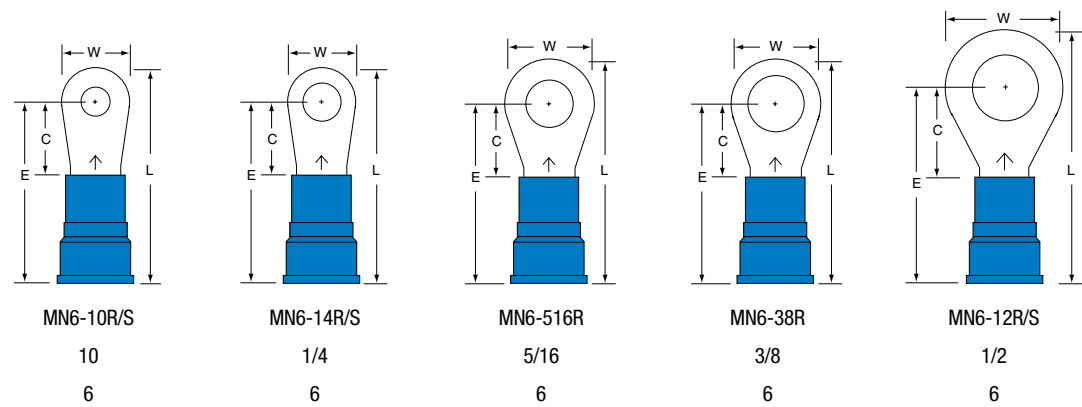

\*Product number ending in X = box; product number ending with K = bulk.

## 3M™ Ring Tongues — Nylon Insulated Brazed Seam 4 AWG



| Product Number <sup>a</sup> | UPC (054007-) | Wire Range (AWG) | Stud Size | W    | C    | L    | E    | Thickness | Barrel Length | Barrel I.D. | Maximum Insulation Diameter | Terminals per: Carton | Case |
|-----------------------------|---------------|------------------|-----------|------|------|------|------|-----------|---------------|-------------|-----------------------------|-----------------------|------|
| MN4-10RK                    | 08277         | 4                | 10        | 0.68 | 0.53 | 1.74 | 1.41 | 0.075     | 0.47          | 0.280       | 0.515                       | —                     | 200  |
| MN4-14RK                    | 08278         | 4                | 1/4       | 0.68 | 0.53 | 1.74 | 1.41 | 0.075     | 0.47          | 0.280       | 0.515                       | —                     | 200  |
| MN4-516RK                   | 08279         | 4                | 5/16      | 0.68 | 0.53 | 1.74 | 1.41 | 0.075     | 0.47          | 0.280       | 0.515                       | —                     | 200  |
| MN4-38RK                    | 08280         | 4                | 3/8       | 0.68 | 0.53 | 1.74 | 1.41 | 0.075     | 0.47          | 0.280       | 0.515                       | —                     | 200  |
| MN4-12R/SK                  | 08281         | 4                | 1/2       | 0.68 | 0.53 | 1.74 | 1.41 | 0.075     | 0.47          | 0.280       | 0.515                       | —                     | 200  |

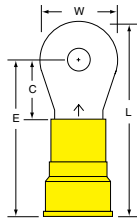

MN4-10R

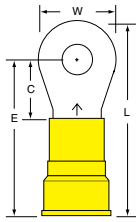

MN4-14R

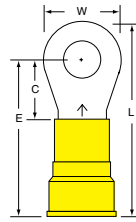

MN4-516R

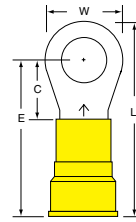

MN4-38R

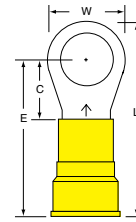

MN4-12R/S

Stud Size

10

1/4

5/16

3/8

1/2

Wire Range

4

4

4

4

4

## 3M™ Ring Tongues — Nylon Insulated 26-24 AWG



| Product Number <sup>a</sup> | UPC (054007-) | Wire Range (AWG) | Stud Size | W    | C    | L    | E    | Thickness | Barrel Length | Barrel I.D. | Maximum Insulation Diameter | Terminals per: Carton | Case |
|-----------------------------|---------------|------------------|-----------|------|------|------|------|-----------|---------------|-------------|-----------------------------|-----------------------|------|
| MN24-2RK                    | 95136         | 26-24            | 2         | 0.14 | 0.12 | 0.47 | 0.40 | 0.020     | 0.13          | 0.030       | 0.093                       | —                     | 1000 |
| MN24-4RX                    | 11318         | 26-24            | 4         | 0.20 | 0.21 | 0.60 | 0.49 | 0.020     | 0.14          | 0.030       | 0.093                       | 100                   | 500  |
| MN24-4RK                    | 00971         | 26-24            | 4         | 0.20 | 0.21 | 0.60 | 0.49 | 0.020     | 0.14          | 0.030       | 0.093                       | —                     | 1000 |
| MN24-6RX                    | 49587         | 26-24            | 6         | 0.20 | 0.21 | 0.60 | 0.49 | 0.020     | 0.14          | 0.030       | 0.093                       | 100                   | 500  |
| MN24-6RK                    | 00972         | 26-24            | 6         | 0.20 | 0.21 | 0.60 | 0.49 | 0.020     | 0.14          | 0.030       | 0.093                       | —                     | 1000 |
| MN24-8RX                    | 49588         | 26-24            | 8         | 0.25 | 0.28 | 0.69 | 0.56 | 0.020     | 0.13          | 0.030       | 0.093                       | 100                   | 500  |
| MN24-8RK                    | 00973         | 26-24            | 8         | 0.25 | 0.28 | 0.69 | 0.56 | 0.020     | 0.13          | 0.030       | 0.093                       | —                     | 1000 |
| MN24-10RX                   | 11321         | 26-24            | 10        | 0.25 | 0.28 | 0.69 | 0.56 | 0.020     | 0.13          | 0.030       | 0.093                       | 100                   | 500  |
| MN24-10RK                   | 00974         | 26-24            | 10        | 0.25 | 0.28 | 0.69 | 0.56 | 0.020     | 0.13          | 0.030       | 0.093                       | —                     | 1000 |

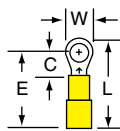

MN24-2R

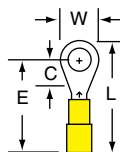

MN24-4R

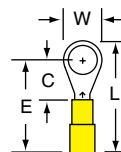

MN24-6R

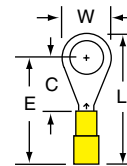

MN24-8R

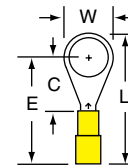

MN24-10R

Stud Size

2

4

6

8

10

Wire Range

26-24

26-24

26-24

26-24

26-24

<sup>a</sup>Product number ending in X = box; product number ending with K = bulk.

# 3M™ Ring Tongues — Nylon Insulated with Insulation Grip 22-18 AWG



| Product Number* | UPC (054007-) | Wire Range (AWG) | Stud Size | W    | C    | L    | E    | Thickness | Barrel Length | Barrel I.D. | Maximum Insulation Diameter | Terminals per Carton | Case |
|-----------------|---------------|------------------|-----------|------|------|------|------|-----------|---------------|-------------|-----------------------------|----------------------|------|
| MNG18-4R/SX     | 49595         | 22-18            | 4         | 0.25 | 0.22 | 0.79 | 0.66 | 0.030     | 0.25          | 0.070       | 0.145                       | 100                  | 500  |
| MNG18-4R/SK     | 01062         | 22-18            | 4         | 0.25 | 0.22 | 0.79 | 0.66 | 0.030     | 0.25          | 0.070       | 0.145                       | —                    | 1000 |
| MNG18-6R/SX     | 21791         | 22-18            | 6         | 0.25 | 0.22 | 0.79 | 0.66 | 0.030     | 0.25          | 0.070       | 0.145                       | 100                  | 500  |
| MNG18-6R/SK     | 16163         | 22-18            | 6         | 0.25 | 0.22 | 0.79 | 0.66 | 0.030     | 0.25          | 0.070       | 0.145                       | —                    | 1000 |
| MNG18-8R/LX     | 21809         | 22-18            | 8         | 0.31 | 0.33 | 0.92 | 0.77 | 0.030     | 0.25          | 0.070       | 0.145                       | 100                  | 500  |
| MNG18-8R/LK     | 01069         | 22-18            | 8         | 0.31 | 0.33 | 0.92 | 0.77 | 0.030     | 0.25          | 0.070       | 0.145                       | —                    | 1000 |
| MNG18-10R/LX    | 21817         | 22-18            | 10        | 0.31 | 0.33 | 0.92 | 0.77 | 0.030     | 0.25          | 0.070       | 0.145                       | 100                  | 500  |
| MNG18-10R/LK    | 01071         | 22-18            | 10        | 0.31 | 0.33 | 0.92 | 0.77 | 0.030     | 0.25          | 0.070       | 0.145                       | —                    | 1000 |
| MNG18-14R/SX    | 49596         | 22-18            | 1/4       | 0.47 | 0.40 | 1.07 | 0.84 | 0.030     | 0.25          | 0.070       | 0.145                       | 100                  | 500  |
| MNG18-14R/SK    | 01072         | 22-18            | 1/4       | 0.47 | 0.40 | 1.07 | 0.84 | 0.030     | 0.25          | 0.070       | 0.145                       | —                    | 1000 |
| MNG18-516R/SX   | 49597         | 22-18            | 5/16      | 0.47 | 0.40 | 1.07 | 0.84 | 0.030     | 0.25          | 0.070       | 0.145                       | 100                  | 500  |
| MNG18-516R/SK   | 01074         | 22-18            | 5/16      | 0.47 | 0.40 | 1.07 | 0.84 | 0.030     | 0.25          | 0.070       | 0.145                       | —                    | 1000 |
| MNG18-38RX      | 49598         | 22-18            | 3/8       | 0.56 | 0.40 | 1.12 | 0.84 | 0.030     | 0.25          | 0.070       | 0.145                       | 100                  | 500  |
| MNG18-38RK      | 01076         | 22-18            | 3/8       | 0.56 | 0.40 | 1.12 | 0.84 | 0.030     | 0.25          | 0.070       | 0.145                       | —                    | 1000 |

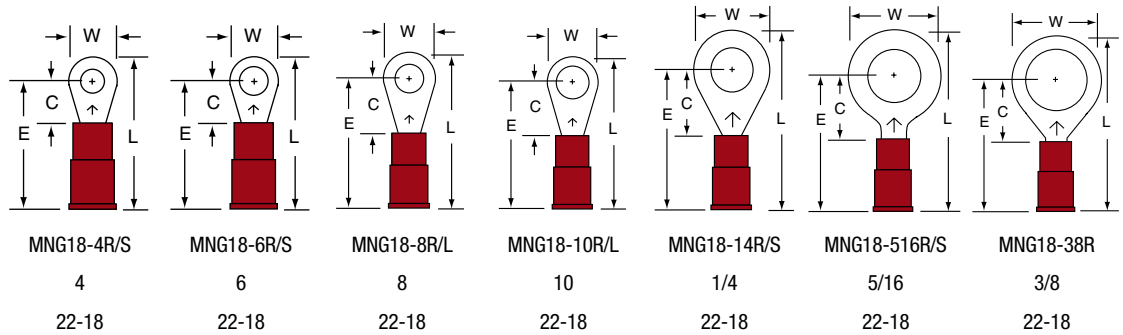

\*Product number ending in X = box; product number ending with K = bulk.

# 3M™ Ring Tongues — Nylon Insulated with Insulation Grip 16-14 AWG



| Product Number <sup>1</sup> | UPC (054007-) | Wire Range (AWG) | Stud Size | W    | C    | L    | E    | Thickness | Barrel Length | Barrel I.D. | Maximum Insulation Diameter | Terminals per Carton | Case |
|-----------------------------|---------------|------------------|-----------|------|------|------|------|-----------|---------------|-------------|-----------------------------|----------------------|------|
| MNG14-4R/SX                 | 49616         | 16-14            | 4         | 0.25 | 0.22 | 0.81 | 0.68 | 0.030     | 0.25          | 0.090       | 0.170                       | 100                  | 500  |
| MNG14-4R/SK                 | 01428         | 16-14            | 4         | 0.25 | 0.22 | 0.81 | 0.68 | 0.030     | 0.25          | 0.090       | 0.170                       | —                    | 1000 |
| MNG14-6R/SX                 | 22468         | 16-14            | 6         | 0.25 | 0.22 | 0.81 | 0.68 | 0.030     | 0.25          | 0.090       | 0.170                       | 100                  | 500  |
| MNG14-6R/SK                 | 01430         | 16-14            | 6         | 0.25 | 0.22 | 0.81 | 0.68 | 0.030     | 0.25          | 0.090       | 0.170                       | —                    | 1000 |
| MNG14-8R/SX                 | 49617         | 16-14            | 8         | 0.25 | 0.22 | 0.81 | 0.68 | 0.030     | 0.25          | 0.090       | 0.170                       | 100                  | 500  |
| MNG14-8R/SK                 | 01433         | 16-14            | 8         | 0.25 | 0.22 | 0.81 | 0.68 | 0.030     | 0.25          | 0.090       | 0.170                       | —                    | 1000 |
| MNG14-8RX                   | 49618         | 16-14            | 8         | 0.33 | 0.29 | 0.91 | 0.75 | 0.030     | 0.25          | 0.090       | 0.170                       | 100                  | 500  |
| MNG14-8RK                   | 01434         | 16-14            | 8         | 0.33 | 0.29 | 0.91 | 0.75 | 0.030     | 0.25          | 0.090       | 0.170                       | —                    | 1000 |
| MNG14-8R/LX                 | 22476         | 16-14            | 8         | 0.31 | 0.33 | 0.94 | 0.79 | 0.030     | 0.25          | 0.090       | 0.170                       | 100                  | 500  |
| MNG14-8R/LK                 | 01435         | 16-14            | 8         | 0.31 | 0.33 | 0.94 | 0.79 | 0.030     | 0.25          | 0.090       | 0.170                       | —                    | 1000 |
| MNG14-10RX                  | 49619         | 16-14            | 10        | 0.33 | 0.29 | 0.91 | 0.75 | 0.030     | 0.25          | 0.090       | 0.170                       | 100                  | 500  |
| MNG14-10RK                  | 14150         | 16-14            | 10        | 0.33 | 0.29 | 0.91 | 0.75 | 0.030     | 0.25          | 0.090       | 0.170                       | —                    | 1000 |
| MNG14-10R/LX                | 22484         | 16-14            | 10        | 0.31 | 0.33 | 0.94 | 0.79 | 0.030     | 0.25          | 0.090       | 0.170                       | 100                  | 500  |
| MNG14-10R/LK                | 01437         | 16-14            | 10        | 0.31 | 0.33 | 0.94 | 0.79 | 0.030     | 0.25          | 0.090       | 0.170                       | —                    | 1000 |
| MNG14-14R/SX                | 22492         | 16-14            | 1/4       | 0.47 | 0.40 | 1.09 | 0.86 | 0.030     | 0.25          | 0.090       | 0.170                       | 100                  | 500  |
| MNG14-14R/SK                | 01438         | 16-14            | 1/4       | 0.47 | 0.40 | 1.09 | 0.86 | 0.030     | 0.25          | 0.090       | 0.170                       | —                    | 1000 |
| MNG14-516R/SX               | 49620         | 16-14            | 5/16      | 0.47 | 0.40 | 1.09 | 0.86 | 0.030     | 0.25          | 0.090       | 0.170                       | 100                  | 500  |
| MNG14-516R/SK               | 01440         | 16-14            | 5/16      | 0.47 | 0.40 | 1.09 | 0.86 | 0.030     | 0.25          | 0.090       | 0.170                       | —                    | 1000 |
| MNG14-38RX                  | 49621         | 16-14            | 3/8       | 0.56 | 0.40 | 1.14 | 0.86 | 0.030     | 0.25          | 0.090       | 0.170                       | 100                  | 500  |
| MNG14-38RK                  | 01442         | 16-14            | 3/8       | 0.56 | 0.40 | 1.14 | 0.86 | 0.030     | 0.25          | 0.090       | 0.170                       | —                    | 1000 |

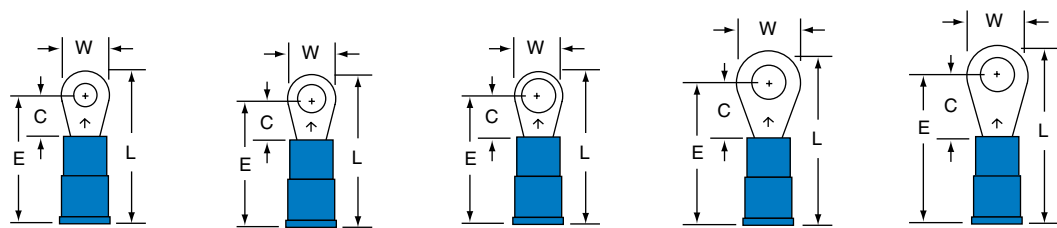

MNG14-4R/S Stud Size 4 Wire Range 16-14  
 MNG14-6R/S Stud Size 6 Wire Range 16-14  
 MNG14-8R/S Stud Size 8 Wire Range 16-14  
 MNG14-8R Stud Size 8 Wire Range 16-14  
 MNG14-8R/L Stud Size 8 Wire Range 16-14

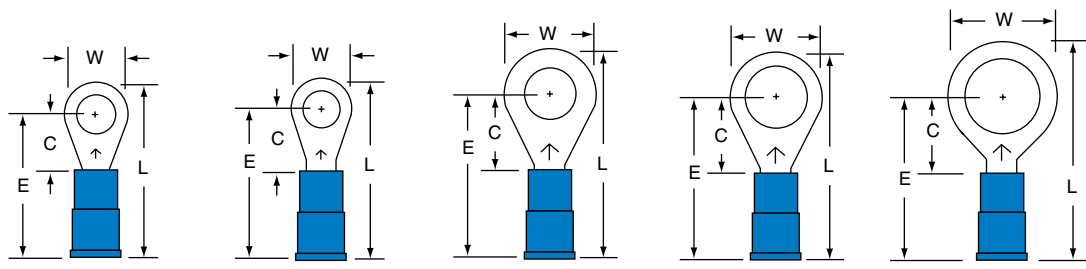

MNG14-10R Stud Size 10 Wire Range 16-14  
 MNG14-10R/L Stud Size 10 Wire Range 16-14  
 MNG14-14R/S Stud Size 1/4 Wire Range 16-14  
 MNG14-516R/S Stud Size 5/16 Wire Range 16-14  
 MNG14-38R Stud Size 3/8 Wire Range 16-14

<sup>1</sup>Product number ending in X = box; product number ending with K = bulk.

# 3M™ Ring Tongues — Nylon Insulated with Insulation Grip 12-10 AWG



| Product Number* | UPC (054007-) | Wire Range (AWG) | Stud Size | W    | C    | L    | E    | Thickness | Barrel Length | Barrel I.D. | Maximum Insulation Diameter | Terminals per Carton | Case |
|-----------------|---------------|------------------|-----------|------|------|------|------|-----------|---------------|-------------|-----------------------------|----------------------|------|
| MNG10-4R/SK     | 01932         | 12-10            | 4         | 0.28 | 0.29 | 0.98 | 0.84 | 0.040     | 0.25          | 0.135       | 0.250                       | —                    | 500  |
| MNG10-6RX       | 23425         | 12-10            | 6         | 0.38 | 0.29 | 1.03 | 0.84 | 0.040     | 0.25          | 0.135       | 0.250                       | 50                   | 500  |
| MNG10-6RK       | 01934         | 12-10            | 6         | 0.38 | 0.29 | 1.03 | 0.84 | 0.040     | 0.25          | 0.135       | 0.250                       | —                    | 500  |
| MNG10-8RX       | 23433         | 12-10            | 8         | 0.38 | 0.29 | 1.03 | 0.84 | 0.040     | 0.25          | 0.135       | 0.250                       | 50                   | 500  |
| MNG10-8RK       | 01936         | 12-10            | 8         | 0.38 | 0.29 | 1.03 | 0.84 | 0.040     | 0.25          | 0.135       | 0.250                       | —                    | 500  |
| MNG10-10RX      | 23441         | 12-10            | 10        | 0.38 | 0.29 | 1.03 | 0.84 | 0.040     | 0.25          | 0.135       | 0.250                       | 50                   | 500  |
| MNG10-10RK      | 01937         | 12-10            | 10        | 0.38 | 0.29 | 1.03 | 0.84 | 0.040     | 0.25          | 0.135       | 0.250                       | —                    | 500  |
| MNG10-14R/SX    | 23458         | 12-10            | 1/4       | 0.53 | 0.44 | 1.26 | 0.99 | 0.040     | 0.25          | 0.135       | 0.250                       | 50                   | 500  |
| MNG10-14R/SK    | 01938         | 12-10            | 1/4       | 0.53 | 0.44 | 1.26 | 0.99 | 0.040     | 0.25          | 0.135       | 0.250                       | —                    | 500  |
| MNG10-516R/SX   | 49640         | 12-10            | 5/16      | 0.53 | 0.44 | 1.26 | 0.99 | 0.040     | 0.25          | 0.135       | 0.250                       | 50                   | 500  |
| MNG10-516R/SK   | 01940         | 12-10            | 5/16      | 0.53 | 0.44 | 1.26 | 0.99 | 0.040     | 0.25          | 0.135       | 0.250                       | —                    | 500  |
| MNG10-38R/SX    | 49641         | 12-10            | 3/8       | 0.54 | 0.44 | 1.26 | 0.99 | 0.040     | 0.25          | 0.135       | 0.250                       | 50                   | 500  |
| MNG10-38R/SK    | 01942         | 12-10            | 3/8       | 0.54 | 0.44 | 1.26 | 0.99 | 0.040     | 0.25          | 0.135       | 0.250                       | —                    | 500  |

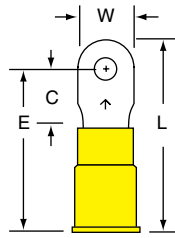

MNG10-4R/S

Stud Size

4

Wire Range

12-10

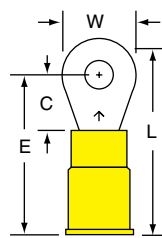

MNG10-6R

6

12-10

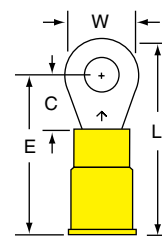

MNG10-8R

8

12-10

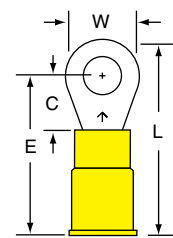

MNG10-10R

10

12-10

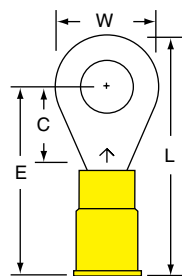

MNG10-14R/S

Stud Size

1/4

Wire Range

12-10

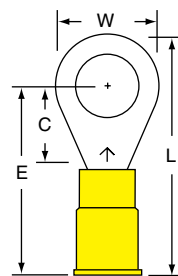

MNG10-516R/S

5/16

12-10

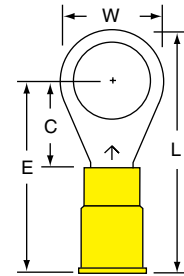

MNG10-38R/S

3/8

12-10

\*Product number ending in X = box; product number ending with K = bulk.

## 3M™ Ring Tongues — Heat Shrink Brazed Seam 22-18 AWG



| Product Number <sup>1</sup> | UPC (054007-) | Wire Range (AWG) | Stud Size | W    | C    | L    | E    | Thickness | Barrel Length | Barrel I.D. | Terminals per: Carton | Case |
|-----------------------------|---------------|------------------|-----------|------|------|------|------|-----------|---------------|-------------|-----------------------|------|
| MH18-6R/LX                  | 06344         | 22-18            | 6         | 0.31 | 0.15 | 1.00 | 0.84 | 0.030     | 0.25          | 0.070       | 25                    | 100  |
| MH18-6R/LK                  | 06345         | 22-18            | 6         | 0.31 | 0.15 | 1.00 | 0.84 | 0.030     | 0.25          | 0.070       | —                     | 250  |
| MH18-8R/LX                  | 06348         | 22-18            | 8         | 0.31 | 0.18 | 1.00 | 0.84 | 0.030     | 0.25          | 0.070       | 25                    | 100  |
| MH18-8R/LK                  | 06349         | 22-18            | 8         | 0.31 | 0.18 | 1.00 | 0.84 | 0.030     | 0.25          | 0.070       | —                     | 250  |
| MH18-10R/LX                 | 06350         | 22-18            | 10        | 0.31 | 0.20 | 1.00 | 0.84 | 0.030     | 0.25          | 0.070       | 25                    | 100  |
| MH18-10R/LK                 | 06351         | 22-18            | 10        | 0.31 | 0.20 | 1.00 | 0.84 | 0.030     | 0.25          | 0.070       | —                     | 250  |

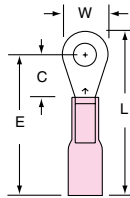

MH18-6R/L

Stud Size

6

Wire Range

22-18

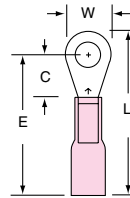

MH18-8R/L

8

22-18

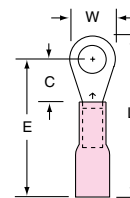

MH18-10R/L

10

22-18

## 3M™ Ring Tongues — Heat Shrink Brazed Seam 16-14 AWG



| Product Number <sup>1</sup> | UPC (054007-) | Wire Range (AWG) | Stud Size | W    | C    | L    | E    | Thickness | Barrel Length | Barrel I.D. | Terminals per: Carton | Case |
|-----------------------------|---------------|------------------|-----------|------|------|------|------|-----------|---------------|-------------|-----------------------|------|
| MH14-6R/LX                  | 06320         | 16-14            | 6         | 0.31 | 0.15 | 1.00 | 0.84 | 0.030     | 0.25          | 0.090       | 25                    | 100  |
| MH14-6R/LK                  | 06321         | 16-14            | 6         | 0.31 | 0.15 | 1.00 | 0.84 | 0.030     | 0.25          | 0.090       | —                     | 250  |
| MH14-8R/LX                  | 06324         | 16-14            | 8         | 0.31 | 0.18 | 1.00 | 0.84 | 0.030     | 0.25          | 0.090       | 25                    | 100  |
| MH14-8R/LK                  | 06325         | 16-14            | 8         | 0.31 | 0.18 | 1.00 | 0.84 | 0.030     | 0.25          | 0.090       | —                     | 250  |
| MH14-10R/LX                 | 06326         | 16-14            | 10        | 0.31 | 0.20 | 1.00 | 0.84 | 0.030     | 0.25          | 0.090       | 25                    | 100  |
| MH14-10R/LK                 | 06327         | 16-14            | 10        | 0.31 | 0.20 | 1.00 | 0.84 | 0.030     | 0.25          | 0.090       | —                     | 250  |
| MH14-14R/SX                 | 06330         | 16-14            | 1/4       | 0.47 | 0.26 | 1.1  | 0.86 | 0.030     | 0.25          | 0.090       | 25                    | 100  |
| MH14-14R/SK                 | 06331         | 16-14            | 1/4       | 0.47 | 0.26 | 1.1  | 0.86 | 0.030     | 0.25          | 0.090       | —                     | 250  |
| MH14-516R/SX                | 06336         | 16-14            | 5/16      | 0.47 | 0.33 | 1.1  | 0.86 | 0.030     | 0.25          | 0.090       | 25                    | 100  |
| MH14-38RX                   | 06334         | 16-14            | 3/8       | 0.56 | 0.28 | 1.1  | 0.87 | 0.030     | 0.25          | 0.090       | 25                    | 100  |
| MH14-38RK                   | 06335         | 16-14            | 3/8       | 0.56 | 0.28 | 1.1  | 0.87 | 0.030     | 0.25          | 0.090       | —                     | 250  |

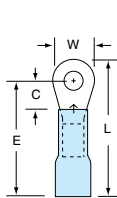

MH14-6R/L

Stud Size

6

Wire Range

16-14

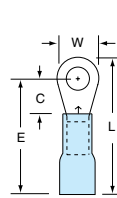

MH14-8R/L

8

16-14

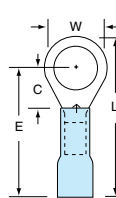

MH14-10R/L

10

16-14

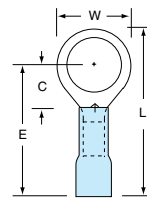

MH14-14R/S

1/4

16-14

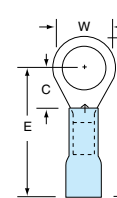

MH14-516R/S

5/16

16-14

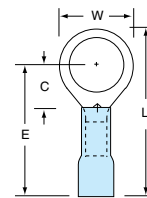

MH14-38R

3/8

16-14

<sup>1</sup>Product number ending in X = box; product number ending with K = bulk.

# 3M™ Ring Tongues — Heat Shrink Brazed Seam 12-10



| Product Number* | UPC (054007-) | Wire Range (AWG) | Stud Size | W    | C    | L   | E    | Thickness | Barrel Length | Barrel I.D. | Terminals per: Carton | Case |
|-----------------|---------------|------------------|-----------|------|------|-----|------|-----------|---------------|-------------|-----------------------|------|
| MH10-8RX        | 06302         | 12-10            | 8         | 0.38 | 0.19 | 1.1 | 0.91 | 0.040     | 0.25          | 0.135       | 25                    | 100  |
| MH10-10RX       | 06305         | 12-10            | 10        | 0.38 | 0.21 | 1.1 | 0.91 | 0.040     | 0.25          | 0.135       | 25                    | 100  |
| MH10-10RK       | 06306         | 12-10            | 10        | 0.38 | 0.21 | 1.1 | 0.91 | 0.040     | 0.25          | 0.135       | —                     | 250  |
| MH10-14RX       | 06309         | 12-10            | 1/4       | 0.59 | 0.29 | 1.2 | 0.90 | 0.040     | 0.25          | 0.135       | 25                    | 100  |
| MH10-14RK       | 06359         | 12-10            | 1/4       | 0.59 | 0.29 | 1.2 | 0.90 | 0.040     | 0.25          | 0.135       | —                     | 250  |
| MH10-38RX       | 06312         | 12-10            | 3/8       | 0.59 | 0.29 | 1.2 | 0.90 | 0.040     | 0.25          | 0.135       | 25                    | 100  |
| MH10-38RK       | 06313         | 12-10            | 3/8       | 0.59 | 0.29 | 1.2 | 0.90 | 0.040     | 0.25          | 0.135       | —                     | 250  |

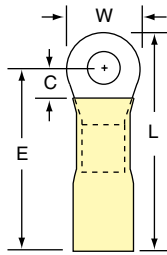

MH10-8R

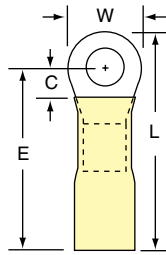

MH10-10R

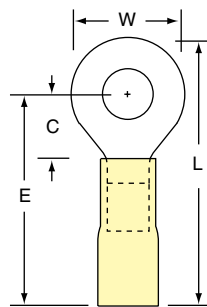

MH10-14R

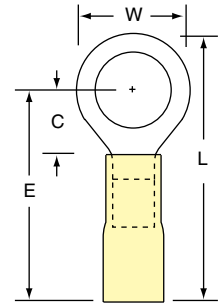

MH10-38R

Stud Size

8

10

1/4

3/8

Wire Range

12-10

12-10

12-10

12-10

\*Product number ending in X = box; product number ending with K = bulk.

# Multi-Stud Ring Tongues

## 3M™ Multi-Stud Ring Tongues — Vinyl Insulated Brazed Seam



| Product Number | UPC (054007-) | Wire Range (AWG) | Stud Size | W    | C    | L    | E    | Thickness | Barrel Length | Barrel I.D. | Maximum Insulation Diameter | Terminals per: Carton | Case |
|----------------|---------------|------------------|-----------|------|------|------|------|-----------|---------------|-------------|-----------------------------|-----------------------|------|
| MV18-610RX     | 14093         | 22-18            | 6/8/10    | 0.34 | 0.31 | 1.01 | 0.76 | 0.030     | 0.25          | 0.070       | 0.145                       | 100                   | 500  |
| MV18-610RK     | 01342         | 22-18            | 6/8/10    | 0.34 | 0.31 | 1.01 | 0.76 | 0.030     | 0.25          | 0.070       | 0.145                       | —                     | 1000 |
| MV14-610RX     | 14119         | 16-14            | 6/8/10    | 0.34 | 0.31 | 1.01 | 0.76 | 0.030     | 0.25          | 0.090       | 0.170                       | 100                   | 500  |
| MV14-610RK     | 01851         | 16-14            | 6/8/10    | 0.34 | 0.31 | 1.01 | 0.76 | 0.030     | 0.25          | 0.090       | 0.170                       | —                     | 1000 |
| MV10-610RX     | 14127         | 12-10            | 6/8/10    | 0.39 | 0.35 | 1.19 | 0.80 | 0.040     | 0.25          | 0.135       | 0.250                       | 50                    | 500  |
| MV10-610RK     | 02099         | 12-10            | 6/8/10    | 0.39 | 0.35 | 1.19 | 0.80 | 0.040     | 0.25          | 0.135       | 0.250                       | —                     | 500  |

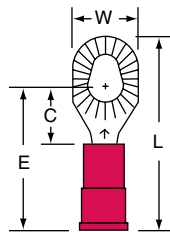

MV18-610R

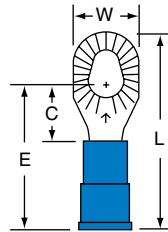

MV14-610R

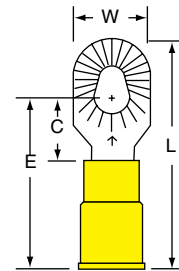

MV10-610R

Stud Size

6/8/10

6/8/10

6/8/10

Wire Range

22-18

16-14

12-10

## 3M™ Multi-Stud Ring Tongues — Nylon Insulated with Insulation Grip



| Product Number | UPC (054007-) | Wire Range (AWG) | Stud Size | W    | C    | L    | E    | Thickness | Barrel Length | Barrel I.D. | Maximum Insulation Diameter | Terminals per: Carton | Case |
|----------------|---------------|------------------|-----------|------|------|------|------|-----------|---------------|-------------|-----------------------------|-----------------------|------|
| MNG18-610RX    | 49611         | 22-18            | 6/8/10    | 0.34 | 0.31 | 1.00 | 0.75 | 0.030     | 0.25          | 0.070       | 0.145                       | 100                   | 500  |
| MNG18-610RK    | 01344         | 22-18            | 6/8/10    | 0.34 | 0.31 | 1.00 | 0.75 | 0.030     | 0.25          | 0.070       | 0.145                       | —                     | 1000 |
| MNG14-610RX    | 49636         | 16-14            | 6/8/10    | 0.34 | 0.31 | 1.02 | 0.77 | 0.030     | 0.25          | 0.090       | 0.170                       | 100                   | 500  |
| MNG14-610RK    | 01853         | 16-14            | 6/8/10    | 0.34 | 0.31 | 1.02 | 0.77 | 0.030     | 0.25          | 0.090       | 0.170                       | —                     | 1000 |
| MNG10-610RX    | 49646         | 12-10            | 6/8/10    | 0.39 | 0.35 | 1.19 | 0.80 | 0.040     | 0.25          | 0.135       | 0.250                       | 50                    | 100  |
| MNG10-610RK    | 02100         | 12-10            | 6/8/10    | 0.39 | 0.35 | 1.19 | 0.80 | 0.040     | 0.25          | 0.135       | 0.250                       | —                     | 500  |

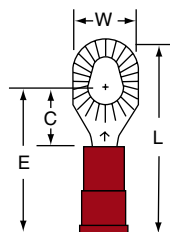

MNG18-610R

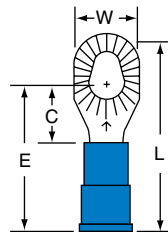

MNG14-610R

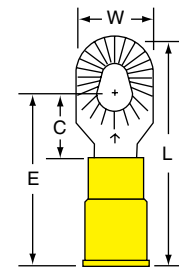

MNG10-610R

Stud Size

6/8/10

6/8/10

6/8/10

Wire Range

22-18

16-14

12-10

\*Product number ending in X = box; product number ending with K = bulk.



# Standard Forks

## 3M™ Standard Forks — Non-Insulated Brazed Seam



| Product Number | UPC (054007-) | Wire Range (AWG) | Stud Size | W    | C    | L    | E    | Thickness | Barrel Length | Barrel I.D. | Terminals per: Carton | Case |
|----------------|---------------|------------------|-----------|------|------|------|------|-----------|---------------|-------------|-----------------------|------|
| M18-6FX        | 21858         | 22-18            | 6         | 0.34 | 0.29 | 0.70 | 0.54 | 0.030     | 0.25          | 0.070       | 100                   | 500  |
| M18-6FK        | 01150         | 22-18            | 6         | 0.34 | 0.29 | 0.70 | 0.54 | 0.030     | 0.25          | 0.070       | —                     | 1000 |
| M18-8FX        | 21866         | 22-18            | 8         | 0.34 | 0.29 | 0.70 | 0.54 | 0.030     | 0.25          | 0.070       | 100                   | 500  |
| M18-8FK        | 01152         | 22-18            | 8         | 0.34 | 0.29 | 0.70 | 0.54 | 0.030     | 0.25          | 0.070       | —                     | 1000 |
| M18-10FX       | 49599         | 22-18            | 10        | 0.34 | 0.29 | 0.70 | 0.54 | 0.030     | 0.25          | 0.070       | 100                   | 500  |
| M18-10FK       | 01154         | 22-18            | 10        | 0.34 | 0.29 | 0.70 | 0.54 | 0.030     | 0.25          | 0.070       | —                     | 1000 |
| M14-6FX        | 49622         | 16-14            | 6         | 0.34 | 0.29 | 0.70 | 0.54 | 0.030     | 0.25          | 0.090       | 100                   | 500  |
| M14-6FK        | 01516         | 16-14            | 6         | 0.34 | 0.29 | 0.70 | 0.54 | 0.030     | 0.25          | 0.090       | —                     | 1000 |
| M14-8FK        | 01518         | 16-14            | 8         | 0.34 | 0.29 | 0.70 | 0.54 | 0.030     | 0.25          | 0.090       | —                     | 1000 |
| M14-10FX       | 22542         | 16-14            | 10        | 0.34 | 0.29 | 0.70 | 0.54 | 0.030     | 0.25          | 0.090       | 100                   | 500  |
| M14-10FK       | 01520         | 16-14            | 10        | 0.34 | 0.29 | 0.70 | 0.54 | 0.030     | 0.25          | 0.090       | —                     | 1000 |
| M10-6FK        | 01972         | 12-10            | 6         | 0.38 | 0.29 | 0.73 | 0.54 | 0.040     | 0.25          | 0.135       | —                     | 500  |
| M10-8FX        | 23581         | 12-10            | 8         | 0.38 | 0.29 | 0.73 | 0.54 | 0.040     | 0.25          | 0.135       | 50                    | 500  |
| M10-8FK        | 01973         | 12-10            | 8         | 0.38 | 0.29 | 0.73 | 0.54 | 0.040     | 0.25          | 0.135       | —                     | 500  |
| M10-10FX       | 23599         | 12-10            | 10        | 0.38 | 0.29 | 0.73 | 0.54 | 0.040     | 0.25          | 0.135       | 50                    | 500  |
| M10-10FK       | 01974         | 12-10            | 10        | 0.38 | 0.29 | 0.73 | 0.54 | 0.040     | 0.25          | 0.135       | —                     | 500  |

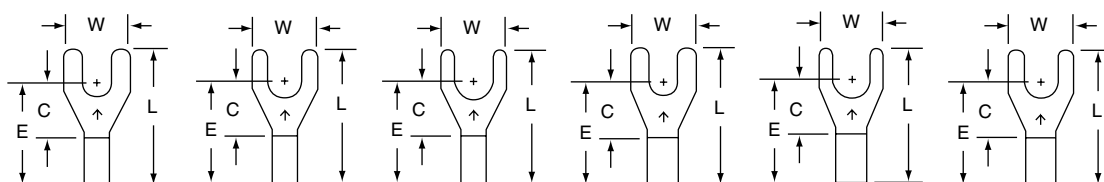

M18-6F      M18-8F      M18-10F      M14-6F      M14-8F      M14-10F

|            |       |       |       |       |       |       |
|------------|-------|-------|-------|-------|-------|-------|
| Stud Size  | 6     | 8     | 10    | 6     | 8     | 10    |
| Wire Range | 22-18 | 22-18 | 22-18 | 16-14 | 16-14 | 16-14 |

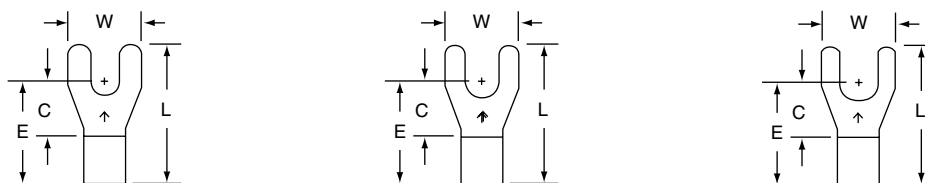

M10-6F      M10-8F      M10-10F

|            |       |       |       |
|------------|-------|-------|-------|
| Stud Size  | 6     | 8     | 10    |
| Wire Range | 12-10 | 12-10 | 12-10 |

\*Product number ending in X = box; product number ending with K = bulk.

# 3M™ Standard Forks — Non-Insulated Butted Seam



| Product Number* | UPC (054007-) | Wire Range (AWG) | Stud Size | W    | C    | L    | E    | Thickness | Barrel Length | Barrel I.D. | Maximum Insulation Diameter | Terminals per Case |
|-----------------|---------------|------------------|-----------|------|------|------|------|-----------|---------------|-------------|-----------------------------|--------------------|
| MU18-6FK        | 01144         | 22-18            | 6         | 0.34 | 0.29 | 0.70 | 0.54 | 0.030     | 0.25          | 0.070       | 1000                        |                    |
| MU18-8FK        | 01146         | 22-18            | 8         | 0.34 | 0.29 | 0.70 | 0.54 | 0.030     | 0.25          | 0.070       | 1000                        |                    |
| MU14-8FK        | 01512         | 16-14            | 8         | 0.34 | 0.29 | 0.70 | 0.54 | 0.030     | 0.25          | 0.090       | 1000                        |                    |
| MU14-10FK       | 01514         | 16-14            | 10        | 0.34 | 0.29 | 0.70 | 0.54 | 0.030     | 0.25          | 0.090       | 1000                        |                    |
| MU10-8FK        | 01970         | 12-10            | 8         | 0.38 | 0.29 | 0.73 | 0.54 | 0.040     | 0.25          | 0.135       | 500                         |                    |
| MU10-10FK       | 01971         | 12-10            | 10        | 0.38 | 0.29 | 0.73 | 0.54 | 0.040     | 0.25          | 0.135       | 500                         |                    |

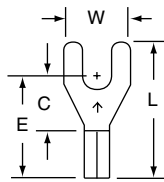

MU18-6F

Stud Size

6

Wire Range

22-18

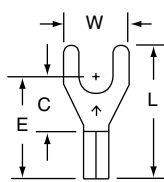

MU18-8F

8

22-18

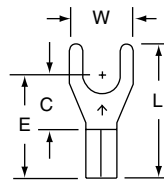

MU14-8F

8

16-14

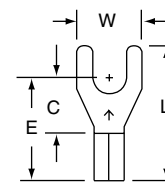

MU14-10F

10

16-14

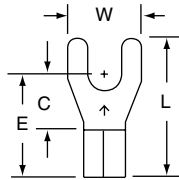

MU10-8F

Stud Size

8

Wire Range

12-10

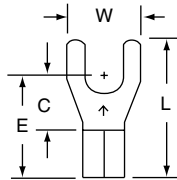

MU10-10F

10

12-10

\*Product number ending in X = box; product number ending with K = bulk.

# 3M™ Standard Forks — Vinyl Insulated Brazed Seam



| Product Number* | UPC (054007-) | Wire Range (AWG) | Stud Size | W    | C    | L    | E    | Thickness | Barrel Length | Barrel I.D. | Maximum Insulation Diameter | Terminals per: Carton | Case |
|-----------------|---------------|------------------|-----------|------|------|------|------|-----------|---------------|-------------|-----------------------------|-----------------------|------|
| MV18-6FX        | 21882         | 22-18            | 6         | 0.34 | 0.29 | 0.90 | 0.74 | 0.030     | 0.25          | 0.070       | 0.145                       | 100                   | 500  |
| MV18-6FK        | 01162         | 22-18            | 6         | 0.34 | 0.29 | 0.90 | 0.74 | 0.030     | 0.25          | 0.070       | 0.145                       | —                     | 1000 |
| MV18-8FX        | 21890         | 22-18            | 8         | 0.34 | 0.29 | 0.90 | 0.74 | 0.030     | 0.25          | 0.070       | 0.145                       | 100                   | 500  |
| MV18-8FK        | 01164         | 22-18            | 8         | 0.34 | 0.29 | 0.90 | 0.74 | 0.030     | 0.25          | 0.070       | 0.145                       | —                     | 1000 |
| MV18-10FX       | 21908         | 22-18            | 10        | 0.34 | 0.29 | 0.90 | 0.74 | 0.030     | 0.25          | 0.070       | 0.145                       | 100                   | 500  |
| MV18-10FK       | 01166         | 22-18            | 10        | 0.34 | 0.29 | 0.90 | 0.74 | 0.030     | 0.25          | 0.070       | 0.145                       | —                     | 1000 |
| MV14-6FX        | 22559         | 16-14            | 6         | 0.34 | 0.29 | 0.90 | 0.74 | 0.030     | 0.25          | 0.090       | 0.170                       | 100                   | 500  |
| MV14-6FK        | 01528         | 16-14            | 6         | 0.34 | 0.29 | 0.90 | 0.74 | 0.030     | 0.25          | 0.090       | 0.170                       | —                     | 1000 |
| MV14-8FX        | 22567         | 16-14            | 8         | 0.34 | 0.29 | 0.90 | 0.74 | 0.030     | 0.25          | 0.090       | 0.170                       | 100                   | 500  |
| MV14-8FK        | 01530         | 16-14            | 8         | 0.34 | 0.29 | 0.90 | 0.74 | 0.030     | 0.25          | 0.090       | 0.170                       | —                     | 1000 |
| MV14-10FX       | 22575         | 16-14            | 10        | 0.34 | 0.29 | 0.90 | 0.74 | 0.030     | 0.25          | 0.090       | 0.170                       | 100                   | 500  |
| MV14-10FK       | 01532         | 16-14            | 10        | 0.34 | 0.29 | 0.90 | 0.74 | 0.030     | 0.25          | 0.090       | 0.170                       | —                     | 1000 |
| MV10-6FX        | 23607         | 12-10            | 6         | 0.38 | 0.29 | 1.03 | 0.84 | 0.040     | 0.25          | 0.135       | 0.250                       | 50                    | 500  |
| MV10-6FK        | 01978         | 12-10            | 6         | 0.38 | 0.29 | 1.03 | 0.84 | 0.040     | 0.25          | 0.135       | 0.250                       | —                     | 500  |
| MV10-8FX        | 23615         | 12-10            | 8         | 0.38 | 0.29 | 1.03 | 0.84 | 0.040     | 0.25          | 0.135       | 0.250                       | 50                    | 500  |
| MV10-8FK        | 01979         | 12-10            | 8         | 0.38 | 0.29 | 1.03 | 0.84 | 0.040     | 0.25          | 0.135       | 0.250                       | —                     | 500  |
| MV10-10FX       | 23623         | 12-10            | 10        | 0.38 | 0.29 | 1.03 | 0.84 | 0.040     | 0.25          | 0.135       | 0.250                       | 50                    | 500  |
| MV10-10FK       | 01980         | 12-10            | 10        | 0.38 | 0.29 | 1.03 | 0.84 | 0.040     | 0.25          | 0.135       | 0.250                       | —                     | 500  |

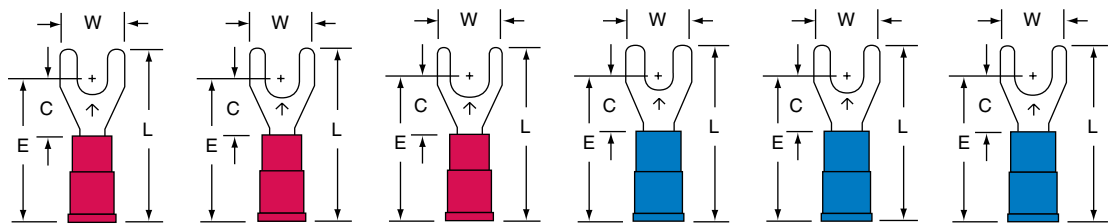

MV18-6F      MV18-8F      MV18-10F      MV14-6F      MV14-8F      MV14-10F

Stud Size                    6                    8                    10                    6                    8                    10  
 Wire Range                22-18              22-18              22-18              16-14              16-14              16-14

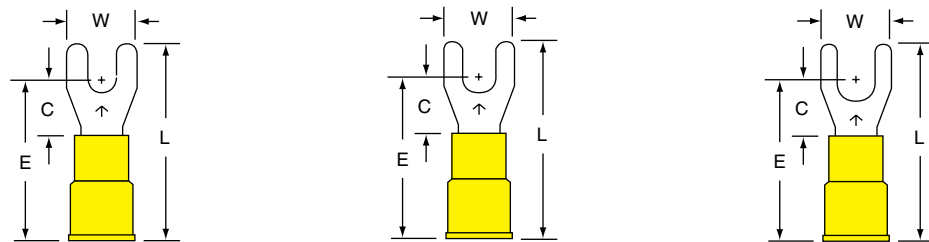

MV10-6F                    MV10-8F                    MV10-10F

Stud Size                    6                    8                    10  
 Wire Range                12-10              12-10              12-10

\*Product number ending in X = box; product number ending with K = bulk.

# 3M™ Standard Forks — Vinyl Insulated Butted Seam



| Product Number* | UPC (054007-) | Wire Range (AWG) | Stud Size | W    | C    | L    | E    | Thickness | Barrel Length | Barrel I.D. | Maximum Insulation Diameter | Terminals per: Carton Case |
|-----------------|---------------|------------------|-----------|------|------|------|------|-----------|---------------|-------------|-----------------------------|----------------------------|
| MVU18-6FK       | 01174         | 22-18            | 6         | 0.34 | 0.29 | 0.90 | 0.74 | 0.030     | 0.25          | 0.070       | 0.145                       | 1000                       |
| MVU18-8FK       | 01176         | 22-18            | 8         | 0.34 | 0.29 | 0.90 | 0.74 | 0.030     | 0.25          | 0.070       | 0.145                       | 1000                       |
| MVU18-10FK      | 01178         | 22-18            | 10        | 0.34 | 0.29 | 0.90 | 0.74 | 0.030     | 0.25          | 0.070       | 0.145                       | 1000                       |
| MVU14-6FK       | 01540         | 16-14            | 6         | 0.34 | 0.29 | 0.90 | 0.74 | 0.030     | 0.25          | 0.090       | 0.170                       | 1000                       |
| MVU14-8FK       | 01542         | 16-14            | 8         | 0.34 | 0.29 | 0.90 | 0.74 | 0.030     | 0.25          | 0.090       | 0.170                       | 1000                       |
| MVU14-10FK      | 01544         | 16-14            | 10        | 0.34 | 0.29 | 0.90 | 0.74 | 0.030     | 0.25          | 0.090       | 0.170                       | 1000                       |
| MVU10-6FK       | 01984         | 12-10            | 6         | 0.38 | 0.29 | 1.03 | 0.84 | 0.040     | 0.25          | 0.135       | 0.250                       | 500                        |
| MVU10-8FK       | 01985         | 12-10            | 8         | 0.38 | 0.29 | 1.03 | 0.84 | 0.040     | 0.25          | 0.135       | 0.250                       | 500                        |
| MVU10-10FK      | 01986         | 12-10            | 10        | 0.38 | 0.29 | 1.03 | 0.84 | 0.040     | 0.25          | 0.135       | 0.250                       | 500                        |

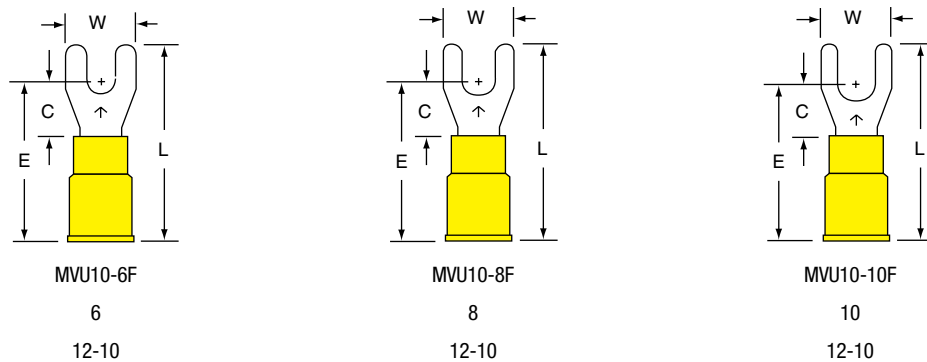
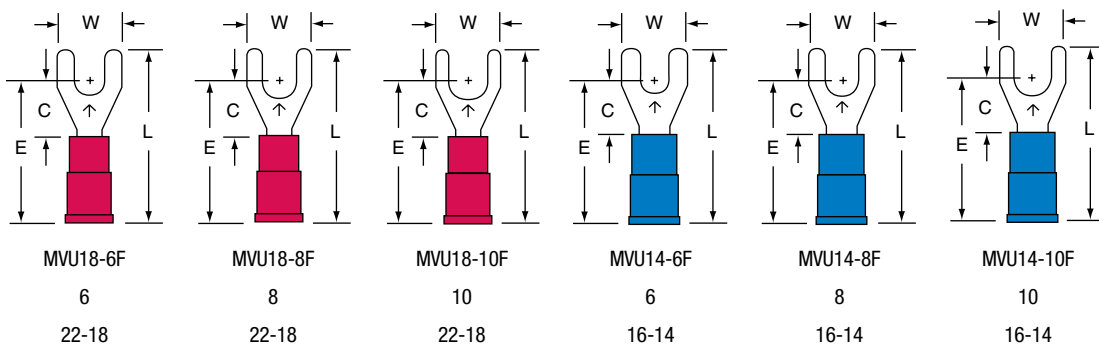

\*Product number ending in X = box; product number ending with K = bulk.

# 3M™ Standard Forks — Nylon Insulated with Insulation Grip



| Product Number* | UPC (054007-) | Wire Range (AWG) | Stud Size | W    | C    | L    | E    | Thickness | Barrel Length | Barrel I.D. | Maximum Insulation Diameter | Terminals per Carton | Case |
|-----------------|---------------|------------------|-----------|------|------|------|------|-----------|---------------|-------------|-----------------------------|----------------------|------|
| MNG18-6FX       | 21916         | 22-18            | 6         | 0.34 | 0.29 | 0.89 | 0.73 | 0.030     | 0.25          | 0.070       | 0.145                       | 100                  | 500  |
| MNG18-6FK       | 01168         | 22-18            | 6         | 0.34 | 0.29 | 0.89 | 0.73 | 0.030     | 0.25          | 0.070       | 0.145                       | —                    | 1000 |
| MNG18-8FX       | 21924         | 22-18            | 8         | 0.34 | 0.29 | 0.89 | 0.73 | 0.030     | 0.25          | 0.070       | 0.145                       | 100                  | 500  |
| MNG18-8FK       | 01170         | 22-18            | 8         | 0.34 | 0.29 | 0.89 | 0.73 | 0.030     | 0.25          | 0.070       | 0.145                       | —                    | 1000 |
| MNG18-10FK      | 01172         | 22-18            | 10        | 0.34 | 0.29 | 0.89 | 0.73 | 0.030     | 0.25          | 0.070       | 0.145                       | —                    | 1000 |
| MNG14-6FX       | 22583         | 16-14            | 6         | 0.34 | 0.29 | 0.91 | 0.75 | 0.030     | 0.25          | 0.090       | 0.170                       | 100                  | 500  |
| MNG14-6FK       | 01534         | 16-14            | 6         | 0.34 | 0.29 | 0.91 | 0.75 | 0.030     | 0.25          | 0.090       | 0.170                       | —                    | 1000 |
| MNG14-8FX       | 22591         | 16-14            | 8         | 0.34 | 0.29 | 0.91 | 0.75 | 0.030     | 0.25          | 0.090       | 0.170                       | 100                  | 500  |
| MNG14-8FK       | 01536         | 16-14            | 8         | 0.34 | 0.29 | 0.91 | 0.75 | 0.030     | 0.25          | 0.090       | 0.170                       | —                    | 1000 |
| MNG14-10FX      | 22609         | 16-14            | 10        | 0.34 | 0.29 | 0.91 | 0.75 | 0.030     | 0.25          | 0.090       | 0.170                       | 100                  | 500  |
| MNG14-10FK      | 01538         | 16-14            | 10        | 0.34 | 0.29 | 0.91 | 0.75 | 0.030     | 0.25          | 0.090       | 0.170                       | —                    | 1000 |
| MNG10-6FK       | 01981         | 12-10            | 6         | 0.38 | 0.29 | 1.03 | 0.84 | 0.040     | 0.25          | 0.135       | 0.250                       | —                    | 500  |
| MNG10-8FX       | 23649         | 12-10            | 8         | 0.38 | 0.29 | 1.03 | 0.84 | 0.040     | 0.25          | 0.135       | 0.250                       | 50                   | 500  |
| MNG10-8FK       | 01982         | 12-10            | 8         | 0.38 | 0.29 | 1.03 | 0.84 | 0.040     | 0.25          | 0.135       | 0.250                       | —                    | 500  |
| MNG10-10FX      | 23656         | 12-10            | 10        | 0.38 | 0.29 | 1.03 | 0.84 | 0.040     | 0.25          | 0.135       | 0.250                       | 50                   | 500  |
| MNG10-10FK      | 01983         | 12-10            | 10        | 0.38 | 0.29 | 1.03 | 0.84 | 0.040     | 0.25          | 0.135       | 0.250                       | —                    | 500  |

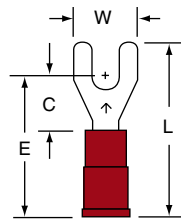

MNG18-6F

Stud Size

6

Wire Range

22-18

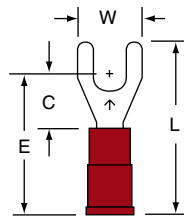

MNG18-8F

8

22-18

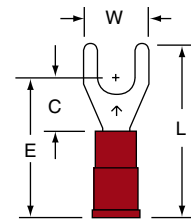

MNG18-10F

10

22-18

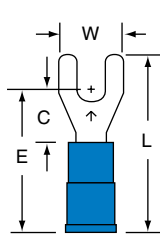

MNG14-6F

Stud Size

6

Wire Range

16-14

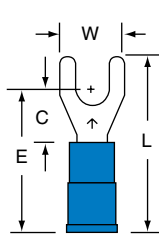

MNG14-8F

8

16-14

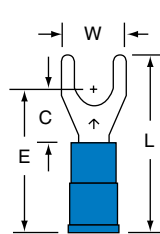

MNG14-10F

10

16-14

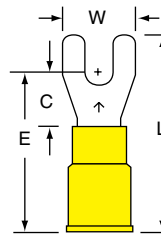

MNG10-6F

6

12-10

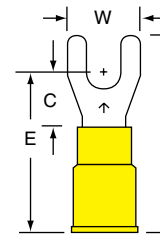

MNG10-8F

8

12-10

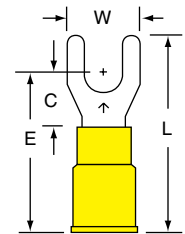

MNG10-10F

10

12-10

\*Product number ending in X = box; product number ending with K = bulk.

## 3M™ Standard Forks — Nylon Insulated

| Product Number* | UPC (054007-) | Wire Range (AWG) | Stud Size | W    | C    | L    | E    | Thickness | Barrel Length | Barrel I.D. | Maximum Insulation Diameter | Terminals per: Carton | Case |
|-----------------|---------------|------------------|-----------|------|------|------|------|-----------|---------------|-------------|-----------------------------|-----------------------|------|
| MN24-4FX*       | 95166         | 26-24            | 4         | 0.20 | 0.21 | 0.61 | 0.49 | 0.020     | 0.14          | 0.030       | 0.093                       | 100                   | 500  |
| MN24-4FK*       | 95165         | 26-24            | 4         | 0.20 | 0.21 | 0.61 | 0.49 | 0.020     | 0.14          | 0.030       | 0.093                       | —                     | 1000 |
| MN24-6FX*       | 95172         | 26-24            | 6         | 0.25 | 0.28 | 0.69 | 0.56 | 0.020     | 0.13          | 0.030       | 0.093                       | 100                   | 500  |
| MN24-6FK*       | 95171         | 26-24            | 6         | 0.25 | 0.28 | 0.69 | 0.56 | 0.020     | 0.13          | 0.030       | 0.093                       | —                     | 1000 |

\* Not UL Listed or CSA Certified

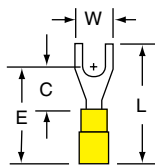

MN24-4F

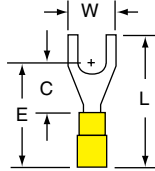

MN24-6F

Stud Size

4

6

Wire Range

26-24

26-24

\*Product number ending in X = box; product number ending with K = bulk.

# Block Forks

## 3M™ Block Forks — Non-Insulated Brazed Seam 22-18 AWG



| Product Number <sup>1</sup> | UPC (054007-) | Wire Range (AWG) | Stud Size | W    | C    | L    | E    | Thickness | Barrel Length | Barrel I.D. | Terminals per Carton | Terminals per Case |
|-----------------------------|---------------|------------------|-----------|------|------|------|------|-----------|---------------|-------------|----------------------|--------------------|
| M18-4FB/SK                  | 02248         | 22-18            | 4         | 0.25 | 0.25 | 0.65 | 0.50 | 0.030     | 0.25          | 0.070       | —                    | 1000               |
| M18-6FB/SX                  | 49600         | 22-18            | 6         | 0.25 | 0.25 | 0.65 | 0.50 | 0.030     | 0.25          | 0.070       | 100                  | 500                |
| M18-6FB/SK                  | 01202         | 22-18            | 6         | 0.25 | 0.25 | 0.65 | 0.50 | 0.030     | 0.25          | 0.070       | —                    | 1000               |
| M18-6FBX                    | 21940         | 22-18            | 6         | 0.30 | 0.25 | 0.65 | 0.50 | 0.030     | 0.25          | 0.070       | 100                  | 500                |
| M18-6FBK                    | 01203         | 22-18            | 6         | 0.30 | 0.25 | 0.65 | 0.50 | 0.030     | 0.25          | 0.070       | —                    | 1000               |
| M18-8FBX                    | 21957         | 22-18            | 8         | 0.30 | 0.25 | 0.65 | 0.50 | 0.030     | 0.25          | 0.070       | 100                  | 500                |
| M18-8FBK                    | 01204         | 22-18            | 8         | 0.30 | 0.25 | 0.65 | 0.50 | 0.030     | 0.25          | 0.070       | —                    | 1000               |
| M18-10FBX                   | 49601         | 22-18            | 10        | 0.30 | 0.25 | 0.65 | 0.50 | 0.030     | 0.25          | 0.070       | 100                  | 500                |
| M18-10FBK                   | 01205         | 22-18            | 10        | 0.30 | 0.25 | 0.65 | 0.50 | 0.030     | 0.25          | 0.070       | —                    | 1000               |

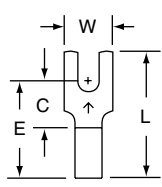

M18-4FB/S

Stud Size 4  
Wire Range 22-18

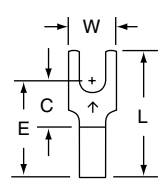

M18-6FB/S

Stud Size 6  
Wire Range 22-18

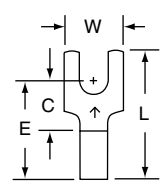

M18-6FB

Stud Size 6  
Wire Range 22-18

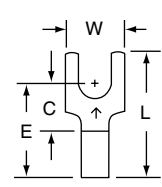

M18-8FB

Stud Size 8  
Wire Range 22-18

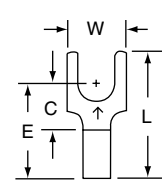

M18-10FB

Stud Size 10  
Wire Range 22-18

## 3M™ Block Forks — Non-Insulated Brazed Seam 16-14 AWG



| Product Number <sup>1</sup> | UPC (054007-) | Wire Range (AWG) | Stud Size | W    | C    | L    | E    | Thickness | Barrel Length | Barrel I.D. | Terminals per Carton | Terminals per Case |
|-----------------------------|---------------|------------------|-----------|------|------|------|------|-----------|---------------|-------------|----------------------|--------------------|
| M14-6FB/SX                  | 49623         | 16-14            | 6         | 0.25 | 0.25 | 0.65 | 0.50 | 0.030     | 0.25          | 0.090       | 100                  | 500                |
| M14-6FB/SK                  | 01568         | 16-14            | 6         | 0.25 | 0.25 | 0.65 | 0.50 | 0.030     | 0.25          | 0.090       | —                    | 1000               |
| M14-6FBX                    | 22617         | 16-14            | 6         | 0.30 | 0.25 | 0.65 | 0.50 | 0.030     | 0.25          | 0.090       | 100                  | 500                |
| M14-6FBK                    | 01569         | 16-14            | 6         | 0.30 | 0.25 | 0.65 | 0.50 | 0.030     | 0.25          | 0.090       | —                    | 1000               |
| M14-8FBX                    | 22625         | 16-14            | 8         | 0.30 | 0.25 | 0.65 | 0.50 | 0.030     | 0.25          | 0.090       | 100                  | 500                |
| M14-8FBK                    | 01570         | 16-14            | 8         | 0.30 | 0.25 | 0.65 | 0.50 | 0.030     | 0.25          | 0.090       | —                    | 1000               |
| M14-10FBX                   | 22633         | 16-14            | 10        | 0.30 | 0.25 | 0.65 | 0.50 | 0.030     | 0.25          | 0.090       | 100                  | 500                |
| M14-10FBK                   | 01571         | 16-14            | 10        | 0.30 | 0.25 | 0.65 | 0.50 | 0.030     | 0.25          | 0.090       | —                    | 1000               |

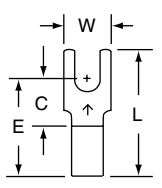

M14-6FB/S

Stud Size 6  
Wire Range 16-14

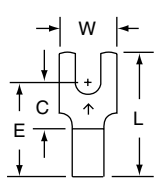

M14-6FB

Stud Size 6  
Wire Range 16-14

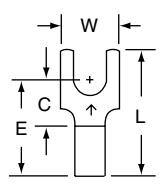

M14-8FB

Stud Size 8  
Wire Range 16-14

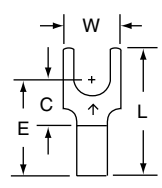

M14-10FB

Stud Size 10  
Wire Range 16-14

<sup>1</sup>Product number ending in X = box; product number ending with K = bulk.

## 3M™ Block Forks — Non-Insulated Brazed Seam 12-10 AWG



| Product Number <sup>1</sup> | UPC (054007-) | Wire Range (AWG) | Stud Size | W    | C    | L    | E    | Thickness | Barrel Length | Barrel I.D. | Terminals per Carton | Case |
|-----------------------------|---------------|------------------|-----------|------|------|------|------|-----------|---------------|-------------|----------------------|------|
| M10-6FBK                    | 02008         | 12-10            | 6         | 0.32 | 0.29 | 0.73 | 0.54 | 0.040     | 0.25          | 0.135       | —                    | 500  |
| M10-8FBX                    | 23672         | 12-10            | 8         | 0.32 | 0.29 | 0.73 | 0.54 | 0.040     | 0.25          | 0.135       | 50                   | 500  |
| M10-8FBK                    | 02009         | 12-10            | 8         | 0.32 | 0.29 | 0.73 | 0.54 | 0.040     | 0.25          | 0.135       | —                    | 500  |
| M10-10FBX                   | 23680         | 12-10            | 10        | 0.32 | 0.29 | 0.73 | 0.54 | 0.040     | 0.25          | 0.135       | 50                   | 500  |
| M10-10FBK                   | 02010         | 12-10            | 10        | 0.32 | 0.29 | 0.73 | 0.54 | 0.040     | 0.25          | 0.135       | —                    | 500  |

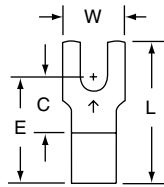

M10-6FB  
6  
12-10

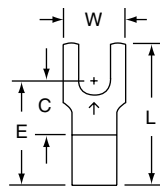

M10-8FB  
8  
12-10

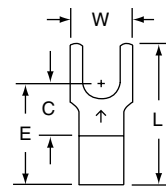

M10-10FB  
10  
12-10

Stud Size  
Wire Range

## 3M™ Block Forks — Non-Insulated Butted Seam 22-18 AWG



| Product Number <sup>1</sup> | UPC (054007-) | Wire Range (AWG) | Stud Size | W    | C    | L    | E    | Thickness | Barrel Length | Barrel I.D. | Terminals per Case |
|-----------------------------|---------------|------------------|-----------|------|------|------|------|-----------|---------------|-------------|--------------------|
| MU18-4FB/SK                 | 02263         | 22-18            | 4         | 0.25 | 0.25 | 0.65 | 0.50 | 0.030     | 0.25          | 0.070       | 1000               |
| MU18-6FB/SK                 | 01198         | 22-18            | 6         | 0.25 | 0.25 | 0.65 | 0.50 | 0.030     | 0.25          | 0.070       | 1000               |
| MU18-6FBK                   | 01199         | 22-18            | 6         | 0.30 | 0.25 | 0.65 | 0.50 | 0.030     | 0.25          | 0.070       | 1000               |
| MU18-8FBK                   | 01200         | 22-18            | 8         | 0.30 | 0.25 | 0.65 | 0.50 | 0.030     | 0.25          | 0.070       | 1000               |
| MU18-10FBK                  | 01201         | 22-18            | 10        | 0.30 | 0.25 | 0.65 | 0.50 | 0.030     | 0.25          | 0.070       | 1000               |

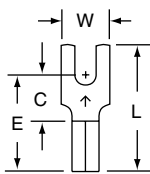

MU18-4FB/S  
4  
22-18

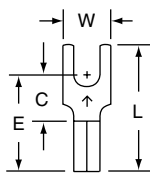

MU18-6FB/S  
6  
22-18

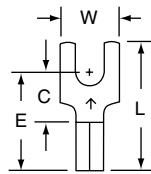

MU18-6FB  
6  
22-18

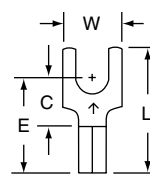

MU18-8FB  
8  
22-18

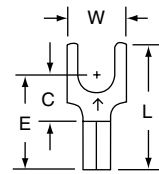

MU18-10FB  
10  
22-18

Stud Size  
Wire Range

<sup>1</sup>Product number ending in X = box; product number ending with K = bulk.



# 3M™ Block Forks — Non-Insulated Butted Seam 16-14 AWG



| Product Number* | UPC (054007-) | Wire Range (AWG) | Stud Size | W    | C    | L    | E    | Thickness | Barrel Length | Barrel I.D. | Terminals per Case |
|-----------------|---------------|------------------|-----------|------|------|------|------|-----------|---------------|-------------|--------------------|
| MU14-4FB/SK     | 02264         | 16-14            | 4         | 0.25 | 0.25 | 0.65 | 0.50 | 0.030     | 0.25          | 0.090       | 1000               |
| MU14-6FB/SK     | 01564         | 16-14            | 6         | 0.25 | 0.25 | 0.65 | 0.50 | 0.030     | 0.25          | 0.090       | 1000               |
| MU14-6FBK       | 01565         | 16-14            | 6         | 0.30 | 0.25 | 0.65 | 0.50 | 0.030     | 0.25          | 0.090       | 1000               |
| MU14-8FBK       | 01566         | 16-14            | 8         | 0.30 | 0.25 | 0.65 | 0.50 | 0.030     | 0.25          | 0.090       | 1000               |
| MU14-10FBK      | 01567         | 16-14            | 10        | 0.30 | 0.25 | 0.65 | 0.50 | 0.030     | 0.25          | 0.090       | 1000               |

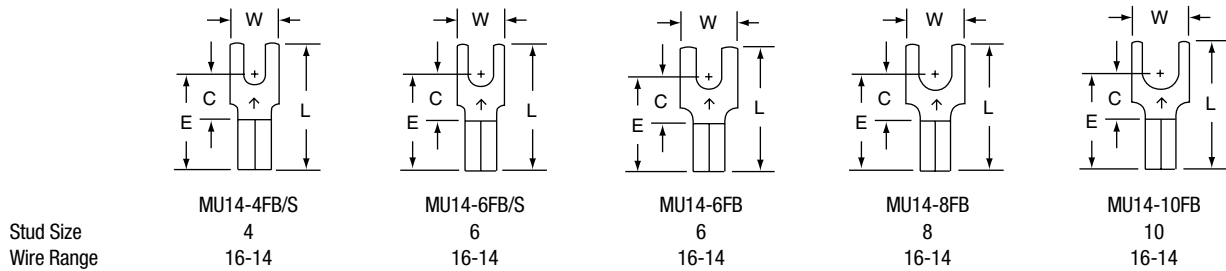

\*Product number ending in X = box; product number ending with K = bulk.

## 3M™ Block Forks — Non-Insulated Butted Seam 12-10 AWG



| Product Number <sup>a</sup> | UPC (054007-) | Wire Range (AWG) | Stud Size | W    | C    | L    | E    | Thickness | Barrel Length | Barrel I.D. | Terminals per Case |
|-----------------------------|---------------|------------------|-----------|------|------|------|------|-----------|---------------|-------------|--------------------|
| MU10-6FBK                   | 02005         | 12-10            | 6         | 0.32 | 0.29 | 0.73 | 0.54 | 0.040     | 0.25          | 0.135       | 500                |
| MU10-8FBK                   | 02006         | 12-10            | 8         | 0.32 | 0.29 | 0.73 | 0.54 | 0.040     | 0.25          | 0.135       | 500                |
| MU10-10FBK                  | 02007         | 12-10            | 10        | 0.32 | 0.29 | 0.73 | 0.54 | 0.040     | 0.25          | 0.135       | 500                |

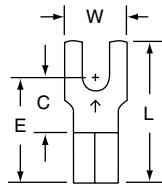

MU10-6FB

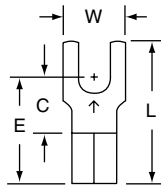

MU10-8FB

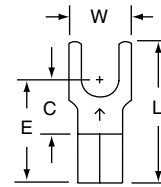

MU10-10FB

Stud Size

6

8

10

Wire Range

12-10

12-10

12-10

## 3M™ Block Forks — Vinyl Insulated Brazed Seam 22-18 AWG



| Product Number <sup>a</sup> | UPC (054007-) | Wire Range (AWG) | Stud Size | W    | C    | L    | E    | Thickness | Barrel Length | Barrel I.D. | Maximum Insulation Diameter | Terminals per Carton | Case |
|-----------------------------|---------------|------------------|-----------|------|------|------|------|-----------|---------------|-------------|-----------------------------|----------------------|------|
| MV18-4FB/SK                 | 02279         | 22-18            | 4         | 0.25 | 0.25 | 0.85 | 0.70 | 0.030     | 0.25          | 0.070       | 0.145                       | —                    | 1000 |
| MV18-6FB/SX                 | 49602         | 22-18            | 6         | 0.25 | 0.25 | 0.85 | 0.70 | 0.030     | 0.25          | 0.070       | 0.145                       | 100                  | 500  |
| MV18-6FB/SK                 | 01210         | 22-18            | 6         | 0.25 | 0.25 | 0.85 | 0.70 | 0.030     | 0.25          | 0.070       | 0.145                       | —                    | 1000 |
| MV18-6FBX                   | 21973         | 22-18            | 6         | 0.30 | 0.25 | 0.85 | 0.70 | 0.030     | 0.25          | 0.070       | 0.145                       | 100                  | 500  |
| MV18-6FBK                   | 01211         | 22-18            | 6         | 0.30 | 0.25 | 0.85 | 0.70 | 0.030     | 0.25          | 0.070       | 0.145                       | —                    | 1000 |
| MV18-8FBX                   | 21999         | 22-18            | 8         | 0.30 | 0.25 | 0.85 | 0.70 | 0.030     | 0.25          | 0.070       | 0.145                       | 100                  | 500  |
| MV18-8FBK                   | 01212         | 22-18            | 8         | 0.30 | 0.25 | 0.85 | 0.70 | 0.030     | 0.25          | 0.070       | 0.145                       | —                    | 1000 |
| MV18-10FBX                  | 22005         | 22-18            | 10        | 0.30 | 0.25 | 0.85 | 0.70 | 0.030     | 0.25          | 0.070       | 0.145                       | 100                  | 500  |
| MV18-10FBK                  | 01213         | 22-18            | 10        | 0.30 | 0.25 | 0.85 | 0.70 | 0.030     | 0.25          | 0.070       | 0.145                       | —                    | 1000 |

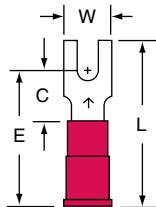

MV18-4FB/S

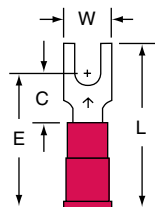

MV18-6FB/S

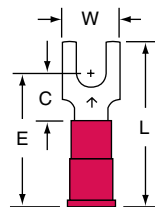

MV18-6FB

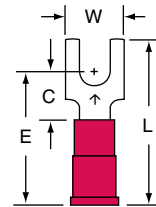

MV18-8FB

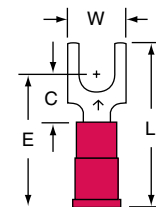

MV18-10FB

Stud Size

4

6

6

8

10

Wire Range

22-18

22-18

22-18

22-18

22-18

<sup>a</sup>Product number ending in X = box; product number ending with K = bulk.

### 3M™ Block Forks — Vinyl Insulated Brazed Seam 16-14 AWG



| Product Number* | UPC (054007-) | Wire Range (AWG) | Stud Size | W    | C    | L    | E    | Thickness | Barrel Length | Barrel I.D. | Maximum Insulation Diameter | Terminals per Carton | Case |
|-----------------|---------------|------------------|-----------|------|------|------|------|-----------|---------------|-------------|-----------------------------|----------------------|------|
| MV14-4FB/SK     | 02280         | 16-14            | 4         | 0.25 | 0.25 | 0.85 | 0.70 | 0.030     | 0.25          | 0.090       | 0.170                       | —                    | 1000 |
| MV14-6FB/SX     | 49624         | 16-14            | 6         | 0.25 | 0.25 | 0.85 | 0.70 | 0.030     | 0.25          | 0.090       | 0.170                       | 100                  | 500  |
| MV14-6FB/SK     | 01576         | 16-14            | 6         | 0.25 | 0.25 | 0.85 | 0.70 | 0.030     | 0.25          | 0.090       | 0.170                       | —                    | 1000 |
| MV14-6FBX       | 22641         | 16-14            | 6         | 0.30 | 0.25 | 0.85 | 0.70 | 0.030     | 0.25          | 0.090       | 0.170                       | 100                  | 500  |
| MV14-6FBK       | 01577         | 16-14            | 6         | 0.30 | 0.25 | 0.85 | 0.70 | 0.030     | 0.25          | 0.090       | 0.170                       | —                    | 1000 |
| MV14-8FBX       | 22658         | 16-14            | 8         | 0.30 | 0.25 | 0.85 | 0.70 | 0.030     | 0.25          | 0.090       | 0.170                       | 100                  | 500  |
| MV14-8FBK       | 01578         | 16-14            | 8         | 0.30 | 0.25 | 0.85 | 0.70 | 0.030     | 0.25          | 0.090       | 0.170                       | —                    | 1000 |
| MV14-10FBX      | 22666         | 16-14            | 10        | 0.30 | 0.25 | 0.85 | 0.70 | 0.030     | 0.25          | 0.090       | 0.170                       | 100                  | 500  |
| MV14-10FBK      | 01579         | 16-14            | 10        | 0.30 | 0.25 | 0.85 | 0.70 | 0.030     | 0.25          | 0.090       | 0.170                       | —                    | 1000 |

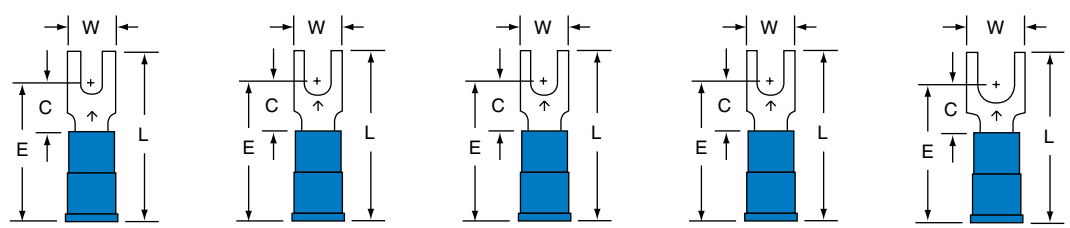

|            | MV14-4FB/S | MV14-6FB/S | MV14-6FB | MV14-8FB | MV14-10FB |
|------------|------------|------------|----------|----------|-----------|
| Stud Size  | 4          | 6          | 6        | 8        | 10        |
| Wire Range | 16-14      | 16-14      | 16-14    | 16-14    | 16-14     |

### 3M™ Block Forks — Vinyl Insulated Brazed Seam 12-10 AWG



| Product Number* | UPC (054007-) | Wire Range (AWG) | Stud Size | W    | C    | L    | E    | Thickness | Barrel Length | Barrel I.D. | Maximum Insulation Diameter | Terminals per Carton | Case |
|-----------------|---------------|------------------|-----------|------|------|------|------|-----------|---------------|-------------|-----------------------------|----------------------|------|
| MV10-6FBX       | 23698         | 12-10            | 6         | 0.32 | 0.29 | 1.03 | 0.84 | 0.040     | 0.25          | 0.135       | 0.250                       | 50                   | 500  |
| MV10-6FBK       | 02014         | 12-10            | 6         | 0.32 | 0.29 | 1.03 | 0.84 | 0.040     | 0.25          | 0.135       | 0.250                       | —                    | 500  |
| MV10-8FBX       | 23706         | 12-10            | 8         | 0.32 | 0.29 | 1.03 | 0.84 | 0.040     | 0.25          | 0.135       | 0.250                       | 50                   | 500  |
| MV10-8FBK       | 02015         | 12-10            | 8         | 0.32 | 0.29 | 1.03 | 0.84 | 0.040     | 0.25          | 0.135       | 0.250                       | —                    | 500  |
| MV10-10FBX      | 23714         | 12-10            | 10        | 0.32 | 0.29 | 1.03 | 0.84 | 0.040     | 0.25          | 0.135       | 0.250                       | 50                   | 500  |
| MV10-10FBK      | 02016         | 12-10            | 10        | 0.32 | 0.29 | 1.03 | 0.84 | 0.040     | 0.25          | 0.135       | 0.250                       | —                    | 500  |

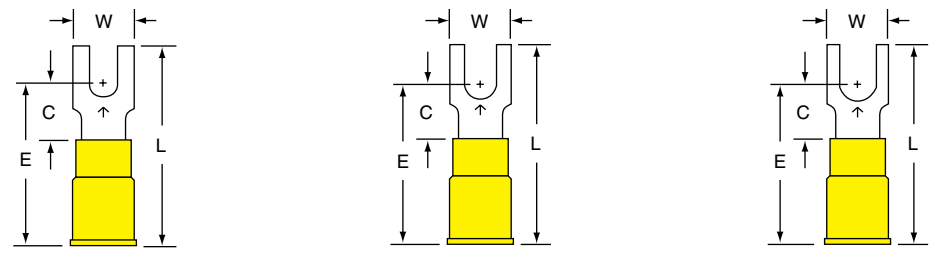

|            | MV10-6FB | MV10-8FB | MV10-10FB |
|------------|----------|----------|-----------|
| Stud Size  | 6        | 8        | 10        |
| Wire Range | 12-10    | 12-10    | 12-10     |

\*Product number ending in X = box; product number ending with K = bulk.

## 3M™ Block Forks — Vinyl Insulated Butted Seam 22-18 AWG



| Product Number <sup>1</sup> | UPC (054007-) | Wire Range (AWG) | Stud Size | W    | C    | L    | E    | Thickness | Barrel Length | Barrel I.D. | Maximum Insulation Diameter | Terminals per Case |
|-----------------------------|---------------|------------------|-----------|------|------|------|------|-----------|---------------|-------------|-----------------------------|--------------------|
| MVU18-4FB/SK                | 02253         | 22-18            | 4         | 0.25 | 0.25 | 0.85 | 0.70 | 0.030     | 0.25          | 0.070       | 0.145                       | 1000               |
| MVU18-6FB/SK                | 01218         | 22-18            | 6         | 0.25 | 0.25 | 0.85 | 0.70 | 0.030     | 0.25          | 0.070       | 0.145                       | 1000               |
| MVU18-6FBK                  | 01219         | 22-18            | 6         | 0.30 | 0.25 | 0.85 | 0.70 | 0.030     | 0.25          | 0.070       | 0.145                       | 1000               |
| MVU18-8FBK                  | 01220         | 22-18            | 8         | 0.30 | 0.25 | 0.85 | 0.70 | 0.030     | 0.25          | 0.070       | 0.145                       | 1000               |
| MVU18-10FBK                 | 01221         | 22-18            | 10        | 0.30 | 0.25 | 0.85 | 0.70 | 0.030     | 0.25          | 0.070       | 0.145                       | 1000               |

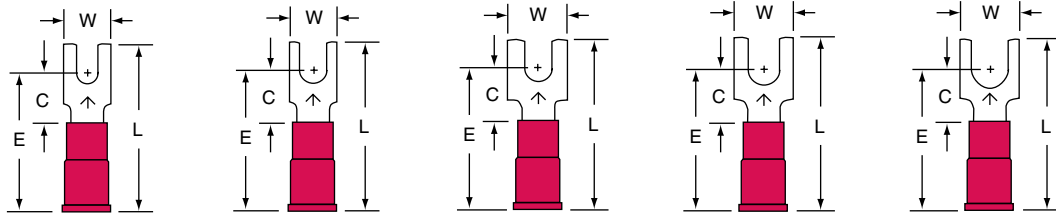

MVU18-4FB/S

MVU18-6FB/S

MVU18-6FB

MVU18-8FB

MVU18-10FB

Stud Size

4

6

6

8

10

Wire Range

22-18

22-18

22-18

22-18

22-18

## 3M™ Block Forks — Vinyl Insulated Butted Seam 16-14 AWG



| Product Number <sup>1</sup> | UPC (054007-) | Wire Range (AWG) | Stud Size | W    | C    | L    | E    | Thickness | Barrel Length | Barrel I.D. | Maximum Insulation Diameter | Terminals per Case |
|-----------------------------|---------------|------------------|-----------|------|------|------|------|-----------|---------------|-------------|-----------------------------|--------------------|
| MVU14-4FB/SK                | 02258         | 16-14            | 4         | 0.25 | 0.25 | 0.85 | 0.70 | 0.030     | 0.25          | 0.090       | 0.170                       | 1000               |
| MVU14-6FB/SK                | 01584         | 16-14            | 6         | 0.25 | 0.25 | 0.85 | 0.70 | 0.030     | 0.25          | 0.090       | 0.170                       | 1000               |
| MVU14-6FBK                  | 01585         | 16-14            | 6         | 0.30 | 0.25 | 0.85 | 0.70 | 0.030     | 0.25          | 0.090       | 0.170                       | 1000               |
| MVU14-8FBK                  | 01586         | 16-14            | 8         | 0.30 | 0.25 | 0.85 | 0.70 | 0.030     | 0.25          | 0.090       | 0.170                       | 1000               |
| MVU14-10FBK                 | 01587         | 16-14            | 10        | 0.30 | 0.25 | 0.85 | 0.70 | 0.030     | 0.25          | 0.090       | 0.170                       | 1000               |

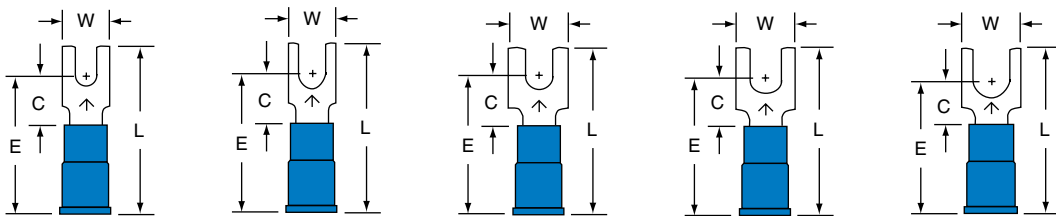

MVU14-4FB/S

MVU14-6FB/S

MVU14-6FB

MVU14-8FB

MVU14-10FB

Stud Size

4

6

6

8

10

Wire Range

16-14

16-14

16-14

16-14

16-14

<sup>1</sup>Product number ending in X = box; product number ending with K = bulk.



### 3M™ Block Forks — Vinyl Insulated Butted Seam 12-10 AWG



| Product Number* | UPC (054007-) | Wire Range (AWG) | Stud Size | W    | C    | L    | E    | Thickness | Barrel Length | Barrel I.D. | Maximum Insulation Diameter | Terminals per Case |
|-----------------|---------------|------------------|-----------|------|------|------|------|-----------|---------------|-------------|-----------------------------|--------------------|
| MVU10-6FBK      | 02020         | 12-10            | 6         | 0.32 | 0.29 | 1.03 | 0.84 | 0.040     | 0.25          | 0.135       | 0.250                       | 500                |
| MVU10-8FBK      | 02021         | 12-10            | 8         | 0.32 | 0.29 | 1.03 | 0.84 | 0.040     | 0.25          | 0.135       | 0.250                       | 500                |
| MVU10-10FBK     | 02022         | 12-10            | 10        | 0.32 | 0.29 | 1.03 | 0.84 | 0.040     | 0.25          | 0.135       | 0.250                       | 500                |

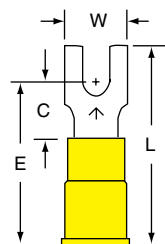

MVU10-6FB

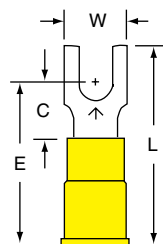

MVU10-8FB

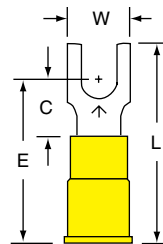

MVU10-10FB

Stud Size

6

8

10

Wire Range

12-10

12-10

12-10

### 3M™ Block Forks — Nylon Insulated with Insulation Grip 22-18 AWG



| Product Number* | UPC (054007-) | Wire Range (AWG) | Stud Size | W    | C    | L    | E    | Thickness | Barrel Length | Barrel I.D. | Maximum Insulation Diameter | Terminals per Carton | Case |
|-----------------|---------------|------------------|-----------|------|------|------|------|-----------|---------------|-------------|-----------------------------|----------------------|------|
| MNG18-4FB/SK    | 02261         | 22-18            | 4         | 0.25 | 0.25 | 0.84 | 0.69 | 0.030     | 0.25          | 0.070       | 0.145                       | —                    | 1000 |
| MNG18-6FB/SX    | 49603         | 22-18            | 6         | 0.25 | 0.25 | 0.84 | 0.69 | 0.030     | 0.25          | 0.070       | 0.145                       | 100                  | 500  |
| MNG18-6FB/SK    | 01214         | 22-18            | 6         | 0.25 | 0.25 | 0.84 | 0.69 | 0.030     | 0.25          | 0.070       | 0.145                       | —                    | 1000 |
| MNG18-6FBX      | 22013         | 22-18            | 6         | 0.30 | 0.25 | 0.84 | 0.69 | 0.030     | 0.25          | 0.070       | 0.145                       | 100                  | 500  |
| MNG18-6FBK      | 01215         | 22-18            | 6         | 0.30 | 0.25 | 0.84 | 0.69 | 0.030     | 0.25          | 0.070       | 0.145                       | —                    | 1000 |
| MNG18-8FBX      | 22021         | 22-18            | 8         | 0.30 | 0.25 | 0.84 | 0.69 | 0.030     | 0.25          | 0.070       | 0.145                       | 100                  | 500  |
| MNG18-8FBK      | 01216         | 22-18            | 8         | 0.30 | 0.25 | 0.84 | 0.69 | 0.030     | 0.25          | 0.070       | 0.145                       | —                    | 1000 |
| MNG18-10FBX     | 22039         | 22-18            | 10        | 0.30 | 0.25 | 0.84 | 0.69 | 0.030     | 0.25          | 0.070       | 0.145                       | 100                  | 500  |
| MNG18-10FBK     | 01217         | 22-18            | 10        | 0.30 | 0.25 | 0.84 | 0.69 | 0.030     | 0.25          | 0.070       | 0.145                       | —                    | 1000 |

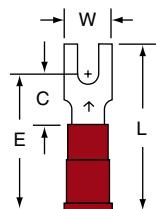

MNG18-4FB/S

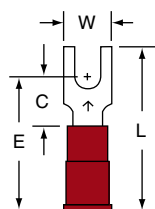

MNG18-6FB/S

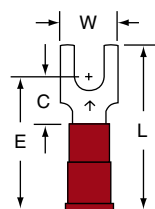

MNG18-6FB

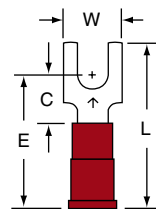

MNG18-8FB

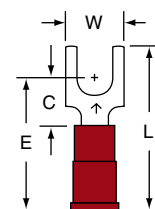

MNG18-10FB

Stud Size

4

6

6

8

10

Wire Range

22-18

22-18

22-18

22-18

22-18

\*Product number ending in X = box; product number ending with K = bulk.

## 3M™ Block Forks — Nylon Insulated with Insulation Grip 16-14 AWG



| Product Number | UPC (054007-) | Wire Range (AWG) | Stud Size | W    | C    | L    | E    | Thickness | Barrel Length | Barrel I.D. | Maximum Insulation Diameter | Terminals per: Carton | Case |
|----------------|---------------|------------------|-----------|------|------|------|------|-----------|---------------|-------------|-----------------------------|-----------------------|------|
| MNG14-4FB/SK   | 02262         | 16-14            | 4         | 0.25 | 0.25 | 0.86 | 0.71 | 0.030     | 0.25          | 0.090       | 0.170                       | —                     | 1000 |
| MNG14-6FB/SX   | 49625         | 16-14            | 6         | 0.25 | 0.25 | 0.86 | 0.71 | 0.030     | 0.25          | 0.090       | 0.170                       | 100                   | 500  |
| MNG14-6FB/SK   | 01580         | 16-14            | 6         | 0.25 | 0.25 | 0.86 | 0.71 | 0.030     | 0.25          | 0.090       | 0.170                       | —                     | 1000 |
| MNG14-6FBX     | 22674         | 16-14            | 6         | 0.30 | 0.25 | 0.86 | 0.71 | 0.030     | 0.25          | 0.090       | 0.170                       | 100                   | 500  |
| MNG14-6FBK     | 01581         | 16-14            | 6         | 0.30 | 0.25 | 0.86 | 0.71 | 0.030     | 0.25          | 0.090       | 0.170                       | —                     | 1000 |
| MNG14-8FBX     | 22682         | 16-14            | 8         | 0.30 | 0.25 | 0.86 | 0.71 | 0.030     | 0.25          | 0.090       | 0.170                       | 100                   | 500  |
| MNG14-8FBK     | 01582         | 16-14            | 8         | 0.30 | 0.25 | 0.86 | 0.71 | 0.030     | 0.25          | 0.090       | 0.170                       | —                     | 1000 |
| MNG14-10FBX    | 22690         | 16-14            | 10        | 0.30 | 0.25 | 0.86 | 0.71 | 0.030     | 0.25          | 0.090       | 0.170                       | 100                   | 500  |
| MNG14-10FBK    | 01583         | 16-14            | 10        | 0.30 | 0.25 | 0.86 | 0.71 | 0.030     | 0.25          | 0.090       | 0.170                       | —                     | 1000 |

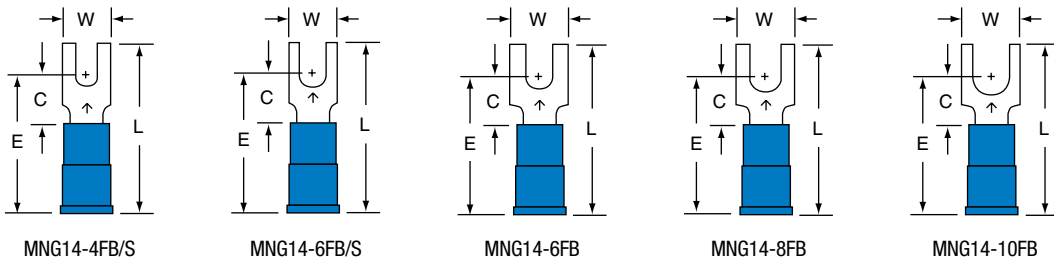

|            |       |       |       |       |       |
|------------|-------|-------|-------|-------|-------|
| Stud Size  | 4     | 6     | 6     | 8     | 10    |
| Wire Range | 16-14 | 16-14 | 16-14 | 16-14 | 16-14 |

## 3M™ Block Forks — Nylon Insulated with Insulation Grip 12-10 AWG



| Product Number | UPC (054007-) | Wire Range (AWG) | Stud Size | W    | C    | L    | E    | Thickness | Barrel Length | Barrel I.D. | Maximum Insulation Diameter | Terminals per: Carton | Case |
|----------------|---------------|------------------|-----------|------|------|------|------|-----------|---------------|-------------|-----------------------------|-----------------------|------|
| MNG10-6FBX     | 23722         | 12-10            | 6         | 0.32 | 0.29 | 1.03 | 0.84 | 0.040     | 0.25          | 0.135       | 0.250                       | 50                    | 500  |
| MNG10-6FBK     | 02017         | 12-10            | 6         | 0.32 | 0.29 | 1.03 | 0.84 | 0.040     | 0.25          | 0.135       | 0.250                       | —                     | 500  |
| MNG10-8FBX     | 23730         | 12-10            | 8         | 0.32 | 0.29 | 1.03 | 0.84 | 0.040     | 0.25          | 0.135       | 0.250                       | 50                    | 500  |
| MNG10-8FBK     | 02018         | 12-10            | 8         | 0.32 | 0.29 | 1.03 | 0.84 | 0.040     | 0.25          | 0.135       | 0.250                       | —                     | 500  |
| MNG10-10FBX    | 23748         | 12-10            | 10        | 0.32 | 0.29 | 1.03 | 0.84 | 0.040     | 0.25          | 0.135       | 0.250                       | 50                    | 500  |
| MNG10-10FBK    | 02019         | 12-10            | 10        | 0.32 | 0.29 | 1.03 | 0.84 | 0.040     | 0.25          | 0.135       | 0.250                       | —                     | 500  |

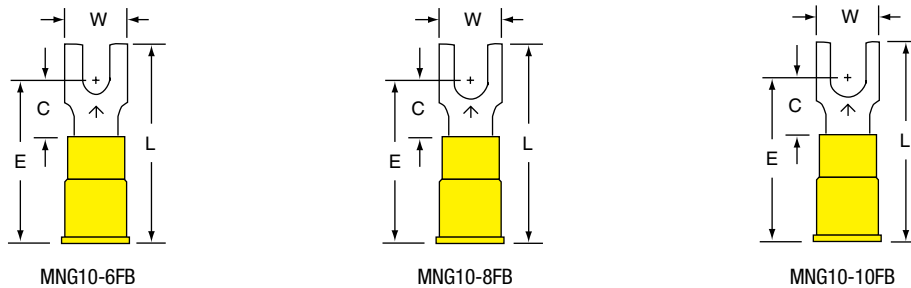

|            |       |       |       |
|------------|-------|-------|-------|
| Stud Size  | 6     | 8     | 10    |
| Wire Range | 12-10 | 12-10 | 12-10 |

Product number ending in X = box; product number ending with K = bulk.

# Flanged Block Forks

## 3M™ Flanged Block Forks — Non-Insulated Brazed Seam



| Product Number* | UPC (054007-) | Wire Range (AWG) | Stud Size | W    | C    | L    | E    | Thickness | Barrel Length | Barrel I.D. | Terminals per Case |
|-----------------|---------------|------------------|-----------|------|------|------|------|-----------|---------------|-------------|--------------------|
| M14-6FFBK       | 01617         | 16-14            | 6         | 0.30 | 0.25 | 0.65 | 0.50 | 0.030     | 0.25          | 0.090       | 1000               |
| M14-8FFBK       | 01618         | 16-14            | 8         | 0.30 | 0.25 | 0.65 | 0.50 | 0.030     | 0.25          | 0.090       | 1000               |
| M14-10FFBK      | 01619         | 16-14            | 10        | 0.30 | 0.25 | 0.65 | 0.50 | 0.030     | 0.25          | 0.090       | 1000               |
| M10-8FFBK       | 02027         | 12-10            | 8         | 0.32 | 0.29 | 0.73 | 0.54 | 0.040     | 0.25          | 0.135       | 500                |
| M10-10FFBK      | 02028         | 12-10            | 10        | 0.32 | 0.29 | 0.73 | 0.54 | 0.040     | 0.25          | 0.135       | 500                |

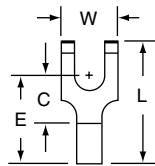

M18-6FFB

Stud Size

6

Wire Range

22-18

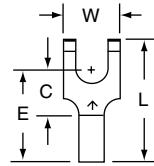

M18-8FFB

8

22-18

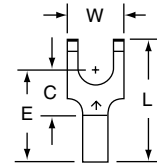

M18-10FFB

10

22-18

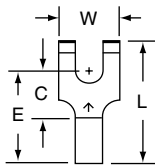

M14-6FFB

Stud Size

6

Wire Range

16-14

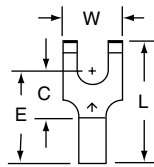

M14-8FFB

8

16-14

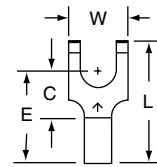

M14-10FFB

10

16-14

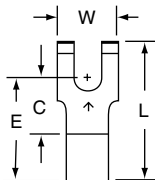

M10-6FFB

Stud Size

6

Wire Range

12-10

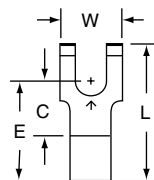

M10-8FFB

8

12-10

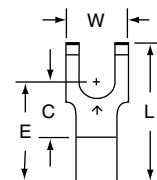

M10-10FFB

10

12-10

\*Product number ending in X = box; product number ending with K = bulk.

# 3M™ Flanged Block Forks — Non-Insulated Butted Seam



| Product Number <sup>1</sup> | UPC (054007-) | Wire Range (AWG) | Stud Size | W    | C    | L    | E    | Thickness | Barrel Length | Barrel I.D. | Terminals per Case |
|-----------------------------|---------------|------------------|-----------|------|------|------|------|-----------|---------------|-------------|--------------------|
| MU18-6FFBK                  | 01247         | 22-18            | 6         | 0.30 | 0.25 | 0.65 | 0.50 | 0.030     | 0.25          | 0.070       | 1000               |
| MU14-6FFBK                  | 01613         | 16-14            | 6         | 0.30 | 0.25 | 0.65 | 0.50 | 0.030     | 0.25          | 0.090       | 1000               |
| MU14-8FFBK                  | 01614         | 16-14            | 8         | 0.30 | 0.25 | 0.65 | 0.50 | 0.030     | 0.25          | 0.090       | 1000               |
| MU14-10FFBK                 | 01615         | 16-14            | 10        | 0.30 | 0.25 | 0.65 | 0.50 | 0.030     | 0.25          | 0.090       | 1000               |
| MU10-6FFBK                  | 02023         | 12-10            | 6         | 0.32 | 0.29 | 0.73 | 0.54 | 0.040     | 0.25          | 0.135       | 500                |
| MU10-8FFBK                  | 02024         | 12-10            | 8         | 0.32 | 0.29 | 0.73 | 0.54 | 0.040     | 0.25          | 0.135       | 500                |
| MU10-10FFBK                 | 02025         | 12-10            | 10        | 0.32 | 0.29 | 0.73 | 0.54 | 0.040     | 0.25          | 0.135       | 500                |

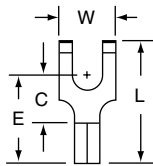

MU18-6FFB

Stud Size

6

Wire Range

22-18

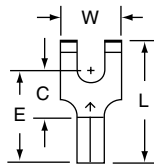

MU14-6FFB

6

16-14

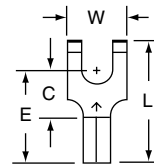

MU14-8FFB

8

16-14

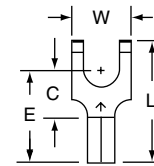

MU14-10FFB

10

16-14

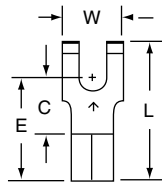

MU10-6FFB

Stud Size

6

Wire Range

12-10

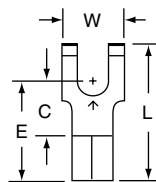

MU10-8FFB

8

12-10

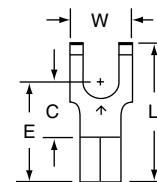

MU10-10FFB

10

12-10

<sup>1</sup>Product number ending in X = box; product number ending with K = bulk.



# 3M™ Flanged Block Forks — Vinyl Insulated Brazed Seam



| Product Number* | UPC (054007-) | Wire Range (AWG) | Stud Size | W    | C    | L    | E    | Thickness | Barrel Length | Barrel I.D. | Maximum Insulation Diameter | Terminals per Case |
|-----------------|---------------|------------------|-----------|------|------|------|------|-----------|---------------|-------------|-----------------------------|--------------------|
| MV18-8FFBK      | 01260         | 22-18            | 8         | 0.30 | 0.25 | 0.85 | 0.70 | 0.030     | 0.25          | 0.070       | 0.145                       | 1000               |
| MV18-10FFBK     | 01261         | 22-18            | 10        | 0.30 | 0.25 | 0.85 | 0.70 | 0.030     | 0.25          | 0.070       | 0.145                       | 1000               |
| MV14-6FFBK      | 01625         | 16-14            | 6         | 0.30 | 0.25 | 0.85 | 0.70 | 0.030     | 0.25          | 0.090       | 0.170                       | 1000               |
| MV14-8FFBK      | 01626         | 16-14            | 8         | 0.30 | 0.25 | 0.85 | 0.70 | 0.030     | 0.25          | 0.090       | 0.170                       | 1000               |
| MV14-10FFBK     | 01627         | 16-14            | 10        | 0.30 | 0.25 | 0.85 | 0.70 | 0.030     | 0.25          | 0.090       | 0.170                       | 1000               |
| MV10-8FFBK      | 02033         | 12-10            | 8         | 0.32 | 0.29 | 1.03 | 0.84 | 0.040     | 0.25          | 0.135       | 0.250                       | 500                |
| MV10-10FFBK     | 02034         | 12-10            | 10        | 0.32 | 0.29 | 1.03 | 0.84 | 0.040     | 0.25          | 0.135       | 0.250                       | 500                |

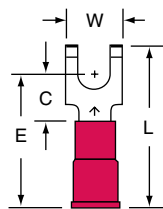

MV18-8FFBK

Stud Size

8

Wire Range

22-18

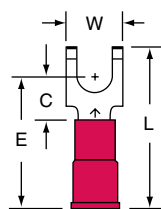

MV18-10FFBK

10

22-18

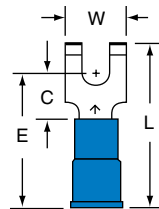

MV14-6FFBK

6

16-14

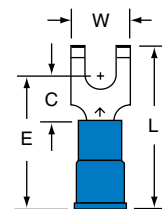

MV14-8FFBK

8

16-14

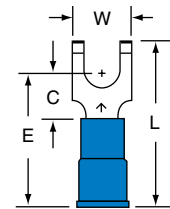

MV14-10FFBK

10

16-14

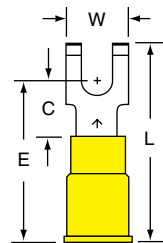

MV10-8FFBK

Stud Size

8

Wire Range

12-10

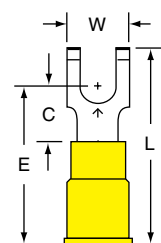

MV10-10FFBK

10

12-10

\*Product number ending in X = box; product number ending with K = bulk.

# 3M™ Flanged Block Forks — Vinyl Insulated Butted Seam



| Product Number* | UPC (054007-) | Wire Range (AWG) | Stud Size | W    | C    | L    | E    | Thickness | Barrel Length | Barrel I.D. | Maximum Insulation Diameter | Terminals per Case |
|-----------------|---------------|------------------|-----------|------|------|------|------|-----------|---------------|-------------|-----------------------------|--------------------|
| MVU18-6FFBK     | 01267         | 22-18            | 6         | 0.30 | 0.25 | 0.85 | 0.70 | 0.030     | 0.25          | 0.070       | 0.145                       | 1000               |
| MVU18-8FFBK     | 01268         | 22-18            | 8         | 0.30 | 0.25 | 0.85 | 0.70 | 0.030     | 0.25          | 0.070       | 0.145                       | 1000               |
| MVU18-10FFBK    | 01269         | 22-18            | 10        | 0.30 | 0.25 | 0.85 | 0.70 | 0.030     | 0.25          | 0.070       | 0.145                       | 1000               |
| MVU14-6FFBK     | 01633         | 16-14            | 6         | 0.30 | 0.25 | 0.85 | 0.70 | 0.030     | 0.25          | 0.090       | 0.170                       | 1000               |
| MVU14-8FFBK     | 01634         | 16-14            | 8         | 0.30 | 0.25 | 0.85 | 0.70 | 0.030     | 0.25          | 0.090       | 0.170                       | 1000               |
| MVU14-10FFBK    | 01635         | 16-14            | 10        | 0.30 | 0.25 | 0.85 | 0.70 | 0.030     | 0.25          | 0.090       | 0.170                       | 1000               |
| MVU10-6FFBK     | 02038         | 12-10            | 6         | 0.32 | 0.29 | 1.03 | 0.84 | 0.040     | 0.25          | 0.135       | 0.250                       | 500                |
| MVU10-8FFBK     | 02039         | 12-10            | 8         | 0.32 | 0.29 | 1.03 | 0.84 | 0.040     | 0.25          | 0.135       | 0.250                       | 500                |
| MVU10-10FFBK    | 02040         | 12-10            | 10        | 0.32 | 0.29 | 1.03 | 0.84 | 0.040     | 0.25          | 0.135       | 0.250                       | 500                |

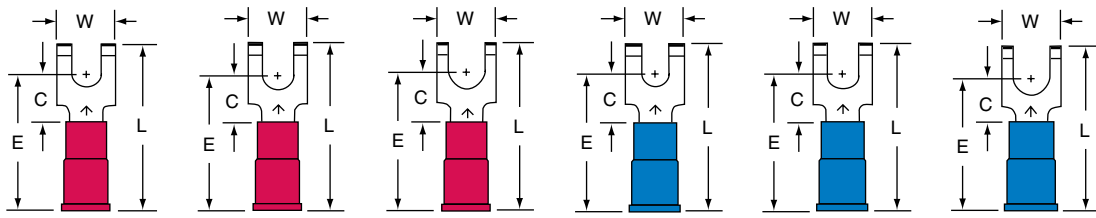

|            | MVU18-6FFBK | MVU18-8FFBK | MVU18-10FFBK | MVU14-6FFBK | MVU14-8FFBK | MVU14-10FFBK |
|------------|-------------|-------------|--------------|-------------|-------------|--------------|
| Stud Size  | 6           | 8           | 10           | 6           | 8           | 10           |
| Wire Range | 22-18       | 22-18       | 22-18        | 16-14       | 16-14       | 16-14        |

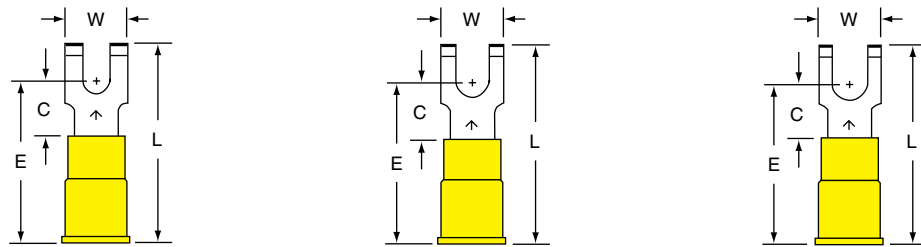

|            | MVU10-6FFBK | MVU10-8FFBK | MVU10-10FFBK |
|------------|-------------|-------------|--------------|
| Stud Size  | 6           | 8           | 10           |
| Wire Range | 12-10       | 12-10       | 12-10        |

\*Product number ending in X = box; product number ending with K = bulk.

# 3M™ Flanged Block Forks — Nylon Insulated with Insulation Grip



TERMINALS, KITS AND TOOLS • Flanged Block Forks

| Product Number* | UPC (054007-) | Wire Range (AWG) | Stud Size | W    | C    | L    | E    | Thickness | Barrel Length | Barrel I.D. | Maximum Insulation Diameter | Terminals per Carton | Case |
|-----------------|---------------|------------------|-----------|------|------|------|------|-----------|---------------|-------------|-----------------------------|----------------------|------|
| MNG18-6FFB/SX   | 49604         | 22-18            | 6         | 0.25 | 0.25 | 0.84 | 0.69 | 0.030     | 0.25          | 0.070       | 0.145                       | 100                  | 500  |
| MNG18-6FFBK     | 01263         | 22-18            | 6         | 0.30 | 0.25 | 0.84 | 0.69 | 0.030     | 0.25          | 0.070       | 0.145                       | —                    | 1000 |
| MNG18-8FFBX     | 49605         | 22-18            | 8         | 0.30 | 0.25 | 0.84 | 0.69 | 0.030     | 0.25          | 0.070       | 0.145                       | 100                  | 500  |
| MNG18-8FFBK     | 01264         | 22-18            | 8         | 0.30 | 0.25 | 0.84 | 0.69 | 0.030     | 0.25          | 0.070       | 0.145                       | —                    | 1000 |
| MNG18-10FFBX    | 49606         | 22-18            | 10        | 0.30 | 0.25 | 0.84 | 0.69 | 0.030     | 0.25          | 0.070       | 0.145                       | 100                  | 500  |
| MNG18-10FFBK    | 01265         | 22-18            | 10        | 0.30 | 0.25 | 0.84 | 0.69 | 0.030     | 0.25          | 0.070       | 0.145                       | —                    | 1000 |
| MNG14-6FFB/SX   | 49626         | 16-14            | 6         | 0.25 | 0.25 | 0.86 | 0.71 | 0.030     | 0.25          | 0.090       | 0.170                       | 100                  | 500  |
| MNG14-6FFBK     | 01629         | 16-14            | 6         | 0.30 | 0.25 | 0.86 | 0.71 | 0.030     | 0.25          | 0.090       | 0.170                       | —                    | 1000 |
| MNG14-8FFBX     | 49627         | 16-14            | 8         | 0.30 | 0.25 | 0.86 | 0.71 | 0.030     | 0.25          | 0.090       | 0.170                       | 100                  | 500  |
| MNG14-8FFBK     | 01630         | 16-14            | 8         | 0.30 | 0.25 | 0.86 | 0.71 | 0.030     | 0.25          | 0.090       | 0.170                       | —                    | 1000 |
| MNG14-10FFBX    | 49628         | 16-14            | 10        | 0.30 | 0.25 | 0.86 | 0.71 | 0.030     | 0.25          | 0.090       | 0.170                       | 100                  | 500  |
| MNG14-10FFBK    | 01631         | 16-14            | 10        | 0.30 | 0.25 | 0.86 | 0.71 | 0.030     | 0.25          | 0.090       | 0.170                       | —                    | 1000 |
| MNG10-6FFBX     | 49642         | 12-10            | 6         | 0.32 | 0.29 | 1.03 | 0.84 | 0.040     | 0.25          | 0.135       | 0.250                       | 50                   | 500  |
| MNG10-6FFBK     | 02035         | 12-10            | 6         | 0.32 | 0.29 | 1.03 | 0.84 | 0.040     | 0.25          | 0.135       | 0.250                       | —                    | 500  |
| MNG10-8FFBX     | 49643         | 12-10            | 8         | 0.32 | 0.29 | 1.03 | 0.84 | 0.040     | 0.25          | 0.135       | 0.250                       | 50                   | 500  |
| MNG10-8FFBK     | 02036         | 12-10            | 8         | 0.32 | 0.29 | 1.03 | 0.84 | 0.040     | 0.25          | 0.135       | 0.250                       | —                    | 500  |
| MNG10-10FFBX    | 49644         | 12-10            | 10        | 0.32 | 0.29 | 1.03 | 0.84 | 0.040     | 0.25          | 0.135       | 0.250                       | 50                   | 500  |
| MNG10-10FFBK    | 02037         | 12-10            | 10        | 0.32 | 0.29 | 1.03 | 0.84 | 0.040     | 0.25          | 0.135       | 0.250                       | —                    | 500  |

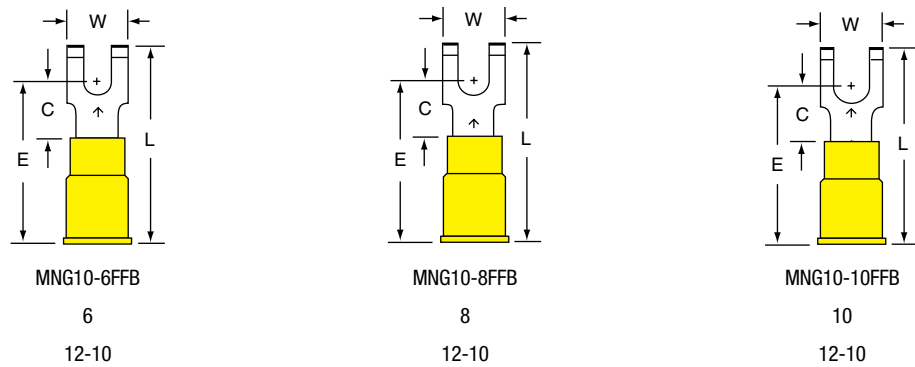
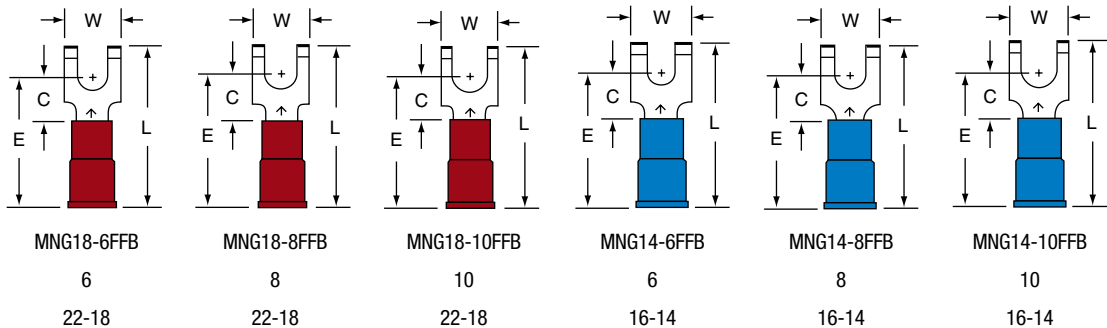

\*Product number ending in X = box; product number ending with K = bulk.

# Locking Forks

## 3M™ Locking Forks — Non-Insulated Brazed Seam 22-18 AWG



| Product Number <sup>1</sup> | UPC (054007-) | Wire Range (AWG) | Stud Size | W    | C    | L    | E    | Thickness | Barrel Length | Barrel I.D. | Maximum Insulation Diameter | Terminals per: Carton | Case |
|-----------------------------|---------------|------------------|-----------|------|------|------|------|-----------|---------------|-------------|-----------------------------|-----------------------|------|
| M18-4FLK                    | 13725         | 22-18            | 4         | 0.27 | 0.25 | 0.25 | 0.68 | 0.50      | 0.030         | 0.25        | 0.070                       | —                     | 1000 |
| M18-6FLX                    | 13732         | 22-18            | 6         | 0.27 | 0.25 | 0.25 | 0.68 | 0.50      | 0.030         | 0.25        | 0.070                       | 100                   | 500  |
| M18-6FLK                    | 13733         | 22-18            | 6         | 0.27 | 0.25 | 0.25 | 0.68 | 0.50      | 0.030         | 0.25        | 0.070                       | —                     | 1000 |
| M18-8FLX                    | 13750         | 22-18            | 8         | 0.34 | 0.30 | 0.25 | 0.68 | 0.50      | 0.030         | 0.25        | 0.070                       | 100                   | 500  |
| M18-10FLX                   | 13757         | 22-18            | 10        | 0.35 | 0.32 | 0.25 | 0.68 | 0.50      | 0.030         | 0.25        | 0.070                       | 100                   | 500  |
| M18-10FLK                   | 13758         | 22-18            | 10        | 0.35 | 0.32 | 0.25 | 0.68 | 0.50      | 0.030         | 0.25        | 0.070                       | —                     | 1000 |

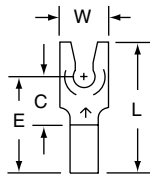

M18-4FL

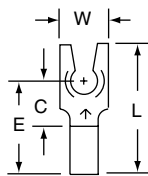

M18-6FL

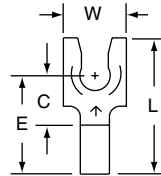

M18-8FL

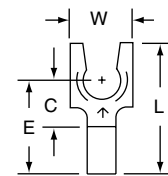

M18-10FL

Stud Size

4

6

8

10

Wire Range

22-18

22-18

22-18

22-18

## 3M™ Locking Forks — Non-Insulated Brazed Seam 16-14 ATG



| Product Number <sup>1</sup> | UPC (054007-) | Wire Range (AWG) | Stud Size | W    | C    | L    | E    | Thickness | Barrel Length | Barrel I.D. | Terminals per: Carton | Case |
|-----------------------------|---------------|------------------|-----------|------|------|------|------|-----------|---------------|-------------|-----------------------|------|
| M14-6FLX                    | 13773         | 16-14            | 6         | 0.27 | 0.25 | 0.68 | 0.50 | 0.030     | 0.25          | 0.090       | 100                   | 500  |
| M14-6FLK                    | 13775         | 16-14            | 6         | 0.27 | 0.25 | 0.68 | 0.50 | 0.030     | 0.25          | 0.090       | —                     | 1000 |
| M14-8FLX                    | 13781         | 16-14            | 8         | 0.34 | 0.30 | 0.68 | 0.50 | 0.030     | 0.25          | 0.090       | 100                   | 500  |
| M14-8FLK                    | 13782         | 16-14            | 8         | 0.34 | 0.30 | 0.68 | 0.50 | 0.030     | 0.25          | 0.090       | —                     | 1000 |
| M14-10FLX                   | 13799         | 16-14            | 10        | 0.35 | 0.32 | 0.68 | 0.50 | 0.030     | 0.25          | 0.090       | 100                   | 500  |
| M14-10FLK                   | 13800         | 16-14            | 10        | 0.35 | 0.32 | 0.68 | 0.50 | 0.030     | 0.25          | 0.090       | —                     | 1000 |
| M14-14FLX                   | 13807         | 16-14            | 1/4       | 0.48 | 0.43 | 0.90 | 0.65 | 0.030     | 0.25          | 0.090       | 100                   | 500  |

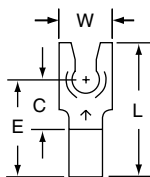

M14-6FL

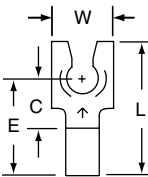

M14-8FL

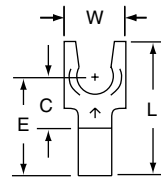

M14-10FL

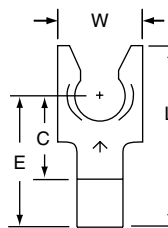

M14-14FL

Stud Size

6

8

10

1/4

Wire Range

16-14

16-14

16-14

16-14

<sup>1</sup>Product number ending in X = box; product number ending with K = bulk.

### 3M™ Locking Forks — Non-Insulated Brazed Seam 12-10 AWG



| Product Number <sup>1</sup> | UPC (054007-) | Wire Range (AWG) | Stud Size | Max. Lock Width | W    | C    | L    | E    | Thickness | Barrel Length | Barrel I.D. | Terminals per Carton | Case |
|-----------------------------|---------------|------------------|-----------|-----------------|------|------|------|------|-----------|---------------|-------------|----------------------|------|
| M10-6FLX                    | 13815         | 12-10            | 6         | 0.30            | 0.28 | 0.28 | 0.73 | 0.53 | 0.040     | 0.25          | 0.135       | 50                   | 500  |
| M10-6FLK                    | 13817         | 12-10            | 6         | 0.30            | 0.28 | 0.28 | 0.73 | 0.53 | 0.040     | 0.25          | 0.135       | —                    | 500  |
| M10-8FLX                    | 13823         | 12-10            | 8         | 0.35            | 0.32 | 0.28 | 0.73 | 0.53 | 0.040     | 0.25          | 0.135       | 50                   | 500  |
| M10-8FLK                    | 13824         | 12-10            | 8         | 0.35            | 0.32 | 0.28 | 0.73 | 0.53 | 0.040     | 0.25          | 0.135       | —                    | 500  |
| M10-10FLX                   | 13831         | 12-10            | 10        | 0.36            | 0.32 | 0.28 | 0.73 | 0.53 | 0.040     | 0.25          | 0.135       | 50                   | 500  |
| M10-10FLK                   | 13832         | 12-10            | 10        | 0.36            | 0.32 | 0.28 | 0.73 | 0.53 | 0.040     | 0.25          | 0.135       | —                    | 500  |
| M10-14FLX                   | 13849         | 12-10            | 1/4       | 0.48            | 0.43 | 0.44 | 0.94 | 0.69 | 0.040     | 0.25          | 0.135       | 50                   | 500  |
| M10-14FLK                   | 13850         | 12-10            | 1/4       | 0.48            | 0.43 | 0.44 | 0.94 | 0.69 | 0.040     | 0.25          | 0.135       | —                    | 500  |

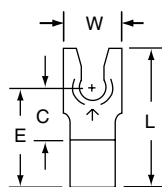

M10-6FL

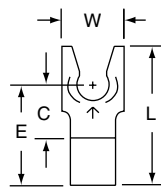

M10-8FL

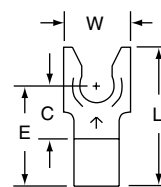

M10-10FL

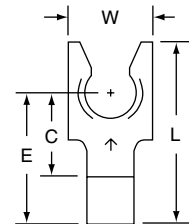

M10-14FL

Stud Size

6

8

10

1/4

Wire Range

12-10

12-10

12-10

12-10

### 3M™ Locking Forks — Non-Insulated Butted Seam 22-18 AWG



| Product Number <sup>1</sup> | UPC (054007-) | Wire Range (AWG) | Stud Size | Max. Lock Width | W    | C    | L    | E    | Thickness | Barrel Length | Barrel I.D. | Terminals per Case |
|-----------------------------|---------------|------------------|-----------|-----------------|------|------|------|------|-----------|---------------|-------------|--------------------|
| MU18-4FLK                   | 01347         | 22-18            | 4         | 0.27            | 0.25 | 0.25 | 0.68 | 0.50 | 0.030     | 0.25          | 0.070       | 1000               |
| MU18-6FLK                   | 01348         | 22-18            | 6         | 0.27            | 0.25 | 0.25 | 0.68 | 0.50 | 0.030     | 0.25          | 0.070       | 1000               |
| MU18-8FLK                   | 01349         | 22-18            | 8         | 0.34            | 0.30 | 0.25 | 0.68 | 0.50 | 0.030     | 0.25          | 0.070       | 1000               |
| MU18-10FLK                  | 01350         | 22-18            | 10        | 0.35            | 0.32 | 0.25 | 0.68 | 0.50 | 0.030     | 0.25          | 0.070       | 1000               |

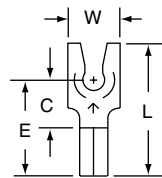

MU18-4FL

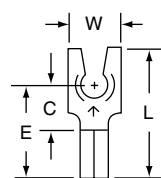

MU18-6FL

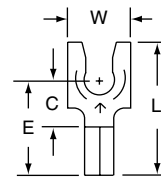

MU18-8FL

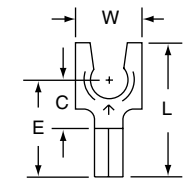

MU18-10FL

Stud Size

4

6

8

10

Wire Range

22-18

22-18

22-18

22-18

<sup>1</sup>Product number ending in X = box; product number ending with K = bulk.

## 3M™ Locking Forks — Non-Insulated Butted Seam 16-14 AWG



| Product Number* | UPC (054007-) | Wire Range (AWG) | Stud Size | Max. Lock Width | W    | C    | L    | E    | Thickness | Barrel Length | Barrel I.D. | Terminals per Case |
|-----------------|---------------|------------------|-----------|-----------------|------|------|------|------|-----------|---------------|-------------|--------------------|
| MU14-4FLK       | 01856         | 16-14            | 4         | 0.27            | 0.25 | 0.25 | 0.68 | 0.50 | 0.030     | 0.25          | 0.090       | 1000               |
| MU14-6FLK       | 01857         | 16-14            | 6         | 0.27            | 0.25 | 0.25 | 0.68 | 0.50 | 0.030     | 0.25          | 0.090       | 1000               |
| MU14-8FLK       | 01858         | 16-14            | 8         | 0.34            | 0.30 | 0.25 | 0.68 | 0.50 | 0.030     | 0.25          | 0.090       | 1000               |
| MU14-10FLK      | 01859         | 16-14            | 10        | 0.35            | 0.32 | 0.25 | 0.68 | 0.50 | 0.030     | 0.25          | 0.090       | 1000               |
| MU14-14FLK      | 01860         | 16-14            | 1/4       | 0.48            | 0.43 | 0.40 | 0.90 | 0.65 | 0.030     | 0.25          | 0.090       | 1000               |

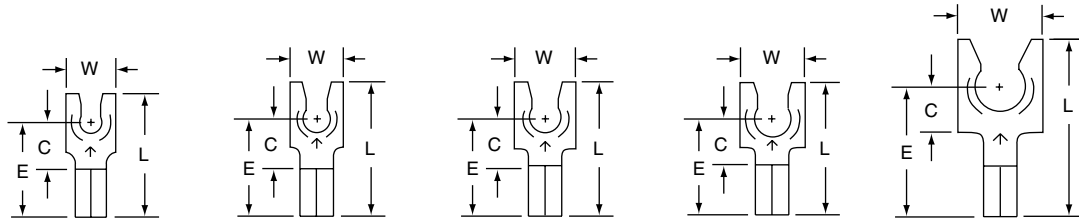

MU14-4FL

MU14-6FL

MU14-8FL

MU14-10FL

MU14-14FL

Stud Size

4

6

8

10

1/4

Wire Range

16-14

16-14

16-14

16-14

16-14

## 3M™ Locking Forks — Non-Insulated Butted Seam 12-10 AWG



| Product Number* | UPC (054007-) | Wire Range (AWG) | Stud Size | Max. Lock Width | W    | C    | L    | E    | Thickness | Barrel Length | Barrel I.D. | Terminals per Case |
|-----------------|---------------|------------------|-----------|-----------------|------|------|------|------|-----------|---------------|-------------|--------------------|
| MU10-6FLK       | 02102         | 12-10            | 6         | 0.30            | 0.28 | 0.28 | 0.73 | 0.53 | 0.040     | 0.25          | 0.135       | 500                |
| MU10-8FLK       | 02103         | 12-10            | 8         | 0.35            | 0.32 | 0.28 | 0.73 | 0.53 | 0.040     | 0.25          | 0.135       | 500                |
| MU10-10FLK      | 02104         | 12-10            | 10        | 0.36            | 0.32 | 0.28 | 0.73 | 0.53 | 0.040     | 0.25          | 0.135       | 500                |
| MU10-14FLK      | 02105         | 12-10            | 1/4       | 0.48            | 0.43 | 0.44 | 0.94 | 0.69 | 0.040     | 0.25          | 0.135       | 500                |

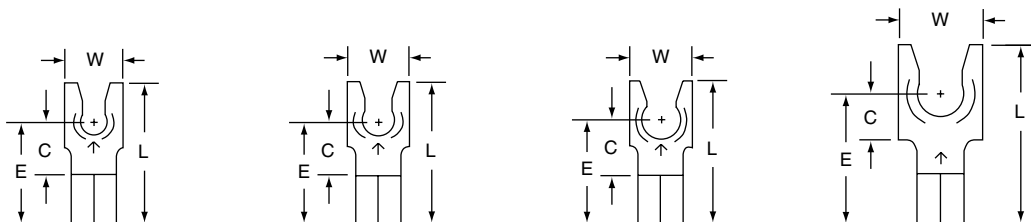

MU10-6FL

MU10-8FL

MU10-10FL

MU10-14FL

Stud Size

6

8

10

1/4

Wire Range

12-10

12-10

12-10

12-10

\*Product number ending in X = box; product number ending with K = bulk.

### 3M™ Locking Forks — Non-Insulated Brazed Seam 22-18 AWG



| Product Number | UPC (054007-) | Wire Range (AWG) | Stud Size | Max Lock Width | W    | C    | L    | E    | Thickness | Barrel Length | Barrel I.D. | Maximum Insulation Diameter | Terminals per Carton | Terminals per Case |
|----------------|---------------|------------------|-----------|----------------|------|------|------|------|-----------|---------------|-------------|-----------------------------|----------------------|--------------------|
| MV18-4FLX      | 13856         | 22-18            | 4         | 0.27           | 0.25 | 0.25 | 0.88 | 0.70 | 0.030     | 0.25          | 0.070       | 0.145                       | 100                  | 500                |
| MV18-4FLK      | 13857         | 22-18            | 4         | 0.27           | 0.25 | 0.25 | 0.88 | 0.70 | 0.030     | 0.25          | 0.070       | 0.145                       | —                    | 1000               |
| MV18-6FLX      | 13864         | 22-18            | 6         | 0.27           | 0.25 | 0.25 | 0.88 | 0.70 | 0.030     | 0.25          | 0.070       | 0.145                       | 100                  | 500                |
| MV18-6FLK      | 13865         | 22-18            | 6         | 0.27           | 0.25 | 0.25 | 0.88 | 0.70 | 0.030     | 0.25          | 0.070       | 0.145                       | —                    | 1000               |
| MV18-8FLX      | 13872         | 22-18            | 8         | 0.34           | 0.30 | 0.25 | 0.88 | 0.70 | 0.030     | 0.25          | 0.070       | 0.145                       | 100                  | 500                |
| MV18-8FLK      | 13873         | 22-18            | 8         | 0.34           | 0.30 | 0.25 | 0.88 | 0.70 | 0.030     | 0.25          | 0.070       | 0.145                       | —                    | 1000               |
| MV18-10FLX     | 13890         | 22-18            | 10        | 0.35           | 0.32 | 0.25 | 0.88 | 0.70 | 0.030     | 0.25          | 0.070       | 0.145                       | 100                  | 500                |
| MV18-10FLK     | 13891         | 22-18            | 10        | 0.35           | 0.32 | 0.25 | 0.88 | 0.70 | 0.030     | 0.25          | 0.070       | 0.145                       | —                    | 1000               |

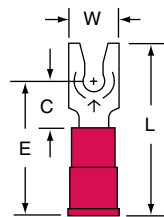

MV18-4FL

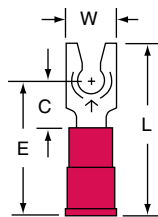

MV18-6FL

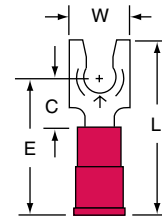

MV18-8FL

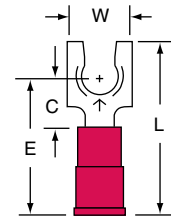

MV18-10FL

Stud Size

4

6

8

10

Wire Range

22-18

22-18

22-18

22-18

### 3M™ Locking Forks — Non-Insulated Brazed Seam 16-14 AWG



| Product Number | UPC (054007-) | Wire Range (AWG) | Stud Size | Max Lock Width | W    | C    | L    | E    | Thickness | Barrel Length | Barrel I.D. | Maximum Insulation Diameter | Terminals per Carton | Terminals per Case |
|----------------|---------------|------------------|-----------|----------------|------|------|------|------|-----------|---------------|-------------|-----------------------------|----------------------|--------------------|
| MV14-4FLX      | 13898         | 16-14            | 4         | 0.27           | 0.25 | 0.25 | 0.88 | 0.70 | 0.030     | 0.25          | 0.090       | 0.170                       | 100                  | 500                |
| MV14-6FLX      | 13906         | 16-14            | 6         | 0.27           | 0.25 | 0.25 | 0.88 | 0.70 | 0.030     | 0.25          | 0.090       | 0.170                       | 100                  | 500                |
| MV14-6FLK      | 13907         | 16-14            | 6         | 0.27           | 0.25 | 0.25 | 0.88 | 0.70 | 0.030     | 0.25          | 0.090       | 0.170                       | —                    | 1000               |
| MV14-8FLX      | 13914         | 16-14            | 8         | 0.34           | 0.30 | 0.25 | 0.88 | 0.70 | 0.030     | 0.25          | 0.090       | 0.170                       | 100                  | 500                |
| MV14-8FLK      | 13915         | 16-14            | 8         | 0.34           | 0.30 | 0.25 | 0.88 | 0.70 | 0.030     | 0.25          | 0.090       | 0.170                       | —                    | 1000               |
| MV14-10FLX     | 13922         | 16-14            | 10        | 0.35           | 0.32 | 0.25 | 0.88 | 0.70 | 0.030     | 0.25          | 0.090       | 0.170                       | 100                  | 500                |
| MV14-10FLK     | 13923         | 16-14            | 10        | 0.35           | 0.32 | 0.25 | 0.88 | 0.70 | 0.030     | 0.25          | 0.090       | 0.170                       | —                    | 1000               |
| MV14-14FLX     | 13940         | 16-14            | 1/4       | 0.48           | 0.43 | 0.40 | 1.10 | 0.85 | 0.030     | 0.25          | 0.090       | 0.170                       | 100                  | 500                |
| MV14-14FLK     | 13941         | 16-14            | 1/4       | 0.48           | 0.43 | 0.40 | 1.10 | 0.85 | 0.030     | 0.25          | 0.090       | 0.170                       | —                    | 1000               |

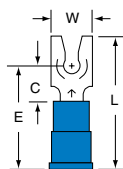

MV14-4FL

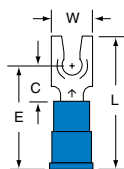

MV14-6FL

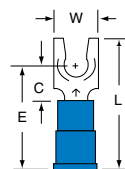

MV14-8FL

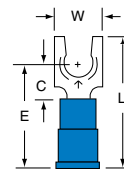

MV14-10FL

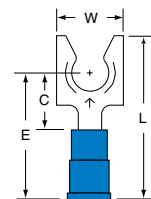

MV14-14FL

Stud Size

4

6

8

10

1/4

Wire Range

16-14

16-14

16-14

16-14

16-14

\*Product number ending in X = box; product number ending with K = bulk.

## 3M™ Locking Forks — Vinyl Insulated Brazed Seam 12-10 AWG



| Product Number <sup>1</sup> | UPC (054007-) | Wire Range (AWG) | Stud Size | Max Lock Width | W    | C    | L    | E    | Thickness | Barrel Length | Barrel I.D. | Maximum Insulation Diameter | Terminals per: Carton | Case |
|-----------------------------|---------------|------------------|-----------|----------------|------|------|------|------|-----------|---------------|-------------|-----------------------------|-----------------------|------|
| MV10-6FLX                   | 13948         | 12-10            | 6         | 0.30           | 0.28 | 0.28 | 1.03 | 0.83 | 0.040     | 0.25          | 0.135       | 0.250                       | 50                    | 500  |
| MV10-6FLK                   | 13949         | 12-10            | 6         | 0.30           | 0.28 | 0.28 | 1.03 | 0.83 | 0.040     | 0.25          | 0.135       | 0.250                       | —                     | 500  |
| MV10-8FLX                   | 13955         | 12-10            | 8         | 0.35           | 0.32 | 0.28 | 1.03 | 0.83 | 0.040     | 0.25          | 0.135       | 0.250                       | 50                    | 500  |
| MV10-8FLK                   | 13956         | 12-10            | 8         | 0.35           | 0.32 | 0.28 | 1.03 | 0.83 | 0.040     | 0.25          | 0.135       | 0.250                       | —                     | 500  |
| MV10-10FLX                  | 13963         | 12-10            | 10        | 0.36           | 0.32 | 0.28 | 1.03 | 0.83 | 0.040     | 0.25          | 0.135       | 0.250                       | 50                    | 500  |
| MV10-10FLK                  | 13964         | 12-10            | 10        | 0.36           | 0.32 | 0.28 | 1.03 | 0.83 | 0.040     | 0.25          | 0.135       | 0.250                       | —                     | 500  |
| MV10-14FLX                  | 13971         | 12-10            | 1/4       | 0.48           | 0.43 | 0.44 | 1.24 | 0.99 | 0.040     | 0.25          | 0.135       | 0.250                       | 50                    | 500  |
| MV10-14FLK                  | 13972         | 12-10            | 1/4       | 0.48           | 0.43 | 0.44 | 1.24 | 0.99 | 0.040     | 0.25          | 0.135       | 0.250                       | —                     | 500  |

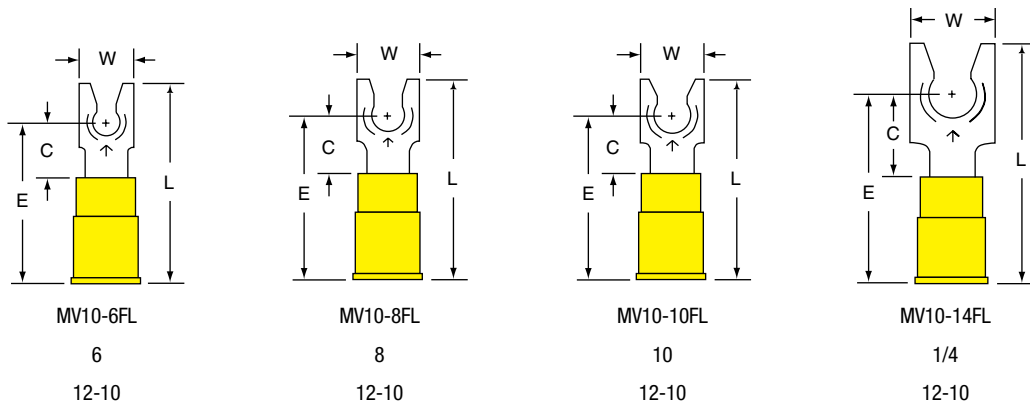

## 3M™ Locking Forks — Vinyl Insulated Butted Seam 22-18 AWG



| Product Number <sup>1</sup> | UPC (054007-) | Wire Range (AWG) | Stud Size | Max Lock Width | W    | C    | L    | E    | Thickness | Barrel Length | Barrel I.D. | Maximum Insulation Diameter | Terminals per: Case |
|-----------------------------|---------------|------------------|-----------|----------------|------|------|------|------|-----------|---------------|-------------|-----------------------------|---------------------|
| MVU18-4FLK                  | 01359         | 22-18            | 4         | 0.27           | 0.25 | 0.25 | 0.88 | 0.70 | 0.030     | 0.25          | 0.070       | 0.145                       | 1000                |
| MVU18-6FLK                  | 01360         | 22-18            | 6         | 0.27           | 0.25 | 0.25 | 0.88 | 0.70 | 0.030     | 0.25          | 0.070       | 0.145                       | 1000                |
| MVU18-8FLK                  | 01361         | 22-18            | 8         | 0.34           | 0.30 | 0.25 | 0.88 | 0.70 | 0.030     | 0.25          | 0.070       | 0.145                       | 1000                |
| MVU18-10FLK                 | 01362         | 22-18            | 10        | 0.35           | 0.32 | 0.25 | 0.88 | 0.70 | 0.030     | 0.25          | 0.070       | 0.145                       | 1000                |

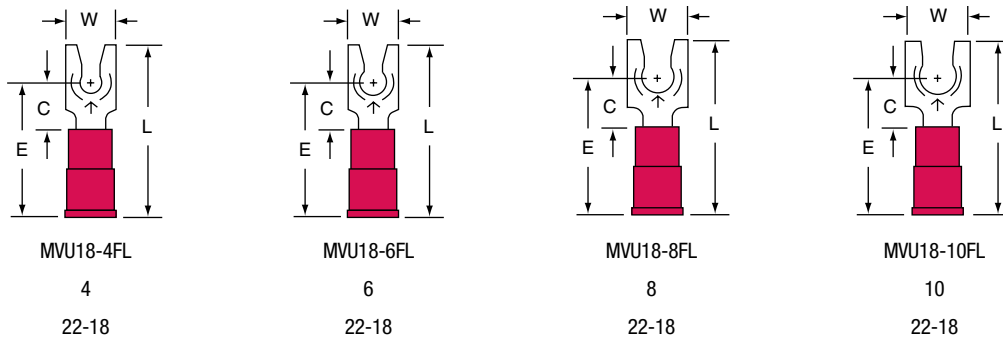

<sup>1</sup>Product number ending in X = box; product number ending with K = bulk.



## 3M™ Locking Forks — Vinyl Insulated Butted Seam 16-14 AWG



| Product Number* | UPC (054007-) | Wire Range (AWG) | Stud Size | Max Lock Width | W    | C    | L    | E    | Thickness | Barrel Length | Barrel I.D. | Maximum Insulation Diameter | Terminals per Case |
|-----------------|---------------|------------------|-----------|----------------|------|------|------|------|-----------|---------------|-------------|-----------------------------|--------------------|
| MVU14-4FLK      | 01871         | 16-14            | 4         | 0.27           | 0.25 | 0.25 | 0.88 | 0.70 | 0.030     | 0.25          | 0.090       | 0.170                       | 1000               |
| MVU14-6FLK      | 01872         | 16-14            | 6         | 0.27           | 0.25 | 0.25 | 0.88 | 0.70 | 0.030     | 0.25          | 0.090       | 0.170                       | 1000               |
| MVU14-8FLK      | 01873         | 16-14            | 8         | 0.34           | 0.30 | 0.25 | 0.88 | 0.70 | 0.030     | 0.25          | 0.090       | 0.170                       | 1000               |
| MVU14-10FLK     | 01874         | 16-14            | 10        | 0.35           | 0.32 | 0.25 | 0.88 | 0.70 | 0.030     | 0.25          | 0.090       | 0.170                       | 1000               |
| MVU14-14FLK     | 01875         | 16-14            | 1/4       | 0.48           | 0.43 | 0.40 | 1.10 | 0.85 | 0.030     | 0.25          | 0.090       | 0.170                       | 1000               |

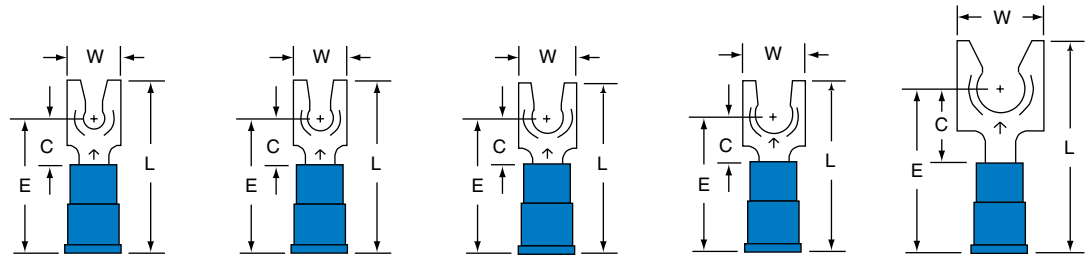

|            |       |       |       |       |       |
|------------|-------|-------|-------|-------|-------|
| Stud Size  | 4     | 6     | 8     | 10    | 1/4   |
| Wire Range | 16-14 | 16-14 | 16-14 | 16-14 | 16-14 |

## 3M™ Locking Forks — Vinyl Insulated Butted Seam 12-10 AWG



| Product Number* | UPC (054007-) | Wire Range (AWG) | Stud Size | Max Lock Width | W    | C    | L    | E    | Thickness | Barrel Length | Barrel I.D. | Maximum Insulation Diameter | Terminals per Case |
|-----------------|---------------|------------------|-----------|----------------|------|------|------|------|-----------|---------------|-------------|-----------------------------|--------------------|
| MVU10-6FLK      | 02114         | 12-10            | 6         | 0.30           | 0.28 | 0.28 | 1.03 | 0.83 | 0.040     | 0.25          | 0.135       | 0.250                       | 500                |
| MVU10-8FLK      | 02115         | 12-10            | 8         | 0.35           | 0.32 | 0.28 | 1.03 | 0.83 | 0.040     | 0.25          | 0.135       | 0.250                       | 500                |
| MVU10-10FLK     | 02116         | 12-10            | 10        | 0.36           | 0.32 | 0.28 | 1.03 | 0.83 | 0.040     | 0.25          | 0.135       | 0.250                       | 500                |
| MVU10-14FLK     | 02117         | 12-10            | 1/4       | 0.48           | 0.43 | 0.44 | 1.24 | 0.99 | 0.040     | 0.25          | 0.135       | 0.250                       | 500                |

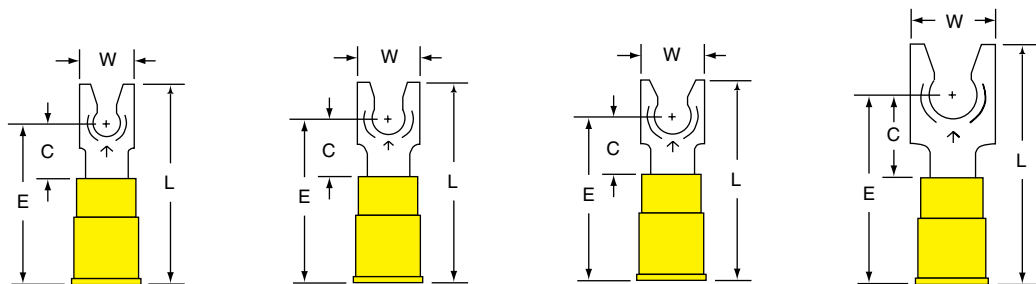

|            |       |       |       |       |
|------------|-------|-------|-------|-------|
| Stud Size  | 6     | 8     | 10    | 1/4   |
| Wire Range | 12-10 | 12-10 | 12-10 | 12-10 |

\*Product number ending in X = box; product number ending with K = bulk.

## 3M™ Locking Forks — Nylon Insulated with Insulation Grip 22-18 AWG



| Product Number* | UPC (054007-) | Wire Range (AWG) | Stud Size | Max Lock Width | W    | C    | L    | E    | Thickness | Barrel Length | Barrel I.D. | Maximum Insulation Diameter | Terminals per: Carton | Case |
|-----------------|---------------|------------------|-----------|----------------|------|------|------|------|-----------|---------------|-------------|-----------------------------|-----------------------|------|
| MNG18-4FLX      | 11706         | 22-18            | 4         | 0.27           | 0.25 | 0.25 | 0.87 | 0.69 | 0.030     | 0.25          | 0.070       | 0.145                       | 100                   | 500  |
| MNG18-4FLK      | 01355         | 22-18            | 4         | 0.27           | 0.25 | 0.25 | 0.87 | 0.69 | 0.030     | 0.25          | 0.070       | 0.145                       | —                     | 1000 |
| MNG18-6FLX      | 11707         | 22-18            | 6         | 0.27           | 0.25 | 0.25 | 0.87 | 0.69 | 0.030     | 0.25          | 0.070       | 0.145                       | 100                   | 500  |
| MNG18-6FLK      | 01356         | 22-18            | 6         | 0.27           | 0.25 | 0.25 | 0.87 | 0.69 | 0.030     | 0.25          | 0.070       | 0.145                       | —                     | 1000 |
| MNG18-8FLX      | 11708         | 22-18            | 8         | 0.34           | 0.30 | 0.25 | 0.87 | 0.69 | 0.030     | 0.25          | 0.070       | 0.145                       | 100                   | 500  |
| MNG18-8FLK      | 01357         | 22-18            | 8         | 0.34           | 0.30 | 0.25 | 0.87 | 0.69 | 0.030     | 0.25          | 0.070       | 0.145                       | —                     | 1000 |
| MNG18-10FLX     | 11709         | 22-18            | 10        | 0.35           | 0.32 | 0.25 | 0.87 | 0.69 | 0.030     | 0.25          | 0.070       | 0.145                       | 100                   | 500  |
| MNG18-10FLK     | 01358         | 22-18            | 10        | 0.35           | 0.32 | 0.25 | 0.87 | 0.69 | 0.030     | 0.25          | 0.070       | 0.145                       | —                     | 1000 |

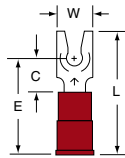

MNG18-4FL

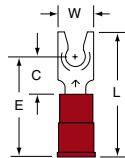

MNG18-6FL

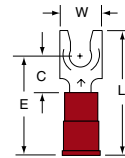

MNG18-8FL

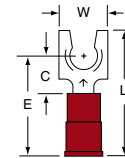

MNG18-10FL

Stud Size

4

6

8

10

Wire Range

22-18

22-18

22-18

22-18

## 3M™ Locking Forks — Nylon Insulated with Insulation Grip 16-14 AWG



| Product Number* | UPC (054007-) | Wire Range (AWG) | Stud Size | Max Lock Width | W    | C    | L    | E    | Thickness | Barrel Length | Barrel I.D. | Maximum Insulation Diameter | Terminals per: Carton | Case |
|-----------------|---------------|------------------|-----------|----------------|------|------|------|------|-----------|---------------|-------------|-----------------------------|-----------------------|------|
| MNG14-4FLX      | 11717         | 16-14            | 4         | 0.27           | 0.25 | 0.25 | 0.89 | 0.71 | 0.030     | 0.25          | 0.090       | 0.170                       | 100                   | 500  |
| MNG14-4FLK      | 01866         | 16-14            | 4         | 0.27           | 0.25 | 0.25 | 0.89 | 0.71 | 0.030     | 0.25          | 0.090       | 0.170                       | —                     | 1000 |
| MNG14-6FLX      | 11718         | 16-14            | 6         | 0.27           | 0.24 | 0.25 | 0.89 | 0.71 | 0.030     | 0.25          | 0.090       | 0.170                       | 100                   | 500  |
| MNG14-6FLK      | 01867         | 16-14            | 6         | 0.27           | 0.24 | 0.25 | 0.89 | 0.71 | 0.030     | 0.25          | 0.090       | 0.170                       | —                     | 1000 |
| MNG14-8FLX      | 11719         | 16-14            | 8         | 0.34           | 0.30 | 0.25 | 0.89 | 0.71 | 0.030     | 0.25          | 0.090       | 0.170                       | 100                   | 500  |
| MNG14-8FLK      | 01868         | 16-14            | 8         | 0.34           | 0.30 | 0.25 | 0.89 | 0.71 | 0.030     | 0.25          | 0.090       | 0.170                       | —                     | 1000 |
| MNG14-10FLX     | 11720         | 16-14            | 10        | 0.35           | 0.32 | 0.25 | 0.89 | 0.71 | 0.030     | 0.25          | 0.090       | 0.170                       | 100                   | 500  |
| MNG14-10FLK     | 01869         | 16-14            | 10        | 0.35           | 0.32 | 0.25 | 0.89 | 0.71 | 0.030     | 0.25          | 0.090       | 0.170                       | —                     | 1000 |
| MNG14-14FLX     | 11721         | 16-14            | 1/4       | 0.48           | 0.43 | 0.40 | 1.11 | 0.86 | 0.030     | 0.25          | 0.090       | 0.170                       | 100                   | 500  |
| MNG14-14FLK     | 01870         | 16-14            | 1/4       | 0.48           | 0.43 | 0.40 | 1.11 | 0.86 | 0.030     | 0.25          | 0.090       | 0.170                       | —                     | 1000 |

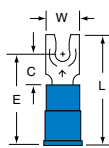

MNG14-4FL

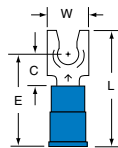

MNG14-6FL

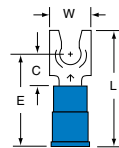

MNG14-8FL

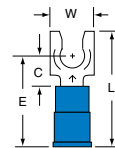

MNG14-10FL

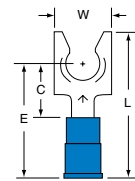

MNG14-14FL

Stud Size

4

6

8

10

1/4

Wire Range

16-14

16-14

16-14

16-14

16-14

\*Product number ending in X = box; product number ending with K = bulk.



### 3M™ Locking Forks — Nylon Insulated with Insulation Grip 12-10 AWG



| Product Number* | UPC (054007-) | Wire Range (AWG) | Stud Size | Max Lock Width | W    | C    | L    | E    | Thickness | Barrel Length | Barrel I.D. | Maximum Insulation Diameter | Terminals per: Carton | Case |
|-----------------|---------------|------------------|-----------|----------------|------|------|------|------|-----------|---------------|-------------|-----------------------------|-----------------------|------|
| MNG10-6FLX      | 11725         | 12-10            | 6         | 0.30           | 0.28 | 0.28 | 1.03 | 0.83 | 0.040     | 0.25          | 0.135       | 0.250                       | 50                    | 500  |
| MNG10-6FLK      | 02106         | 12-10            | 6         | 0.30           | 0.28 | 0.28 | 1.03 | 0.83 | 0.040     | 0.25          | 0.135       | 0.250                       | —                     | 500  |
| MNG10-8FLX      | 11726         | 12-10            | 8         | 0.35           | 0.32 | 0.28 | 1.03 | 0.83 | 0.040     | 0.25          | 0.135       | 0.250                       | 50                    | 500  |
| MNG10-8FLK      | 02107         | 12-10            | 8         | 0.35           | 0.32 | 0.28 | 1.03 | 0.83 | 0.040     | 0.25          | 0.135       | 0.250                       | —                     | 500  |
| MNG10-10FLX     | 11727         | 12-10            | 10        | 0.36           | 0.32 | 0.28 | 1.03 | 0.83 | 0.040     | 0.25          | 0.135       | 0.250                       | 50                    | 500  |
| MNG10-10FLK     | 02108         | 12-10            | 10        | 0.36           | 0.32 | 0.28 | 1.03 | 0.83 | 0.040     | 0.25          | 0.135       | 0.250                       | —                     | 500  |
| MNG10-14FLX     | 11728         | 12-10            | 1/4       | 0.48           | 0.43 | 0.44 | 1.24 | 0.99 | 0.040     | 0.25          | 0.135       | 0.250                       | 50                    | 500  |
| MNG10-14FLK     | 02109         | 12-10            | 1/4       | 0.48           | 0.43 | 0.44 | 1.24 | 0.99 | 0.040     | 0.25          | 0.135       | 0.250                       | —                     | 500  |

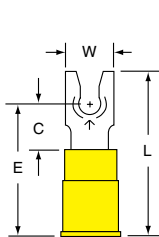

MNG10-6FL

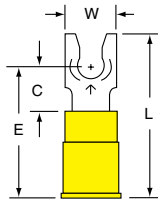

MNG10-8FL

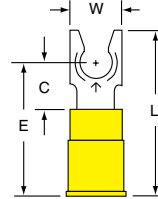

MNG10-10FL

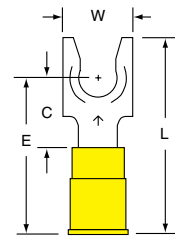

MNG10-14FL

Stud Size

6

8

10

1/4

Wire Range

12-10

12-10

12-10

12-10

### 3M™ Locking Forks — Heat Shrink Brazed Seam 22-18 AWG



| Product Number* | UPC (054007-) | Wire Range (AWG) | Stud Size | W    | C    | L    | E    | Thickness | Barrel Length | Barrel I.D. | Terminals per: Carton | Case |
|-----------------|---------------|------------------|-----------|------|------|------|------|-----------|---------------|-------------|-----------------------|------|
| MH18-6FLX       | 06346         | 22-18            | 6         | 0.25 | 0.15 | 1.00 | 0.76 | 0.030     | 0.25          | 0.070       | 25                    | 100  |
| MH18-6FLK       | 06347         | 22-18            | 6         | 0.25 | 0.15 | 1.00 | 0.76 | 0.030     | 0.25          | 0.070       | —                     | 250  |
| MH18-8FLX       | 06363         | 22-18            | 8         | 0.30 | 0.15 | 1.00 | 0.70 | 0.030     | 0.25          | 0.090       | 25                    | 100  |
| MH18-8FLK       | 06362         | 22-18            | 8         | 0.30 | 0.15 | 1.00 | 0.70 | 0.030     | 0.25          | 0.090       | —                     | 250  |
| MH18-10FLX      | 06352         | 22-18            | 10        | 0.32 | 0.15 | 1.00 | 0.76 | 0.030     | 0.25          | 0.070       | 25                    | 100  |
| MH18-10FLK      | 06353         | 22-18            | 10        | 0.32 | 0.15 | 1.00 | 0.76 | 0.030     | 0.25          | 0.070       | —                     | 250  |

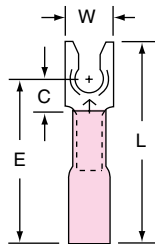

MH18-6FL

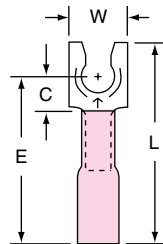

MH18-8FL

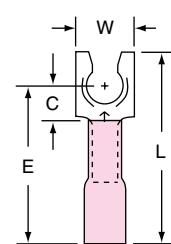

MH18-10FL

Stud Size

6

8

10

Wire Range

22-18

22-18

22-18

\*Product number ending in X = box; product number ending with K = bulk.

## 3M™ Locking Forks — Heat Shrink Brazed Seam 16-14 AWG



| Product Number <sup>1</sup> | UPC (054007-) | Wire Range (AWG) | Stud Size | W    | C    | L    | E    | Thickness | Barrel Length | Barrel I.D. | Terminals per: Bag | Case |
|-----------------------------|---------------|------------------|-----------|------|------|------|------|-----------|---------------|-------------|--------------------|------|
| MH14-6FLX                   | 06322         | 16-14            | 6         | 0.25 | 0.12 | 1.00 | 0.76 | 0.030     | 0.25          | 0.090       | 25                 | 100  |
| MH14-6FLK                   | 06323         | 16-14            | 6         | 0.25 | 0.12 | 1.00 | 0.76 | 0.030     | 0.25          | 0.090       | —                  | 250  |
| MH14-8FLX                   | 06361         | 16-14            | 8         | 0.30 | 0.12 | 1.00 | 0.70 | 0.030     | 0.25          | 0.090       | 25                 | 100  |
| MH14-8FLK                   | 06360         | 16-14            | 8         | 0.30 | 0.12 | 1.00 | 0.70 | 0.030     | 0.25          | 0.090       | —                  | 250  |
| MH14-10FLX                  | 06328         | 16-14            | 10        | 0.32 | 0.12 | 1.00 | 0.76 | 0.030     | 0.25          | 0.090       | 25                 | 100  |
| MH14-10FLK                  | 06329         | 16-14            | 10        | 0.32 | 0.12 | 1.00 | 0.76 | 0.030     | 0.25          | 0.090       | —                  | 250  |
| MH14-14FLX                  | 06332         | 16-14            | 1/4       | 0.43 | 0.27 | 1.1  | 0.85 | 0.030     | 0.25          | 0.090       | 25                 | 100  |
| MH14-14FLK                  | 06333         | 16-14            | 1/4       | 0.43 | 0.27 | 1.1  | 0.85 | 0.030     | 0.25          | 0.090       | —                  | 250  |

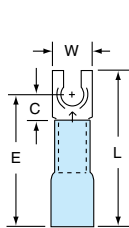

MH14-6FL

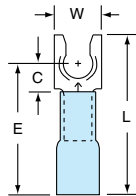

MH14-8FL

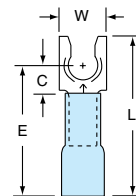

MH14-10FL

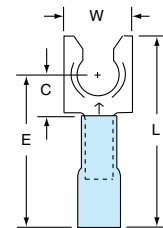

MH14-14FL

Stud Size

6

8

10

1/4

Wire Range

16-14

16-14

16-14

16-14

## 3M™ Locking Forks — Heat Shrink Brazed Seam 12-10 AWG



| Product Number <sup>1</sup> | UPC (054007-) | Wire Range (AWG) | Stud Size | W    | C    | L    | E    | Thickness | Barrel Length | Barrel I.D. | Terminals per: Bag | Case |
|-----------------------------|---------------|------------------|-----------|------|------|------|------|-----------|---------------|-------------|--------------------|------|
| MH10-8FLX                   | 06304         | 12-10            | 8         | 0.32 | 0.16 | 1.00 | 0.80 | 0.040     | 0.25          | 0.135       | 25                 | 100  |
| MH10-8FLK                   | 06358         | 12-10            | 8         | 0.32 | 0.16 | 1.00 | 0.80 | 0.040     | 0.25          | 0.135       | —                  | 250  |
| MH10-10FLX                  | 06307         | 12-10            | 10        | 0.32 | 0.16 | 1.00 | 0.80 | 0.040     | 0.25          | 0.135       | 25                 | 100  |
| MH10-10FLK                  | 06308         | 12-10            | 10        | 0.32 | 0.16 | 1.00 | 0.80 | 0.040     | 0.25          | 0.135       | —                  | 250  |
| MH10-14FLX                  | 06310         | 12-10            | 1/4       | 0.43 | 0.30 | 1.2  | 0.95 | 0.040     | 0.25          | 0.135       | 25                 | 100  |
| MH10-14FLK                  | 06311         | 12-10            | 1/4       | 0.43 | 0.30 | 1.2  | 0.95 | 0.040     | 0.25          | 0.135       | —                  | 250  |

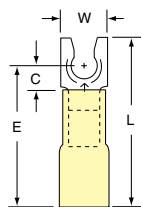

MH10-8FL

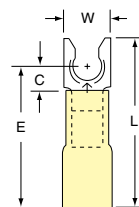

MH10-10FL

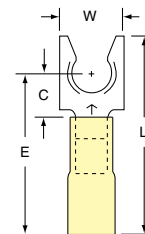

MH10-14FL

Stud Size

8

10

1/4

Wire Range

12-10

12-10

12-10

<sup>1</sup>Product number ending in X = box; product number ending with K = bulk.

# Butt Connectors

## 3M™ Butt Connectors — Non-Insulated Seamless



| Product Number* | UPC (054007-) | Wire Range (AWG) | L    | Thickness | Barrel Length | Barrel I.D. | Terminals per: Carton | Case |
|-----------------|---------------|------------------|------|-----------|---------------|-------------|-----------------------|------|
| M18BCX          | 22187         | 22-18            | 0.63 | 0.031     | 0.28          | 0.062       | 100                   | 500  |
| M18BCK          | 01311         | 22-18            | 0.63 | 0.031     | 0.28          | 0.062       | —                     | 1000 |
| M14BCX          | 23102         | 16-14            | 0.66 | 0.031     | 0.30          | 0.095       | 100                   | 500  |
| M14BCK          | 01816         | 16-14            | 0.66 | 0.031     | 0.30          | 0.095       | —                     | 1000 |
| M10BCX          | 24019         | 12-10            | 0.81 | 0.038     | 0.38          | 0.142       | 50                    | 500  |
| M10BCK          | 02077         | 12-10            | 0.81 | 0.038     | 0.38          | 0.142       | —                     | 500  |

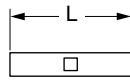

M18BC  
Wire Range 22-18

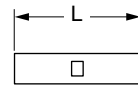

M14BC  
Wire Range 16-14

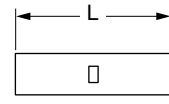

M10BC  
Wire Range 12-10

Wire Range

## 3M™ Butt Connectors — Non-Insulated Brazed Seam



| Product Number* | UPC (054007-) | Wire Range (AWG) | L    | Thickness | Barrel Length | Barrel I.D. | Terminals per: Carton | Case |
|-----------------|---------------|------------------|------|-----------|---------------|-------------|-----------------------|------|
| M8BCX           | 24167         | 8                | 0.81 | 0.050     | 0.38          | 0.175       | 25                    | 250  |
| M8BCK           | 02143         | 8                | 0.81 | 0.050     | 0.38          | 0.175       | —                     | 200  |
| M6BCX           | 24225         | 6                | 1.02 | 0.050     | 0.47          | 0.250       | 20                    | 200  |
| M6BCK           | 02172         | 6                | 1.02 | 0.050     | 0.47          | 0.250       | —                     | 200  |
| M4BCX           | 24282         | 4                | 1.13 | 0.075     | 0.53          | 0.280       | 15                    | 150  |
| M4BCK           | 02197         | 4                | 1.13 | 0.075     | 0.53          | 0.280       | —                     | 200  |

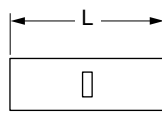

M8BC  
Wire Range 8

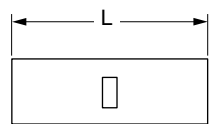

M6BC  
Wire Range 6

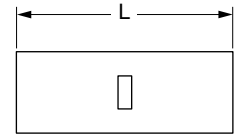

M4BC  
Wire Range 4

Wire Range

\*Product number ending in X = box; product number ending with K = bulk.

## 3M™ Large Gauge Butt Connectors — Non-Insulated Copper Seamless

| Product Number* | UPC (054007-) | Color Code | Wire Range | L               | Barrel I.D.      | Inner Unit Pack. | Case Qty. |
|-----------------|---------------|------------|------------|-----------------|------------------|------------------|-----------|
| MC2BCX          | 09205         | Brown      | 2 AWG      | 1.38" (34,3 mm) | 0.34" (8,6 mm)   | 10/box           | 100       |
| MC1BCX          | 09206         | Green      | 1 AWG      | 1.38" (34,3 mm) | 0.36" (9,3 mm)   | 10/box           | 100       |
| MC1/0BCX        | 09207         | Pink       | 1/0 AWG    | 1.55" (39,4 mm) | 0.41" (10,5 mm)  | 10/box           | 100       |
| MC2/0BCX        | 09208         | Black      | 2/0 AWG    | 1.80" (45,7 mm) | 0.46" (11,8 mm)  | 10/box           | 100       |
| MC3/0BCX        | 09209         | Orange     | 3/0 AWG    | 1.90" (48,3 mm) | 0.51" (13,1 mm)  | 3/box            | 30        |
| MC4/0BCX        | 09210         | Purple     | 4/0 AWG    | 2.00" (50,8 mm) | 0.56" (14,3 mm)  | 3/box            | 30        |
| MC250BCX        | 09211         | Yellow     | 250 kcmil  | 2.25" (50,8 mm) | 0.630" (15,1 mm) | 3/box            | 30        |

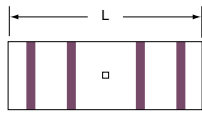

MC2BCX

Wire Range

2

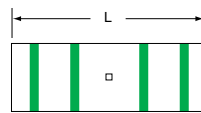

MC1BCX

1

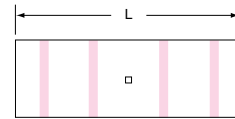

MC1/0BCX

1/0

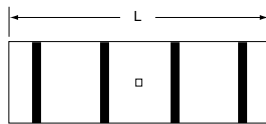

MC2/0BCX

Wire Range

2/0

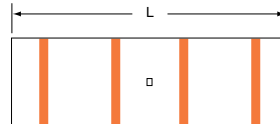

MC3/0BCX

3/0

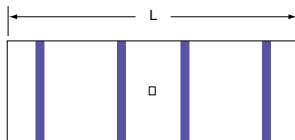

MC4/0BCX

Wire Range

4/0

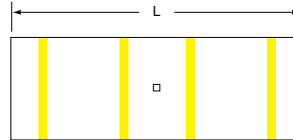

MC250BCX

250 kcmil

## 3M™ Butt Connectors — Vinyl Insulated Seamless



| Product Number* | UPC (054007-) | Wire Range | L                 | Thickness         | Barrel Length    | Barrel I.D.       | Max Insulation Diameter | Inner Unit Pack. | Case Qty. |
|-----------------|---------------|------------|-------------------|-------------------|------------------|-------------------|-------------------------|------------------|-----------|
| MV18BCX         | 22195         | 22-18 AWG  | 0.310" (7,874 mm) | 0.030" (0,762 mm) | 0.250" (6,35 mm) | 0.070" (1,778 mm) | 0.145" (3,683 mm)       | 100/ carton      | 500       |
| MV18BCK         | 01312         | 22-18 AWG  | 0.310" (7,874 mm) | 0.030" (0,762 mm) | 0.250" (6,35 mm) | 0.070" (1,778 mm) | 0.145" (3,683 mm)       |                  | 500       |
| MV14BCX         | 23110         | 16-14 AWG  | 0.310" (7,874 mm) | 0.030" (0,762 mm) | 0.250" (6,35 mm) | 0.090" (2,286 mm) | 0.170" (4,138 mm)       | 100/ carton      | 500       |
| MV14BCK         | 01817         | 16-14 AWG  | 0.310" (7,874 mm) | 0.030" (0,762 mm) | 0.250" (6,35 mm) | 0.090" (2,286 mm) | 0.170" (4,138 mm)       |                  | 500       |
| MV10BCX         | 24027         | 12-10 AWG  | 0.310" (7,874 mm) | 0.040" (1,016 mm) | 0.250" (6,35 mm) | 0.135" (3,429 mm) | 0.250" (6,35 mm)        | 50/ carton       | 500       |
| MV10BCK         | 02078         | 12-10 AWG  | 0.310" (7,874 mm) | 0.040" (1,016 mm) | 0.250" (6,35 mm) | 0.135" (3,429 mm) | 0.250" (6,35 mm)        |                  | 500       |

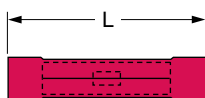

MV18BCX

Wire Range

22-18

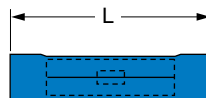

MV14BCX

16-14

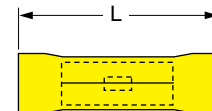

MV10BCX

12-10

\*Product number ending in X = box; product number ending with K = bulk.



## 3M™ Butt Connectors — Nylon Insulated with Insulation Grip



| Product Number <sup>1</sup> | UPC (054007-) | Wire Range (AWG) | L    | Thickness | Barrel Length | Barrel I.D. | Max Insulation Diameter | Terminals per: Carton | Case |
|-----------------------------|---------------|------------------|------|-----------|---------------|-------------|-------------------------|-----------------------|------|
| MNG18BCX                    | 22203         | 22-18            | 1.00 | 0.030     | 0.25          | 0.070       | 0.145                   | 100                   | 500  |
| MNG18BCK                    | 01313         | 22-18            | 1.00 | 0.030     | 0.25          | 0.070       | 0.145                   | —                     | 1000 |
| MNG14BCX                    | 23128         | 16-14            | 1.00 | 0.030     | 0.25          | 0.090       | 0.170                   | 100                   | 500  |
| MNG14BCK                    | 01818         | 16-14            | 1.00 | 0.030     | 0.25          | 0.090       | 0.170                   | —                     | 1000 |
| MNG10BCX                    | 24035         | 12-10            | 1.15 | 0.040     | 0.25          | 0.135       | 0.250                   | 50                    | 500  |
| MNG10BCK                    | 15967         | 12-10            | 1.15 | 0.040     | 0.25          | 0.135       | 0.250                   | —                     | 500  |

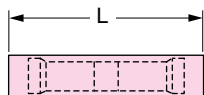

MNG18BC

Wire Range

22-18

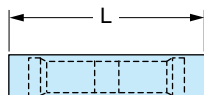

MNG14BC

16-14

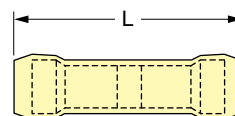

MNG10BC

12-10

## 3M™ Butt Connectors — Nylon Insulated with Insulation Grip Moisture Resistant<sup>®</sup>

| Product Number <sup>1</sup> | UPC (051138-) | Wire Range (AWG) | L    | Terminals per: Carton | Case |
|-----------------------------|---------------|------------------|------|-----------------------|------|
| MNG18BCMX-A                 | 98027         | 22-18            | 1.02 | 25                    | 250  |
| MNG18BCMK-A                 | 98029         | 22-18            | 1.02 | —                     | 1000 |
| MNG14BCMX-A                 | 98032         | 16-14            | 1.02 | 25                    | 250  |
| MNG14BCMK-A                 | 98035         | 16-14            | 1.06 | —                     | 1000 |
| MNG10BCMX-A                 | 98037         | 12-10            | 1.23 | 25                    | 250  |
| MNG10BCMK-A                 | 98039         | 12-10            | 1.23 | —                     | 500  |

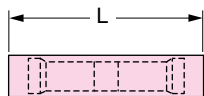

MNG18BCM-A

Wire Range

22-18

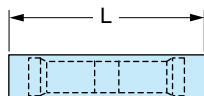

MNG14BCM-A

16-14

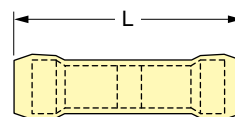

MNG10BCM-A

12-10

## 3M™ Butt Connectors — Heat Shrink Seamless

| Product Number <sup>1</sup> | UPC (054007-) | Wire Range (AWG) | L   | Thickness | Barrel Length | Barrel I.D. | Terminals per: Bag | Case |
|-----------------------------|---------------|------------------|-----|-----------|---------------|-------------|--------------------|------|
| MH18BCX                     | 06342         | 22-18            | 1.2 | 0.031     | 0.28          | 0.062       | 25                 | 100  |
| MH18BCK                     | 06343         | 22-18            | 1.2 | 0.031     | 0.28          | 0.062       | —                  | 250  |
| MH14BCX                     | 06318         | 16-14            | 1.3 | 0.031     | 0.30          | 0.095       | 25                 | 100  |
| MH14BCK                     | 06319         | 16-14            | 1.3 | 0.031     | 0.30          | 0.095       | —                  | 250  |
| MH10BCX                     | 06300         | 12-10            | 1.5 | 0.031     | 0.38          | 0.142       | 25                 | 100  |
| MH10BCK                     | 06301         | 12-10            | 1.5 | 0.031     | 0.38          | 0.142       | —                  | 250  |

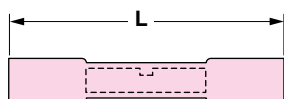

MH18BC

Wire Range

22-18

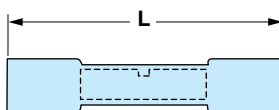

MH14BC

16-14

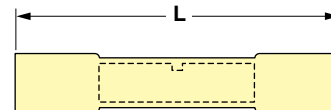

MH10BC

12-10

<sup>1</sup>Product number ending in X = box; product number ending with K = bulk.



## 3M™ Step-Down Butt Connectors — Non-Insulated

| Part Number | Min. Order Qty. | UPC 051128- | Side #1      |            | Side #2      |            |
|-------------|-----------------|-------------|--------------|------------|--------------|------------|
|             |                 |             | Color Stripe | Wire Gauge | Color Stripe | Wire Gauge |
| SD-610-S    | 1000            | 57020       | White        | 22-24 AWG  | Red          | 18-20 AWG  |
| SD-621-S    | 1000            | 57021       | Red          | 18-20 AWG  | Blue         | 14-16 AWG  |
| SD-632-S    | 1000            | 57022       | Blue         | 14-16 AWG  | Yellow       | 10-12 AWG  |
| SD-643-S    | 1000            | 57023       | Yellow       | 10-12 AWG  | Red          | 8 AWG      |

## 3M™ Step-Down Butt Connectors — Vinyl

| Part Number | Min. Order Qty. | UPC 051128- | Side #1      |            | Side #2      |            |
|-------------|-----------------|-------------|--------------|------------|--------------|------------|
|             |                 |             | Color Stripe | Wire Gauge | Color Stripe | Wire Gauge |
| SD-610-SP   | 1000            | 57024       | White        | 22-24 AWG  | Red          | 18-20 AWG  |
| SD-621-SP   | 1000            | 57025       | Red          | 18-20 AWG  | Blue         | 14-16 AWG  |
| SD-632-SP   | 1000            | 57026       | Blue         | 14-16 AWG  | Yellow       | 10-12 AWG  |
| SD-643-SP   | 1000            | 57027       | Yellow       | 10-12 AWG  | Red          | 8 AWG      |

## 3M™ Step-Down Butt Connectors — Heat Shrink

| Part Number | Min. Order Qty. | UPC 051128- | Heat Shrink Tubing Color | Side #1      |            | Side #2      |            |
|-------------|-----------------|-------------|--------------------------|--------------|------------|--------------|------------|
|             |                 |             |                          | Color Stripe | Wire Gauge | Color Stripe | Wire Gauge |
| SD-610-SHS  | 1000            | 57028       | Red                      | White        | 22-24 AWG  | Red          | 18-20 AWG  |
| SD-621-SHS  | 1000            | 57029       | Blue                     | Red          | 18-20 AWG  | Blue         | 14-16 AWG  |
| SD-632-SHS  | 1000            | 57030       | Yellow                   | Blue         | 14-16 AWG  | Yellow       | 10-12 AWG  |
| SD-643-SHS  | 1000            | 57031       | Pink                     | Yellow       | 10-12 AWG  | Red          | 8 AWG      |

\*Product number ending in X = box; product number ending with K = bulk.

## 3M™ Multiple Wire Heat Shrink Butt Connectors

| Part Number | Min. Order Qty. | UPC 051128- | Wire Gauge | Tubing Color        | Color Stripe on Connector     | Wire                          |
|-------------|-----------------|-------------|------------|---------------------|-------------------------------|-------------------------------|
| MW-60-SHS   | 250             | 57032       | 24-22 AWG  | Clear/White Dashes  | Side 1: White / Side 2: Red   | One 22-24 AWG / Two 22-24 AWG |
| MW-61-SHS   | 250             | 57033       | 20-18 AWG  | Clear/Red Dashes    | Side 1: Red / Side 2: Blue    | One 18-20 AWG / Two 18-20 AWG |
| MW-62-SHS   | 250             | 57034       | 16-14 AWG  | Clear/Blue Dashes   | Side 1: Blue / Side 2: Yellow | One 14-16 AWG / Two 14-16 AWG |
| MW-63-SHS   | 250             | 57035       | 12-10 AWG  | Clear/Yellow Dashes | Side 1: Yellow / Side 2: Red  | One 10-12 AWG / Two 10-12 AWG |

## 3M™ Step-Down Butt Connectors — Non-Insulated

| Part Number | Min. Order Qty. | UPC 051128- | Connector Wire Gauge | Tubing Color        |
|-------------|-----------------|-------------|----------------------|---------------------|
| 722-NHS     | 250             | 57208       | 22-14 AWG            | Clear/Blue Dashes   |
| 718-NHS     | 250             | 57207       | 18-10 AWG            | Clear/Yellow Dashes |

\*Product number ending in X = box; product number ending with K = bulk.

# Female Disconnects

## 3M™ Female Disconnects — Non-Insulated Butted Seam



| Product Number <sup>1</sup> | UPC (054007-) | Wire Range (AWG)** | Mates with Male Tab Width (W') x Thickness | L    | Barrel Length | Barrel I.D. | Terminals per: Carton | Case |
|-----------------------------|---------------|--------------------|--|------|---------------|-------------|-----------------------|------|
| MU20-110DFK-A*              | 00984         | 26-20              | 0.110 x 0.020                              | 0.48 | —             | —           | —                     | 1000 |
| MU20-110/32DFK-A*           | 00985         | 26-20              | 0.110 x 0.032                              | 0.48 | —             | —           | —                     | 1000 |
| MU18-187DFK                 | 02366         | 22-18              | 0.187 x 0.020                              | 0.58 | 0.25          | 0.085       | —                     | 1000 |
| MU18-250DFX                 | 16725         | 22-18              | 0.250 x 0.032                              | 0.66 | 0.25          | 0.080       | 100                   | 500  |
| MU18-250DFK                 | 01300         | 22-18              | 0.250 x 0.032                              | 0.66 | 0.25          | 0.080       | —                     | 1000 |
| MU14-110DFX-A*              | 57448***      | 16-14              | 0.110 x 0.020                              | 0.54 | 0.19          | 0.115       | 100                   | 500  |
| MU14-110DFK*                | 13995         | 16-14              | 0.110 x 0.020                              | 0.54 | 0.19          | 0.115       | —                     | 1000 |
| MU14-187DFX                 | 22831         | 16-14              | 0.187 x 0.020                              | 0.58 | 0.25          | 0.085       | 100                   | 500  |
| MU14-187DFK                 | 01767         | 16-14              | 0.187 x 0.020                              | 0.58 | 0.25          | 0.085       | —                     | 1000 |
| MU14-250DFX                 | 22849         | 16-14              | 0.250 x 0.032                              | 0.66 | 0.25          | 0.080       | 100                   | 500  |
| MU14-250DFK                 | 01768         | 16-14              | 0.250 x 0.032                              | 0.66 | 0.25          | 0.080       | —                     | 1000 |

\* Not UL Listed or CSA Certified  
 \*\* For #10-12 AWG, see MI10-250DF  
 \*\*\* UPC prefix 051128

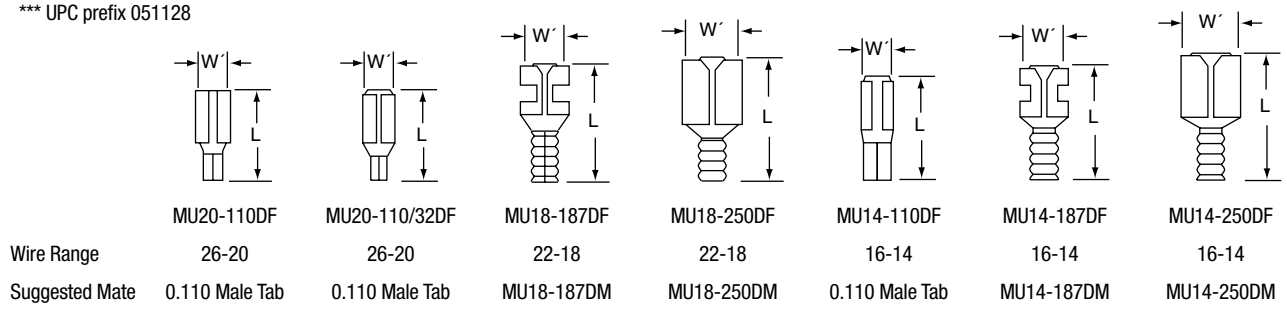

## 3M™ Female Disconnects — Non-Insulated Interlock Barrel



| Product Number <sup>1</sup> | UPC (054007-) | Wire Range (AWG)** | Mates with Male Tab Width (W') x Thickness | L    | Barrel Length | Barrel I.D. | Terminals per: Carton | Case |
|-----------------------------|---------------|--------------------|--|------|---------------|-------------|-----------------------|------|
| MI18-250DFX                 | 09979         | 22-18              | 0.250 x 0.032                              | 0.63 | 0.25          | 0.076       | 100                   | 500  |
| MI18-250DFK                 | 69561         | 22-18              | 0.250 x 0.032                              | 0.63 | 0.25          | 0.076       | —                     | 1000 |
| MI14-250DFX                 | 09977         | 16-14              | 0.250 x 0.032                              | 0.63 | 0.25          | 0.076       | 100                   | 500  |
| MI14-250DFK                 | 69559         | 16-14              | 0.250 x 0.032                              | 0.63 | 0.25          | 0.076       | —                     | 1000 |
| MI10-250DFX                 | 09975         | 12-10              | 0.250 x 0.032                              | 0.64 | 0.25          | 0.128       | 50                    | 500  |
| MI10-250DFK                 | 69557         | 12-10              | 0.250 x 0.032                              | 0.64 | 0.25          | 0.128       | —                     | 500  |

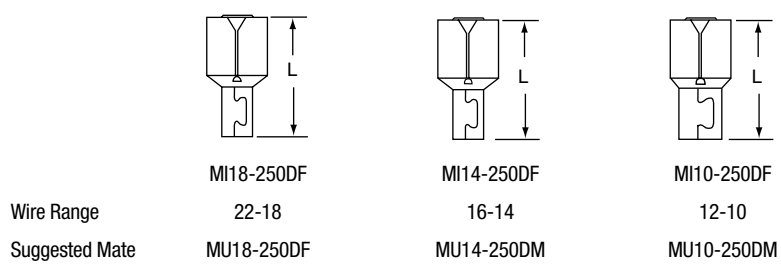

<sup>1</sup>Product number ending in X = box; product number ending with K = bulk.

### 3M™ Female Disconnects — Non-Insulated Butted Seam Flag



| Product Number <sup>†</sup> | UPC (054007-) | Wire Range (AWG) | Mates with Male Tab Width (W') x Thickness | L    | Barrel Length | Barrel I.D. | Terminals per: Carton | Case |
|-----------------------------|---------------|------------------|--|------|---------------|-------------|-----------------------|------|
| MU18-187DF/FLAG*            | 22138         | 22-18            | 0.187 x 0.020                              | 0.46 | 0.20          | 0.075       | 100                   | 500  |
| MU18-187DF/FLAG*            | 01302         | 22-18            | 0.187 x 0.020                              | 0.46 | 0.20          | 0.075       | —                     | 1000 |
| MU18-250DF/FLAGX            | 22146         | 22-18            | 0.250 x 0.032                              | 0.50 | 0.25          | 0.075       | 100                   | 500  |
| MU18-250DF/FLAGK            | 01303         | 22-18            | 0.250 x 0.032                              | 0.50 | 0.25          | 0.075       | —                     | 1000 |
| MU14-187DF/FLAG*            | 22948         | 16-14            | 0.187 x 0.020                              | 0.47 | 0.20          | 0.095       | 100                   | 500  |
| MU14-187DF/FLAG*            | 01778         | 16-14            | 0.187 x 0.020                              | 0.47 | 0.20          | 0.095       | —                     | 1000 |
| MU14-250DF/FLAGX            | 22955         | 16-14            | 0.250 x 0.032                              | 0.51 | 0.26          | 0.095       | 100                   | 500  |
| MU14-250DF/FLAGK            | 01779         | 16-14            | 0.250 x 0.032                              | 0.51 | 0.26          | 0.095       | —                     | 1000 |

\* Not UL Listed or CSA Certified

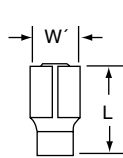

MU18-187DF/FLAG

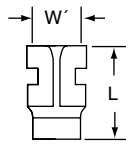

MU18-250DF/FLAG

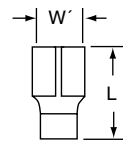

MU14-187DF/FLAG

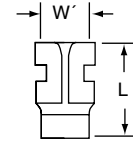

MU14-250DF/FLAG

Wire Range

22-18

22-18

16-14

16-14

Suggested Mate

0.187 Male Tab

0.250 Male Tab

0.187 Male Tab

0.250 Male Tab

### 3M™ Female Disconnects — Vinyl Insulated Butted Seam



| Product Number <sup>†</sup> | UPC (054007-) | Wire Range (AWG)** | Mates with Male Tab Width (W') x Thickness | L    | Barrel Length | Barrel I.D. | Maximum Insulation Diameter | Terminals per: Carton | Case |
|-----------------------------|---------------|--------------------|--|------|---------------|-------------|-----------------------------|-----------------------|------|
| MVU18-187DFK                | 02368         | 22-18              | 0.187 x 0.020                              | 0.78 | 0.25          | 0.085       | 0.145                       | —                     | 1000 |
| MVU18-250DFX                | 11820         | 22-18              | 0.250 x 0.032                              | 0.87 | 0.25          | 0.080       | 0.145                       | 100                   | 500  |
| MVU18-250DFK                | 01301         | 22-18              | 0.250 x 0.032                              | 0.87 | 0.25          | 0.080       | 0.145                       | —                     | 1000 |
| MVU14-110DFK-A*             | 57438***      | 16-14              | 0.110 x 0.020                              | 0.73 | —             | —           | 0.18                        | —                     | 1000 |
| MVU14-187DFX                | 22872         | 16-14              | 0.187 x 0.020                              | 0.78 | 0.25          | 0.085       | 0.145                       | 100                   | 500  |
| MVU14-187DFK                | 01776         | 16-14              | 0.187 x 0.020                              | 0.78 | 0.25          | 0.085       | 0.145                       | —                     | 1000 |
| MVU14-250DFX                | 22880         | 16-14              | 0.250 x 0.032                              | 0.87 | 0.25          | 0.080       | 0.145                       | 100                   | 500  |
| MVU14-250DFK                | 01777         | 16-14              | 0.250 x 0.032                              | 0.87 | 0.25          | 0.080       | 0.145                       | —                     | 1000 |

\* Not UL Listed or CSA Certified

\*\* For #10-12 AWG, MVU10-250DF has been substituted with MVU10-250DF.

\*\*\* UPC prefix 051128

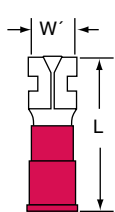

MVU18-187DF

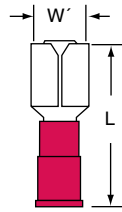

MVU18-250DF

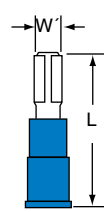

MVU14-110DF-A

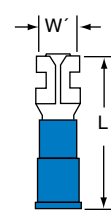

MVU14-187DF

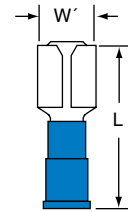

MVU14-250DF

Wire Range

22-18

22-18

16-14

16-14

16-14

Suggested Mate

MVU18-187DM

MVU18-250DM

0.110 Male Tab

MVU14-187DM

MVU14-250DM

† Product number ending in X = box; product number ending with K = bulk.



### 3M™ Female Disconnects — Vinyl Insulated Interlock Barrel



| Product Number <sup>†</sup> | UPC (054007-) | Wire Range (AWG) | Mates with Male Tab Width (W') x Thickness | L    | Barrel Length | Barrel I.D. | Maximum Insulation Diameter | Terminals per: Carton | Case |
|-----------------------------|---------------|------------------|--|------|---------------|-------------|-----------------------------|-----------------------|------|
| MVI18-187DFX                | 09996         | 22-18            | 0.187 x 0.020                              | 0.77 | 0.25          | 0.080       | 0.145                       | 100                   | 500  |
| MVI18-187DFK                | 69581         | 22-18            | 0.187 x 0.020                              | 0.77 | 0.25          | 0.080       | 0.145                       | —                     | 1000 |
| MVI18-250DFX                | 09997         | 22-18            | 0.250 x 0.032                              | 0.83 | 0.25          | 0.076       | 0.145                       | 100                   | 500  |
| MVI18-250DFK                | 69582         | 22-18            | 0.250 x 0.032                              | 0.83 | 0.25          | 0.076       | 0.145                       | —                     | 1000 |
| MVI14-187DFX                | 09999         | 16-14            | 0.187 x 0.020                              | 0.77 | 0.25          | 0.080       | 0.145                       | 100                   | 500  |
| MVI14-187DFK                | 69579         | 16-14            | 0.187 x 0.020                              | 0.77 | 0.25          | 0.080       | 0.145                       | —                     | 1000 |
| MVI14-250DFX                | 69556         | 16-14            | 0.250 x 0.032                              | 0.83 | 0.25          | 0.076       | 0.145                       | 100                   | 500  |
| MVI14-250DFK                | 69580         | 16-14            | 0.250 x 0.032                              | 0.83 | 0.25          | 0.076       | 0.145                       | —                     | 1000 |
| MVI10-250DFX                | 09998         | 12-10            | 0.250 x 0.032                              | 0.95 | 0.25          | 0.128       | 0.250                       | 50                    | 500  |
| MVI10-250DFK                | 69578         | 12-10            | 0.250 x 0.032                              | 0.95 | 0.25          | 0.128       | 0.250                       | —                     | 500  |

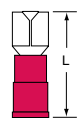

MVI18-187DF

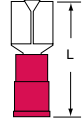

MVI18-250DF

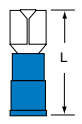

MVI14-187DF

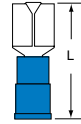

MVI14-250DF

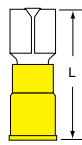

MVI10-250DF

Wire Range            22-18  
Suggested Mate      MVU18-187DM

Wire Range            22-18  
Suggested Mate      MVU18-250DM

Wire Range            16-14  
Suggested Mate      MVU14-187DM

Wire Range            16-14  
Suggested Mate      MVU14-250DM

Wire Range            12-10  
Suggested Mate      MVU10-250DM

### 3M™ Female Disconnects — Nylon Insulated with Insulation Grip



| Product Number <sup>†</sup> | UPC (054007-) | Wire Range (AWG)** | Mates with Male Tab Width (W') x Thickness | L    | Barrel Length | Barrel I.D. | Maximum Insulation Diameter | Terminals per: Carton | Case |
|-----------------------------|---------------|--------------------|--|------|---------------|-------------|-----------------------------|-----------------------|------|
| MNG18-110DFX-A              | 57444**       | 22-18              | 0.187 x 0.020                              | 0.77 | 0.25          | 0.085       | 0.145                       | —                     | 1000 |
| MNG18-110DFK-A              | 57445**       | 22-18              | 0.250 x 0.032                              | 0.86 | 0.25          | 0.080       | 0.145                       | 100                   | 500  |
| MNG18-187DFK                | 02405         | 22-18              | 0.110 x 0.020                              | 0.77 | —             | —           | 0.16                        | —                     | —    |
| MNG18-250DFX                | 02393         | 22-18              | 0.110 x 0.020                              | 0.77 | —             | —           | 0.16                        | —                     | —    |
| MNG18-250DFK                | 02369         | 22-18              | 0.250 x 0.032                              | 0.86 | 0.25          | 0.080       | 0.145                       | —                     | 1000 |
| MNG14-110DFX-A*             | 57427**       | 16-14              | 0.110 x 0.020                              | 0.77 | —             | —           | 0.20                        | 100                   | 500  |
| MNG14-110DFK-A*             | 57437**       | 16-14              | 0.110 x 0.020                              | 0.77 | —             | —           | 0.20                        | —                     | 1000 |
| MNG14-187DFX                | 22914         | 16-14              | 0.187 x 0.020                              | 0.77 | 0.25          | 0.085       | 0.145                       | 100                   | 500  |
| MNG14-187DFK                | 01773         | 16-14              | 0.187 x 0.020                              | 0.77 | 0.25          | 0.085       | 0.145                       | —                     | 1000 |
| MNG14-250DFX                | 22930         | 16-14              | 0.250 x 0.032                              | 0.86 | 0.25          | 0.080       | 0.145                       | 100                   | 500  |
| MNG14-250DFK                | 01774         | 16-14              | 0.250 x 0.032                              | 0.86 | 0.25          | 0.080       | 0.145                       | —                     | 1000 |
| MNG10-375DFK*               | 02053         | 12-10              | 0.375 x 0.050                              | 1.23 | 0.25          | 0.175       | 0.250                       | —                     | 500  |

\* Not UL Listed or CSA Certified  
\*\* UPC prefix 051128

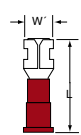

MNG18-187DF

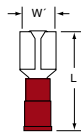

MNG18-250DF

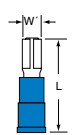

MNG14-110DF-A

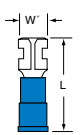

MNG14-187DF

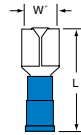

MNG14-250DF

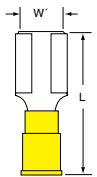

MNG10-375DF

Wire Range            22-18  
Suggested Mate      MNG18-187DM

Wire Range            22-18  
Suggested Mate      MNG18-250DM

Wire Range            16-14  
Suggested Mate      0.110 Male Tab

Wire Range            16-14  
Suggested Mate      MNG14-187DM

Wire Range            16-14  
Suggested Mate      MNG14-250DM

Wire Range            12-10  
Suggested Mate      0.375 Male Tab

<sup>†</sup>Product number ending in X = box; product number ending with K = bulk.

## 3M™ Female Disconnects — Vinyl Insulated with Insulation Grip

| Product Number <sup>1</sup> | UPC (054007-) | Wire Range (AWG) | Mates with Male Tab Width (W') x Thickness | L    | Barrel Length | Barrel I.D. | Maximum Insulation Diameter | Terminals per: Carton | Case |
|-----------------------------|---------------|------------------|--|------|---------------|-------------|-----------------------------|-----------------------|------|
| MVG24-110DFK*               | 95151         | 26-20            | 0.110 x 0.020                              | 0.63 | 0.13          | 0.055       | 0.093                       | —                     | 1000 |
| MVG24-110/32DFX*            | 95176         | 26-20            | 0.110 x 0.032                              | 0.63 | 0.13          | 0.055       | 0.093                       | 100                   | 500  |

\* Not UL Listed or CSA Certified

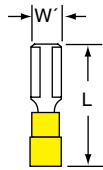

MVG24-110DF

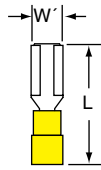

MVG24-110/32DF

Wire Range

26-20

26-20

Suggested Mate

0.110 Male Tab

0.110 Male Tab

## 3M™ Female Disconnects — Nylon Insulated with Insulation Grip Interlock Barrel



| Product Number <sup>1</sup> | UPC (054007-) | Wire Range (AWG) | Mates with Male Tab Width (W') x Thickness | L    | Barrel Length | Barrel I.D. | Maximum Insulation Diameter | Terminals per: Carton | Case |
|-----------------------------|---------------|------------------|--|------|---------------|-------------|-----------------------------|-----------------------|------|
| MNGI18-250DFX               | 09990         | 22-18            | 0.250 x 0.032                              | 0.83 | 0.25          | 0.076       | 0.145                       | 100                   | 500  |
| MNGI18-250DFK               | 69572         | 22-18            | 0.250 x 0.032                              | 0.83 | 0.25          | 0.076       | 0.145                       | —                     | 1000 |
| MNGI14-187DFX               | 09987         | 16-14            | 0.187 x 0.020                              | 0.77 | 0.25          | 0.080       | 0.145                       | 100                   | 500  |
| MNGI14-187DFK               | 69569         | 16-14            | 0.187 x 0.020                              | 0.77 | 0.25          | 0.080       | 0.145                       | —                     | 1000 |
| MNGI14-250DFX               | 09988         | 16-14            | 0.250 x 0.032                              | 0.83 | 0.25          | 0.076       | 0.145                       | 100                   | 500  |
| MNGI14-250DFK               | 69570         | 16-14            | 0.250 x 0.032                              | 0.83 | 0.25          | 0.076       | 0.145                       | —                     | 1000 |
| MNGI10-250DFX               | 09986         | 12-10            | 0.250 x 0.032                              | 0.94 | 0.25          | 0.128       | 0.250                       | 50                    | 500  |
| MNGI10-250DFK               | 69568         | 12-10            | 0.250 x 0.032                              | 0.94 | 0.25          | 0.128       | 0.250                       | —                     | 500  |

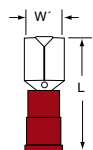

MNGI18-250DF

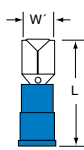

MNGI14-187DF

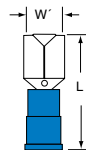

MNGI14-250DF

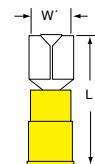

MNGI10-250DF

Wire Range

22-18

16-14

16-14

12-10

Suggested Mate

MNG18-250DM

MNG14-187DM

MNG14-250DM

MNG10-250DM

<sup>1</sup>Product number ending in X = box; product number ending with K = bulk.

### 3M™ Female Disconnects — Nylon Insulated with Insulation Grip Bullet Style

| Product Number <sup>1</sup> | UPC (051138-) | Wire Range (AWG) | Mating Snap Diameter |      | Maximum Insulation Diameter | Terminals per: |      |
|-----------------------------|---------------|------------------|----------------------|------|-----------------------------|----------------|------|
|                             |               |                  | S                    | L    |                             | Carton         | Case |
| MNG18-156DFIK-A             | 98078         | 22-18            | 0.156                | 0.99 | 0.15                        | —              | 1000 |
| MNG18-180DFIK-A             | 98084         | 22-18            | 0.180                | 1.00 | 0.15                        | —              | 1000 |
| MNG14-156DFIX-A             | 98118         | 16-14            | 0.156                | 0.99 | 0.19                        | 100            | 500  |
| MNG14-156DFIK-A             | 98117         | 16-14            | 0.156                | 0.99 | 0.19                        | —              | 1000 |
| MNG14-180DFIX-A             | 98128         | 16-14            | 0.180                | 1.00 | 0.19                        | 100            | 500  |
| MNG14-180DFIK-A             | 98127         | 16-14            | 0.180                | 1.00 | 0.19                        | —              | 1000 |

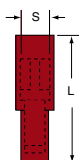

MNG18-156DFI-A

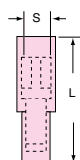

MNG18-180DFI-A

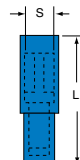

MNG14-156DFI-A

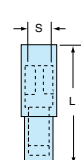

MNG14-180DFI-A

Wire Range

22-18

22-18

16-14

16-14

Suggested Mate

MNG18-156DM

MNG18-180DM

MNG14-156DM

MNG14-180DM

### 3M™ Female Disconnects — Nylon Fully Insulated Butted Seam



| Product Number <sup>1</sup> | UPC (054007-) | Wire Range (AWG)** | Mates with Male Tab Width (W') x Thickness | L    | W    | D    | Barrel Length | Barrel I.D. | Maximum Insulation Diameter | Terminals per: |      |
|-----------------------------|---------------|--------------------|--|------|------|------|---------------|-------------|-----------------------------|----------------|------|
|                             |               |                    |  |      |      |      |               |             |                             | Carton         | Case |
| MNU18-187DFIX               | 02353         | 22-18              | 0.187 x 0.020                              | 0.81 | 0.30 | 0.23 | 0.25          | 0.085       | 0.145                       | 100            | 500  |
| MNU18-187DFIK               | 02370         | 22-18              | 0.187 x 0.020                              | 0.81 | 0.30 | 0.23 | 0.25          | 0.085       | 0.145                       | —              | 1000 |
| MNU18-250DFIX               | 02286         | 22-18              | 0.250 x 0.032                              | 0.87 | 0.37 | 0.23 | 0.25          | 0.080       | 0.145                       | 100            | 500  |
| MNU18-250DFIK               | 02290         | 22-18              | 0.250 x 0.032                              | 0.87 | 0.37 | 0.23 | 0.25          | 0.080       | 0.145                       | —              | 1000 |
| MNU14-187DFIX               | 02387         | 16-14              | 0.187 x 0.020                              | 0.81 | 0.30 | 0.23 | 0.25          | 0.085       | 0.145                       | 100            | 500  |
| MNU14-187DFIK               | 02384         | 16-14              | 0.187 x 0.020                              | 0.81 | 0.30 | 0.23 | 0.25          | 0.085       | 0.145                       | —              | 1000 |
| MNU14-250DFIX               | 02287         | 16-14              | 0.250 x 0.032                              | 0.87 | 0.37 | 0.23 | 0.25          | 0.080       | 0.145                       | 50             | 500  |
| MNU14-250DFIK               | 02291         | 16-14              | 0.250 x 0.032                              | 0.87 | 0.37 | 0.23 | 0.25          | 0.080       | 0.145                       | —              | 1000 |

Not UL Listed or CSA Certified

\*\*For #10-12 AWG, see MNI10-250DFI

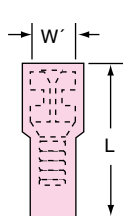
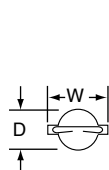

MNU18-187DFI

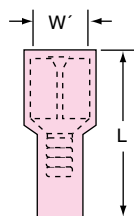

MNU18-250DFI

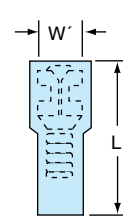

MNU14-187DFI

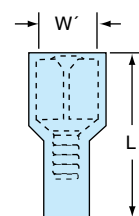

MNU14-250DFI

Stud Size

MNU18-187DFI

MNU18-250DFI

MNU14-187DFI

MNU14-250DFI

Wire Range

22-18

22-18

16-14

16-14

Suggested Mate

MNU18-187DMI

MNU18-250DMI

MNU14-187DMI

MNU14-250DMI

<sup>1</sup>Product number ending in X = box; product number ending with K = bulk.

## 3M™ Female Disconnects — Nylon Fully Insulated with Insulation Grip



| Product Number <sup>1</sup> | UPC (054007-) | Wire Range (AWG) | Mates with Male Tab Width (W') x Thickness | L    | W    | D    | Barrel Length | Barrel I.D. | Maximum Insulation Diameter | Terminals per: Carton | Case |
|-----------------------------|---------------|------------------|--|------|------|------|---------------|-------------|-----------------------------|-----------------------|------|
| MNG18-187DFIX               | 11704         | 22-18            | 0.187 x 0.020                              | 0.81 | 0.30 | 0.23 | 0.25          | 0.085       | 0.145                       | 100                   | 500  |
| MNG18-187DFIK               | 11816         | 22-18            | 0.187 x 0.020                              | 0.81 | 0.30 | 0.23 | 0.25          | 0.085       | 0.145                       | —                     | 1000 |
| MNG18-250DFIX               | 11705         | 22-18            | 0.250 x 0.032                              | 0.87 | 0.37 | 0.23 | 0.25          | 0.080       | 0.145                       | 100                   | 500  |
| MNG18-250DFIK               | 02293         | 22-18            | 0.250 x 0.032                              | 0.87 | 0.37 | 0.23 | 0.25          | 0.080       | 0.145                       | —                     | 1000 |
| MNG14-187DFIX               | 11715         | 16-14            | 0.187 x 0.020                              | 0.81 | 0.30 | 0.23 | 0.25          | 0.085       | 0.145                       | 100                   | 500  |
| MNG14-187DFIK               | 15975         | 16-14            | 0.187 x 0.020                              | 0.81 | 0.30 | 0.23 | 0.25          | 0.085       | 0.145                       | —                     | 1000 |
| MNG14-250DFIX               | 11716         | 16-14            | 0.250 x 0.032                              | 0.87 | 0.37 | 0.23 | 0.25          | 0.080       | 0.145                       | 100                   | 500  |
| MNG14-250DFIK               | 01841         | 16-14            | 0.250 x 0.032                              | 0.87 | 0.37 | 0.23 | 0.25          | 0.080       | 0.145                       | —                     | 1000 |

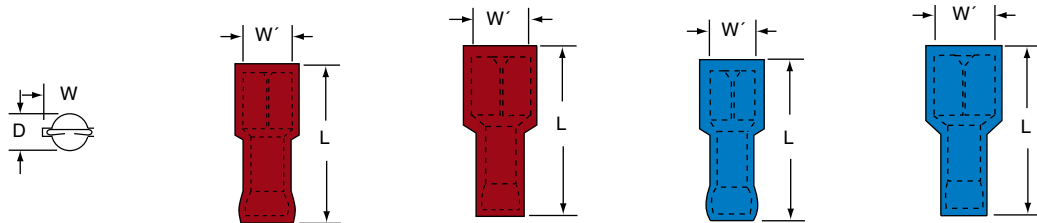

Stud Size

MNG18-187DFI

MNG18-250DFI

MNG14-187DFI

MNG14-250DFI

Wire Range

22-18

22-18

16-14

16-14

Suggested Mate

MNG18-187DMI

MNG18-250DMI

MNG14-187DMI

MNG14-250DMI

## 3M™ Female Disconnects — Nylon Fully Insulated Interlock Barrel



| Product Number <sup>1</sup> | UPC (054007-) | Wire Range (AWG) | Mates with Male Tab Width (W') x Thickness | L    | Barrel Length | Barrel I.D. | Maximum Insulation Diameter | Terminals per: Carton | Case |
|-----------------------------|---------------|------------------|--|------|---------------|-------------|-----------------------------|-----------------------|------|
| MNI18-250DFIX               | 09995         | 22-18            | 0.250 x 0.032                              | 0.91 | 0.25          | 0.076       | 0.145                       | 100                   | 500  |
| MNI18-250DFIK               | 69577         | 22-18            | 0.250 x 0.032                              | 0.91 | 0.25          | 0.076       | 0.145                       | —                     | 1000 |
| MNI14-250DFIX               | 09993         | 16-14            | 0.250 x 0.032                              | 0.91 | 0.25          | 0.076       | 0.145                       | 100                   | 500  |
| MNI14-250DFIK               | 69575         | 16-14            | 0.250 x 0.032                              | 0.91 | 0.25          | 0.076       | 0.145                       | —                     | 1000 |
| MNI10-250DFIX               | 09991         | 12-10            | 0.250 x 0.032                              | 0.99 | 0.25          | 0.128       | 0.250                       | 50                    | 500  |
| MNI10-250DFIK               | 69573         | 12-10            | 0.250 x 0.032                              | 0.99 | 0.25          | 0.128       | 0.250                       | —                     | 500  |

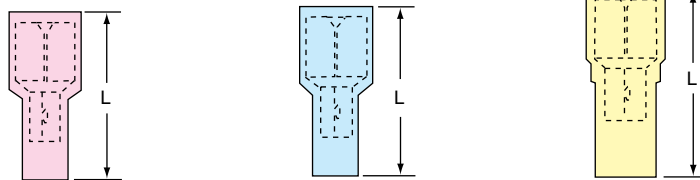

MNI18-250DFI

MNI14-250DFI

MNI10-250DFI

Wire Range

22-18

16-14

12-10

Suggested Mate

MNI18-250DMI

MNI14-250DMI

MNI10-250DMI

<sup>1</sup>Product number ending in X = box; product number ending with K = bulk.



## 3M™ Female Disconnects — Nylon Fully Insulated with Insulation Grip Interlock Barrel



| Product Number* | UPC (054007-) | Wire Range (AWG) | Mates with Male Tab Width (W') x Thickness | L    | Barrel Length | Barrel I.D. | Maximum Insulation Diameter | Terminals per: Carton | Case |
|-----------------|---------------|------------------|--|------|---------------|-------------|-----------------------------|-----------------------|------|
| MNGI18-250DFIX  | 09985         | 22-18            | 0.250 x 0.032                              | 0.87 | 0.25          | 0.076       | 0.145                       | 100                   | 500  |
| MNGI18-250DFIK  | 69567         | 22-18            | 0.250 x 0.032                              | 0.87 | 0.25          | 0.076       | 0.145                       | —                     | 1000 |
| MNGI14-250DFIX  | 09983         | 16-14            | 0.250 x 0.032                              | 0.87 | 0.25          | 0.076       | 0.145                       | 100                   | 500  |
| MNGI14-250DFIK  | 69565         | 16-14            | 0.250 x 0.032                              | 0.87 | 0.25          | 0.076       | 0.145                       | —                     | 1000 |
| MNGI10-250DFIX  | 09981         | 12-10            | 0.250 x 0.032                              | 0.99 | 0.25          | 0.128       | 0.250                       | 50                    | 500  |
| MNGI10-250DFIK  | 69563         | 12-10            | 0.250 x 0.032                              | 0.99 | 0.25          | 0.128       | 0.250                       | —                     | 500  |

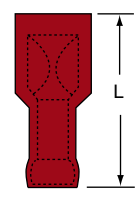

MNGI18-250DFI  
Wire Range 22-18  
Suggested Mate MNG18-250DMI

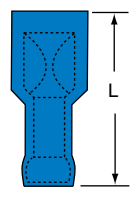

MNGI14-250DFI  
Wire Range 16-14  
Suggested Mate MNG14-250DMI

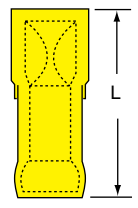

MNGI10-250DFI  
Wire Range 12-10  
Suggested Mate MNG10-250DMI

## 3M™ Female Disconnects — T-Tap Nylon Insulated Self-Stripping



| Product Number* | UPC (054007-) | Wire Range (AWG) | Mates with Male Tab Width (W') x Thickness | L    | M    | W    | Maximum Insulation Diameter | Terminals per: Carton | Case |
|-----------------|---------------|------------------|--|------|------|------|-----------------------------|-----------------------|------|
| 951X            | 12312         | 22-18            | 0.250 x 0.032                              | 0.73 | 0.44 | 0.38 | 0.150                       | 50                    | 500  |
| 951K            | 12313         | 22-18            | 0.250 x 0.032                              | 0.73 | 0.44 | 0.38 | 0.150                       | —                     | 1000 |
| 952X            | 08427         | 16-14            | 0.250 x 0.032                              | 0.73 | 0.44 | 0.38 | 0.150                       | 50                    | 500  |
| 952K            | 08428         | 16-14            | 0.250 x 0.032                              | 0.73 | 0.44 | 0.38 | 0.150                       | —                     | 1000 |
| 953X            | 12314         | 12               | 0.250 x 0.032                              | 0.73 | 0.44 | 0.38 | 0.150                       | 50                    | 500  |
| 953K            | 12315         | 12               | 0.250 x 0.032                              | 0.73 | 0.44 | 0.38 | 0.150                       | —                     | 1000 |



951  
Wire Range 22-18  
Suggested Mate MNG18-250DMI



952  
Wire Range 18-16-14  
Suggested Mate MNG14-250DMI

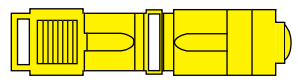

953  
Wire Range 12  
Suggested Mate MNG10-250DMI

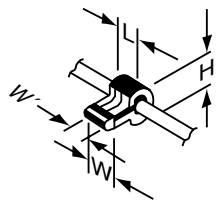

\*Product number ending in X = box; product number ending with K = bulk.

## 3M™ Female Disconnects — Heat Shrink Nylon Fully Insulated

| Product Number* | UPC (054007-) | Wire Range (AWG) | Mates with Male Tab Width (W') x Thickness | L   | W    | D    | Barrel Length | Barrel I.D. | Terminals per: Bag | Case |
|-----------------|---------------|------------------|--|-----|------|------|---------------|-------------|--------------------|------|
| MNHU18-250DFIX* | 06354         | 22-18            | 0.250 x 0.032                              | 1.2 | 0.37 | 0.23 | 0.25          | 0.080       | 25                 | 100  |
| MNHU18-250DFIK* | 06355         | 22-18            | 0.250 x 0.032                              | 1.2 | 0.37 | 0.23 | 0.25          | 0.080       | —                  | 250  |
| MNHU14-250DFIX* | 06338         | 16-14            | 0.250 x 0.032                              | 1.2 | 0.37 | 0.23 | 0.25          | 0.080       | 25                 | 100  |
| MNHU14-250DFIK* | 06339         | 16-14            | 0.250 x 0.032                              | 1.2 | 0.37 | 0.23 | 0.25          | 0.080       | —                  | 250  |
| MNHU10-250DFIX  | 06314         | 12-10            | 0.250 x 0.032                              | 1.2 | 0.39 | 0.32 | 0.25          | 0.165       | 25                 | 100  |
| MNHI10-250DFIK  | 06315         | 12-10            | 0.250 x 0.032                              | 1.2 | 0.39 | 0.32 | 0.25          | 0.165       | —                  | 250  |

\*Windowless receptacle

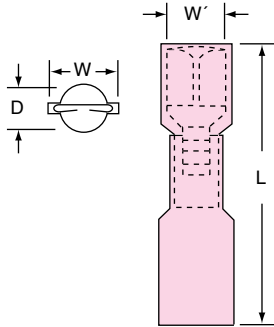

MNHU18-250DFI

Wire Range

22-18

Suggested Mate

MNHU18-250DMI

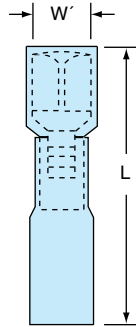

MNHU14-250DFI

16-14

MNHU14-250DMI

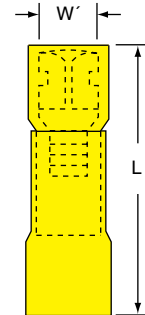

MNHI10-250DFI

12-10

MNHU10-250DMI

## 3M™ Female Disconnects — Fuseholder Polypropylene Insulated Self-Stripping

| Product Number* | UPC (054007-) | Wire Range (AWG) | Mates with Male Tab Width (W') x Thickness | L    | H    | D    | Maximum Insulation Diameter | Terminals per: Carton | Case |
|-----------------|---------------|------------------|--|------|------|------|-----------------------------|-----------------------|------|
| 972X            | 06171         | 18-14            | 0.205 x 0.025                              | 1.37 | 0.44 | 0.95 | 0.145                       | 25                    | 250  |
| 972K            | 06172         | 18-14            | 0.205 x 0.025                              | 1.37 | 0.44 | 0.95 | 0.145                       | —                     | 1000 |

For use with flat blade automotive type fuse of 30V or less.

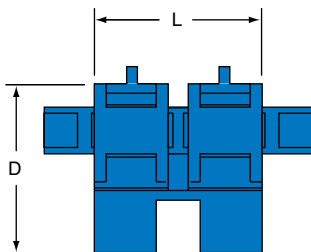

972

Wire Range

18-14

Suggested Mate

ATO Auto Fuse

\*Product number ending in X = box; product number ending with K = bulk.

# Male Disconnects

## 3M™ Male Disconnects — Non-Insulated Butted Seam



| Product Number* | UPC (054007-) | Wire Range (AWG) | Male Tab Width (W') x Thickness | L    | Barrel Length | Barrel I.D. | Terminals per: Carton | Case |
|-----------------|---------------|------------------|---------------------------------|------|---------------|-------------|-----------------------|------|
| MU18-187DMK     | 02372         | 22-18            | 0.187 x 0.020                   | 0.64 | 0.24          | 0.080       | —                     | 1000 |
| MU18-250DMK     | 02364         | 22-18            | 0.250 x 0.032                   | 0.73 | 0.25          | 0.065       | —                     | 1000 |
| MU14-187DMK     | 01783         | 16-14            | 0.187 x 0.020                   | 0.64 | 0.24          | 0.080       | —                     | 1000 |
| MU14-250DMX     | 22971         | 16-14            | 0.250 x 0.032                   | 0.73 | 0.25          | 0.085       | 100                   | 500  |
| MU14-250DMK     | 01784         | 16-14            | 0.250 x 0.032                   | 0.73 | 0.25          | 0.085       | —                     | 1000 |
| MU10-250DMX     | 23912         | 12-10            | 0.250 x 0.032                   | 0.75 | 0.25          | 0.150       | 100                   | 500  |
| MU10-250DMK     | 02056         | 12-10            | 0.250 x 0.032                   | 0.75 | 0.25          | 0.150       | —                     | 500  |

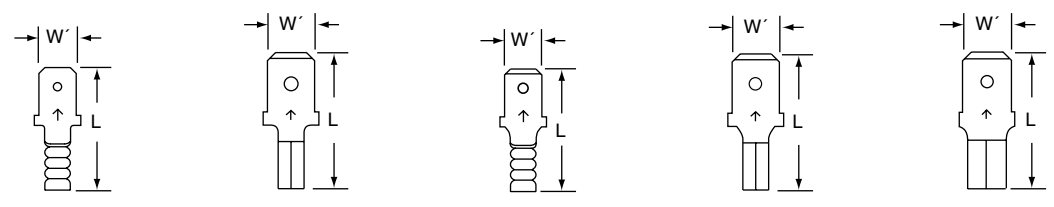

MU18-187DM      MU18-250DM      MU14-187DM      MU14-250DM      MU10-250DM

|                |            |            |            |            |            |
|----------------|------------|------------|------------|------------|------------|
| Wire Range     | 22-18      | 22-18      | 16-14      | 16-14      | 12-10      |
| Suggested Mate | MU18-187DF | MU18-250DF | MU14-187DF | MU14-250DF | MU10-250DF |

## 3M™ Male Disconnects — Vinyl Insulated Butted Seam



| Product Number* | UPC (054007-) | Wire Range (AWG) | Male Tab Width (W') x Thickness | L    | Barrel Length | Barrel I.D. | Maximum Insulation Diameter | Terminals per: Carton | Case |
|-----------------|---------------|------------------|---------------------------------|------|---------------|-------------|-----------------------------|-----------------------|------|
| MVU18-187DMK    | 02375         | 22-18            | 0.187 x 0.020                   | 0.85 | 0.24          | 0.080       | 0.145                       | —                     | 1000 |
| MVU18-250DMX    | 11822         | 22-18            | 0.250 x 0.032                   | 0.93 | 0.25          | 0.065       | 0.145                       | 100                   | 500  |
| MVU18-250DMK    | 02376         | 22-18            | 0.250 x 0.032                   | 0.93 | 0.25          | 0.065       | 0.145                       | —                     | 1000 |
| MVU14-187DMX    | 22989         | 16-14            | 0.187 x 0.020                   | 0.85 | 0.24          | 0.080       | 0.145                       | 100                   | 500  |
| MVU14-187DMK    | 01789         | 16-14            | 0.187 x 0.020                   | 0.85 | 0.24          | 0.080       | 0.145                       | —                     | 1000 |
| MVU14-250DMX    | 22997         | 16-14            | 0.250 x 0.032                   | 0.93 | 0.25          | 0.085       | 0.170                       | 100                   | 500  |
| MVU14-250DMK    | 01790         | 16-14            | 0.250 x 0.032                   | 0.93 | 0.25          | 0.085       | 0.170                       | —                     | 1000 |
| MVU10-250DMX    | 23920         | 12-10            | 0.250 x 0.032                   | 1.05 | 0.25          | 0.150       | 0.250                       | 50                    | 500  |
| MVU10-250DMK    | 02059         | 12-10            | 0.250 x 0.032                   | 1.05 | 0.25          | 0.150       | 0.250                       | —                     | 500  |

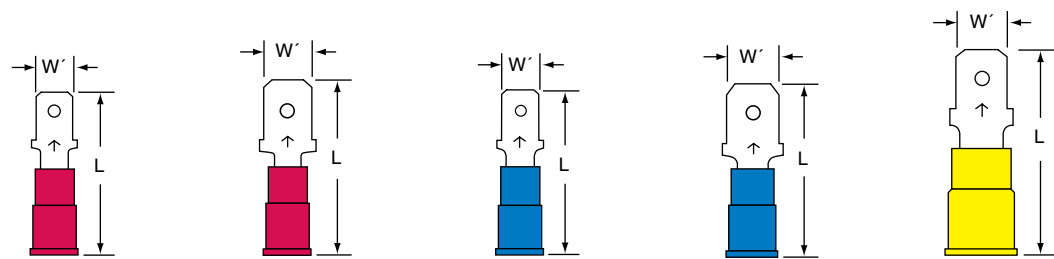

MVU18-187DM      MVU18-250DM      MVU14-187DM      MVU14-250DM      MVU10-250DM

|                |             |             |             |             |             |
|----------------|-------------|-------------|-------------|-------------|-------------|
| Wire Range     | 22-18       | 22-18       | 16-14       | 16-14       | 12-10       |
| Suggested Mate | MVU18-187DF | MVU18-250DF | MVU14-187DF | MVU14-250DF | MVU10-250DF |

\*Product number ending in X = box; product number ending with K = bulk.

## 3M™ Male Disconnects — Vinyl Insulated Butted Seam Bullet Style



| Product Number | UPC (051138-) | Wire Range (AWG) | Mating Snap Diameter |      | Maximum Insulation Diameter | Terminals per: |      |
|----------------|---------------|------------------|----------------------|------|-----------------------------|----------------|------|
|                |               |                  | S                    | L    |                             | Carton         | Case |
| MVU18-156DMK-A | 98094         | 22-18            | 0.156                | 0.85 | 0.15                        | —              | 1000 |
| MVU18-180DMK-A | 98145         | 22-18            | 0.180                | 0.83 | 0.15                        | —              | 1000 |
| MVU14-156DMX-A | 98147         | 16-14            | 0.156                | 0.85 | 0.170                       | 100            | 500  |
| MVU14-156DMK-A | 98149         | 16-14            | 0.156                | 0.85 | 0.170                       | —              | 1000 |
| MVU14-180DMX-A | 98160         | 16-14            | 0.180                | 0.83 | 0.171                       | 100            | 500  |
| MVU14-180DMK   | 98163         | 16-14            | 0.180                | 0.83 | 0.171                       | —              | 1000 |

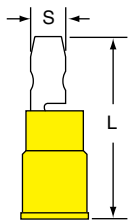

MVU18-156DM

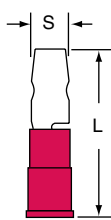

MVU18-180DM

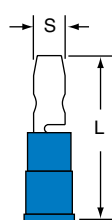

MVU14-156DM

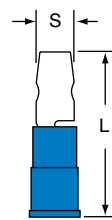

MVU14-180DM

Wire Range

22-18

22-18

16-14

16-14

Suggested Mate

MNU18-156DFI

MNU18-180DFI

MNU14-156DFI

MNU14-180DFI

## 3M™ Male Disconnects — Nylon Insulated with Insulation Grip



| Product Number | UPC (054007-) | Wire Range (AWG) | Male Tab Width (W') x Thickness | L    | Barrel Length | Barrel I.D. | Maximum Insulation Diameter | Terminals per: |      |
|----------------|---------------|------------------|---------------------------------|------|---------------|-------------|-----------------------------|----------------|------|
|                |               |                  |                                 |      |               |             |                             | Carton         | Case |
| MNG18-187DMK   | 02377         | 22-18            | 0.187 x 0.020                   | 0.84 | 0.24          | 0.080       | 0.145                       | —              | 1000 |
| MNG18-250DMX   | 02365         | 22-18            | 0.250 x 0.032                   | 0.92 | 0.25          | 0.065       | 0.145                       | 100            | 500  |
| MNG18-250DMK   | 02378         | 22-18            | 0.250 x 0.032                   | 0.92 | 0.25          | 0.065       | 0.145                       | —              | 1000 |
| MNG14-187DMX   | 23003         | 16-14            | 0.187 x 0.020                   | 0.84 | 0.24          | 0.080       | 0.145                       | 100            | 500  |
| MNG14-187DMK   | 01787         | 16-14            | 0.187 x 0.020                   | 0.84 | 0.24          | 0.080       | 0.145                       | —              | 1000 |
| MNG14-250DMX   | 23011         | 16-14            | 0.250 x 0.032                   | 0.94 | 0.25          | 0.085       | 0.170                       | 100            | 500  |
| MNG14-250DMK   | 01788         | 16-14            | 0.250 x 0.032                   | 0.94 | 0.25          | 0.085       | 0.170                       | —              | 1000 |
| MNG10-250DMX   | 23938         | 12-10            | 0.250 x 0.032                   | 1.05 | 0.25          | 0.150       | 0.250                       | 50             | 500  |
| MNG10-250DMK   | 02058         | 12-10            | 0.250 x 0.032                   | 1.05 | 0.25          | 0.150       | 0.250                       | —              | 500  |

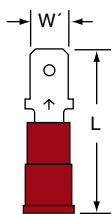

MNG18-187DM

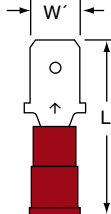

MNG18-250DM

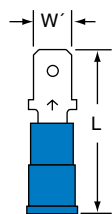

MNG14-187DM

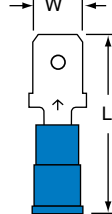

MNG14-250DM

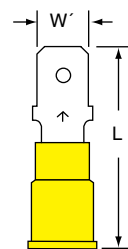

MNG10-250DM

Wire Range

22-18

22-18

16-14

16-14

12-10

Suggested Mate

MNG18-187DF

MNG18-250DF

MNG14-187DF

MNG14-250DF

MNG10-250DF

\*Product number ending in X = box; product number ending with K = bulk.

### 3M™ Male Disconnects — Nylon Insulated with Insulation Grip Bullet Style



| Product Number <sup>1</sup> | UPC (051138-) | Wire Range (AWG) | Mating Snap Diameter |      | Maximum Insulation Diameter | Terminals per: |      |
|-----------------------------|---------------|------------------|----------------------|------|-----------------------------|----------------|------|
|                             |               |                  | S                    | L    |                             | Carton         | Case |
| MNG18-156DMK-A              | 98088         | 22-18            | 0.156                | 0.87 | 0.15                        | —              | 1000 |
| MNG18-180DMK-A              | 98100         | 22-18            | 0.180                | 0.87 | 0.15                        | —              | 1000 |
| MNG14-156DMX-A              | 98139         | 16-14            | 0.156                | 0.87 | 0.19                        | 100            | 500  |
| MNG14-156DMK-A              | 98137         | 16-14            | 0.156                | 0.87 | 0.19                        | —              | 1000 |
| MNG14-180DMK-A              | 98155         | 16-14            | 0.180                | 0.87 | 0.19                        | —              | 1000 |

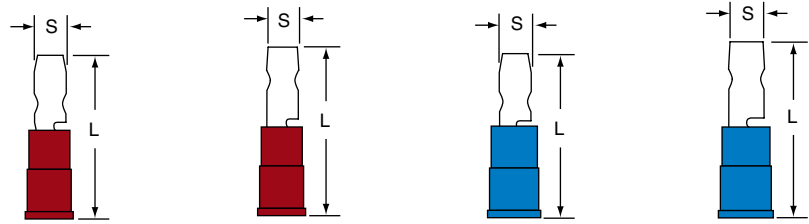

|                |               |               |               |               |
|----------------|---------------|---------------|---------------|---------------|
|                | MNG18-156DM-A | MNG18-180DM-A | MNG14-156DM-A | MNG14-180DM-A |
| Wire Range     | 22-18         | 22-18         | 16-14         | 16-14         |
| Suggested Mate | MNG18-156DFI  | MNG18-180DFI  | MNG14-156DFI  | MNG14-180DFI  |

### 3M™ Male Disconnects — Nylon Fully Insulated Butted Seam



| Product Number <sup>1</sup> | UPC (054007-) | Wire Range (AWG) | Male Tab Width (W') x Thickness | L    | W    | D    | Barrel Length | Barrel I.D. | Maximum Insulation Diameter | Terminals per: |      |
|-----------------------------|---------------|------------------|---------------------------------|------|------|------|---------------|-------------|-----------------------------|----------------|------|
|                             |               |                  |                                 |      |      |      |               |             |                             | Carton         | Case |
| MNU18-187DMIX               | 02354         | 22-18            | 0.187 x 0.020                   | 0.87 | 0.37 | 0.30 | 0.24          | 0.080       | 0.145                       | 100            | 500  |
| MNU18-187DMIK               | 02379         | 22-18            | 0.187 x 0.020                   | 0.87 | 0.37 | 0.30 | 0.24          | 0.080       | 0.145                       | —              | 1000 |
| MNU18-250DMIX               | 02289         | 22-18            | 0.250 x 0.032                   | 0.95 | 0.44 | 0.30 | 0.25          | 0.065       | 0.145                       | 100            | 500  |
| MNU18-250DMIK               | 02299         | 22-18            | 0.250 x 0.032                   | 0.95 | 0.44 | 0.30 | 0.25          | 0.065       | 0.145                       | —              | 1000 |
| MNU14-187DMIX               | 02381         | 16-14            | 0.187 x 0.020                   | 0.87 | 0.37 | 0.30 | 0.24          | 0.080       | 0.145                       | 100            | 500  |
| MNU14-187DMIK               | 02385         | 16-14            | 0.187 x 0.020                   | 0.87 | 0.37 | 0.30 | 0.24          | 0.080       | 0.145                       | —              | 1000 |
| MNU14-250DMIX               | 02306         | 16-14            | 0.250 x 0.032                   | 0.95 | 0.44 | 0.30 | 0.25          | 0.085       | 0.170                       | 50             | 500  |
| MNU14-250DMIK               | 02300         | 16-14            | 0.250 x 0.032                   | 0.95 | 0.44 | 0.30 | 0.25          | 0.085       | 0.170                       | —              | 1000 |
| MNU10-250DMIX               | 02307         | 12-10            | 0.250 x 0.032                   | 1.05 | 0.47 | 0.39 | 0.25          | 0.150       | 0.250                       | 50             | 500  |
| MNU10-250DMIK               | 02301         | 12-10            | 0.250 x 0.032                   | 1.05 | 0.47 | 0.39 | 0.25          | 0.150       | 0.250                       | —              | 500  |

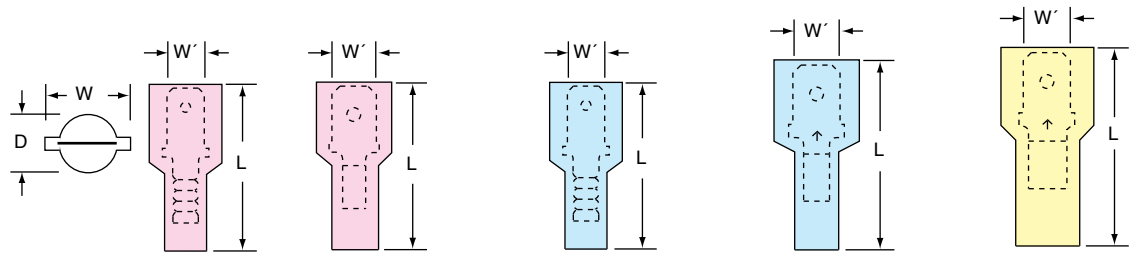

|                |              |              |              |              |              |
|----------------|--------------|--------------|--------------|--------------|--------------|
|                | MNU18-187DMI | MNU18-250DMI | MNU14-187DMI | MNU14-250DMI | MNU10-250DMI |
| Wire Range     | 22-18        | 22-18        | 16-14        | 16-14        | 12-10        |
| Suggested Mate | MNU18-187DFI | MNU18-250DFI | MNU14-187DFI | MNU14-250DFI | MNU10-250DFI |

<sup>1</sup>Product number ending in X = box; product number ending with K = bulk.

## 3M™ Male Disconnects — Nylon Fully Insulated with Insulation Grip



| Product Number | UPC (054007-) | Wire Range (AWG) | Male Tab Width (W') x Thickness | L    | W    | D    | Barrel Length | Barrel I.D. | Maximum Insulation Diameter | Terminals per: Carton | Case |
|----------------|---------------|------------------|---------------------------------|------|------|------|---------------|-------------|-----------------------------|-----------------------|------|
| MNG18-187DMIX  | 11710         | 22-18            | 0.187 x 0.020                   | 0.87 | 0.37 | 0.30 | 0.24          | 0.080       | 0.145                       | 100                   | 500  |
| MNG18-187DMIK  | 11794         | 22-18            | 0.187 x 0.020                   | 0.87 | 0.37 | 0.30 | 0.24          | 0.080       | 0.145                       | —                     | 1000 |
| MNG18-250DMIX  | 11711         | 22-18            | 0.250 x 0.032                   | 0.95 | 0.44 | 0.30 | 0.25          | 0.065       | 0.145                       | 100                   | 500  |
| MNG18-250DMIK  | 02302         | 22-18            | 0.250 x 0.032                   | 0.95 | 0.44 | 0.30 | 0.25          | 0.065       | 0.145                       | —                     | 1000 |
| MNG14-187DMIX  | 11722         | 16-14            | 0.187 x 0.020                   | 0.87 | 0.37 | 0.30 | 0.24          | 0.080       | 0.145                       | 100                   | 500  |
| MNG14-187DMIK  | 02386         | 16-14            | 0.187 x 0.020                   | 0.87 | 0.37 | 0.30 | 0.24          | 0.080       | 0.145                       | —                     | 1000 |
| MNG14-250DMIX  | 11723         | 16-14            | 0.250 x 0.032                   | 0.95 | 0.44 | 0.30 | 0.25          | 0.085       | 0.170                       | 100                   | 500  |
| MNG14-250DMIK  | 02249         | 16-14            | 0.250 x 0.032                   | 0.95 | 0.44 | 0.30 | 0.25          | 0.085       | 0.170                       | —                     | 1000 |
| MNG10-250DMIX  | 11729         | 12-10            | 0.250 x 0.032                   | 1.05 | 0.47 | 0.39 | 0.25          | 0.150       | 0.250                       | 50                    | 500  |
| MNG10-250DMIK  | 02303         | 12-10            | 0.250 x 0.032                   | 1.05 | 0.47 | 0.39 | 0.25          | 0.150       | 0.250                       | —                     | 500  |

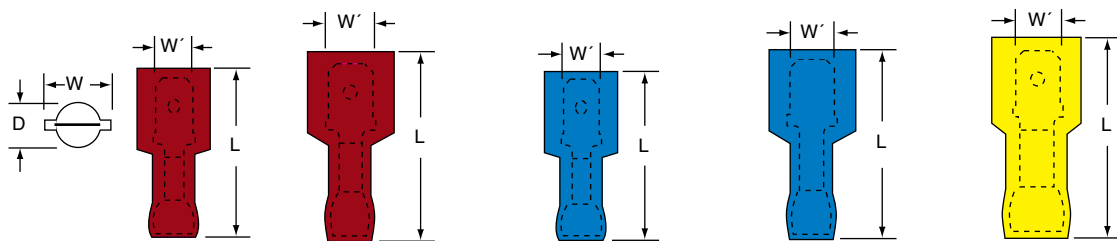

MNG18-187DMI

MNG18-250DMI

MNG14-187DMI

MNG14-250DMI

MNG10-250DMI

Wire Range

22-18

22-18

16-14

16-14

12-10

Suggested Mate

MNG18-187DFI

MNG18-250DFI

MNG14-187DFI

MNG14-250DFI

MNG10-250DFI

## 3M™ Male Disconnects — Heat Shrink Nylon Fully Insulated Butted Seam

| Product Number | UPC (054007-) | Wire Range (AWG) | Male Tab Width (W') x Thickness | L   | W    | D    | Barrel Length | Barrel I.D. | Terminals per: Carton | Case |
|----------------|---------------|------------------|---------------------------------|-----|------|------|---------------|-------------|-----------------------|------|
| MNHU18-250DMIX | 06356         | 22-18            | 0.250 x 0.032                   | 1.2 | 0.44 | 0.30 | 0.25          | 0.065       | 25                    | 100  |
| MNHU18-250DMIK | 06357         | 22-18            | 0.250 x 0.032                   | 1.2 | 0.44 | 0.30 | 0.25          | 0.065       | —                     | 250  |
| MNHU14-250DMIX | 06340         | 16-14            | 0.250 x 0.032                   | 1.2 | 0.44 | 0.30 | 0.25          | 0.085       | 25                    | 100  |
| MNHU14-250DMIK | 06341         | 16-14            | 0.250 x 0.032                   | 1.2 | 0.44 | 0.30 | 0.25          | 0.085       | —                     | 250  |
| MNHU10-250DMIX | 06316         | 12-10            | 0.250 x 0.032                   | 1.2 | 0.47 | 0.39 | 0.25          | 0.150       | 25                    | 100  |
| MNHU10-250DMIK | 06317         | 12-10            | 0.250 x 0.032                   | 1.2 | 0.47 | 0.39 | 0.25          | 0.150       | —                     | 250  |

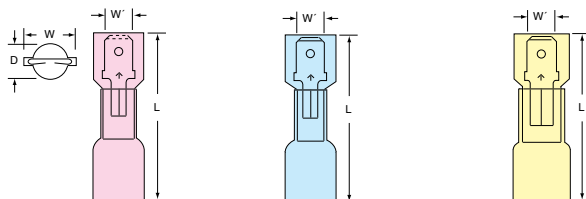

MNHU18-250DMI

MNHU14-250DMI

MNHU10-250DMI

Wire Range

22-18

16-14

12-10

Suggested Mate

MNHU18-250DFI

MNHU14-250DFI

MNHI10-250DFI

Product number ending in X = box; product number ending with K = bulk.

# Flags and Multi-Stack Disconnects

## 3M™ Flags — Non-Insulated Ring Type



| Product Number* | UPC (054007-) | Wire Range (AWG) | Stud Size | W    | C    | L    | Thickness | Barrel Length | Barrel I.D. | Terminals per Case |
|-----------------|---------------|------------------|-----------|------|------|------|-----------|---------------|-------------|--------------------|
| MU18-6R/FLAGK   | 01294         | 22-18            | 6         | 0.38 | 0.34 | 0.66 | 0.030     | 0.26          | 0.070       | 1000               |

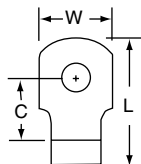

MU18-6R/FLAG

Stud Size                    6  
 Wire Range                 22-18

## 3M™ Multi-Stack Disconnects — Vinyl Insulated Butted Seam

| Product Number* | UPC (051138-) | Wire Range (AWG) | Mates with Female & Male Width (W') x Thickness | L    | Maximum Insulation Diameter | Terminals per Carton | Case |
|-----------------|---------------|------------------|---|------|-----------------------------|----------------------|------|
| MVU18-250DMFX-A | 98063         | 22-18            | 0.250 x 0.032                                   | 0.87 | 0.145                       | 100                  | 500  |
| MVU18-250DMFK-A | 98062         | 22-18            | 0.250 x 0.032                                   | 0.87 | 0.145                       | —                    | 1000 |
| MVU14-250DMFX-A | 98074         | 16-14            | 0.250 x 0.032                                   | 0.87 | 0.170                       | 100                  | 500  |
| MVU14-250DMFK-A | 98073         | 16-14            | 0.250 x 0.032                                   | 0.87 | 0.170                       | —                    | 1000 |

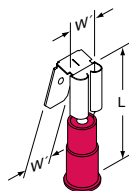

MVU18-250DMF-A

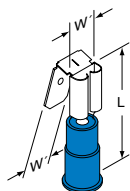

MVU14-250DMF-A

Wire Range                    22-18                    16-14  
 Suggested Mate            0.250 Male/Female    0.250 Male/Female

\*Product number ending in X = box; product number ending with K = bulk.

## 3M™ Multi-Stack Disconnects — Vinyl Insulated Butted Seam

| Product Number <sup>†</sup> | UPC<br>(051138-) | Wire Range<br>(AWG) | Mates with Female & Male<br>Width (W') x Thickness | L    | Maximum<br>Insulation<br>Diameter | Terminals per<br>Case |
|-----------------------------|------------------|---------------------|--|------|-----------------------------------|-----------------------|
| MNG18-250DMFX-A             | 98059            | 22-18               | 0.250 x 0.032                                      | 0.86 | 0.145                             | 1000                  |
| MNG18-250DMFK-A             | 98058            | 22-18               | 0.250 x 0.032                                      | 0.86 | 0.145                             | 1000                  |
| MNG14-250DMFX-A             | 98068            | 16-14               | 0.250 x 0.032                                      | 0.88 | 0.170                             | 1000                  |
| MNG14-250DMFK-A             | 98067            | 16-14               | 0.250 x 0.032                                      | 0.88 | 0.170                             | 1000                  |

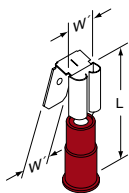

MNG18-250DMF-A

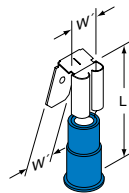

MNG14-250DMF-A

Wire Range

22-18

16-14

Suggested Mate

0.250 Male/Female

0.250 Male/Female

## Adapters

### 3M™ Adapters — Non-Insulated Double Male-Female



| Product Number <sup>†</sup> | UPC<br>(054007-) | Mates with Female & Male<br>Width (W') x Thickness | L    | Terminals per:<br>Carton | Case |
|-----------------------------|------------------|--|------|--------------------------|------|
| MA250DMFMX-A*               | 57452**          | 0.250 x 0.032                                      | 0.78 | 50                       | 500  |
| MA250DMFMK-A*               | 57451**          | 0.250 x 0.032                                      | 0.78 | —                        | 500  |
| MA250DMMFX                  | 02308            | 0.250 x 0.032                                      | 0.76 | 50                       | 500  |
| MA250DMMFK                  | 02273            | 0.250 x 0.032                                      | 0.76 | —                        | 500  |

\* Not UL Listed or CSA Certified

\*\* UPC prefix 051128-

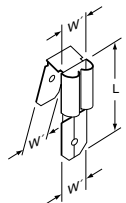

MA250DMFM-A

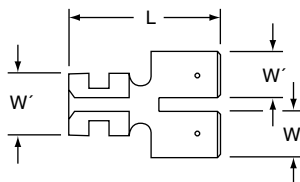

MA250DMMF

Suggested Mate

0.250 Males (2)/Female

0.250 Males (2)/Female

Suggested Mate

0.250 Male/Female

0.250 Male/Female

<sup>†</sup>Product number ending in X = box; product number ending with K = bulk.



### 3M™ Adapters — Non-Insulated Male Fuse-Clip

| Product Number* | UPC (054007-) | Male Tab Width (W') x Thickness | L    | Terminals per Case |
|-----------------|---------------|---------------------------------|------|--------------------|
| MA250DM/FUSEK   | 02269         | 0.250 x 0.030                   | 0.77 | 500                |

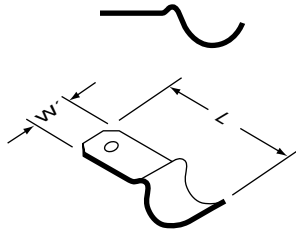

MA250DM/FUSE

Suggested Mate                    0.250 Female/Fuse  
 Suggested Mate                    0.250 Male/Female

### 3M™ Adapters — Non-Insulated Male Rectangular Tongue

| Product Number* | UPC (054007-) | Stud Size | Male Tab Width (W') x Thickness | W    | C    | L    | Terminals per Case |
|-----------------|---------------|-----------|---------------------------------|------|------|------|--------------------|
| MA250DM/6RRK    | 02225         | 6         | 0.250 x 0.032                   | 0.30 | 0.26 | 0.80 | 500                |
| MA250DM/8RRK    | 02226         | 8         | 0.250 x 0.032                   | 0.30 | 0.26 | 0.80 | 500                |
| MA250DM/10RRK   | 02227         | 10        | 0.250 x 0.032                   | 0.30 | 0.26 | 0.80 | 500                |

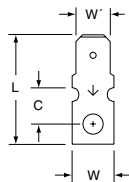

MA250DM/6RR

Suggested Mate                    0.250 Female Disconnect

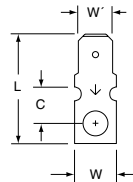

MA250DM/8RR

Suggested Mate                    0.250 Female Disconnect

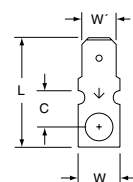

MA250DM/10RR

Suggested Mate                    0.250 Female Disconnect

### 3M™ Adapters — Vinyl Insulated Double Female Disconnect

| Product Number* | UPC (054007-) | Male Tab Width (W') x Thickness | L    | Terminals per Case |
|-----------------|---------------|---------------------------------|------|--------------------|
| MVA156DFFIK     | 14358         | 0.156                           | 1.31 | 500                |
| MVA180DFFIK     | 02236         | 0.180                           | 1.31 | 500                |

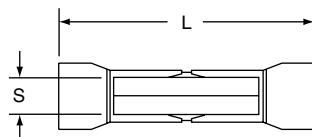

MVA156DFFI

Suggested Mate                    0.156 Male Bullets  
 Suggested Mate                    0.250 Male/Female

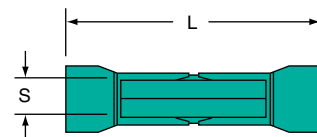

MVA180DFFI

Suggested Mate                    0.180 Male Bullets  
 Suggested Mate                    0.250 Male/Female

\*Product number ending in X = box; product number ending with K = bulk.

# High Temperature

## 3M™ High Temperature Ring Tongues\* — Butted Seam 900°F (482°C)

| Product Number <sup>1</sup> | UPC (054007-) | Wire Range (AWG) | Stud Size | W    | C    | L    | E    | Thickness | Barrel Length | Barrel I.D. | Terminals per: Carton | Case |
|-----------------------------|---------------|------------------|-----------|------|------|------|------|-----------|---------------|-------------|-----------------------|------|
| MU18-6RHT/SX                | 49607         | 22-18            | 6         | 0.25 | 0.22 | 0.60 | 0.47 | 0.030     | 0.25          | 0.070       | 100                   | 500  |
| MU18-6RHT/SK                | 01297         | 22-18            | 6         | 0.25 | 0.22 | 0.60 | 0.47 | 0.030     | 0.25          | 0.070       | —                     | 1000 |
| MU18-10RHTX                 | 49608         | 22-18            | 10        | 0.33 | 0.29 | 0.70 | 0.54 | 0.030     | 0.25          | 0.070       | 100                   | 500  |
| MU18-10RHTK                 | 01155         | 22-18            | 10        | 0.33 | 0.29 | 0.70 | 0.54 | 0.030     | 0.25          | 0.070       | —                     | 1000 |
| MU14-6RHT/SX                | 49629         | 16-14            | 6         | 0.25 | 0.22 | 0.60 | 0.47 | 0.030     | 0.25          | 0.090       | 100                   | 500  |
| MU14-6RHT/SK                | 01758         | 16-14            | 6         | 0.25 | 0.22 | 0.60 | 0.47 | 0.030     | 0.25          | 0.090       | —                     | 1000 |
| MU14-10RHTX                 | 15629         | 16-14            | 10        | 0.33 | 0.29 | 0.70 | 0.54 | 0.030     | 0.25          | 0.090       | 100                   | 500  |
| MU14-10RHTK                 | 01759         | 16-14            | 10        | 0.33 | 0.29 | 0.70 | 0.54 | 0.030     | 0.25          | 0.090       | —                     | 1000 |
| MU14-14RHTX                 | 49630         | 16-14            | 1/4       | 0.56 | 0.40 | 0.93 | 0.65 | 0.030     | 0.25          | 0.090       | 100                   | 500  |
| MU14-14RHTK                 | 01760         | 16-14            | 1/4       | 0.56 | 0.40 | 0.93 | 0.65 | 0.030     | 0.25          | 0.090       | —                     | 1000 |
| MU10-10RHTX                 | 15637         | 12-10            | 10        | 0.38 | 0.29 | 0.73 | 0.54 | 0.040     | 0.25          | 0.135       | 50                    | 500  |
| MU10-10RHTK                 | 02045         | 12-10            | 10        | 0.38 | 0.29 | 0.73 | 0.54 | 0.040     | 0.25          | 0.135       | —                     | 500  |
| MU10-14RHTK                 | 02046         | 12-10            | 1/4       | 0.59 | 0.44 | 0.99 | 0.69 | 0.040     | 0.25          | 0.135       | —                     | 500  |
| MU8-14RHT/SK                | 02142         | 8                | 1/4       | 0.47 | 0.40 | 0.95 | 0.71 | 0.050     | 0.31          | 0.185       | —                     | 200  |
| MU6-38RHTK                  | 02171         | 6                | 3/8       | 0.63 | 0.52 | 1.22 | 0.91 | 0.050     | 0.39          | 0.255       | —                     | 200  |
| MU4-38RHTK                  | 02196         | 4                | 3/8       | 0.68 | 0.53 | 1.34 | 1.00 | 0.075     | 0.47          | 0.285       | —                     | 200  |

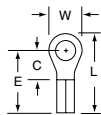

MU18-6RHT/S

Stud Size  
Wire Range

6  
22-18

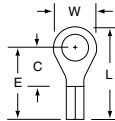

MU18-10RHT

10  
22-18

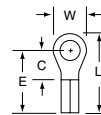

MU14-6RHT/S

6  
16-14

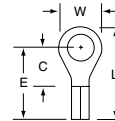

MU14-10RHT

10  
16-14

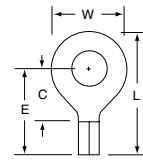

MU14-14RHT

1/4  
16-14

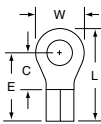

MU10-10RHT

Stud Size  
Wire Range

10  
12-10

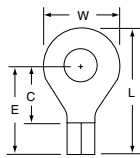

MU10-14RHT

1/4  
12-10

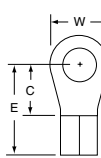

MU8-14RHT/S

1/4  
8

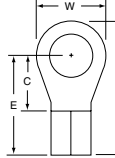

MU6-38RHT

3/8  
6

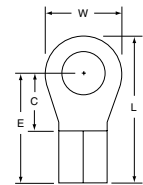

MU4-38RHT

3/8  
4

\*Steel with nickel plating

<sup>1</sup>Product number ending in X = box; product number ending with K = bulk.

### 3M™ High Temperature Standard Forks\* — Butted Seam 900°F (482°C)

| Product Number <sup>†</sup> | UPC (054007-) | Wire Range (AWG) | Stud Size | W    | C    | L    | E    | Thickness | Barrel Length | Barrel I.D. | Terminals per Case |
|-----------------------------|---------------|------------------|-----------|------|------|------|------|-----------|---------------|-------------|--------------------|
| MU18-10FHTK                 | 01333         | 22-18            | 10        | 0.34 | 0.29 | 0.70 | 0.54 | 0.030     | 0.25          | 0.070       | 1000               |
| MU14-10FHTK                 | 01842         | 16-14            | 10        | 0.34 | 0.29 | 0.70 | 0.54 | 0.030     | 0.25          | 0.090       | 1000               |
| MU10-10FHTK                 | 02095         | 12-10            | 10        | 0.38 | 0.28 | 0.73 | 0.53 | 0.040     | 0.25          | 0.135       | 500                |

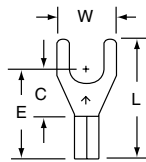

MU18-10FHT

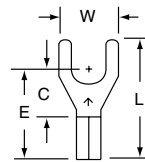

MU14-10FHT

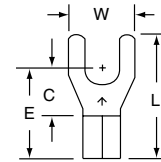

MU10-10FHT

Stud Size

10

10

10

Wire Range

22-18

16-14

12-10

### 3M™ High Temperature Block Forks\* — Butted Seam 900°F (482°C)

| Product Number <sup>†</sup> | UPC (054007-) | Wire Range (AWG) | Stud Size | W    | C    | L    | E    | Thickness | Barrel Length | Barrel I.D. | Terminals per Case |
|-----------------------------|---------------|------------------|-----------|------|------|------|------|-----------|---------------|-------------|--------------------|
| MU18-6FBHTK                 | 01334         | 22-18            | 6         | 0.30 | 0.25 | 0.65 | 0.50 | 0.030     | 0.25          | 0.070       | 1000               |
| MU14-6FBHTK                 | 01843         | 16-14            | 6         | 0.30 | 0.25 | 0.65 | 0.50 | 0.030     | 0.25          | 0.090       | 1000               |

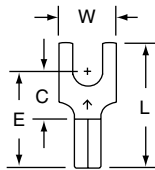

MU18-6FBHT

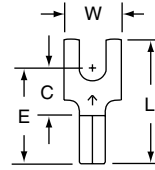

MU14-6FBHT

Stud Size

6

6

Wire Range

22-18

16-14

### 3M™ High Temperature Butt Connectors\* — Butted Seam 900°F (482°C)

| Product Number <sup>†</sup> | UPC (054007-) | Wire Range (AWG) | L    | Thickness | Barrel Length | Barrel I.D. | Terminals per Carton | Case |
|-----------------------------|---------------|------------------|------|-----------|---------------|-------------|----------------------|------|
| MU18BCHTX                   | 49609         | 22-18            | 0.56 | 0.030     | 0.25          | 0.070       | 100                  | 500  |
| MU18BCHTK                   | 01299         | 22-18            | 0.56 | 0.030     | 0.25          | 0.070       | —                    | 1000 |
| MU14BCHTX                   | 49631         | 16-14            | 0.56 | 0.030     | 0.25          | 0.090       | 100                  | 500  |
| MU14BCHTK                   | 01761         | 16-14            | 0.56 | 0.030     | 0.25          | 0.090       | —                    | 1000 |
| MU10BCHTX                   | 49645         | 12-10            | 0.56 | 0.040     | 0.25          | 0.135       | 50                   | 500  |
| MU10BCHTK                   | 02232         | 12-10            | 0.56 | 0.040     | 0.25          | 0.135       | —                    | 500  |

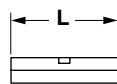

MU18BCHT

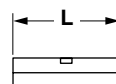

MU14BCHT

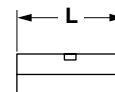

MU10BCHT

Wire Range

22-18

16-14

12-10

\*Steel with nickel plating

<sup>†</sup>Product number ending in X = box; product number ending with K = bulk.

### 3M™ High Temperature Female Disconnects\* — Butted Seam 900°F (482°C)

| Product Number <sup>†</sup> | UPC (054007-) | Wire Range (AWG) | Mates with Male Tab Width (W') x Thickness | L    | Barrel Length | Barrel I.D. | Terminals per: Carton | Case |
|-----------------------------|---------------|------------------|--|------|---------------|-------------|-----------------------|------|
| MU14-187DFHTK               | 01762         | 16-14            | 0.187 x 0.020                              | 0.58 | 0.25          | 0.085       | —                     | 1000 |
| MU14-250DFHTX               | 49632         | 16-14            | 0.250 x 0.032                              | 0.64 | 0.23          | 0.095       | 100                   | 500  |
| MU14-250DFHTK               | 01763         | 16-14            | 0.250 x 0.032                              | 0.64 | 0.23          | 0.095       | —                     | 1000 |

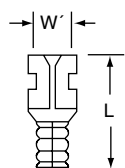

MU14-187DFHT

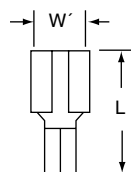

MU14-250DFHT

Wire Range

16-14

16-14

Suggested Mate

0.187 High Temperature Male Tab

MU14-250DMHT

### 3M™ High Temperature Female Disconnects\* — Butted Seam Flag 900°F (482°C)

| Product Number <sup>†</sup> | UPC (054007-) | Wire Range (AWG) | Mates with Male Tab Width (W') x Thickness | L    | Barrel Length | Barrel I.D. | Terminals per Case |
|-----------------------------|---------------|------------------|--|------|---------------|-------------|--------------------|
| MU14-250DFHT/FLAGK          | 01839         | 16-14            | 0.250 x 0.032                              | 0.51 | 0.26          | 0.095       | 1000               |

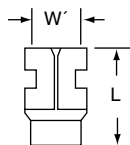

MU14-250DFHT/FLAG

Wire Range

16-14

Suggested Mate

MU14-250DMHT

### 3M™ High Temperature Male Disconnects\* — Butted Seam 900°F (482°C)

| Product Number <sup>†</sup> | UPC (054007-) | Wire Range (AWG) | Mates with Male Tab Width (W') x Thickness | L    | Barrel Length | Barrel I.D. | Terminals per: Carton | Case |
|-----------------------------|---------------|------------------|--|------|---------------|-------------|-----------------------|------|
| MU14-250DMHTX               | 49633         | 16-14            | 0.250 x 0.032                              | 0.73 | 0.25          | 0.090       | 100                   | 500  |
| MU14-250DMHTK               | 01765         | 16-14            | 0.250 x 0.032                              | 0.73 | 0.25          | 0.090       | —                     | 1000 |

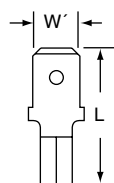

MU14-250DMHT

Wire Range

16-14

Suggested Mate

MU14-250DFHT

\*Steel with nickel plating

<sup>†</sup>Product number ending in X = box; product number ending with K = bulk.

# Closed End Connectors

## 3M™ Scotchlok Closed End Connector, Nylon Insulated, Copper Insert S-11-A and S-31-A

3M Scotchlok electrical crimp sleeve connectors make fast work of splicing 22 to 10 AWG copper conductors. Smooth flared entry makes wire insertion fast — simply twist conductors together and crimp. The S-11-A and S-31-A (copper) are insulated, closed-end crimp sleeve connectors. With a rugged, yet resilient nylon insulator, use these connectors in light fixtures, appliances and other electrical OEM applications.



### S-11-A Solid/Stranded AWG Wire Combinations: Copper Wire Only, "CU ONLY"

#### WIRE COMBINATIONS

|                          |
|--------------------------|
| 2 to 5 #22               |
| 1 to 4 #22 w/ 1 or 2 #20 |
| 1 to 3 #22 w/ 1 #18      |
| 1 #22 w/ 1 #16           |
| 2 or 3 #20               |

### S-31-A Solid/Stranded AWG Wire Combinations: Copper Wire Only, "CU ONLY"

#### WIRE COMBINATIONS

|                                |                                |
|--------------------------------|--------------------------------|
| 1 #22 w/ 1 #12 or #10          | 1 #20 w/ 1 #16 w/ 1 #12        |
| 1 #22 w/ 2 #14 or #16          | 1 #18 w/ 1 #14                 |
| 1 #22 w/ 1 #20 w/ 1 #12 or #14 | 1 #18 w/ 1 #12                 |
| 1 #22 w/ 1 #18 w/ 1 #12 or #14 | 1 #18 w/ 2 #16                 |
| 1 #22 w/ 1 #16 w/ 1 #12 or #14 | 1 #18 w/ 1 #16 w/ 1 #12 or #14 |
| 1 #22 w/ 1 #14 w/ 1 #12        | 1 #16 w/ 1 #12 or #14          |
| 1 or 2 #20 w/ 1 or 2 #14       | 3 #16                          |
| 1 or 2 #20 w/ 1 #12            | 1 #14 w/ 1 #12                 |
| 1 #20 w/ 1 #10                 | 2 #14                          |

## Specification Information for Nylon Insulated Closed End Connectors (Copper Insert)

| Product Number* | UPC (051138-) | Wire Range (AWG) | L    | Maximum Voltage Range | Temperature Rating |
|-----------------|---------------|------------------|------|-----------------------|--------------------|
| S-11-A          | 98051 boxed   | 22-16            | 0.83 | 600V                  | 221°F (105°C)      |
|                 | 98052 bulk    | 22-16            | 0.83 | 600V                  | 221°F (105°C)      |
| S-31-A          | 98043 boxed   | 18-10            | 1    | 600V                  | 221°F (105°C)      |
|                 | 98044 bulk    | 18-10            | 1    | 600V                  | 221°F (105°C)      |

## Ordering Information for Nylon Insulated Closed End Connectors (Copper Insert)

| Product Number | UPC (051138-) | Unit Pack | Case Qty |
|----------------|---------------|-----------|----------|
| S-11-A         | 98051 boxed   | 100/box   | 100      |
|                | 98052 bulk    | 1,000/bag | 10,000   |
| S-31-A         | 98043 boxed   | 50/box    | 500      |
|                | 98044 bulk    | 500/bag   | 5,000    |

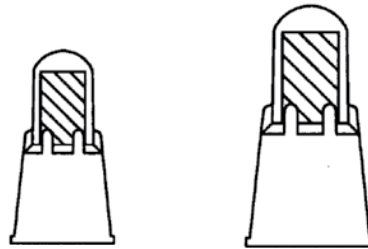

\*Product number ending in X = box; product number ending with K = bulk.

# Parallel Connectors

## 3M™ Parallel Connectors — Non-Insulated Seamless

| Product Number <sup>1</sup> | UPC (054007-) | Wire Range (AWG) | Copper Wire Combinations | L    | Thickness | Barrel I.D. In | Barrel I.D. CMA | Terminals per Case |
|-----------------------------|---------------|------------------|--------------------------|------|-----------|----------------|-----------------|--------------------|
| M14PCK                      | 01823         | 16-14            | See chart below          | 0.31 | 0.024     | 0.091          | 8281            | 1000               |
| M10PCK                      | 02083         | 12-10            | See chart below          | 0.34 | 0.024     | 0.152          | 23104           | 500                |

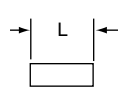

M14PC

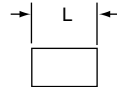

M10PC

Wire Range

16-14

12-10

## RECOMMENDED STRANDED WIRE COMBINATIONS

### MVU18PC

1 #22 to 1 #22, 20, 18, 16  
 1 #20 to 1 #20, 18, 16  
 1 #18 to 1 #18  
 Min. CMA: 1280, Max. CMA: 3600

### MVU10PC

1 #18 to 1 #18, 16, 14, 12, 10  
 1 #16 to 1 #16, 14, 12, 10  
 1 #14 to 1 #14, 12  
 Min. CMA: 3240, Max. CMA: 12860

### M14PC AND MVU14PC

1 #22 to 1 #22, 20, 18, 16, 14  
 1 #20 to 1 #20, 18, 16, 14  
 1 #18 to 1 #18, 16, 14  
 1 #16 to 1 #16  
 Min. CMA: 1280, Max. CMA: 5730

### M10PC

1 #18 to 1 #18, 16, 14, 12, 10  
 1 #16 to 1 #16, 14, 12, 10  
 1 #14 to 1 #14, 12, 10  
 1 #12 to 1 #12  
 Min. CMA: 3240, Max. CMA: 14490

Proper Wire Insertion Parallel Connectors

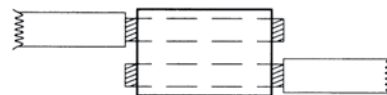

## 3M™ Parallel Connectors — Vinyl Insulated Butted Seam

| Product Number <sup>1</sup> | UPC (054007-) | Wire Range (AWG) | Copper Wire Combinations | L    | Thickness | Barrel Length | Barrel I.D. In | Barrel I.D. CMA | Maximum Insulation Diameter | Terminals per Carton | Case |
|-----------------------------|---------------|------------------|--------------------------|------|-----------|---------------|----------------|-----------------|-----------------------------|----------------------|------|
| MVU18PCK                    | 01318         | 22-18            | see chart above          | 0.67 | 0.030     | 0.31          | 0.070          | 4900            | 0.145                       | —                    | 1000 |
| MVU14PCX                    | 23144         | 16-14            | see chart above          | 0.67 | 0.030     | 0.31          | 0.090          | 8100            | 0.170                       | 100                  | 500  |
| MVU14PCK                    | 01824         | 16-14            | see chart above          | 0.67 | 0.030     | 0.31          | 0.090          | 8100            | 0.170                       | —                    | 1000 |
| MVU10PCK                    | 02084         | 12-10            | see chart above          | 0.87 | 0.040     | 0.31          | 0.135          | 18225           | 0.250                       | —                    | 500  |



MVU18PC



MVU14PC



MVU10PC

Wire Range

22-18

16-14

12-10

Wire Range

22-18

16-14

12-10

<sup>1</sup>Product number ending in X = box; product number ending with K = bulk.

# Pin Terminals

## 3M™ Pin Terminals — Non-Insulated

| Product Number <sup>1</sup> | UPC (051125-) | Wire Range (AWG) | Pin Diameter | L    | PL   | Terminals per: Carton | Case |
|-----------------------------|---------------|------------------|--------------|------|------|-----------------------|------|
| MU18-47PX                   | 57440         | 22-18            | 0.080        | 0.73 | 0.47 | 100                   | 500  |
| MU18-47PK                   | 57439         | 22-18            | 0.080        | 0.73 | 0.47 | —                     | 1000 |
| MU14-47PX                   | 57442         | 16-14            | 0.080        | 0.73 | 0.47 | 100                   | 500  |
| MU14-47PK                   | 57441         | 16-14            | 0.080        | 0.73 | 0.47 | —                     | 1000 |
| MU10-55PX                   | 49420*        | 12-10            | 0.110        | 0.81 | 0.55 | 50                    | 500  |
| MU10-55PK                   | 57443         | 12-10            | 0.110        | 0.81 | 0.55 | —                     | 500  |

\* UPC prefix 054007-

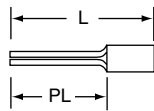

Wire Range  
MU18-47P  
22-18

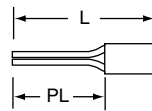

MU14-47P  
16-14

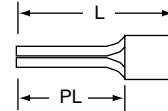

MU10-55P  
12-10

## 3M™ Pin Terminals — Vinyl Insulated Butted Seam

| Product Number <sup>1</sup> | UPC (051138-) | Wire Range (AWG) | Pin Diameter | L     | PL   | Maximum Insulation Diameter | Terminals per: Carton | Case |
|-----------------------------|---------------|------------------|--------------|-------|------|-----------------------------|-----------------------|------|
| MVU18-47PX                  | 98112         | 22-18            | 0.080        | 0.92  | 0.47 | 0.145                       | 100                   | 500  |
| MVU18-47PK                  | 98111         | 22-18            | 0.080        | 0.92  | 0.47 | 0.145                       | —                     | 1000 |
| MVU14-47PX                  | 98172         | 16-14            | 0.080        | 0.92  | 0.47 | 0.170                       | 100                   | 500  |
| MVU14-47PK                  | 98171         | 16-14            | 0.080        | 0.92  | 0.47 | 0.170                       | —                     | 1000 |
| MVU10-55PX                  | 98183         | 12-10            | 0.110        | 1.105 | 0.55 | 0.250                       | 50                    | 500  |
| MVU10-55PK                  | 98182         | 12-10            | 0.110        | 1.105 | 0.55 | 0.250                       | —                     | 500  |

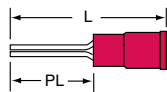

Wire Range  
MVU18-47P  
22-18

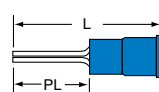

MVU14-47P  
16-14

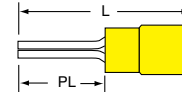

MVU10-55P  
12-10

## 3M™ Pin Terminals — Nylon Insulated with Insulation Grip

| Product Number <sup>1</sup> | UPC (051138-) | Wire Range (AWG) | Pin Diameter | L     | PL   | Maximum Insulation Diameter | Terminals per: Carton | Case |
|-----------------------------|---------------|------------------|--------------|-------|------|-----------------------------|-----------------------|------|
| MNG18-47PX                  | 98179         | 22-18            | 0.080        | 0.93  | 0.47 | 0.145                       | 100                   | 500  |
| MNG18-47PK                  | 98106         | 22-18            | 0.080        | 0.93  | 0.47 | 0.145                       | —                     | 1000 |
| MNG14-47PX                  | 98167         | 16-14            | 0.080        | 0.91  | 0.47 | 0.170                       | 100                   | 500  |
| MNG14-47PK                  | 98166         | 16-14            | 0.080        | 0.91  | 0.47 | 0.170                       | —                     | 1000 |
| MNG10-55PX                  | 98178         | 12-10            | 0.110        | 1.105 | 0.55 | 0.250                       | 50                    | 500  |
| MNG10-55PK                  | 98177         | 12-10            | 0.110        | 1.105 | 0.55 | 0.250                       | —                     | 500  |

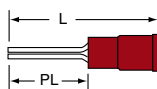

Wire Range  
MNG18-47P  
22-18

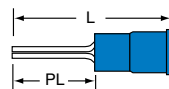

MNG14-47P  
16-14

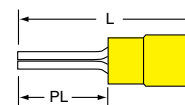

MNG10-55P  
12-10

<sup>1</sup>Product number ending in X = box; product number ending with K = bulk.



# 3M™ Highland™ Bagged Terminals

3M Highland terminals, disconnects, and connectors are for use in the assembly and maintenance of electrical systems. 3M Highland terminals offer effective and reliable performance in a variety of types of general applications.

Available in low quantity, reclosable bags 3M Highland terminals are the optimal choice for smaller jobs.



## 3M™ Highland™ Rings — Non-Insulated



| Product Number* | Wire Range | Stud or Tab Size | UPC (054007-) | Terminals/Bag | Bags/Case |
|-----------------|------------|------------------|---------------|---------------|-----------|
| R10-10L         | 12-10      | 10               | 70320         | 50            | 5         |
| R10-14L         | 12-10      | 1/4              | 70321         | 50            | 5         |
| R10-14Q         | 12-10      | 1/4              | 70475         | 25            | 10        |
| R14-4C          | 16-14      | 4                | 49896         | 100           | 5         |
| R14-6C          | 16-14      | 6                | 70235         | 100           | 5         |
| R14-6L          | 16-14      | 6                | 70322         | 50            | 10        |
| R14-8C          | 16-14      | 8                | 70236         | 100           | 5         |
| R14-8L          | 16-14      | 8                | 70323         | 50            | 10        |
| R14-10L         | 16-14      | 10               | 70324         | 50            | 10        |
| R18-4C          | 22-18      | 4                | 49902         | 100           | 5         |
| R18-6C          | 22-18      | 6                | 70238         | 100           | 5         |
| R18-6L          | 22-18      | 6                | 70325         | 50            | 10        |
| R18-8C          | 22-18      | 8                | 70239         | 100           | 5         |
| R18-8L          | 22-18      | 8                | 70326         | 50            | 10        |
| R18-10C         | 22-18      | 10               | 70240         | 100           | 5         |

\*Product Number ending in Q=25; L=50; C=100

## 3M™ Highland™ Rings — Vinyl Insulated



| Product Number <sup>1</sup> | Wire Range | Stud or Tab Size | UPC (054007-) | Terminals/Bag | Bags/Case |
|-----------------------------|------------|------------------|---------------|---------------|-----------|
| RV10-6L                     | 12-10      | 6                | 49893         | 50            | 5         |
| RV10-8L                     | 12-10      | 8                | 70328         | 50            | 5         |
| RV10-8Q                     | 12-10      | 8                | 70476         | 25            | 10        |
| RV10-10L                    | 12-10      | 10               | 70329         | 50            | 5         |
| RV10-10Q                    | 12-10      | 10               | 70477         | 25            | 10        |
| RV10-14L                    | 12-10      | 1/4              | 70330         | 50            | 5         |
| RV10-14Q                    | 12-10      | 1/4              | 70478         | 25            | 10        |
| RV10-38L                    | 12-10      | 3/8              | 70331         | 50            | 5         |
| RV10-38Q                    | 12-10      | 3/8              | 70479         | 25            | 10        |
| RV10-516Q                   | 12-10      | 5/16             | 49562         | 25            | 10        |
| RV14-6C                     | 16-14      | 6                | 70241         | 100           | 5         |
| RV14-6L                     | 16-14      | 6                | 70332         | 50            | 10        |
| RV14-8C                     | 16-14      | 8                | 70242         | 100           | 5         |
| RV14-8L                     | 16-14      | 8                | 70333         | 50            | 10        |
| RV14-10C                    | 16-14      | 10               | 70243         | 100           | 5         |
| RV14-10L                    | 16-14      | 10               | 70334         | 50            | 10        |
| RV14-14C                    | 16-14      | 1/4              | 70244         | 100           | 5         |
| RV14-14L                    | 16-14      | 1/4              | 70335         | 50            | 10        |
| RV14-516L                   | 16-14      | 5/16             | 49560         | 50            | 10        |
| RV18-6C                     | 22-18      | 6                | 70245         | 100           | 5         |
| RV18-6L                     | 22-18      | 6                | 70336         | 50            | 10        |
| RV18-8C                     | 22-18      | 8                | 70246         | 100           | 5         |
| RV18-8L                     | 22-18      | 8                | 70337         | 50            | 10        |
| RV18-10C                    | 22-18      | 10               | 70247         | 100           | 5         |
| RV18-10L                    | 22-18      | 10               | 70338         | 50            | 10        |

## 3M™ Highland Standard Forks — Non-Insulated



| Product Number <sup>1</sup> | Wire Range | Stud or Tab Size | UPC (054007-) | Terminals/Bag | Bags/Case |
|-----------------------------|------------|------------------|---------------|---------------|-----------|
| F14-6C                      | 16-14      | 6                | 70211         | 100           | 5         |
| F14-10C                     | 16-14      | 10               | 70213         | 100           | 5         |

<sup>1</sup>Product Number ending in Q=25; L=50; C=100



## 3M™ Highland™ Standard Forks — Vinyl Insulated



| Product Number* | Wire Range | Stud or Tab Size | UPC (054007-) | Terminals/Bag | Bags/Case |
|-----------------|------------|------------------|---------------|---------------|-----------|
| FV10-8L         | 12-10      | 8                | 70288         | 50            | 5         |
| FV10-8Q         | 12-10      | 8                | 70460         | 25            | 10        |
| FV10-10L        | 12-10      | 10               | 70289         | 50            | 5         |
| FV10-10Q        | 12-10      | 10               | 70461         | 25            | 10        |
| FV14-6L         | 16-14      | 6                | 70290         | 50            | 5         |
| FV14-8C         | 16-14      | 8                | 70225         | 100           | 10        |
| FV14-8L         | 16-14      | 8                | 70291         | 50            | 5         |
| FV14-10C        | 16-14      | 10               | 70226         | 100           | 10        |
| FV14-10L        | 16-14      | 10               | 70292         | 50            | 5         |

## 3M™ Highland Block Forks — Non-Insulated



| Product Number* | Wire Range | Stud or Tab Size | UPC (054007-) | Terminals/Bag | Bags/Case |
|-----------------|------------|------------------|---------------|---------------|-----------|
| BF10-8Q         | 12-10      | 8                | 70448         | 25            | 10        |
| BF10-10L        | 12-10      | 10               | 70250         | 50            | 5         |
| BF10-10Q        | 12-10      | 10               | 70449         | 25            | 10        |
| BF14-6L         | 16-14      | 6                | 70251         | 100           | 5         |
| BF14-8C         | 16-14      | 8                | 70198         | 100           | 50        |
| BF14-10C        | 16-14      | 10               | 70199         | 100           | 5         |
| BF18-6C         | 22-18      | 6                | 70200         | 100           | 5         |
| BF18-6L         | 22-18      | 6                | 70254         | 50            | 10        |
| BF18-8C         | 22-18      | 8                | 70201         | 100           | 5         |

\*Product Number ending in Q=25; L=50; C=100

## 3M™ Highland™ Block Forks — Vinyl Insulated



| Product Number <sup>1</sup> | Wire Range | Stud or Tab Size | UPC (054007-) | Terminals/Bag | Bags/Case |
|-----------------------------|------------|------------------|---------------|---------------|-----------|
| BFV10-6L                    | 12-10      | 6                | 49891         | 50            | 5         |
| BFV10-8L                    | 12-10      | 8                | 70256         | 50            | 5         |
| BFV10-8Q                    | 12-10      | 8                | 70450         | 25            | 10        |
| BFV10-10L                   | 12-10      | 10               | 70257         | 50            | 5         |
| BFV10-10Q                   | 12-10      | 10               | 70451         | 25            | 10        |
| BFV14-6C                    | 16-14      | 6                | 70202         | 100           | 5         |
| BFV14-6L                    | 16-14      | 6                | 70258         | 50            | 10        |
| BFV14-8C                    | 16-14      | 8                | 70203         | 100           | 5         |
| BFV14-8L                    | 16-14      | 8                | 70259         | 50            | 10        |
| BFV14-10C                   | 16-14      | 10               | 70204         | 100           | 5         |
| BFV14-10L                   | 16-14      | 10               | 70260         | 50            | 10        |
| BFV18-6C                    | 22-18      | 6                | 70205         | 100           | 5         |
| BFV18-6L                    | 22-18      | 6                | 70261         | 50            | 10        |
| BFV18-8C                    | 22-18      | 8                | 70206         | 100           | 5         |
| BFV18-8L                    | 22-18      | 8                | 70262         | 50            | 10        |
| BFV18-10C                   | 22-18      | 10               | 49899         | 100           | 5         |

## 3M™ Highland Locking Forks — Non-Insulated



| Product Number <sup>1</sup> | Wire Range | Stud or Tab Size | UPC (054007-) | Terminals/Bag | Bags/Case |
|-----------------------------|------------|------------------|---------------|---------------|-----------|
| LF10-8Q                     | 12-10      | 8                | 70463         | 25            | 10        |
| LF10-10Q                    | 12-10      | 10               | 70464         | 25            | 10        |
| LF10-14Q                    | 12-10      | 14               | 70465         | 25            | 10        |
| LF14-6L                     | 16-14      | 6                | 70293         | 50            | 10        |
| LF14-8L                     | 16-14      | 8                | 70294         | 50            | 10        |
| LF18-4L                     | 22-18      | 4                | 70296         | 50            | 10        |
| LF18-6L                     | 22-18      | 6                | 70297         | 50            | 10        |
| LF18-8L                     | 22-18      | 8                | 70298         | 50            | 10        |

## 3M™ Highland Locking Forks — Vinyl Insulated



| Product Number <sup>1</sup> | Wire Range | Stud or Tab Size | UPC (054007-) | Terminals/Bag | Bags/Case |
|-----------------------------|------------|------------------|---------------|---------------|-----------|
| LFV10-6Q                    | 12-10      | 6                | 70466         | 25            | 10        |
| LFV10-8Q                    | 12-10      | 8                | 70467         | 25            | 10        |
| LFV10-10Q                   | 12-10      | 10               | 70468         | 25            | 10        |
| LFV10-14Q                   | 12-10      | 14               | 70469         | 25            | 10        |
| LFV14-6L                    | 16-14      | 6                | 70299         | 50            | 10        |
| LFV14-8L                    | 16-14      | 8                | 70300         | 50            | 10        |
| LFV14-10L                   | 16-14      | 10               | 70301         | 50            | 10        |
| LFV18-6L                    | 22-18      | 6                | 70303         | 50            | 10        |
| LFV18-8L                    | 22-18      | 8                | 70304         | 50            | 10        |

<sup>1</sup>Product Number ending in Q=25; L=50; C=100



### 3M™ Highland™ Butt Splices



| Product Number* | Wire Range | Stud or Tab Size | UPC (054007-) | Terminals/Bag | Bags/Case |
|-----------------|------------|------------------|---------------|---------------|-----------|
| BS10L           | 12-10      | NA               | 70263         | 50            | 5         |
| BS10Q           | 12-10      | NA               | 70452         | 25            | 10        |
| BS14C           | 16-14      | NA               | 70207         | 100           | 5         |
| BS14L           | 16-14      | NA               | 70264         | 50            | 10        |
| BS18C           | 22-18      | NA               | 70208         | 100           | 5         |

### 3M™ Highland Butt Splices — Vinyl Insulated



| Product Number* | Wire Range | Stud or Tab Size | UPC (054007-) | Terminals/Bag | Bags/Case |
|-----------------|------------|------------------|---------------|---------------|-----------|
| BSV10L          | 12-10      | NA               | 70266         | 50            | 5         |
| BSV10Q          | 12-10      | NA               | 70453         | 25            | 10        |
| BSV14C          | 16-14      | NA               | 70209         | 100           | 5         |
| BSV14L          | 16-14      | NA               | 70267         | 50            | 10        |
| BSV18C          | 22-18      | NA               | 70210         | 100           | 5         |
| BSV18L          | 22-18      | NA               | 70268         | 50            | 10        |

### 3M™ Highland Female Disconnects — Non-Insulated



| Product Number* | Wire Range | Stud or Tab Size | UPC (054007-) | Terminals/Bag | Bags/Case |
|-----------------|------------|------------------|---------------|---------------|-----------|
| FD14-187C       | 16-14      | .187             | 49894         | 100           | 5         |
| FD14-187L       | 16-14      | .187             | 49895         | 50            | 10        |
| FD14-250C       | 16-14      | .250             | 70214         | 100           | 5         |
| FD14-250L       | 16-14      | .250             | 70275         | 50            | 10        |
| FD18-187C       | 22-18      | .187             | 49900         | 100           | 5         |
| FD18-187L       | 22-18      | .187             | 49901         | 50            | 10        |
| FD18-250L       | 22-18      | .250             | 70276         | 50            | 10        |

\*Product Number ending in Q=25; L=50; C=100

## 3M™ Highland™ Female Disconnects — Vinyl Insulated



| Product Number <sup>1</sup> | Wire Range | Stud or Tab Size | UPC (054007-) | Terminals/Bag | Bags/Case |
|-----------------------------|------------|------------------|---------------|---------------|-----------|
| FDV10-250L                  | 12-10      | .250             | 70282         | 50            | 5         |
| FDV10-250Q                  | 12-10      | .250             | 70458         | 25            | 10        |
| FDV14-187C                  | 16-14      | .187             | 70220         | 100           | 5         |
| FDV14-187L                  | 16-14      | .187             | 70283         | 50            | 10        |
| FDV14-250C                  | 16-14      | .250             | 70221         | 100           | 5         |
| FDV14-250L                  | 16-14      | .250             | 70284         | 50            | 10        |
| FDV18-187C                  | 22-18      | .187             | 70222         | 100           | 5         |
| FDV18-187L                  | 22-18      | .187             | 70285         | 50            | 10        |
| FDV18-250C                  | 22-18      | .250             | 70223         | 100           | 5         |
| FDV18-250L                  | 22-18      | .250             | 70286         | 50            | 10        |

## 3M™ Highland Female Disconnects — Nylon Fully Insulated



| Product Number <sup>1</sup> | Wire Range | Stud or Tab Size | UPC (054007-) | Terminals/Bag | Bags/Case |
|-----------------------------|------------|------------------|---------------|---------------|-----------|
| FDI10-250L                  | 12-10      | .250             | 70277         | 50            | 5         |
| FDI10-250Q                  | 12-10      | .250             | 70457         | 25            | 10        |
| FDI14-187L                  | 16-14      | .187             | 70278         | 50            | 10        |
| FDI14-250C                  | 16-14      | .250             | 70217         | 100           | 5         |
| FDI14-250L                  | 16-14      | .250             | 70279         | 50            | 10        |
| FDI18-187C                  | 22-18      | .187             | 70218         | 100           | 5         |
| FDI18-187L                  | 22-18      | .187             | 70280         | 50            | 10        |
| FDI18-250C                  | 22-18      | .250             | 70219         | 100           | 5         |
| FDI18-250L                  | 22-18      | .250             | 70281         | 50            | 10        |

## 3M™ Highland Male Tabs — Non-Insulated



| Product Number <sup>1</sup> | Wire Range | Stud or Tab Size | UPC (054007-) | Terminals/Bag | Bags/Case |
|-----------------------------|------------|------------------|---------------|---------------|-----------|
| MT10-250Q                   | 12-10      | .250             | 70470         | 25            | 10        |
| MT14-250L                   | 16-14      | .250             | 70306         | 50            | 10        |
| MT18-187L                   | 22-18      | .187             | 70307         | 50            | 10        |
| MT18-250L                   | 22-18      | .250             | 70308         | 50            | 10        |

<sup>1</sup>Product Number ending in Q=25; L=50; C=100



### 3M™ Highland™ Male Tabs — Nylon Fully Insulated



| Product Number* | Wire Range | Stud or Tab Size | UPC (054007-) | Terminals/Bag | Bags/Case |
|-----------------|------------|------------------|---------------|---------------|-----------|
| MTI10-250L      | 12-10      | .250             | 70309         | 50            | 5         |
| MTI10-250Q      | 12-10      | .250             | 70471         | 25            | 10        |
| MTI14-187C      | 16-14      | .187             | 70227         | 100           | 5         |
| MTI14-187L      | 16-14      | .187             | 70310         | 50            | 10        |
| MTI14-250C      | 16-14      | .250             | 70228         | 100           | 5         |
| MTI14-250L      | 16-14      | .250             | 70311         | 50            | 10        |
| MTI18-187C      | 22-18      | .187             | 70229         | 100           | 5         |
| MTI18-187L      | 22-18      | .187             | 70312         | 50            | 10        |
| MTI18-250L      | 22-18      | .250             | 70313         | 50            | 10        |

### 3M™ Highland Male Tabs — Vinyl Insulated



| Product Number* | Wire Range | Stud or Tab Size | UPC (054007-) | Terminals/Bag | Bags/Case |
|-----------------|------------|------------------|---------------|---------------|-----------|
| MTV10-250L      | 12-10      | .250             | 70314         | 50            | 5         |
| MTV10-250Q      | 12-10      | .250             | 70472         | 25            | 10        |
| MTV14-187C      | 16-14      | .187             | 70231         | 100           | 5         |
| MTV14-250C      | 16-14      | .250             | 70232         | 100           | 5         |
| MTV14-250L      | 16-14      | .250             | 70316         | 50            | 10        |
| MTV18-187C      | 22-18      | .187             | 70233         | 100           | 5         |
| MTV18-187L      | 22-18      | .187             | 70317         | 50            | 10        |
| MTV18-250L      | 22-18      | .250             | 70318         | 50            | 10        |

### 3M™ Highland Snap Plugs — Vinyl Insulated



| Product Number* | Wire Range | Stud or Tab Size | UPC (054007-) | Terminals/Bag | Bags/Case |
|-----------------|------------|------------------|---------------|---------------|-----------|
| SPV14-156L      | 16-14      | .156             | 70342         | 50            | 10        |
| SPV18-156L      | 22-18      | .156             | 70343         | 50            | 10        |

### 3M™ Highland Snap Receptacles — Nylon Fully Insulated



| Product Number* | Wire Range | Stud or Tab Size | UPC (054007-) | Terminals/Bag | Bags/Case |
|-----------------|------------|------------------|---------------|---------------|-----------|
| SRI14-156L      | 16-14      | .156             | 70340         | 50            | 10        |

\*Product Number ending in Q=25; L=50; C=100

# Kits

## 3M™ Scotchlok™ Terminal Kit STK-1 (Filled)

The Scotchlok Terminal Kit is filled with 3M's most frequently purchased low voltage termination products, including 14 of our most popular terminals.



The STK-1 is constructed of durable metal with individual product compartments. While the compartments keep you organized, the rugged metal frame protects the contents even in the harshest environment. Overall box size is 13-3/4" L x 10" W x 2-1/2" H

| Product                      | UPC<br>051138- | Color | Boxes/<br>Bag | Boxes/<br>Case |
|------------------------------|----------------|-------|---------------|----------------|
| Scotchlok Terminal Box STK-1 | 25348          | Red   | N/A           | 1              |

## Contents of STK-1

| Product                                   | Quantity |
|---|----------|
| Scotchlok Crimping Tool TH-440            | 1        |
| 3M™ ScotchCode™ Tape Dispenser STD-0-9    | 1        |
| 3M Cable Ties 06225                       | 100      |
| 3M Cable Ties 06226                       | 100      |
| 3M Highland™ Ring Tongue Terminal RV18-6  | 50       |
| 3M Highland Ring Tongue Terminal RV18-8   | 50       |
| 3M Highland Ring Tongue Terminal RV14-6   | 50       |
| 3M Highland Ring Tongue Terminal RV14-8   | 50       |
| 3M Highland Ring Tongue Terminal RV14-10  | 50       |
| 3M Highland Ring Tongue Terminal RV10-10  | 25       |
| 3M Highland Block Fork Terminals BFV14-8  | 50       |
| 3M Highland Block Fork Terminals BFV14-10 | 50       |
| 3M Highland Block Fork Terminals BFV18-8  | 50       |
| 3M Highland Block Fork Terminals BFV18-6  | 50       |
| 3M Highland Butt Connectors BSV18         | 50       |
| 3M Highland Butt Connectors BSV14         | 50       |
| 3M Highland Butt Connectors BSV10         | 25       |
| 3M Highland Female Disconnects FDV14-250  | 50       |

## 3M™ Scotchlok™ Steel Terminal Box (Empty)

This metal case with plastic insert tray is divided into 14 terminal compartments, one tool compartment and two miscellaneous compartments. Order contents separately. Overall box size is 13-3/4" L x 10" W x 2-1/2" H



| Product                      | UPC<br>(054007-) | Color | Boxes/<br>Bag | Boxes/<br>Case |
|------------------------------|------------------|-------|---------------|----------------|
| Scotchlok Steel Terminal Box | 11900            | Red   | 1             | 6              |
| Note: Box only               |                  |       |               |                |

## 3M™ Scotchlok™ Plastic Terminal Box (Empty)

This is a plastic organizing box for terminals. It is divided into 13 compartments, including one size to hold a crimping tool. Order contents separately. Overall box size is 11" L x 7" W x 1-3/4" H.



| Product                        | UPC<br>(054007-) | Color | Boxes/<br>Bag | Boxes/<br>Case |
|--------------------------------|------------------|-------|---------------|----------------|
| Scotchlok Plastic Terminal Box | 02351            | Clear | 1             | 24             |
| Note: Box only                 |                  |       |               |                |



# Tools

## 3M™ Scissors, Style TH-440

A compact, high-quality tool designed to perform the six most common electrical wiring functions.

- Made of 1.125" (28,57 mm) heat-treated carbon steel
- Handles a variety of terminal and connector styles, insulated and non-insulated
- Range of 22–10 AWG
- 3M Terminals and Connectors are UL Listed and CSA Certified when used with the TH-440

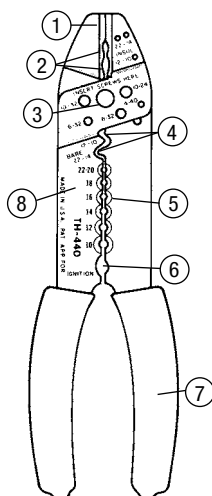

### Features:

1. Anvil-type wire cutter for clean cuts.
2. Crimp dies for 22–10 AWG insulated terminals, connectors and closed-end connectors.
3. Cut-off dies for mild steel and non-ferrous screws.
4. Crimp dies for 22–10 AWG non-insulated terminals and connectors.
5. Wire stripping stations for circumferential cut-less effort.
6. Crimp die for 7 and 8 mm ignition parts.
7. Cushioned, vinyl grips, red.

For specific tooling applications, refer to the smallest units container or the Tool Selection Guides in the Appendix.

| Product Number (add package code when ordering) | UPC (054007-) | Color | Boxes/ Bag | Boxes/ Case |
|---|---------------|-------|------------|-------------|
| TH-440  | 60825         | 22-10 | 1          | 10          |

## 3M™ Scissors, Style TH-450

The most versatile heavy-duty tool we've ever offered.

- Made of 1.40" (35,5 mm) high-strength, heat-treated carbon steel
- Tool is lightweight without sacrificing strength
- Handles a variety of terminal and conductor styles, including flags, closed-end connectors, crimp sleeves and standard parts, insulated and non-insulated
- Range of 26–6 AWG
- 3M Terminals and Connectors are UL Listed and CSA Certified when crimped with the TH-450

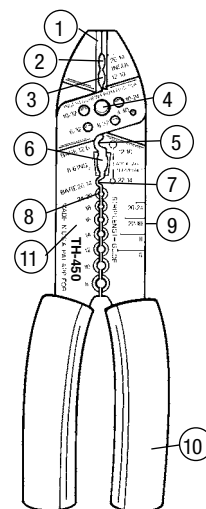

### Features:

1. Anvil-type wire cutter.
- 2–3. Crimp dies for 26–10 AWG insulated terminals and closed-end connectors.
4. Cut-off dies for mild steel and non-ferrous screws.
5. Crimp dies for 12–6 AWG non-insulated terminals, connectors, flags, disconnects, crimp sleeves and high-temperature terminals.
6. Crimp dies for 6–8 AWG insulated terminals and butt connectors.
7. Crimp die for 26–14 AWG non-insulated terminals, connectors, flags, disconnects and crimp sleeves.
8. Wire-stripping stations for circumferential cut-less effort.
9. Strip length guide.
10. Textured, cushioned grips, red.

For specific tooling applications, refer to the smallest unit container or the Tool Selection Guides in the Appendix.

| Product Number (add package code when ordering) | UPC (054007-) | Color | Boxes/ Bag | Boxes/ Case |
|---|---------------|-------|------------|-------------|
| TH-450  | 13760         | 26-6  | 1          | 10          |

\*Product number ending in X = box; product number ending with K = bulk.

## 3M™ Ratchet TR-482

### Tool Capability:

Crimps barrel and insulation grip simultaneously on No. 22–10 AWG (0,35–6,0 mm<sup>2</sup>) insulated terminals and connectors. Will crimp nylon or vinyl insulated, butted or brazed seam terminals and connectors.

### Crimping Dies:

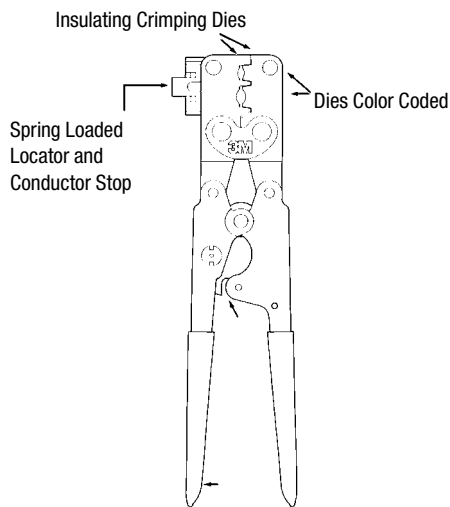

No. 22–14 AWG (0,35–2,5 mm<sup>2</sup>) red and blue color coded

No. 12–10 AWG (4,0–6,0 mm<sup>2</sup>) yellow color coded

### Field Re-calibration:

Calibration of ratchet can be accomplished in the field. See calibration and maintenance instructions packaged with the tool.

### Terminal Locator:

Spring loaded locator orients, positions and holds terminals and connectors.

### Conductor Stop:

Provides proper insertion of conductor in the terminal barrel.

### Positive Closure:

Ratchet requires full closure of handles to ensure proper crimp.

### Materials and Finish:

Hardened steel jaws and handles with corrosion resistant finish.

### Weight:

1.1 lbs.

### Grip:

Plastic, red color

### Specifications:

Insulated terminals from 22–10 AWG should be crimped with a positive action ratchet tool and be UL Listed with that tool. The dies are of a smooth, contour shape and crimp the conductor barrel and insulation grip simultaneously. The tool has a locator that will orient the terminal, position the terminal for crimping, hold the terminals in place, and act as a wire stop. The tool is compound lever type with a ratchet mechanism to ensure positive closure for full crimping cycle. The tool is capable of field adjustment to proper calibration with common tools and materials specified in the maintenance and calibration section of the instruction booklet provided with the tool. The manufacturer provides a guide for maintenance procedure and instructions to field inspect for specified die gaps. Jaws should be hardened steel and coated with a corrosion resistant finish. Tool should be a Scotchlok™ TR-482.

3M™ Terminals and Connectors are UL Listed and CSA Certified with the TR-482. For specific tooling information, see Tool Selection Guide in the Appendix

| Product | UPC<br>(054007-) | Wire Range | Tools/<br>Carton | Tools/<br>Case |
|---------|------------------|------------|------------------|----------------|
| TR-482  | 11902            | 22-10      | 1                | 10             |

## 3M™ Ratchet TR-490

### Tool Capability:

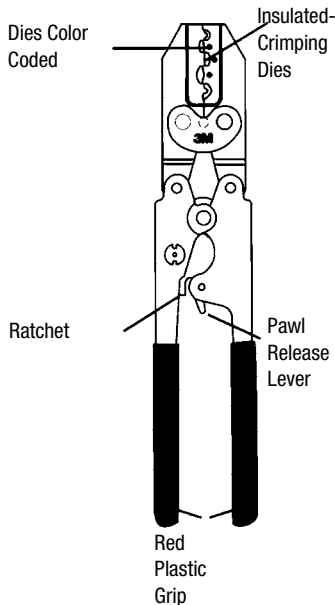

### Tool Capability:

Crimps barrel and insulation grip independently on No. 22–10 AWG (0,35–6,0 mm<sup>2</sup>) insulated and non-insulated terminals and connectors—nylon or vinyl insulated, butted or brazed seam.

### Crimping Dies:

Insulated No. 22–18 AWG (0,35–0,97 mm<sup>2</sup>) red color coded

Insulated No. 16–14 AWG (1,3–25 mm<sup>2</sup>) blue color coded

Insulated No. 12–10 AWG (4,0–6,0 mm<sup>2</sup>) yellow color coded

Non-Insulated No. 22–14 AWG (0,35–2,5 mm<sup>2</sup>)

Non-Insulated No. 12–10 (4,0–6,0 mm<sup>2</sup>)

### Field Re-calibration:

Calibration adjustment of ratchet can be accomplished in the field. See calibration and maintenance instructions packaged with the tool.

### Positive Closure:

Ratchet requires full closure of handles to ensure proper crimp. Ratchet release lever allows removal of misplaced terminals.

### Materials and Finish:

Hardened steel jaws and handles with corrosion resistant finish.

### Weight:

0.8 lbs.

### Grip:

Plastic, red color



























### Specifications:

Non-insulated and insulated terminals and connectors from 22–10 AWG should be crimped with a positive action (ratchet) tool and be UL Listed with that tool. Non-insulated die is of an indent shape and insulated die is a flat, smooth shape capable of crimping pre-insulated vinyl and nylon terminals and connectors. Dies are marked with the appropriate wire range and insulated dies are color coded: red for 22–18 AWG, blue for 16–14 AWG, and yellow for 12–10 AWG. The tool is compound lever type with a ratchet mechanism to ensure positive closure for full crimping cycle. Tool is capable of field adjustment to proper calibration with common tools and materials specified in the maintenance and calibration section of the instruction booklet provided with the tool. The manufacturer provides a guide for maintenance procedure and instructions to field inspect for specified die gaps. Jaws should be hardened steel and coated with a corrosion resistant finish. Tool should be a 3M Scotchlok TR-490.

3M™ Terminals and Connectors are UL Listed and CSA Certified with the TR-490. For specific tooling information, see Tool Selection Guide in the the Appendix

| Product | UPC (054007-) | Wire Range | Tools/ Carton | Tools/ Case |
|---------|---------------|------------|---------------|-------------|
| TR-490  | 70481         | 22-10      | 1             | 10          |

# 3M™ Terminal Stud Size Chart

|      | Stud Size   |                     |      |   | 3M Terminal Hole Diameter |                  |
|------|---|---------------------|------|---|---------------------------|------------------|
|      | US/Inches   | Diameter            |      | OUS/Metric  |                           |                  |
| #2   |    | 0.086" (2,144 mm)   | M2   |    | 2,0 mm (0.080")           | 0.095" (2,4 mm)  |
| #4   |    | 0.112" (2,844 mm)   | M2,5 |    | 2,5 mm (0.100")           | 0.120" (3,0 mm)  |
| #5   |    | 0.125" (3,175 mm)   | M3   |    | 3,0 mm (0.120")           | 0.148" (3,8 mm)  |
| #6   |    | 0.138" (3,505 mm)   | M3,5 |    | 3,5 mm (0.140")           | 0.148" (3,8 mm)  |
| #8   |    | 0.164" (4,166 mm)   | M4   |    | 4,0 mm (0.176")           | 0.174" (4,4 mm)  |
| #10  |    | 0.190" (4,826 mm)   | M5   |    | 5,0 mm (0.20")            | 0.200" (5,1 mm)  |
| 1/4  |    | 0.250" (6,350 mm)   | M6   |    | 6,0 mm (0.24")            | 0.265" (6,7 mm)  |
| 5/16 |    | 0.3125" (7,938 mm)  | M8   |    | 8,0 mm (0.32")            | 0.328" (8,3 mm)  |
| 3/8  |    | 0.375" (9,525 mm)   | M10  |    | 10,0 mm (0.40")           | 0.397" (10,1 mm) |
| 7/16 |    | 0.4375" (11,113 mm) | M10  |    | 10,0 mm (0.48")           | 0.450" (11,4 mm) |
| 1/2  |  | 0.500" (12,700 mm)  | M12  |  | 12,0 mm (0.48")           | 0.515" (13,1 mm) |
| 5/8  |  | 0.625" (15,875 mm)  | M16  |  | 16,0 mm (0.64")           | 0.656" (16,7 mm) |
| 3/4  |  | 0.750" (19,050 mm)  | M18  |  | 18,0 mm (0.72")           | 0.781" (19,8 mm) |

Ref: ISO 263-1973 for inch stud sizes and ISO 262-1973 for metric stud sizes

## American Wire Gauge

| Size | Inches | Millimeters | Size | Inches | Millimeters | Size | Inches | Millimeters |
|------|--------|-------------|------|--------|-------------|------|--------|-------------|
| 4/0  | 0.4600 | 11,684      | 4    | 0.2043 | 5,189       | 16   | 0.0508 | 1,290       |
| 3/0  | 0.4096 | 10,040      | 6    | 0.1620 | 4,115       | 18   | 0.0403 | 1,024       |
| 2/0  | 0.3648 | 9,266       | 8    | 0.1285 | 3,264       | 20   | 0.0320 | 0,813       |
| 1/0  | 0.3249 | 8,253       | 10   | 0.1019 | 2,588       | 22   | 0.0253 | 0,643       |
| 1    | 0.2893 | 7,347       | 12   | 0.0808 | 2,052       | 24   | 0.0201 | 0,511       |
| 2    | 0.2576 | 6,543       | 14   | 0.0641 | 1,628       | 26   | 0.0159 | 0,404       |

## Данный компонент на территории Российской Федерации

### Вы можете приобрести в компании MosChip.

Для оперативного оформления запроса Вам необходимо перейти по данной ссылке:

<http://moschip.ru/get-element>

Вы можете разместить у нас заказ для любого Вашего проекта, будь то серийное производство или разработка единичного прибора.

В нашем ассортименте представлены ведущие мировые производители активных и пассивных электронных компонентов.

Нашей специализацией является поставка электронной компонентной базы двойного назначения, продукции таких производителей как XILINX, Intel (ex.ALTERA), Vicor, Microchip, Texas Instruments, Analog Devices, Mini-Circuits, Amphenol, Glenair.

Сотрудничество с глобальными дистрибьюторами электронных компонентов, предоставляет возможность заказывать и получать с международных складов практически любой перечень компонентов в оптимальные для Вас сроки.

На всех этапах разработки и производства наши партнеры могут получить квалифицированную поддержку опытных инженеров.

Система менеджмента качества компании отвечает требованиям в соответствии с ГОСТ Р ИСО 9001, ГОСТ РВ 0015-002 и ЭС РД 009

### Офис по работе с юридическими лицами:

105318, г.Москва, ул.Щербаковская д.3, офис 1107, 1118, ДЦ «Щербаковский»

Телефон: +7 495 668-12-70 (многоканальный)

Факс: +7 495 668-12-70 (доб.304)

E-mail: [info@moschip.ru](mailto:info@moschip.ru)

Skype отдела продаж:

moschip.ru

moschip.ru\_4

moschip.ru\_6

moschip.ru\_9