

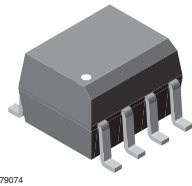

Optocoupler, Phototransistor Output, with Base Connection in SOIC-8 Package

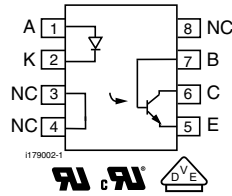

1179074



FEATURES

- High BV<sub>CEO</sub>, 70 V
• Isolation test voltage, 4000 V<sub>RMS</sub>
• Material categorization: For definitions of compliance please see www.vishay.com/doc?99912



RoHS COMPLIANT

DESCRIPTION

The VO205AT, VO206AT, VO207AT, VO208AT are optically coupled pairs with a gallium arsenide infrared LED and a silicon NPN phototransistor. Signal information, including a DC level, can be transmitted by the device while maintaining a high degree of electrical isolation between input and output. This family comes in a standard SOIC-8A small outline package for surface mounting which makes them ideally suited for high density application with limited space.

AGENCY APPROVALS

- UL1577, file no. E52744 system code Y
• cUL - file no. E52744, equivalent to CSA bulletin 5A
• DIN EN 60747-5-5 (VDE 0884-5) approved, contact customer service if this option is required

ORDERING INFORMATION

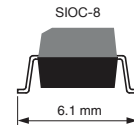
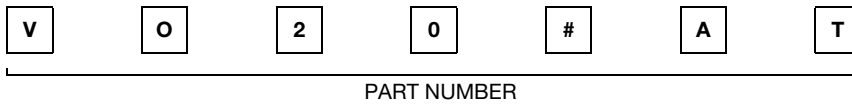

Table with columns: AGENCY CERTIFIED/PACKAGE, CTR (%), and sub-columns for UL, cUL, SOIC-8, VO205AT, VO206AT, VO207AT, VO208AT.

ABSOLUTE MAXIMUM RATINGS (T<sub>amb</sub> = 25 °C, unless otherwise specified)

Table with columns: PARAMETER, TEST CONDITION, SYMBOL, VALUE, UNIT. Rows include INPUT, OUTPUT, and COUPLER sections.

Note

- Stresses in excess of the absolute maximum ratings can cause permanent damage to the device. Functional operation of the device is not implied at these or any other conditions in excess of those given in the operational sections of this document. Exposure to absolute maximum ratings for extended periods of the time can adversely affect reliability.

**ELECTRICAL CHARACTERISTICS** ( $T_{amb} = 25\text{ }^{\circ}\text{C}$ , unless otherwise specified)

| PARAMETER                             | TEST CONDITION                          | PART | SYMBOL      | MIN. | TYP. | MAX. | UNIT          |
|---------------------------------------|---|------|-------------|------|------|------|---------------|
| <b>INPUT</b>                          |   |      |             |      |      |      |               |
| Forward voltage                       | $I_F = 10\text{ mA}$                    |      | $V_F$       |      | 1.3  | 1.5  | V             |
| Reverse current                       | $V_R = 6\text{ V}$                      |      | $I_R$       |      | 0.1  | 100  | $\mu\text{A}$ |
| Capacitance                           | $V_R = 0\text{ V}$                      |      | $C_O$       |      | 13   |      | pF            |
| <b>OUTPUT</b>                         |   |      |             |      |      |      |               |
| Collector emitter breakdown voltage   | $I_C = 100\text{ }\mu\text{A}$          |      | $BV_{CEO}$  | 70   |      |      | V             |
| Emitter collector breakdown voltage   | $I_E = 10\text{ }\mu\text{A}$           |      | $BV_{ECO}$  | 7    | 10   |      | V             |
| Collector base breakdown voltage      | $I_C = 100\text{ }\mu\text{A}$          |      | $BV_{CBO}$  | 100  |      |      | V             |
| Collector base current                |   |      | $I_{CBO}$   |      |      | 1    | nA            |
| Emitter base current                  |   |      | $I_{EBO}$   |      |      | 1    | nA            |
| Collector emitter leakage current     | $V_{CE} = 10\text{ V}$                  |      | $I_{CEO}$   |      | 5    | 50   | nA            |
| Saturation voltage, collector emitter | $I_C = 2\text{ mA}, I_F = 10\text{ mA}$ |      | $V_{CEsat}$ |      |      | 0.4  | V             |
| <b>COUPLER</b>                        |   |      |             |      |      |      |               |
| Capacitance, input to output          |   |      | $C_{IO}$    |      | 0.5  |      | pF            |

**Note**

- Minimum and maximum values were tested requirements. Typical values are characteristics of the device and are the result of engineering evaluations. Typical values are for information only and are not part of the testing requirements.

**CURRENT TRANSFER RATIO**

| PARAMETER | TEST CONDITION                            | PART    | SYMBOL | MIN. | TYP. | MAX. | UNIT |
|-----------|---|---------|--------|------|------|------|------|
| $I_C/I_F$ | $I_F = 10\text{ mA}, V_{CE} = 5\text{ V}$ | VO205AT | CTR    | 40   |      | 80   | %    |
|           |   | VO206AT | CTR    | 63   |      | 125  | %    |
|           |   | VO207AT | CTR    | 100  |      | 200  | %    |
|           |   | VO208AT | CTR    | 160  |      | 320  | %    |

**SWITCHING CHARACTERISTICS**

| PARAMETER     | TEST CONDITION   | PART | SYMBOL    | MIN. | TYP. | MAX. | UNIT          |
|---------------|--|------|-----------|------|------|------|---------------|
| Turn-on time  | $I_C = 2\text{ mA}, R_L = 100\text{ }\Omega, V_{CC} = 10\text{ V}$ |      | $t_{on}$  |      | 3    |      | $\mu\text{s}$ |
| Turn-off time | $I_C = 2\text{ mA}, R_L = 100\text{ }\Omega, V_{CC} = 10\text{ V}$ |      | $t_{off}$ |      | 3    |      | $\mu\text{s}$ |
| Rise time     | $I_C = 2\text{ mA}, R_L = 100\text{ }\Omega, V_{CC} = 10\text{ V}$ |      | $t_r$     |      | 3    |      | $\mu\text{s}$ |
| Fall time     | $I_C = 2\text{ mA}, R_L = 100\text{ }\Omega, V_{CC} = 10\text{ V}$ |      | $t_f$     |      | 2    |      | $\mu\text{s}$ |

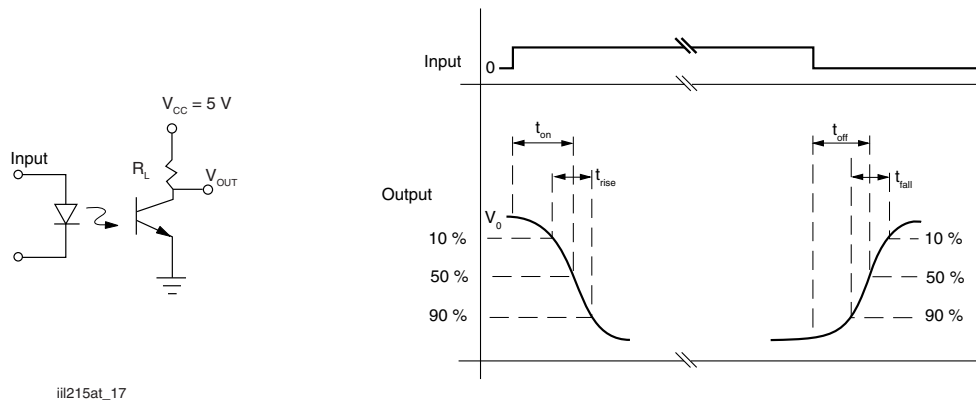

Fig. 1 Switching Test Circuit

**COMMON MODE TRANSIENT IMMUNITY**

| PARAMETER                                    | TEST CONDITION   | SYMBOL     | MIN. | TYP. | MAX. | UNIT                   |
|--|--|------------|------|------|------|------------------------|
| Common mode transient immunity at logic high | $V_{CM} = 1000 \text{ V}_{P-P}$ , $R_L = 1 \text{ k}\Omega$ ,<br>$I_F = 0 \text{ mA}$  | $ C_{MH} $ |      | 5000 |      | $\text{V}/\mu\text{s}$ |
| Common mode transient immunity at logic low  | $V_{CM} = 1000 \text{ V}_{P-P}$ , $R_L = 1 \text{ k}\Omega$ ,<br>$I_F = 10 \text{ mA}$ | $ C_{ML} $ |      | 5000 |      | $\text{V}/\mu\text{s}$ |

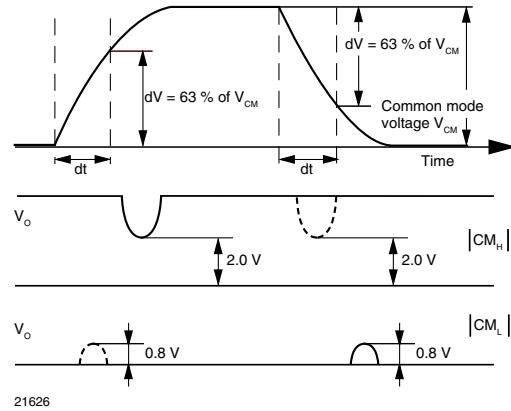
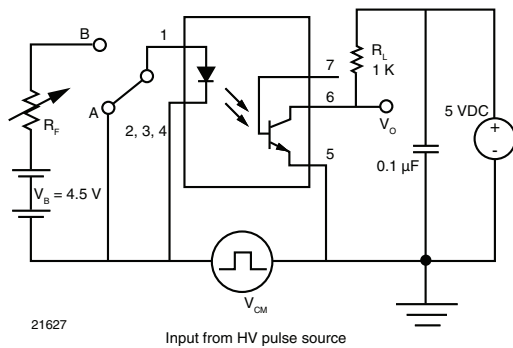

Fig. 1 - Test Circuit for Common Mode Transient Immunity

**SAFETY AND INSULATION RATINGS**

| PARAMETER  | TEST CONDITION | SYMBOL     | MIN. | TYP.      | MAX. | UNIT               |
|--|----------------|------------|------|-----------|------|--------------------|
| Climatic classification (according to IEC 68 part 1) |                |            |      | 40/100/21 |      |                    |
| Polution degree                                      |                |            |      | 2         |      |                    |
| Comparative tracking index                           |                | CTI        | 175  |           | 399  |                    |
| Isolation test voltage                               | 1 s            | $V_{ISO}$  | 4000 |           |      | $V_{RMS}$          |
| Peak transient overvoltage                           |                | $V_{IOTM}$ | 6000 |           |      | V                  |
| Peak insulation voltage                              |                | $V_{IORM}$ | 560  |           |      | V                  |
| Resistance (input to output)                         |                | $R_{IO}$   |      | 100       |      | $G\Omega$          |
| Safety rating - power output                         |                | $P_{SO}$   |      |           | 350  | mW                 |
| Safety rating - input current                        |                | $I_{SI}$   |      |           | 150  | mA                 |
| Safety rating - temperature                          |                | $T_{SI}$   |      |           | 165  | $^{\circ}\text{C}$ |
| External creepage distance                           |                |            | 4    |           |      | mm                 |
| External clearance distance                          |                |            | 4    |           |      | mm                 |
| Internal creepage distance                           |                |            | 3.3  |           |      | mm                 |
| Insulation thickness                                 |                |            | 0.2  |           |      | mm                 |

**Note**

- As per IEC 60747-5-2, §7.4.3.8.1, this optocoupler is suitable for "safe electrical insulation" only within the safety ratings. Compliance with the safety ratings shall be ensured by means of protective circuits.



TYPICAL CHARACTERISTICS (T<sub>amb</sub> = 25 °C, unless otherwise specified)

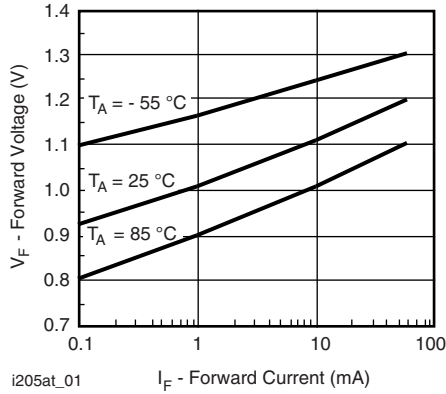

Fig. 2 - Forward Voltage vs. Forward Current

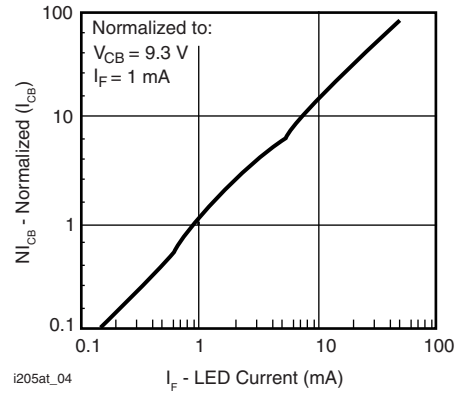

Fig. 5 - Normalized Collector-Base Photocurrent vs. LED Current

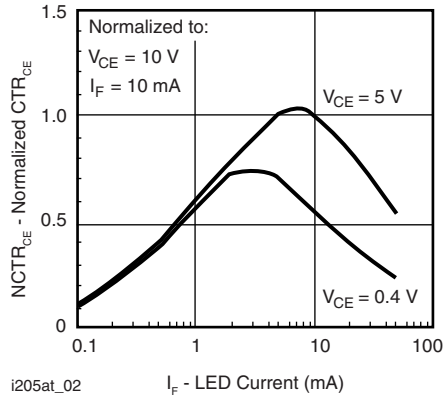

Fig. 3 - Normalized Non-Saturated and Saturated CTR<sub>CE</sub> vs. LED Current

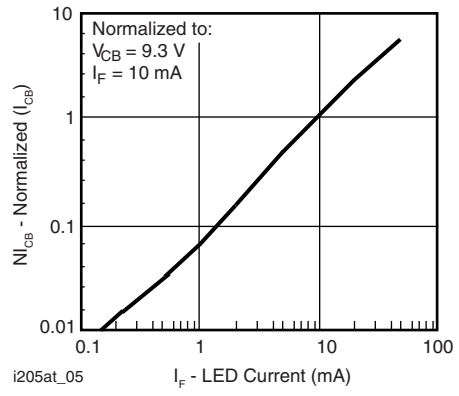

Fig. 6 - Normalized Collector-Base Photocurrent vs. LED Current

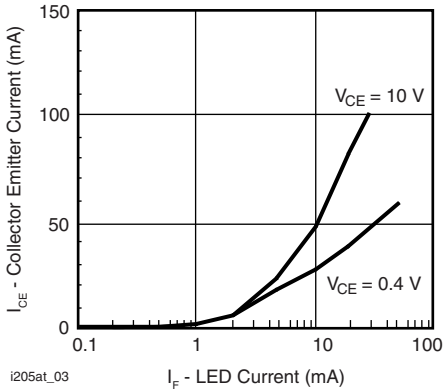

Fig. 4 - Collector Emitter Current vs. LED Current

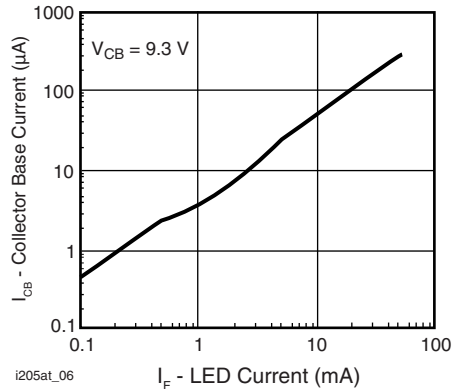
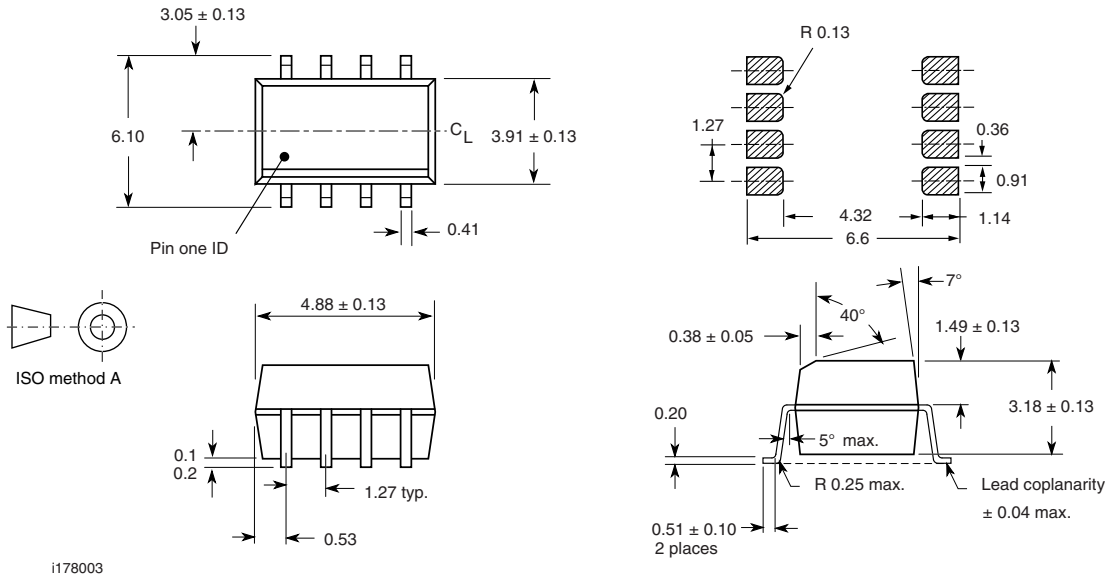
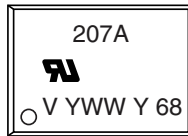

Fig. 7 - Collector Base Photocurrent vs. LED Current

## PACKAGE DIMENSIONS in millimeters



## PACKAGE MARKING (example of VO207AT)



## TAPE AND REEL PACKAGING

Dimensions in millimeters

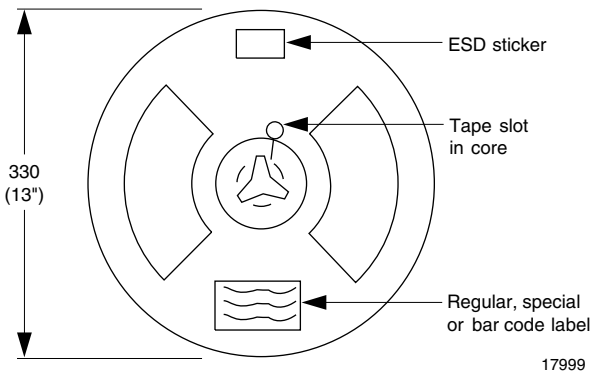

Fig. 8 - Tape and Reel Shipping Medium (EIA-481, revision A, and IEC 60286), 2000 units per reel

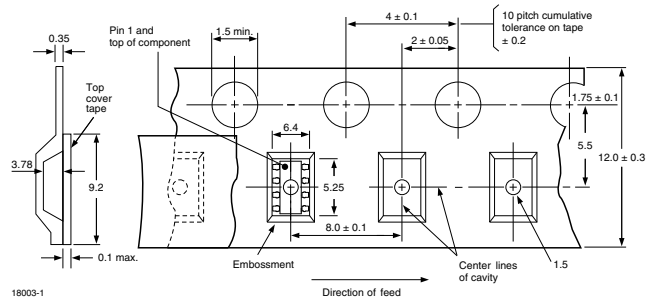

Fig. 9 - Tape Dimensions, 2000 Parts per Reel



## Disclaimer

ALL PRODUCT, PRODUCT SPECIFICATIONS AND DATA ARE SUBJECT TO CHANGE WITHOUT NOTICE TO IMPROVE RELIABILITY, FUNCTION OR DESIGN OR OTHERWISE.

Vishay Intertechnology, Inc., its affiliates, agents, and employees, and all persons acting on its or their behalf (collectively, "Vishay"), disclaim any and all liability for any errors, inaccuracies or incompleteness contained in any datasheet or in any other disclosure relating to any product.

Vishay makes no warranty, representation or guarantee regarding the suitability of the products for any particular purpose or the continuing production of any product. To the maximum extent permitted by applicable law, Vishay disclaims (i) any and all liability arising out of the application or use of any product, (ii) any and all liability, including without limitation special, consequential or incidental damages, and (iii) any and all implied warranties, including warranties of fitness for particular purpose, non-infringement and merchantability.

Statements regarding the suitability of products for certain types of applications are based on Vishay's knowledge of typical requirements that are often placed on Vishay products in generic applications. Such statements are not binding statements about the suitability of products for a particular application. It is the customer's responsibility to validate that a particular product with the properties described in the product specification is suitable for use in a particular application. Parameters provided in datasheets and/or specifications may vary in different applications and performance may vary over time. All operating parameters, including typical parameters, must be validated for each customer application by the customer's technical experts. Product specifications do not expand or otherwise modify Vishay's terms and conditions of purchase, including but not limited to the warranty expressed therein.

Except as expressly indicated in writing, Vishay products are not designed for use in medical, life-saving, or life-sustaining applications or for any other application in which the failure of the Vishay product could result in personal injury or death. Customers using or selling Vishay products not expressly indicated for use in such applications do so at their own risk. Please contact authorized Vishay personnel to obtain written terms and conditions regarding products designed for such applications.

No license, express or implied, by estoppel or otherwise, to any intellectual property rights is granted by this document or by any conduct of Vishay. Product names and markings noted herein may be trademarks of their respective owners.

## Material Category Policy

**Vishay Intertechnology, Inc. hereby certifies that all its products that are identified as RoHS-Compliant fulfill the definitions and restrictions defined under Directive 2011/65/EU of The European Parliament and of the Council of June 8, 2011 on the restriction of the use of certain hazardous substances in electrical and electronic equipment (EEE) - recast, unless otherwise specified as non-compliant.**

**Please note that some Vishay documentation may still make reference to RoHS Directive 2002/95/EC. We confirm that all the products identified as being compliant to Directive 2002/95/EC conform to Directive 2011/65/EU.**

**Vishay Intertechnology, Inc. hereby certifies that all its products that are identified as Halogen-Free follow Halogen-Free requirements as per JEDEC JS709A standards. Please note that some Vishay documentation may still make reference to the IEC 61249-2-21 definition. We confirm that all the products identified as being compliant to IEC 61249-2-21 conform to JEDEC JS709A standards.**

## Данный компонент на территории Российской Федерации

### Вы можете приобрести в компании MosChip.

Для оперативного оформления запроса Вам необходимо перейти по данной ссылке:

<http://moschip.ru/get-element>

Вы можете разместить у нас заказ для любого Вашего проекта, будь то серийное производство или разработка единичного прибора.

В нашем ассортименте представлены ведущие мировые производители активных и пассивных электронных компонентов.

Нашей специализацией является поставка электронной компонентной базы двойного назначения, продукции таких производителей как XILINX, Intel (ex.ALTERA), Vicor, Microchip, Texas Instruments, Analog Devices, Mini-Circuits, Amphenol, Glenair.

Сотрудничество с глобальными дистрибьюторами электронных компонентов, предоставляет возможность заказывать и получать с международных складов практически любой перечень компонентов в оптимальные для Вас сроки.

На всех этапах разработки и производства наши партнеры могут получить квалифицированную поддержку опытных инженеров.

Система менеджмента качества компании отвечает требованиям в соответствии с ГОСТ Р ИСО 9001, ГОСТ РВ 0015-002 и ЭС РД 009

### Офис по работе с юридическими лицами:

105318, г.Москва, ул.Щербаковская д.3, офис 1107, 1118, ДЦ «Щербаковский»

Телефон: +7 495 668-12-70 (многоканальный)

Факс: +7 495 668-12-70 (доб.304)

E-mail: [info@moschip.ru](mailto:info@moschip.ru)

Skype отдела продаж:

moschip.ru

moschip.ru\_4

moschip.ru\_6

moschip.ru\_9