

TENTATIVE

All information in this technical data sheet is tentative
and subject to change without notice.

Preliminary

2.2" QVGA

TECHNICAL SPECIFICATION

T-55458GD022J-LW-A-AAN

OPTREX CORPORATION.

Date: May.7,'08

CONTENTS

No.	Item	Page
--	COVER	1
--	CONTENTS	2
1	APPLICATION	3
2	OVERVIEW	4
3	ABSOLUTE MAXIMUM RATINGS	5
4	ELECTRICAL CHARACTERISTICS	5, 6
5	INTERFACE PIN CONNECTION	7
6	RECOMMENDED SEQUENCE	8, 9, 10, 11, 12
7	DISPLAY POSITION AND SCAN DIRECTION	13
8	MECHANICAL SPECIFICATION	14
9	OPTICAL CHARACTERISTICS	15, 16, 17
10	RELIABILITY TEST CONDITION	18
11	OTHER FEATURE	19
12	HANDLING PRECAUTIONS FOR TFT-LCD MODULE	20, 21

1. APPLICATION

This specification applies to color TFT-LCD module, T-55458GD022J-LW-A-AAN.

These specification papers are the proprietary product of OPTREX CORPORATION (“OPTREX”) and include materials protected under copyright of OPTREX. No part of this document may be reproduced in any form or by any means without the express written permission of OPTREX.

OPTREX does not assume any liability for infringement of patents, copyrights or other intellectual property rights of third parties by or arising from use of a product specified in this document. No license, express, implied or otherwise, is granted under any patents, copyrights or other intellectual property rights of OPTREX or of others.

OPTREX classifies the usage of the TFT-LCD module as follows. Please confirm the usage before using the product.

(1) Standard Usage

Computers, office equipment, factory automation equipment, test and measurement equipment, communications, transportation equipment(automobiles, ships, trains, etc.), provided, however, that operation is not influenced by TFT-LCD directly.

(2) Special Usage

Medical equipment, safety equipment, transportation equipment, provided, however, that TFT-LCD is necessary to its operation.

(3) Specific Usage

Cockpit Equipment, military systems, aerospace equipment, nuclear reactor control systems, life support systems and any other equipment. OPTREX should make a contract that stipulate apportionment of responsibilities between OPTREX and our customer.

The product specified in this document is designed for “Standard Usage” unless otherwise specified in this document. If customers intend to use the product for applications other than those specified for “Standard Usage”, they should first contact OPTREX sales representative for it's intended use in writing.

OPTREX has been making continuous effort to improve the reliability of its products. Customers should implement sufficient reliability design of their application equipments such as redundant system design, fail-safe functions, anti-failure features.

OPTREX assumes no responsibility for any damage resulting from the use of the product that does not comply with the instructions and the precautions specified in this document.

Please contact and consult a OPTREX sales representative for any questions regarding this product.

2. OVERVIEW

T-55458GD022J-LW-A-AAN is 2.2" color TFT-LCD (Thin Film Transistor Liquid Crystal Display) module composed of LCD panel, driver ICs, control circuit, backlight unit.

240 × 320, 65k-color images are displayed on the 2.2" diagonal screen. Input power voltages are 3.0V for LCD and 1.8V for interface.

Driver circuit for LED backlight is not included in this module. General specifications are summarized in the following table:

ITEM	SPECIFICATION
Display Area (mm)	33.84(H) × 45.12(V) (2.2-inch diagonal)
Number of Dots	240 × 3 (H) × 320 (V)
Pixel Pitch (mm)	0.141 (H) × 0.141 (V)
Color Pixel Arrangement	RGB vertical stripe
Display Mode	Normally white TN
Number of Color	65k
Luminance (cd/m ²)	200
Wide Viewing Angle Technology	Optical compensation film
Viewing Angle (CR ≥ 10)	-65~65° (H) -50~70° (V)
Surface Treatment	Clear and hard-coating 2H
Electrical Interface	CMOS
Optimum Viewing Angle (Contrast ratio)	12 o'clock
Module Size (mm)	39.8(W) × 56.9(H) × 2.8(D) *)
Module Mass (g)	13
Backlight Unit	Edge-light, LED

*) W/O FPC

Sign "()" represents preliminary value. Characteristic value without any note is typical value.

3. ABSOLUTE MAXIMUM RATINGS

ITEM	SYMBOL	MIN.	MAX.	UNIT
Power Supply Voltage for LCD	VCC	-0.3	4.2	V
Power Supply Voltage for Interface	VCCIO	-0.3	6.0	V
Logic Input Voltage	VI	-0.3	VCCIO+0.3	V
Backlight (LED) Current	IF	--	30	mA
Operation Temperature (Panel) <small>Note 1,2)</small>	T _{op(Panel)}	-20	70	°C
Operation Temperature (Ambient) <small>Note 2)</small>	T _{op(Ambient)}	-20	70	°C
Storage Temperature <small>Note 2)</small>	T _{stg}	-20	80	°C

[Note]

1) Measured at the center of active area and at the center of panel back surface

2) Top, T_{stg} ≤ 40°C : 90%RH max. without condensation

Top, T_{stg} > 40°C : Absolute humidity shall be less than the value of 90%RH at 40°C without condensation.

4. ELECTRICAL CHARACTERISTICS

(1) TFT- LCD

Ambient Temperature : Ta = 25°C

ITEM	SYMBOL	MIN.	TYP.	MAX.	UNIT	Remarks
Power Supply Voltage for LCD	VCC	2.7	3.0	3.3	V	
Power Supply Voltage for Interface	VCCIO	1.65	1.8	3.3	V	
Power Supply Current for LCD	ICC	--	5.6	7.5	mA	*)
Power Supply Current for Interface	ICCIO	--	0.005	0.006	mA	*)
Logic Input Voltage	High	VIH	0.8×VCCIO	--	V	
	Low	VIL	--	---	0.2×VCCIO	V

*) Display image at typical power supply current value is at VCC = +3.0V, VCCIO = +1.8 V, f_H=19 kHz, f_V=60 Hz CPU I/F, and 64-gray-bar pattern (6 bit).

(2) Backlight

ITEM	SYMBOL	MIN.	TYP.	MAX.	UNIT	Remarks
LED Voltage	VF	--	(9.6)	10.5	V	IF = 20 mA, Ta = 25°C
		--	--	(10.8)	V	IF = 20 mA, Ta = 0°C
		--	--	(11.0)	V	IF = 20 mA, Ta = -20°C
LED Current	IF	--	15.0	20.0	mA	*)1, *)2)

[Note]

*1) Constant Current Drive

*2) Lamp Current measurement method

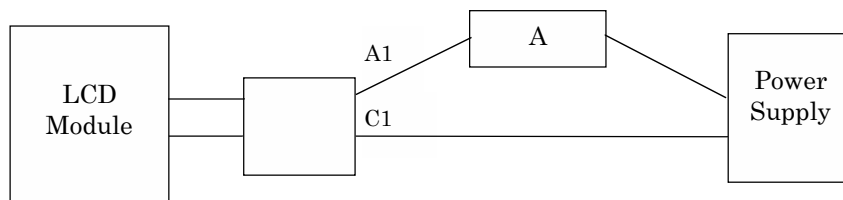

Diode IF-Ta CHARACTERISTICS DIAGRAM

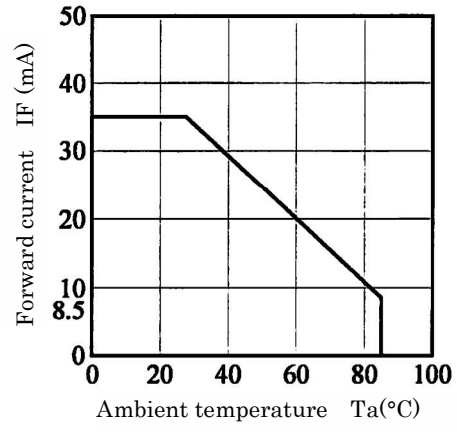

5. INTERFACE PIN CONNECTION

TER2 (Interface Signal)

Corresponding connector: FH27-40S-0.4SH(05) (HRS)

Pin No.	Pin Name
1	LED-
2	LED+
3	VCC
4	GND
5	D0
6	D1
7	D2
8	D3
9	D4
10	D5
11	D6
12	D7
13	D8
14	D9
15	D10
16	D11
17	D12
18	D13
19	D14
20	D15
21	GND
22	GND
23	SI
24	GND
25	SCL
26	GND
27	CS
28	RESET
29	RS
30	WR
31	RD
32	VSYNC
33	HSYNC
34	GND
35	DOTCLK
36	GND
37	PSX
38	IF_SHARE
39	VCCIO
40	GND

6. RECOMMENDED SEQUENCE

(1) Power ON Sequence (CPU I/F)

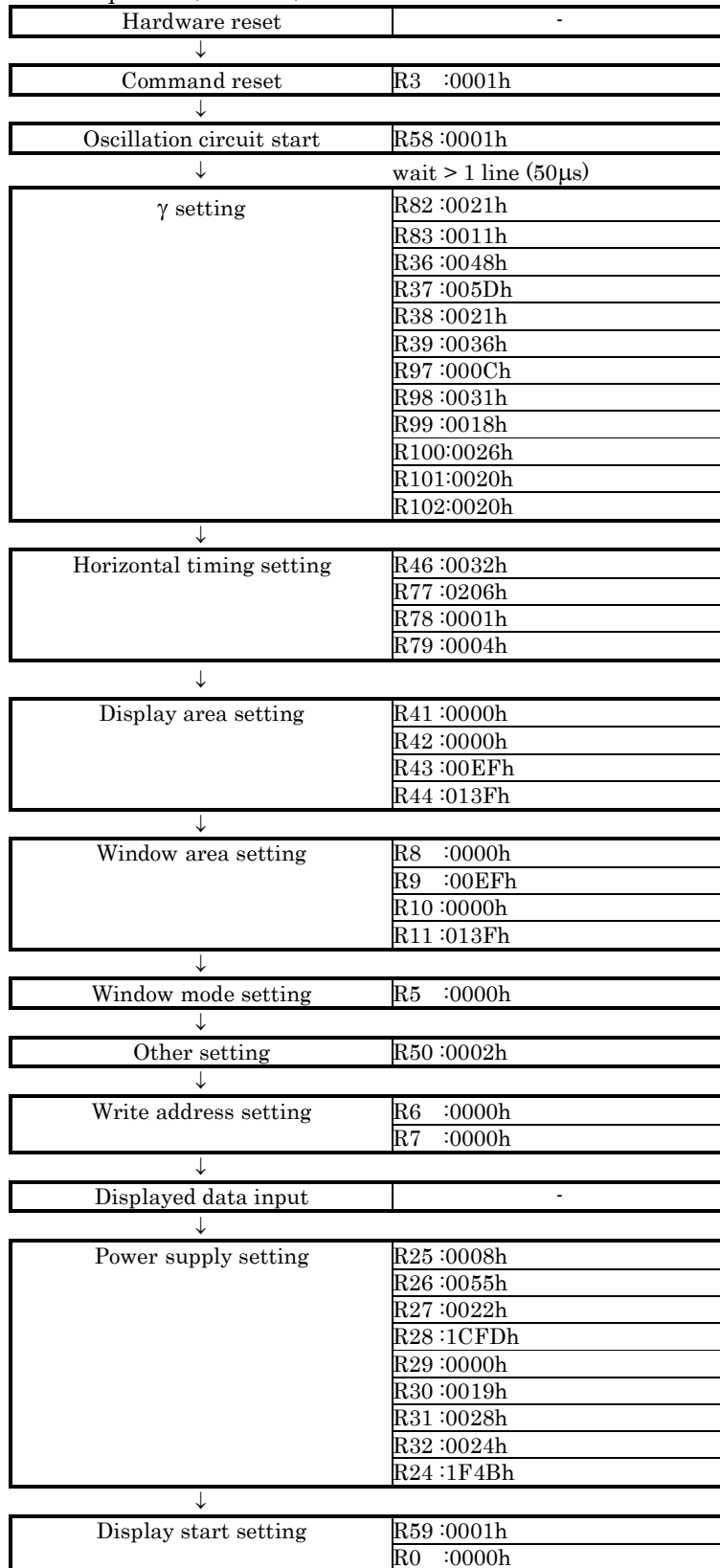

(2) Power ON Sequence (RGB I/F)

Setting Item	(Through mode) Register setting	(Capture mode) Register setting
Hardware reset	-	-
↓		
Command reset	R3 :0001h	R3 :0001h
↓		
Oscillation circuit start	R58 :0001h	R58 :0001h
↓	wait > 1 line (50μs)	
γ setting	R82 :0021h	R82 :0021h
	R83 :0011h	R83 :0011h
	R36 :0048h	R36 :0048h
	R37 :005Dh	R37 :005Dh
	R38 :0021h	R38 :0021h
	R39 :0036h	R39 :0036h
	R97 :000Ch	R97 :000Ch
	R98 :0031h	R98 :0031h
	R99 :0018h	R99 :0018h
	R100:0026h	R100:0026h
R101:0020h	R101:0020h	
R102:0020h	R102:0020h	
↓		
RGB I/F Setting	R2 :0005h *)	R2 :0007h *)
	R60 :0000h	R60 :0000h
	R61 :013Fh	R61 :013Fh
	R62 :0021h *)	R62 :0021h *)
	R112:0020h *)	R63 :0000h
		R64 :00EFh
		R65 :0000h
		R66 :013Fh
	R112:0020h *)	
↓		
Horizontal timing setting	R46 :003Bh	R46 :003Bh
	R77 :0206h	R77 :0206h
	R78 :0001h	R78 :0001h
	R79 :0004h	R79 :0004h
↓		
Display area setting	R41 :0000h	R41 :0000h
	R42 :0000h	R42 :0000h
	R43 :00EFh	R43 :00EFh
	R44 :013Fh	R44 :013Fh
↓		
Other setting	R50 :0002h	R50 :0002h
↓		
Write address setting		R6 :0000h
		R7 :0000h
↓		
Display data input	-	-
↓		
Power supply setting	R25 :0008h	R25 :0008h
	R26 :0055h	R26 :0055h
	R27 :0022h	R27 :0022h
	R28 :1CFDh	R28 :1CFDh
	R29 :0000h	R29 :0000h
	R30 :0019h	R30 :0019h
	R31 :0028h	R31 :0028h
	R32 :0024h	R32 :0024h
	R24 :1F4Bh	R24 :1F4Bh
↓		
Display start setting	R59 :0001h	R59 :0001h
	R0 :0000h	R0 :0000h

*) Please set it in conformity to a signal of the system side.

(3) Power OFF Sequence

(CPU I/F and RGB I/F)

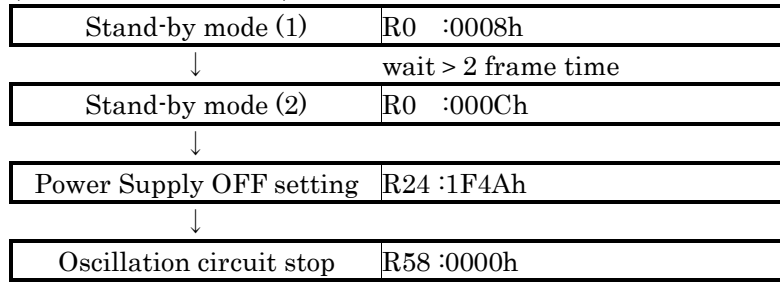

Setting Voltage

VGM=5.0V

VR=5.0V

VS=5.2V

RVDD=2.3V

VCOMp-p=5.0V

VCOMC=1.57V

VGH=VR × 3=15V

VGL=VR × (-2)+VCL=-12.7~13.3V

(4) Timing Specification

See: Data sheet of Driver IC (uPD161704A (NEC))

CPU I/F

Ta = 25°C

ITEM	SYMBOL	MIN.	TYP.	MAX.	UNIT
Address Set up Time	tAS	0	-	-	ns
Address Hold Time	tAH	20	-	-	ns
System Cycle Time (Writing)	tCYCW	60	-	-	ns
System Cycle Time (Reading)	tCYCR	400	-	-	ns
/WR Low Width	tCCLW	25	-	-	ns
/WR High Width	tCCHW	25	-	-	ns
/RD Low Width	tCCLR	200	-	-	ns
/RD High Width	tCCHR	80	-	-	ns
Data Set up Time	tDS	40	-	-	ns
Data Hold Time	tDH	0	-	-	ns
/CS Setup Time	tCSS	75	-	-	ns
/CS Hold Time	tCSH	0	-	-	ns
/RD Access Time	tACC	-	-	200	ns
Output Disable Time	tOH	-	-	100	ns

RGB I/F

Ta = 25°C

ITEM	SYMBOL	MIN.	TYP.	MAX.	UNIT	
DCLK	Frequency	fclk	-	4.96	7.14	MHz
	Period	tclk	140	-	-	ns
	Low Width	tclkl	70	-	-	ns
	High Width	tclkh	70	-	-	ns
DATA /HSYNC	Set up time	tDS	60	-	-	ns
	Hold time	tDH	60	-	-	ns
HSYNC	Horizontal Active Time		240	240	240	tCLK
	Horizontal Back Porch *1)	tHBP	1	4	-	tCLK
	Pulse Width	tHSW	1	4	-	tCLK
VSYNC	Frequency	fV	55	60	75	Hz
	Period	tV	13.3	16.7	18.2	ms
	Vertical Active Time		320	320	320	tH
	Vertical Back Porch *1)	tVBP	1	1	-	tH
	Pulse Width	tVSW	1	1	-	tH

*1) W/O Pulse width

Serial I/F

Ta = 25°C

ITEM		SYMBOL	MIN.	TYP.	MAX.	UNIT
Serial Clock Cycle		tSCYC	66	-	-	ns
SCL Low Width		tSLW	20	-	-	ns
SCL High Width		tSHW	20	-	-	ns
Address Set up Time		tSAS	10	-	-	ns
Address Hold Time		tSAH	20	-	-	ns
Data Set up Time		tSDAS	10	-	-	ns
Data Hold Time		tSDH	20	-	-	ns
CS-SCL Time	Set up Time	TCSS	20	-	-	ns
	Hold Time	TCSH	20	-	-	ns

7. DISPLAY POSITION AND SCAN DIRECTION

D(X,Y) shows the data number of input signal for LCD panel signal processing PCB.

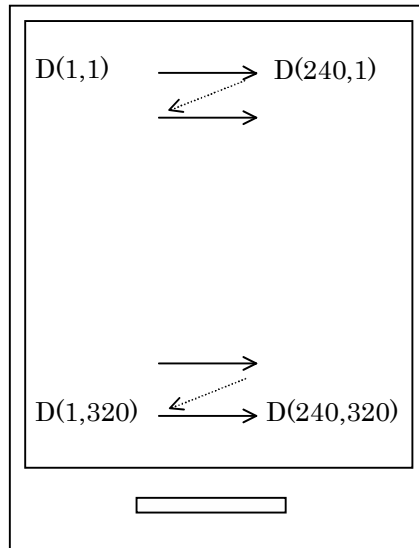

8. MECHANICAL SPECIFICATIONS

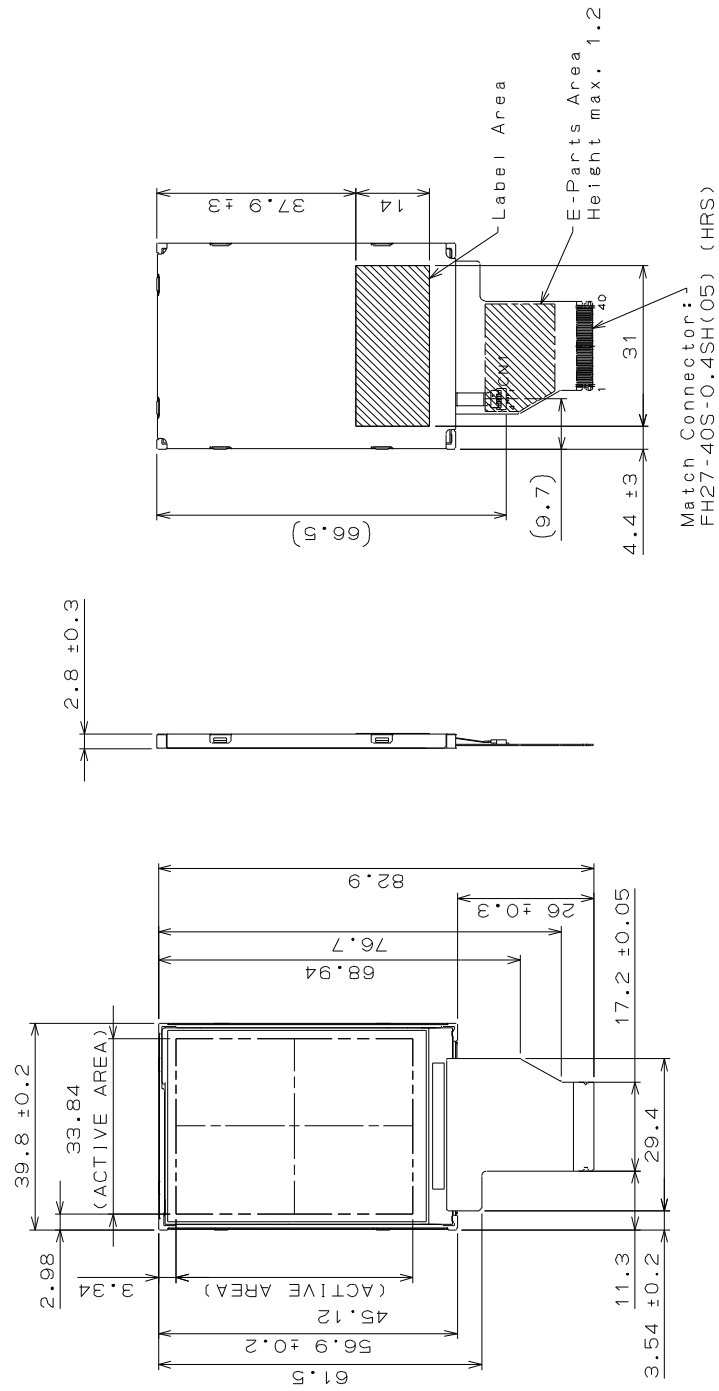

AA022QH05

1) Tolerance is ±0.5mm unless noted.
2) Third angle projection.

CN1: FH19C-4S-0.5SH(05) (HRS)

(Unit:mm)

9. OPTICAL CHARACTERISTICS

Ta=25°C, VCC=3.0V, VCCIO=1.8V, Input Signals: Typ. Values shown in Section 6

ITEM		SYMBOL	CONDITION	MIN.	TYP.	MAX.	UNIT	Remarks
Contrast Ratio		CR	$\theta_V=0^\circ, \theta_H=0^\circ$	200	300	--	--	*1)*2)*4)
Luminance		Lw	$\theta_V=0^\circ, \theta_H=0^\circ$	150	200	--	cd/m ²	*1)*4)
Response Time		tr	$\theta_V=0^\circ, \theta_H=0^\circ$	--	10	--	ms	*1)*3)*4)
		tf	$\theta_V=0^\circ, \theta_H=0^\circ$	--	25	--	ms	*1)*3)*4)
Viewing Angle	Horizontal	θ_H	CR \geq 10	-50~50	-65~65	--	--	*1)*4)
	Vertical	θ_V		-30~50	-50~70	--	--	*1)*4)
Image Sticking		tis	2 h	--	--	2	s	*5)
Color Coordinates	Red	Rx	$\theta_V=0^\circ, \theta_H=0^\circ$	(0.595)	(0.645)	(0.695)	--	*1)*4)
		Ry		(0.295)	(0.345)	(0.395)		
	Green	Gx		(0.279)	(0.329)	(0.379)		
		Gy		(0.576)	(0.626)	(0.676)		
	Blue	Bx		(0.104)	(0.154)	(0.204)		
		By		(0.001)	(0.051)	(0.101)		
White	Wx	(0.260)	(0.310)	(0.360)				
	Wy	(0.265)	(0.315)	(0.365)				

[Note]

These items are measured using CS1000(MINOLTA) for color coordinates, EZContrast(ELDIM) for viewing angle and CS1000 or BM-5A(TOPCON) for others under the dark room condition (no ambient light) after more than 30 minutes from turning on the lamp unless noted.

Condition: IL=15.0 mA

Measurement method for luminance and color coordinates is as follows.

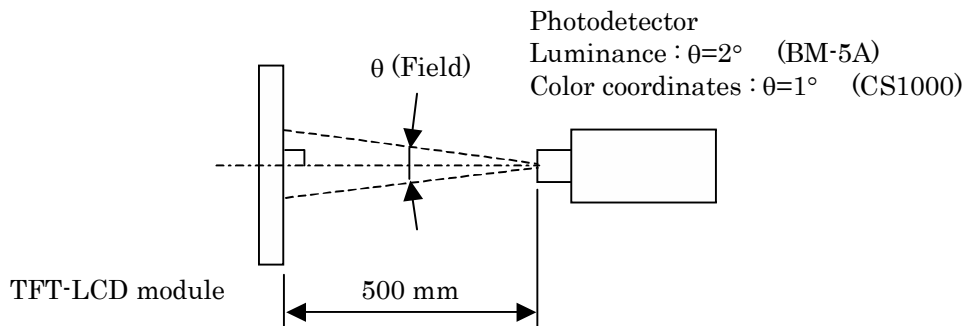

The luminance is measured according to FLAT PANEL DISPLAY MEASUREMENTS STANDARD (VESA Standard).

*1) Measurement Point

Contrast Ratio, Luminance, Response Time, Viewing Angle, Color Coordinates: Display Center

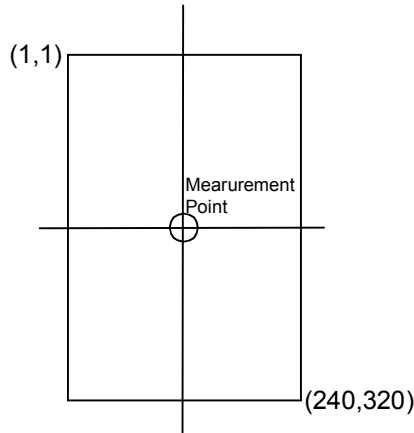

*2) Definition of Contrast Ratio

CR=Luminance with all white pixels / Luminance with all black pixels

*3) Definition of Response Time

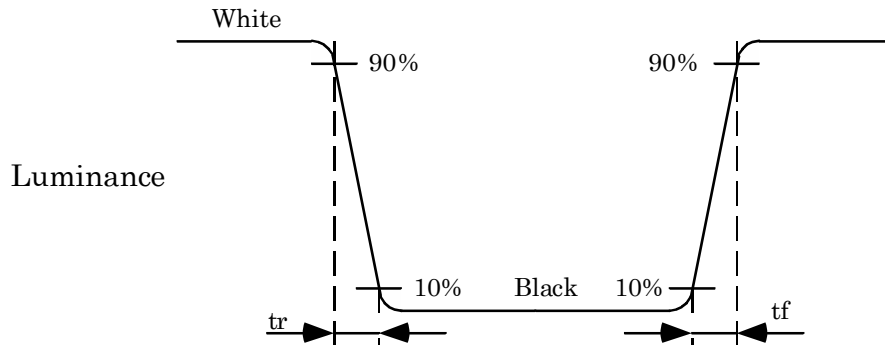

*4) Definition of Viewing Angle (θ_v , θ_H)

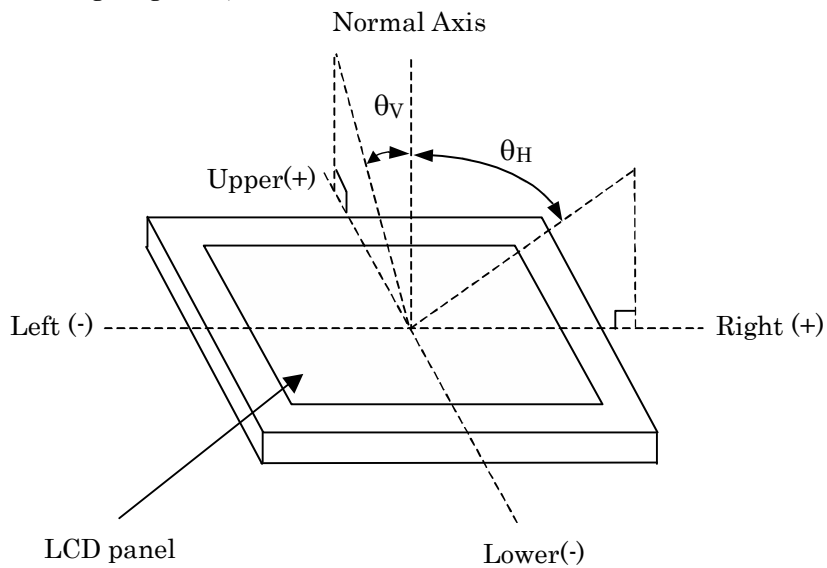

*5) Image Sticking

Continuously display the test pattern shown in the figure below for two-hours. Then display a completely white screen. The previous image shall not persist more than two seconds at 25°C.

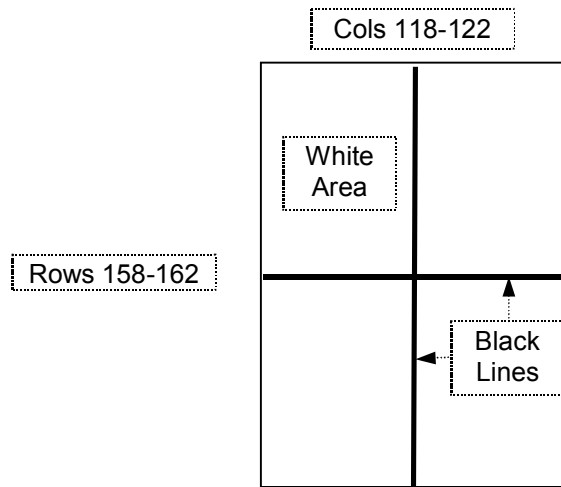

TEST PATTERN FOR IMAGE STICKING TEST

10. RELIABILITY TEST CONDITION

(1) Temperature and Humidity

ITEM	CONDITIONS
HIGH TEMPERATURE HIGH HUMIDITY OPERATION	40°C, 90%RH, 240 h (No condensation)
HIGH TEMPERATURE OPERATION	70°C, 240 h
LOW TEMPERATURE OPERATION	-20°C, 240 h
HIGH TEMPERATURE STORAGE	80°C, 240 h
LOW TEMPERATURE STORAGE	-20°C, 240 h
THERMAL SHOCK (NON-OPERATION)	BETWEEN -20°C (1h) and 80°C(1h), 100 CYCLES

(2) Shock & Vibration

ITEM	CONDITIONS
SHOCK (NON-OPERATION)	Shock level: 1470m/s ² (150G) Waveform: half sinusoidal wave, 2ms Number of shocks: one shock input in each direction of three mutually perpendicular axis for a total of six shock inputs
VIBRATION (NON-OPERATION)	Vibration level: 9.8m/s ² (1.0G) Waveform: sinusoidal Frequency range: 5 to 500Hz Frequency sweep rate: 0.5 octave /min Duration: one sweep from 5 to 500 Hz in each of three mutually perpendicular axis(total 3 hours)

(3) Judgment standard

The judgment of the above tests should be made as follow:

Pass: Normal display image, no damage of the display function. (ex. no line defect)

Partial transformation of the module parts should be ignored.

Fail: No display image, damage of the display function. (ex. line defect)

11. OTHER FEATURE

This LCD module complies with RoHS*) directive.

*) RoHS: Restriction of the use of certain hazardous substances in electrical and electronic equipment

12. HANDLING PRECAUTIONS FOR TFT-LCD MODULE

Please pay attention to the followings in handling TFT-LCD products;

(1) ASSEMBLY PRECAUTION

- a. Please do not bending or wrenching LCD in assembling. And please do not drop, bend or twist LCD module in handling.
- b. Please design display housing in accordance with the following guide lines.
 - (a) Housing case must be designed carefully so as not to put stresses on LCD all sides and not to wrench module. The stresses may cause non-uniformity even if there is no non-uniformity statically.
 - (b) Under high temperature environment, performance and life time of LED may heavily shorten. When you design with our LCD product, please consider radiating heat and ventilation for good heat management.
 - (c) Keep sufficient clearance between LCD module back surface and housing when the LCD module is mounted. Approximately 1.0mm of the clearance in the design is recommended taking into account the tolerance of LCD module thickness and mounting structure height on the housing.
 - (d) When some parts, such as, FPC cable and ferrite plate, are installed underneath the LCD module, still sufficient clearance is required, such as 0.5mm. This clearance is, especially, to be reconsidered when the additional parts are implemented for EMI countermeasure.
 - (e) Design the LED driver location and connector position carefully so as not to give stress to LED cable.
 - (f) Keep sufficient clearance between LCD module and the others parts, such as inverter and speaker so as not to interface the LCD module. Approximately 1.0mm of the clearance in the design is recommended.
 - (g) To avoid local elevation/decrease of temperature, considering location of heating element, heat release, thermal design should be done.
- c. Please do not push or scratch LCD panel surface with anything hard. And do not soil LCD panel surface by touching with bare hands. (Polarizer film, surface of LCD panel is easy to be flawed.)
- d. Please do not press any parts on the rear side such as source TCP, gate TCP, control circuit board and FPCs during handling LCD module. If pressing rear part is unavoidable, handle the LCD module with care not to damage them.
- e. Please wipe off LCD panel surface with absorbent cotton or soft cloth in case of it being soiled.
- f. Please wipe off drops of adhesives like saliva and water on LCD panel surface immediately. They might damage to cause panel surface variation and color change.
- g. Please do not take a LCD module to pieces and reconstruct it. Resolving and reconstructing modules may cause them not to work well.
- h. Please do not touch metal frames with bare hands and soiled gloves. A color change of the metal frames can happen during a long preservation of soiled LCD modules.
- i. Please handle metal frame carefully because edge of metal frame is very sharp.
- j. Please connect the metal frame of LCD module to GND in order to minimize the effect of external noise and EMI.
- k. Be sure to connect the cables and the connectors correctly.

(2) OPERATING PRECAUTIONS

- a. Please be sure to turn off the power supply before connecting and disconnecting signal input cable.
- b. The interface signal speed is very high. Please pay attention to transmission line design and other high speed signal precautions to satisfy signal specification.
- c. A condensation might happen on the surface and inside of LCD module in case of sudden change of ambient temperature.
- d. Please pay attention not to display the same pattern for very long time. Image might stick on

- LCD. Even if image sticking happens, it may disappear as the operation time proceeds.
- e. Please obey the same safe instructions as ones being prepared for ordinary electronic products.

(3) PRECAUTIONS WITH ELECTROSTATICS

- a. This LCD module use CMOS-IC on circuit board and TFT-LCD panel, and so it is easy to be affected by electrostatics. Please be careful with electrostatics by the way of your body connecting to the ground and so on.
- b. Please remove protection film very slowly from the surface of LCD module to prevent from electrostatics occurrence.

(4) STORAGE PRECAUTIONS

- a. Please do not leave the LCDs in the environment of high humidity and high temperature such as 60°C/90%RH.
- b. Please do not leave the LCDs in the environment of low temperature; below -20°C.

(5) SAFETY PRECAUTIONS

- a. When you waste damaged or unnecessary LCDs, it is recommended to crush LCDs into pieces and wash them off with solvents such as acetone and ethanol, which should later be burned.
- b. If any liquid leaks out of a damaged glass cell and comes in contact with the hands, wash off thoroughly with soap and water.
- c. Be sure to turn off the power supply when inserting or disconnecting the cable.
- d. LED driver should be designed carefully to limit or stop it's function when LED over current is detected on the LED cable.

(6) OTHERS

- a. A strong incident light into LCD panel might cause display characteristics changing inferior because of polarizer film, color filter, and other materials becoming inferior. Please do not expose LCD module direct sunlight and strong UV rays.
- b. Please pay attention to a panel side of LCD module not to contact with other materials in preserving it alone.
- c. For the packaging box, please pay attention to the followings;
 - (a) Packaging box and inner case for LCD are designed to protect the LCDs from the damage or scratching during transportation. Please do not open except picking LCDs up from the box.
 - (b) Please do not pile them up more than TBD boxes. (They are not designed so.) And please do not turn over.
 - (c) Please handle packaging box with care not to give them sudden shock and vibrations. And also please do not throw them up.
 - (d) Packaging box and inner case for LCDs are made of cardboard. So please pay attention not to get them wet. (Such like keeping them in high humidity or wet place can occur getting them wet.)

Данный компонент на территории Российской Федерации

Вы можете приобрести в компании MosChip.

Для оперативного оформления запроса Вам необходимо перейти по данной ссылке:

<http://moschip.ru/get-element>

Вы можете разместить у нас заказ для любого Вашего проекта, будь то серийное производство или разработка единичного прибора.

В нашем ассортименте представлены ведущие мировые производители активных и пассивных электронных компонентов.

Нашей специализацией является поставка электронной компонентной базы двойного назначения, продукции таких производителей как XILINX, Intel (ex.ALTERA), Vicor, Microchip, Texas Instruments, Analog Devices, Mini-Circuits, Amphenol, Glenair.

Сотрудничество с глобальными дистрибьюторами электронных компонентов, предоставляет возможность заказывать и получать с международных складов практически любой перечень компонентов в оптимальные для Вас сроки.

На всех этапах разработки и производства наши партнеры могут получить квалифицированную поддержку опытных инженеров.

Система менеджмента качества компании отвечает требованиям в соответствии с ГОСТ Р ИСО 9001, ГОСТ РВ 0015-002 и ЭС РД 009

Офис по работе с юридическими лицами:

105318, г.Москва, ул.Щербаковская д.3, офис 1107, 1118, ДЦ «Щербаковский»

Телефон: +7 495 668-12-70 (многоканальный)

Факс: +7 495 668-12-70 (доб.304)

E-mail: info@moschip.ru

Skype отдела продаж:

moschip.ru

moschip.ru_4

moschip.ru_6

moschip.ru_9