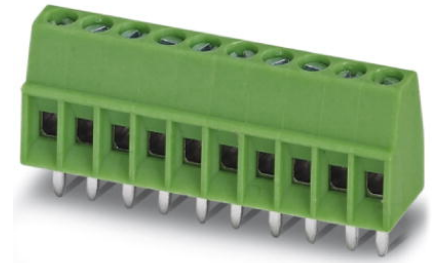

MPT 0,5/12-2,54

Order No.: 1725753

The figure shows a 10-position version of the product

<http://eshop.phoenixcontact.de/phoenix/treeViewClick.do?UID=1725753>

PC terminal block, Nominal current: 6 A, Nom. voltage: 63 V, Pitch: 2.54 mm, Number of positions: 12, Type of connection: Screw connection, Assembly: Soldering, Conductor/PCB connection direction: 0 °, Color: green

Commercial data

EAN	4017918116354
Pack	50 pcs.
Customs tariff	85369010
Weight/Piece	0.003482 KG
Catalog page information	Page 51 (CC-2009)

Product notes

WEEE/RoHS-compliant since:
01/01/2003



<http://www.download.phoenixcontact.com>
Please note that the data given here has been taken from the online catalog. For comprehensive information and data, please refer to the user documentation. The General Terms and Conditions of Use apply to Internet downloads.

Technical data

Dimensions / positions

Length	6.2 mm
Pitch	2.54 mm
Dimension a	27.94 mm

Number of positions	12
Pin dimensions	0,5 x 0,9 mm
Hole diameter	1.1 mm
Screw thread	M1,6
Tightening torque, min	0.12 Nm
Tightening torque max	0.15 Nm

Technical data

Insulating material group	I
Rated surge voltage (III/3)	1.5 kV
Rated surge voltage (III/2)	1.5 kV
Rated surge voltage (II/2)	2.5 kV
Rated voltage (III/2)	160 V
Rated voltage (II/2)	320 V
Connection in acc. with standard	EN-VDE
Nominal current I_N	6 A
Nominal voltage U_N	63 V
Nominal cross section	0.5 mm ²
Maximum load current	6 A
Insulating material	PA
Inflammability class acc. to UL 94	V0
Stripping length	4.5 mm

Connection data

Conductor cross section solid min.	0.14 mm ²
Conductor cross section solid max.	0.5 mm ²
Conductor cross section stranded min.	0.14 mm ²
Conductor cross section stranded max.	0.5 mm ²
Conductor cross section stranded, with ferrule without plastic sleeve min.	0.25 mm ²
Conductor cross section stranded, with ferrule without plastic sleeve max.	0.34 mm ²
Conductor cross section stranded, with ferrule with plastic sleeve min.	0.25 mm ²
Conductor cross section stranded, with ferrule with plastic sleeve max.	0.34 mm ²
Conductor cross section AWG/kcmil min.	26
Conductor cross section AWG/kcmil max	20

2 conductors with same cross section, solid min.	0.14 mm ²
2 conductors with same cross section, solid max.	0.34 mm ²
2 conductors with same cross section, stranded min.	0.14 mm ²
2 conductors with same cross section, stranded max.	0.34 mm ²

Certificates / Approvals



Certification CSA, CUL, UL

CSA

Nominal voltage U_N	125 V
Nominal current I_N	6 A
AWG/kcmil	28-20

CUL

Nominal voltage U_N	125 V
Nominal current I_N	6 A
AWG/kcmil	30-20

UL

Nominal voltage U_N	125 V
Nominal current I_N	6 A
AWG/kcmil	30-20

Accessories

Item	Designation	Description
------	-------------	-------------

Marking

0804853	SK 2,54/2,8:FORTL.ZAHLEN	Marker card, printed horizontally, self-adhesive, 10-section marker strip, 14 identical decades marked 1-10, 11-20 etc. up to 91-100, sufficient for 140 terminal blocks
---------	--------------------------	--

Tools

1205202	SZS 0,4X2,0	Screwdriver, bladed, matches all screw terminal blocks up to 1.5 mm ² connection cross section, blade width: 2.5 mm, without approvals
---------	-------------	---

Diagrams/Drawings

Drilling plan/solder pad geometry

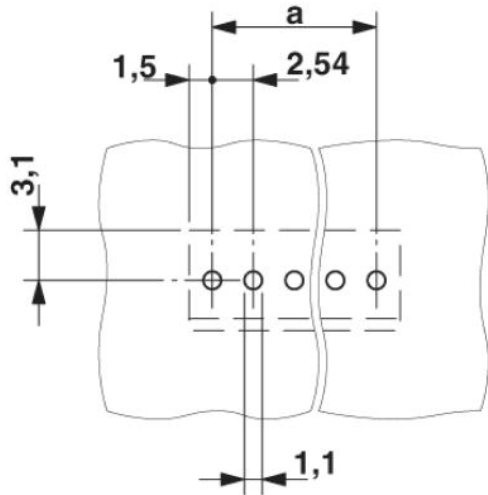

Dimensioned drawing

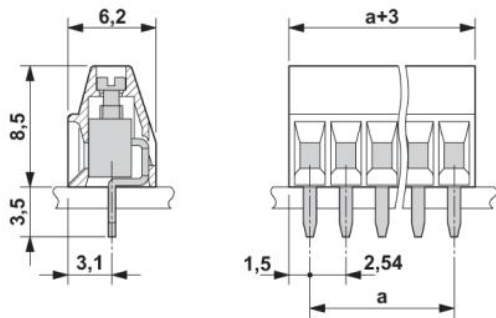

Address

PHOENIX CONTACT Deutschland GmbH
Flachmarktstr. 8
32825 Blomberg, Germany
Phone +49 5235 3 12000
Fax +49 5235 3 41200
<http://www.phoenixcontact.de>



© 2010 Phoenix Contact
Technical modifications reserved;

Данный компонент на территории Российской Федерации

Вы можете приобрести в компании MosChip.

Для оперативного оформления запроса Вам необходимо перейти по данной ссылке:

<http://moschip.ru/get-element>

Вы можете разместить у нас заказ для любого Вашего проекта, будь то серийное производство или разработка единичного прибора.

В нашем ассортименте представлены ведущие мировые производители активных и пассивных электронных компонентов.

Нашей специализацией является поставка электронной компонентной базы двойного назначения, продукции таких производителей как XILINX, Intel (ex.ALTERA), Vicor, Microchip, Texas Instruments, Analog Devices, Mini-Circuits, Amphenol, Glenair.

Сотрудничество с глобальными дистрибьюторами электронных компонентов, предоставляет возможность заказывать и получать с международных складов практически любой перечень компонентов в оптимальные для Вас сроки.

На всех этапах разработки и производства наши партнеры могут получить квалифицированную поддержку опытных инженеров.

Система менеджмента качества компании отвечает требованиям в соответствии с ГОСТ Р ИСО 9001, ГОСТ РВ 0015-002 и ЭС РД 009

Офис по работе с юридическими лицами:

105318, г.Москва, ул.Щербаковская д.3, офис 1107, 1118, ДЦ «Щербаковский»

Телефон: +7 495 668-12-70 (многоканальный)

Факс: +7 495 668-12-70 (доб.304)

E-mail: info@moschip.ru

Skype отдела продаж:

moschip.ru

moschip.ru_4

moschip.ru_6

moschip.ru_9