



FEATURES

- 3rd ed. medical and ITE safety approved
- 250W compact high density
- 3" x 5" standard footprint
- High efficiency up to 94%
- Remote sense
- Remote On/Off, Power OK (MVAC250-xxAFD)
- Universal AC input with active PFC
- Less than 1U high – 1.4"
- Convection cooled operation up to 170W
- Isolated 12V@1A fan output
- Isolated 5V@2A standby output with current share model MVAC250-xxAFD
- RoHS compliant
- Active inrush protection
- Current sharing option

DESCRIPTION

The MVAC250 series switching power supplies utilize advanced component and circuit technologies to deliver high efficiency. Designed for medical, computing, communications, telecom and other OEM applications to satisfy 1U height design considerations, the MVAC250 Series measures only 3.0" x 5.0" x 1.40". All models offer universal AC input with active power factor correction (PFC) and compliance to worldwide safety and EMC standards.



Available now at www.murata-ps.com/en/3d/acdc.html



ORDERING GUIDE

Model Number*	Natural Convection Cooling	Forced Air Cooling	Main Output (V1)	Fan Output (V2)	Aux Output (V3)
	MVAC250-12F	170W	250W @ 250LFM	12V	12V
MVAC250-24F	24V			12V	
MVAC250-48F	50V			12V	
MVAC250-xxAFD	These models also include aux output (V3)				5V

* Refer to page 2 for current sharing model numbers MVAC250-xxAFD

INPUT CHARACTERISTICS

Parameter	Conditions	Min.	Typ.	Max.	Units
Input Voltage Operating Range*	Single phase	90	115/230	264	Vac
Input Frequency		47	50/60	63	Hz
Turn-on Input Voltage	Input rising	80		90	Vac
Turn-off Input Voltage	Input falling	70		80	
Input Current	90Vac input, full load all outputs			3.4	A
No Load Input Power (MVAC250-xxAFD)*	(PS_ON = OFF, 5V_Aux = 0A)	1.5		2.0	W
Inrush Current	At 264Vac, at 25°C cold start		15		Apk
Power Factor	At 230Vac, full load		0.96		

*DC Input 127-300Vdc optionally available; contact your Murata salesperson.

OUTPUT CHARACTERISTICS

Model Number	Main Output Voltage (V1)	Load Current	Maximum Load Capacitance	Line, Load, Cross Regulation	Typical Efficiency @230Vac
MVAC250-12F	12V	0.4 to 20.8A	0 to 1500µF	± 1%	93%
MVAC250-24F	24V	0.2 to 10.4A	0 to 300µF	± 1%	93%
MVAC250-48F	50V	0.1 to 5.0A	0 to 82µF	± 1%	94%
MVAC250-12AFD	12V @ 10.4A ⁶	0 to 20.8A	0 to 1500µF	± 1.5% ⁶	93%
MVAC250-24AFD	24V @ 5.2A ⁶	0 to 10.4A	0 to 300µF	± 1.5% ⁶	93%
MVAC250-48AFD	50V @ 2.5A ⁶	0 to 5.0A	0 to 82µF	± 1.5% ⁶	94%

Main Output Characteristics (all models)

Parameter	Conditions	Typ.	Max.	Units
Transient Response	50% load step, 1A/µsec slew rate		± 5	%
Settling Time to 1% of Nominal			500	µsec
Turn On Delay	After application of input power		3	sec
Output Voltage Rise	Monotonic ⁵		50	msec
Output Holdup	120Vac/60Hz, full load	20		
Temperature Coefficient			0.02	%/°C
Ripple Voltage & Noise ¹			1	%
Remote Sense	Compensates for up to 0.5V of lead drop with remote sense connected. Protected against short circuit and reverse connection.		500	mV

Auxiliary Output Characteristics (varies by model)

Auxiliary Output	Aux Output Voltage ⁸	Load Current	Load Capacitance	Line, Load, Cross Regulation ³	Ripple Voltage & Noise ¹
Fan (V2) all models	12V	0 to 1A	0 to 220µF	± 10%	2%
Aux (V3) – MVAC250-xxAFD	5V	0 to 2A	0 to 220µF	± 5%	1%

1. Noise and ripple is measured at an oscilloscope jack on the output, 20MHz bandwidth, and with 0.1µF ceramic and 10µF aluminum electrolytic capacitors across the output pins.
2. Unless otherwise specified all measurements are taken at 120Vac input and 25°C ambient temperature.
3. Fan (V2) regulation band applies from 0.1A to 1A load with a minimum of 10W load on the main (V1) output.
4. Fan (V2) has overvoltage protection (tracking V1) and short circuit protection. Overloading the Fan (V2) output can result in permanent damage to the unit.
5. 24V and 50V models may exhibit up to 5% turn on overshoot for loads less than 4% of full load.
6. See current sharing option section for droop characteristics.
7. No load Input power varies by model and by input line. Measurement is difficult to make due to burst mode operation. Please contact Murata sales if additional information is required.
8. All three output returns are isolated from each other (see isolation characteristics section); the returns may be tied together externally.

ENVIRONMENTAL CHARACTERISTICS					
Parameter	Conditions	Min.	Typ.	Max.	Units
Storage Temperature Range		-40		85	°C
Operating Temperature Range	See power rating curves	-10		70	
	Start up	-20			
Operating Humidity	Non-condensing	10		95	%
Operating Altitude		-200		3000	m
MTBF	Telcordia SR-332 M1C3 @25°C	474K			Hours
Shock	Operating, MIL-HBK-810E	Complies			
	Non-operating, MIL-HBK-810E	Complies			
Operational Vibration	IEC-68-2-27 standard	Complies to levels of IEC721-3-2			
Safety	IEC60950-1:2006/A11:2009 UL60950-1 2nd Ed. 2007-03-27, CSA22.2 No.60950-1 2nd Ed. 2007.03, EN60690-1:2006+A11:2009 (Pending) IEC60601-1 Ed. 3 MOOP ANSI/AAMI ES60601-1 (2005+C1:09+A2:10), CSA 22.2 No. 60601-1 (2008) 3rd Edition MOOP EN60601-1:2006 3rd ed. MOOP (Pending) CE Marking per LVD				
Warranty	2 years				
Outside Dimensions	3.0" x 5.0" x 1.4" (76.2mm x 127mm x 35.6mm)				
Weight	MVAC250-xxF: 0.73 lbs (332.9g); MVAC250-xxAFD: 0.76 lbs (344.7g)				

RESIDUAL RISK (PER ISO 14971 & IEC60601-1) FOR USER CONSIDERATION	
Fault Condition	Residual Risk
Complies	Contact your Murata salesperson for details

PROTECTION CHARACTERISTICS					
Parameter	Conditions	Min.	Typ.	Max.	Units
Over Voltage Protection ⁴	V1 (main output) latching	110		125	%
	V3 (aux output: MVAC250-xxAFD) latching	5.5		7.5	V
Over Current Protection ⁴	V1, hiccup mode	110		130	%Amax
Over Temperature Protection	Auto-recovery		Complies		
Remote Sense Short Circuit Protection			Complies		
Remote Sense Reverse Connection Protection			Complies		

ISOLATION CHARACTERISTICS					
Parameter	Conditions	Min.	Typ.	Max.	Units
Isolation	Primary to Chassis	1500			Vac
	Primary to Secondary	3000			
	Secondary to Chassis	500			
	Output to Output	500			
Earth Leakage Current (under single fault condition)	MVAC250-xxAFD: 264Vac, 60Hz, 25°C		300		µA
	MVAC250-xxF: 264Vac, 60Hz, 25°C		350		
Earth Leakage Current (under normal conditions)	MVAC250-xxAFD: 264Vac, 60Hz, 25°C		150		
	MVAC250-xxF: 264Vac, 60Hz, 25°C		250		

CURRENT SHARING OPTION – MVAC250-xxAFD ONLY	
Model Number	Description
MVAC250-12AFD	<p>Current Sharing Notes:</p> <p>Main Output: Current share is achieved using the droop method. Nominal output voltage is achieved at 50% load and output voltage drops at a rate of 48mv per amp for 12V output, 192mV per amp for 24V output, and 800mV per amp for 50V output. Startup of parallel power supplies is not internally synchronized. If more than 250W combined power is needed, start-up synchronization must be provided by using a common PS_ON signal. To account for ±10% full load current sharing accuracy and the reduction in full load output voltage due to droop, available output power must be derated by 15% when units are operated in parallel. Current sharing can be achieved with or without remote sense connected to the common load. If ORing protection is desired, please contact Murata sales for external ORing FET board or external ORing FET reference circuit design.</p> <p>Aux (V3) output can be tied together for redundancy but total combined output power must not exceed 10W, external ORing devices must be used.</p> <p>Fan (V2) can be tied together for redundancy but total combined output power must not exceed 12W, external ORing diodes can be used.</p>
MVAC250-24AFD	
MVAC250-48AFD	

EMISSIONS AND IMMUNITY

Characteristic	Standard	Compliance
Input Current Harmonics	IEC/EN 61000-3-2	Class A
Voltage Fluctuation and Flicker	IEC/EN 61000-3-3	Complies
Conducted Emissions	EN 55022	Class B
	FCC Part 15	Class B
ESD Immunity	IEC/EN 61000-4-2	Level 4, Criterion 2
Radiated Field Immunity	IEC/EN 61000-4-3	Level 3, Criterion A
Electrical Fast Transient Immunity	IEC/EN 61000-4-4	Level 4, Criterion A
Surge Immunity	IEC/EN 61000-4-5	Level 3, Criterion A
Radiated Field Conducted Immunity	IEC/EN 61000-4-6	Level 3, 10V/m, Criterion A
Magnetic Field Immunity	IEC/EN 61000-4-8	Level 3, Criterion A
Voltage dips, interruptions	IEC/EN 61000-4-11	Level 3, Criterion B

EMI CONSIDERATIONS

For optimum EMI performance, the power supply should be mounted to a metal plate grounded to all 4 mounting holes of the power supply. To comply with safety standards, this plate must be properly grounded to protective earth (see mechanical dimension notes). Pre-compliance testing has shown the stand-alone power supply to comply with EN55022 class A radiated emissions. Radiated emission results vary with system enclosure and cable routing paths.

STATUS AND CONTROL SIGNALS – MVAC250-xxAFD ONLY

Parameter	Conditions
PS_ON	This signal must be sinked low (>2mA) to +5V_AUX_RTN to turn on the main and Fan (V2) output. The +5V_AUX output is on when AC is applied.
PWR_OK	Open collector logic goes high 50-200 msec after main output is in regulation; it goes low at least 6 msec before loss of regulation. Internal 10K pull up to +5V_AUX is provided.

PERFORMANCE DATA

MVAC250-12F Efficiency

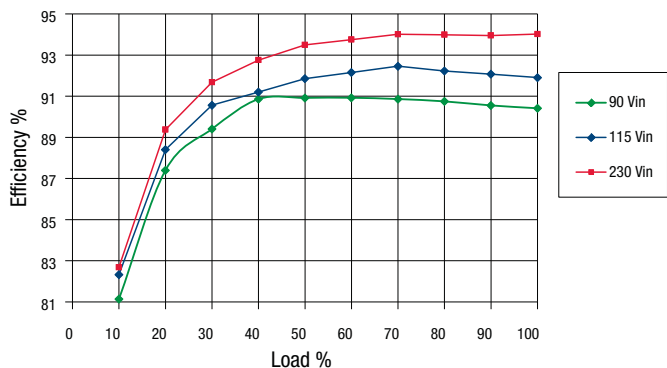

MVAC250-24F Efficiency

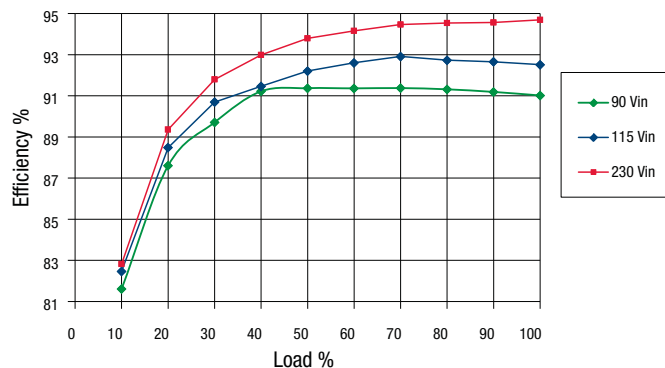

MVAC250-48F Efficiency

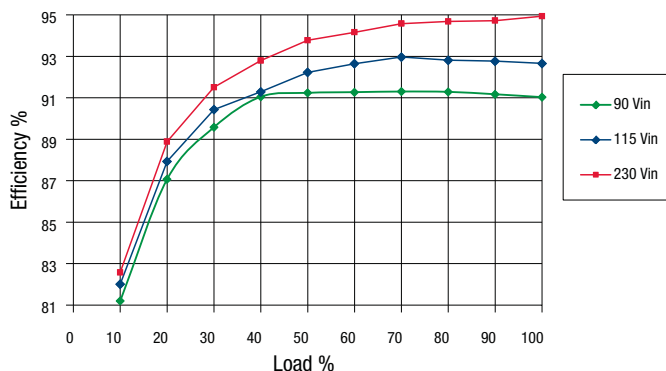

THERMAL CONSIDERATIONS

System thermal management is critical to the performance and reliability of the MVAC series power supplies. Performance derating curves are provided which can be used as a guideline for what can be achieved in a system configuration with controlled airflow at various input voltage conditions.

The air flow curves are generated using an AMCA 210-99 and ASHRAE 51-1999 compliant wind tunnel with heated inlet air and a controlled CFM providing a duct test section having a calculated average LFM. A correlation between the test setup and the actual system environment is paramount to understanding what can be achieved in an actual system. In a power supply of this density, cooling air moving both through the unit as well as around the unit strongly influences local temperatures. The wind tunnel test setup was constructed to produce a flow with a slight back pressure to induce both flow conditions by providing a small gap between the power supply and duct walls of 0.5" (13mm). The optimal and characterized airflow direction is from the input connector to the output connector (see diagram below). The P-Q flow curve for this test setup is also shown below.

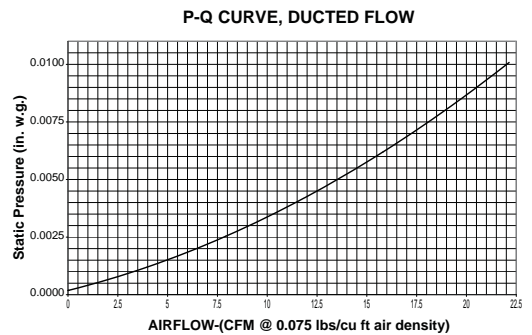
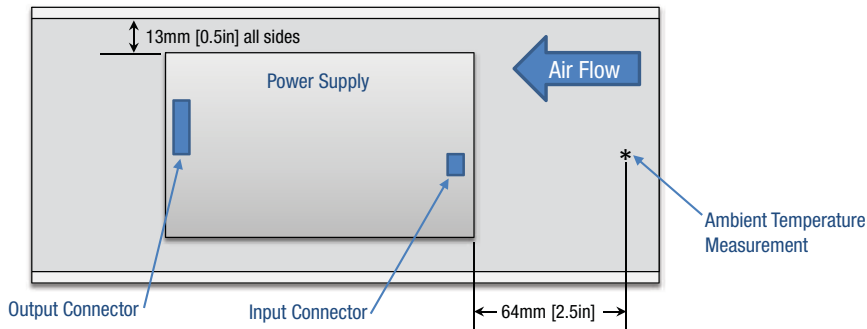

The natural convection data is obtained from a horizontally mounted power supply with un-obstructed flow at room temperature. At elevated temperature the power supply data is taken while it is surrounded by a large vented enclosure to minimize forced cross flows inherent in the elevated temperature test system.

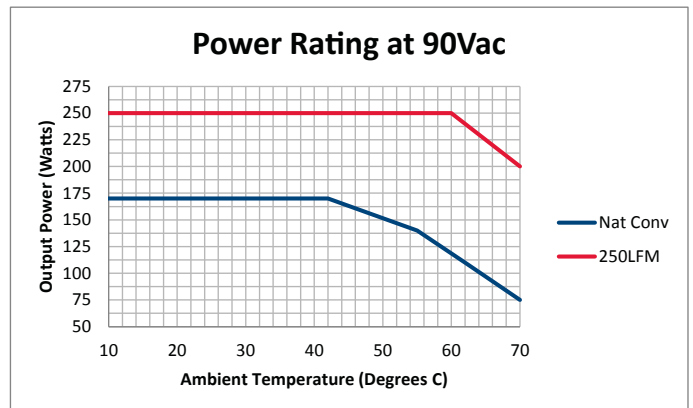
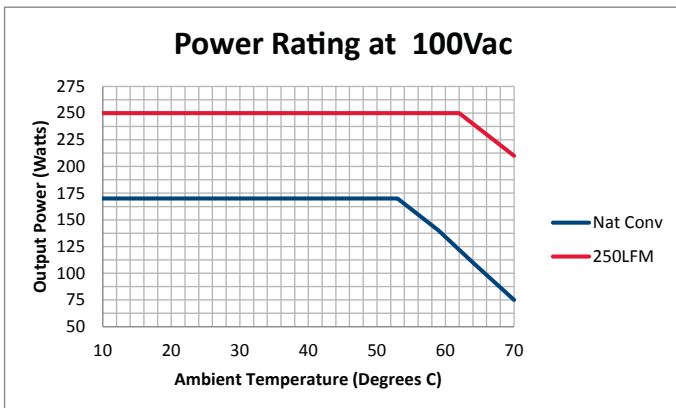
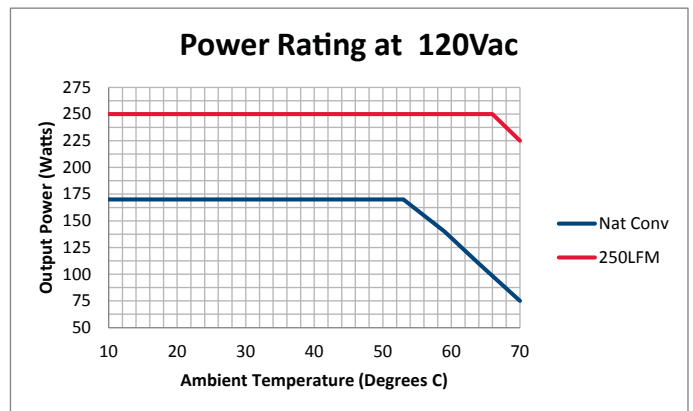
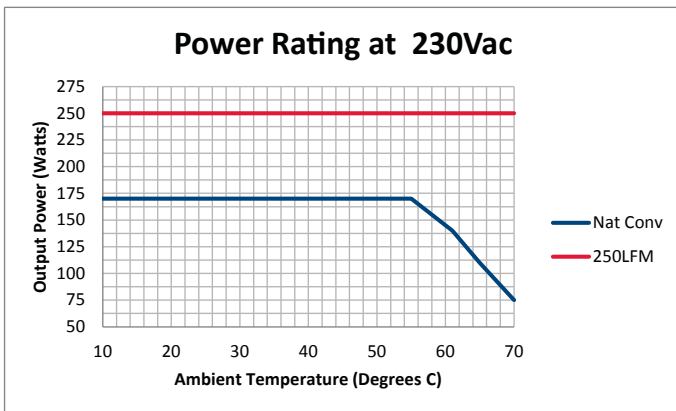

INRUSH CURRENT



Time: 100 mSec/Div, Ch1: 500 V/Div, Ch4: 20 A/Div, Vin: 264 VAC, Ipk = 15.1 A
AC applied at peak of sine wave

WIRING DIAGRAM FOR OUTPUT

Dotted lines show optional remote sense connections.
Optional remote sense lines can be attached to a load that is a distance away from the power supply to improve regulation at the load.

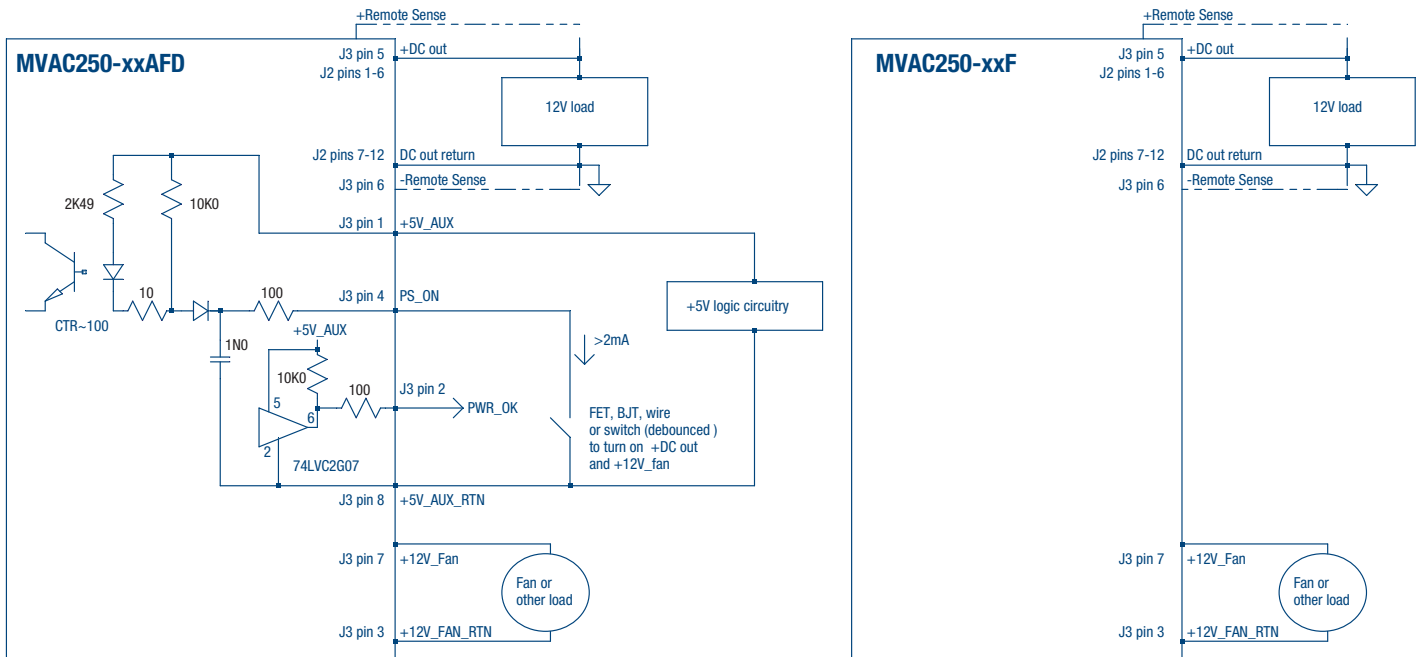

APPLICATION NOTE

Document Number	Description	Link
ACAN-42 MVAC Series	External ORing FET Reference Circuit	www.murata-ps.com/data/apnotes/acan-42.pdf

MECHANICAL DIMENSIONS – MVAC250-xxF ONLY

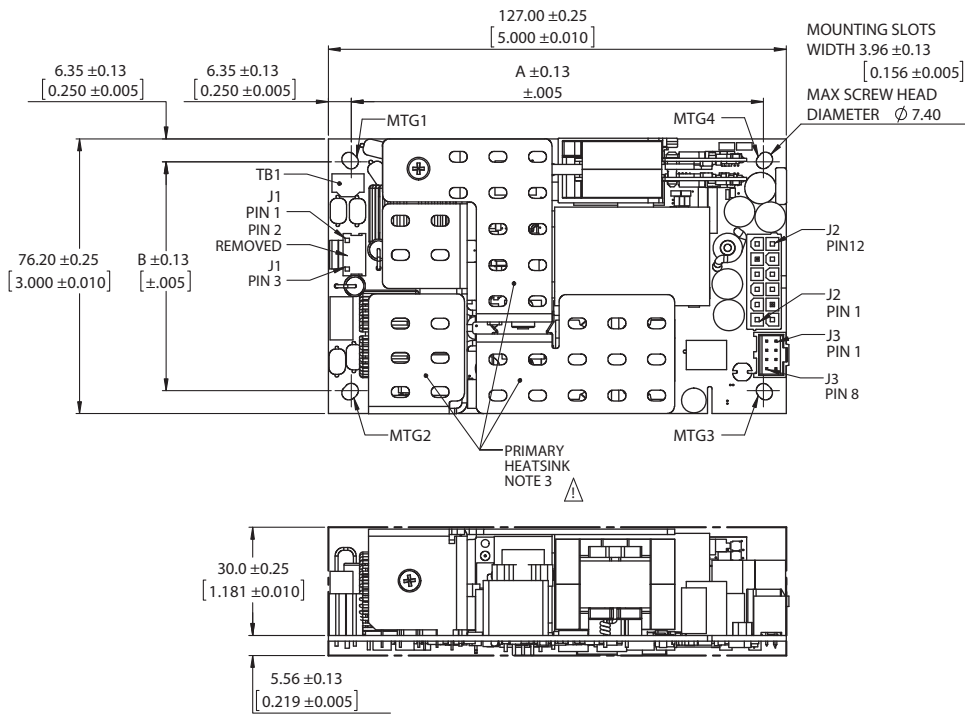

MTG1-4

MOUNTING GRIDS	A	B
4.50 x 2.50	114.30 [4.500]	63.50 [2.500]
4.55 x 2.55	115.57 [4.550]	64.77 [2.550]

J2			
6	12	1-6	+DC_OUT
5	11	7-12	+DC_OUT_RTN
4	10		
3	9		
2	8		
1	7		

J3			
2	1	1	DO NOT USE
4	3	2	DO NOT USE
6	5	3	+12V_FAN_RTN
8	7	4	DO NOT USE
		5	+REMOTE_SENSE
		6	-REMOTE_SENSE
		7	+12V_FAN
		8	DO NOT USE

ALL DIMENSIONS ARE IN MM [IN].

NOTES:



- Protective bonding conductor from the end product protective earthing terminal must be tied to TB1. For optimum EMI performance, 4 mounting holes must be tied to the end product protective earthing terminal.
- This power supply requires mounting on standoffs minimum 6mm in height. If there is risk of chassis deformation or shorter standoff height is required, an appropriate insulator must be used under the power supply with adequate extension beyond the outline of the power supply. In all cases, the applicable safety standards must be applied to ensure proper creepage and clearance requirements are met.
- The primary heatsink is considered a live primary circuit, and should not be touched. Also, the primary and secondary heatsinks must be separated with reinforced insulation. It is recommended that the primary heatsink be kept at least 3.5mm from chassis and 7mm from secondary circuits. In all cases, the applicable safety standards must be applied to ensure proper creepage and clearance requirements are met.
- This product is subject to the following [operating requirements](http://www.murata-ps.com/requirements/) and the [Life and Safety Critical Application Sales Policy](#): Refer to: <http://www.murata-ps.com/requirements/>

Dimensions: 3.0" x 5.0" x 1.4" (76.2mm x 127mm x 35.6mm)

INPUT/OUTPUT CONNECTOR AND SIGNAL SPECIFICATION AND MATING CONNECTORS – MVAC250-xxF ONLY

Connector	PIN	Description	Mating Housing	Crimp terminal/pins
Input Connector J1 : Molex 26-62-4030	1	AC Neutral	Molex 0009930300	Molex 0008500105 (18-24 AWG) Molex 0008500107 (22-26 AWG)
	3	AC Line		
Output Connector J2 : Molex 39-28-1123	1,2,3,4,5,6	+DC_OUT	Molex 0039012125	Molex 0039000038
	7,8,9,10,11,12	+DC_OUT_RTN		
Output Connector J3: Molex 90130-1108	1	DO NOT USE	Molex 0901420008	Molex 0901190109
	2	DO NOT USE		
	3	+12V_FAN_RTN		
	4	DO NOT USE		
	5	+ Remote Sense		
	6	- Remote Sense		
	7	+12V_FAN		
	8	DO NOT USE		

MECHANICAL DIMENSIONS – MVAC250-xxAFD ONLY

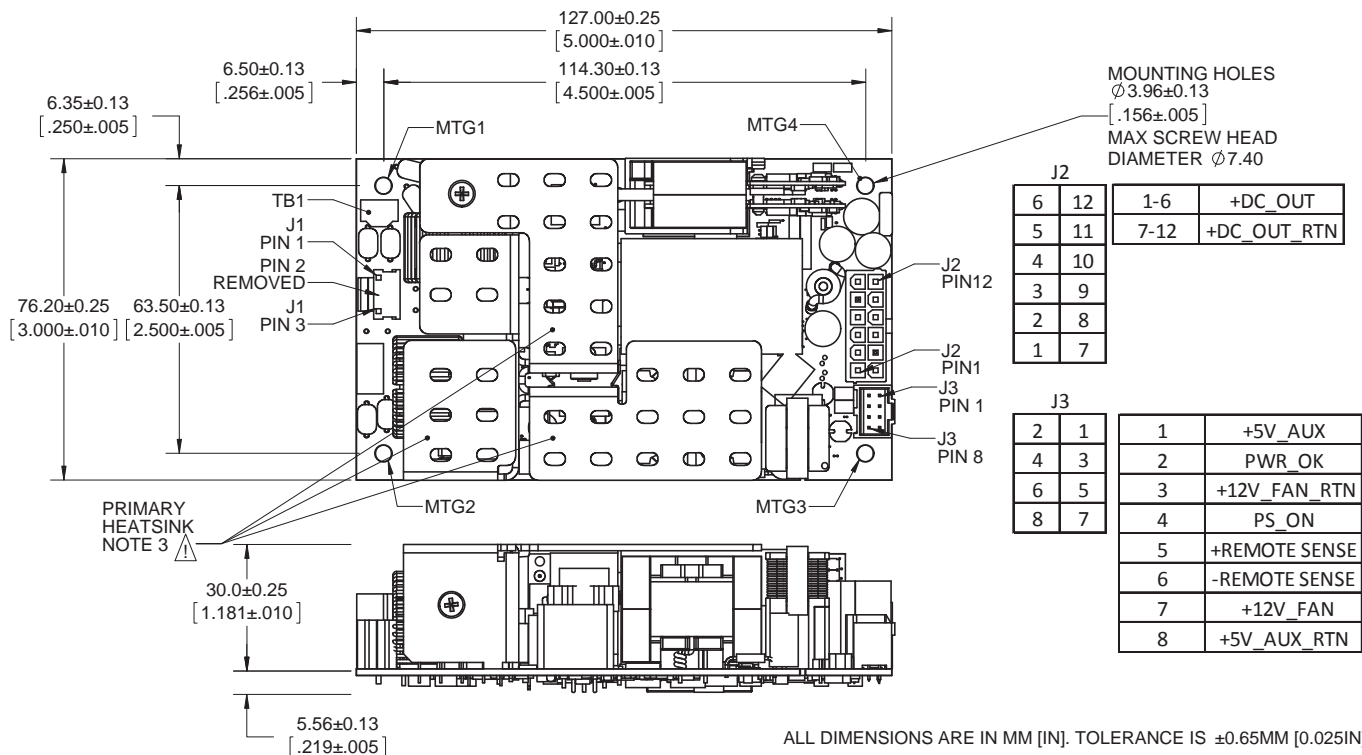

NOTES:



- Protective bonding conductor from the end product protective earthing terminal must be tied to TB1. For optimum EMI performance, 4 mounting holes must be tied to the end product protective earthing terminal.
- This power supply requires mounting on standoffs minimum 6mm in height. If there is risk of chassis deformation or shorter standoff height is required, an appropriate insulator must be used under the power supply with adequate extension beyond the outline of the power supply. In all cases, the applicable safety standards must be applied to ensure proper creepage and clearance requirements are met.
- The primary heatsink is considered a live primary circuit, and should not be touched. Also, the primary and secondary heatsinks must be separated with reinforced insulation. It is recommended that the primary heatsink be kept at least 3.5mm from chassis and 7mm from secondary circuits. In all cases, the applicable safety standards must be applied to ensure proper creepage and clearance requirements are met.
- This product is subject to the following [operating requirements](http://www.murata-ps.com/requirements/) and the [Life and Safety Critical Application Sales Policy](#): Refer to: <http://www.murata-ps.com/requirements/>

Dimensions: 3.0" x 5.0" x 1.4" (76.2mm x 127mm x 35.6mm)

INPUT/OUTPUT CONNECTOR AND SIGNAL SPECIFICATION AND MATING CONNECTORS – MVAC250-xxAFD ONLY

Connector	PIN	Description	Mating Housing	Crimp terminal/pins
Input Connector J1 : Molex 26-62-4030	1	AC Neutral	Molex 0009930300	Molex 0008500105 (18-24 AWG) Molex 0008500107 (22-26 AWG)
	3	AC Line		
Output Connector J2 : Molex 39-28-1123	1,2,3,4,5,6	+DC_OUT	Molex 0039012125	Molex 0039000038
	7,8,9,10,11,12	+DC_OUT_RTN		
Output Connector J3: Molex 90130-1108	1	+5V_AUX	Molex 0901420008	Molex 0901190109
	2	PWR_OK		
	3	+12V_FAN_RTN		
	4	PS_ON		
	5	+ Remote Sense		
	6	- Remote Sense		
	7	+12V_FAN		
	8	+5V_AUX_RTN		

Murata Power Solutions, Inc.
 11 Cabot Boulevard, Mansfield, MA 02048-1151 U.S.A.
 ISO 9001 and 14001 REGISTERED



This product is subject to the following [operating requirements](#) and the [Life and Safety Critical Application Sales Policy](#): Refer to: <http://www.murata-ps.com/requirements/>

Murata Power Solutions, Inc. makes no representation that the use of its products in the circuits described herein, or the use of other technical information contained herein, will not infringe upon existing or future patent rights. The descriptions contained herein do not imply the granting of licenses to make, use, or sell equipment constructed in accordance therewith. Specifications are subject to change without notice. © 2013 Murata Power Solutions, Inc.

Данный компонент на территории Российской Федерации

Вы можете приобрести в компании MosChip.

Для оперативного оформления запроса Вам необходимо перейти по данной ссылке:

<http://moschip.ru/get-element>

Вы можете разместить у нас заказ для любого Вашего проекта, будь то серийное производство или разработка единичного прибора.

В нашем ассортименте представлены ведущие мировые производители активных и пассивных электронных компонентов.

Нашей специализацией является поставка электронной компонентной базы двойного назначения, продукции таких производителей как XILINX, Intel (ex.ALTERA), Vicor, Microchip, Texas Instruments, Analog Devices, Mini-Circuits, Amphenol, Glenair.

Сотрудничество с глобальными дистрибьюторами электронных компонентов, предоставляет возможность заказывать и получать с международных складов практически любой перечень компонентов в оптимальные для Вас сроки.

На всех этапах разработки и производства наши партнеры могут получить квалифицированную поддержку опытных инженеров.

Система менеджмента качества компании отвечает требованиям в соответствии с ГОСТ Р ИСО 9001, ГОСТ РВ 0015-002 и ЭС РД 009

Офис по работе с юридическими лицами:

105318, г.Москва, ул.Щербаковская д.3, офис 1107, 1118, ДЦ «Щербаковский»

Телефон: +7 495 668-12-70 (многоканальный)

Факс: +7 495 668-12-70 (доб.304)

E-mail: info@moschip.ru

Skype отдела продаж:

moschip.ru

moschip.ru_4

moschip.ru_6

moschip.ru_9