



FEATURES

- 3rd ed. medical and ITE safety approved
- 250W compact high density
- 3" x 5" standard footprint
- High efficiency up to 94%
- Remote sense
- Remote On/Off, Power OK (MVAC250-xxAFD)
- Universal AC input with active PFC
- Less than 1U high – 1.4"
- Convection cooled operation up to 170W
- Isolated 12V@1A fan output
- Isolated 5V@2A standby output with current share model MVAC250-xxAFD
- RoHS compliant
- Active inrush protection
- Current sharing option

DESCRIPTION

The MVAC250 series switching power supplies utilize advanced component and circuit technologies to deliver high efficiency. Designed for medical, computing, communications, telecom and other OEM applications to satisfy 1U height design considerations, the MVAC250 Series measures only 3.0" x 5.0" x 1.40". All models offer universal AC input with active power factor correction (PFC) and compliance to worldwide safety and EMC standards.



Available now at
www.murata-ps.com/en/3d/acdc.html



ORDERING GUIDE

| Model Number* | Natural Convection Cooling | Forced Air Cooling | Main Output (V1) | Fan Output (V2) | Aux Output (V3) |
|---------------|---|--------------------|------------------|-----------------|-----------------|
| | MVAC250-12F | 170W | 250W @ 250LFM | 12V | 12V |
| MVAC250-24F | 24V | | | 12V | |
| MVAC250-48F | 50V | | | 12V | |
| MVAC250-xxAFD | These models also include aux output (V3) | | | | 5V |

* Refer to page 2 for current sharing model numbers MVAC250-xxAFD

INPUT CHARACTERISTICS

| Parameter | Conditions | Min. | Typ. | Max. | Units |
|--------------------------------------|------------------------------------|------|---------|------|-------|
| Input Voltage Operating Range* | Single phase | 90 | 115/230 | 264 | Vac |
| Input Frequency | | 47 | 50/60 | 63 | Hz |
| Turn-on Input Voltage | Input rising | 80 | | 90 | Vac |
| Turn-off Input Voltage | Input falling | 70 | | 80 | |
| Input Current | 90Vac input, full load all outputs | | | 3.4 | A |
| No Load Input Power (MVAC250-xxAFD)* | (PS_ON = OFF, 5V_Aux = 0A) | 1.5 | | 2.0 | W |
| Inrush Current | At 264Vac, at 25°C cold start | | 15 | | Apk |
| Power Factor | At 230Vac, full load | | 0.96 | | |

*DC Input 127-300Vdc optionally available; contact your Murata salesperson.

OUTPUT CHARACTERISTICS

| Model Number | Main Output Voltage (V1) | Load Current | Maximum Load Capacitance | Line, Load, Cross Regulation | Typical Efficiency @230Vac |
|---------------|--------------------------|--------------|--------------------------|------------------------------|----------------------------|
| MVAC250-12F | 12V | 0.4 to 20.8A | 0 to 1500µF | ± 1% | 93% |
| MVAC250-24F | 24V | 0.2 to 10.4A | 0 to 300µF | ± 1% | 93% |
| MVAC250-48F | 50V | 0.1 to 5.0A | 0 to 82µF | ± 1% | 94% |
| MVAC250-12AFD | 12V @ 10.4A ⁶ | 0 to 20.8A | 0 to 1500µF | ± 1.5% ⁶ | 93% |
| MVAC250-24AFD | 24V @ 5.2A ⁶ | 0 to 10.4A | 0 to 300µF | ± 1.5% ⁶ | 93% |
| MVAC250-48AFD | 50V @ 2.5A ⁶ | 0 to 5.0A | 0 to 82µF | ± 1.5% ⁶ | 94% |

Main Output Characteristics (all models)

| Parameter | Conditions | Typ. | Max. | Units |
|-------------------------------------|--|------|------|-------|
| Transient Response | 50% load step, 1A/µsec slew rate | | ± 5 | % |
| Settling Time to 1% of Nominal | | | 500 | µsec |
| Turn On Delay | After application of input power | | 3 | sec |
| Output Voltage Rise | Monotonic ⁵ | | 50 | msec |
| Output Holdup | 120Vac/60Hz, full load | 20 | | |
| Temperature Coefficient | | | 0.02 | %/°C |
| Ripple Voltage & Noise ¹ | | | 1 | % |
| Remote Sense | Compensates for up to 0.5V of lead drop with remote sense connected. Protected against short circuit and reverse connection. | | 500 | mV |

Auxiliary Output Characteristics (varies by model)

| Auxiliary Output | Aux Output Voltage ⁸ | Load Current | Load Capacitance | Line, Load, Cross Regulation ³ | Ripple Voltage & Noise ¹ |
|--------------------------|---------------------------------|--------------|------------------|---|-------------------------------------|
| Fan (V2) all models | 12V | 0 to 1A | 0 to 220µF | ± 10% | 2% |
| Aux (V3) – MVAC250-xxAFD | 5V | 0 to 2A | 0 to 220µF | ± 5% | 1% |

1. Noise and ripple is measured at an oscilloscope jack on the output, 20MHz bandwidth, and with 0.1µF ceramic and 10µF aluminum electrolytic capacitors across the output pins.
2. Unless otherwise specified all measurements are taken at 120Vac input and 25°C ambient temperature.
3. Fan (V2) regulation band applies from 0.1A to 1A load with a minimum of 10W load on the main (V1) output.
4. Fan (V2) has overvoltage protection (tracking V1) and short circuit protection. Overloading the Fan (V2) output can result in permanent damage to the unit.
5. 24V and 50V models may exhibit up to 5% turn on overshoot for loads less than 4% of full load.
6. See current sharing option section for droop characteristics.
7. No load Input power varies by model and by input line. Measurement is difficult to make due to burst mode operation. Please contact Murata sales if additional information is required.
8. All three output returns are isolated from each other (see isolation characteristics section); the returns may be tied together externally.

| ENVIRONMENTAL CHARACTERISTICS | | | | | |
|-------------------------------|--|----------------------------------|------|------|-------|
| Parameter | Conditions | Min. | Typ. | Max. | Units |
| Storage Temperature Range | | -40 | | 85 | °C |
| Operating Temperature Range | See power rating curves | -10 | | 70 | |
| | Start up | -20 | | | |
| Operating Humidity | Non-condensing | 10 | | 95 | % |
| Operating Altitude | | -200 | | 3000 | m |
| MTBF | Telcordia SR-332 M1C3 @25°C | 474K | | | Hours |
| Shock | Operating, MIL-HBK-810E | Complies | | | |
| | Non-operating, MIL-HBK-810E | Complies | | | |
| Operational Vibration | IEC-68-2-27 standard | Complies to levels of IEC721-3-2 | | | |
| Safety | IEC60950-1:2006/A11:2009 UL60950-1 2nd Ed. 2007-03-27, CSA22.2 No.60950-1 2nd Ed. 2007.03, EN60690-1:2006+A11:2009 (Pending) IEC60601-1 Ed. 3 MOOP ANSI/AAMI ES60601-1 (2005+C1:09+A2:10), CSA 22.2 No. 60601-1 (2008) 3rd Edition MOOP EN60601-1:2006 3rd ed. MOOP (Pending) CE Marking per LVD | | | | |
| Warranty | 2 years | | | | |
| Outside Dimensions | 3.0" x 5.0" x 1.4" (76.2mm x 127mm x 35.6mm) | | | | |
| Weight | MVAC250-xxF: 0.73 lbs (332.9g); MVAC250-xxAFD: 0.76 lbs (344.7g) | | | | |

| RESIDUAL RISK (PER ISO 14971 & IEC60601-1) FOR USER CONSIDERATION | |
|---|---|
| Fault Condition | Residual Risk |
| Complies | Contact your Murata salesperson for details |

| PROTECTION CHARACTERISTICS | | | | | |
|--|---|------|----------|------|-------|
| Parameter | Conditions | Min. | Typ. | Max. | Units |
| Over Voltage Protection ⁴ | V1 (main output) latching | 110 | | 125 | % |
| | V3 (aux output: MVAC250-xxAFD) latching | 5.5 | | 7.5 | V |
| Over Current Protection ⁴ | V1, hiccup mode | 110 | | 130 | %Amax |
| Over Temperature Protection | Auto-recovery | | Complies | | |
| Remote Sense Short Circuit Protection | | | Complies | | |
| Remote Sense Reverse Connection Protection | | | Complies | | |

| ISOLATION CHARACTERISTICS | | | | | |
|--|-----------------------------------|------|------|------|-------|
| Parameter | Conditions | Min. | Typ. | Max. | Units |
| Isolation | Primary to Chassis | 1500 | | | Vac |
| | Primary to Secondary | 3000 | | | |
| | Secondary to Chassis | 500 | | | |
| | Output to Output | 500 | | | |
| Earth Leakage Current (under single fault condition) | MVAC250-xxAFD: 264Vac, 60Hz, 25°C | | 300 | | µA |
| | MVAC250-xxF: 264Vac, 60Hz, 25°C | | 350 | | |
| Earth Leakage Current (under normal conditions) | MVAC250-xxAFD: 264Vac, 60Hz, 25°C | | 150 | | |
| | MVAC250-xxF: 264Vac, 60Hz, 25°C | | 250 | | |

| CURRENT SHARING OPTION – MVAC250-xxAFD ONLY | |
|---|---|
| Model Number | Description |
| MVAC250-12AFD | <p>Current Sharing Notes:</p> <p>Main Output: Current share is achieved using the droop method. Nominal output voltage is achieved at 50% load and output voltage drops at a rate of 48mv per amp for 12V output, 192mV per amp for 24V output, and 800mV per amp for 50V output. Startup of parallel power supplies is not internally synchronized. If more than 250W combined power is needed, start-up synchronization must be provided by using a common PS_ON signal. To account for ±10% full load current sharing accuracy and the reduction in full load output voltage due to droop, available output power must be derated by 15% when units are operated in parallel. Current sharing can be achieved with or without remote sense connected to the common load. If ORing protection is desired, please contact Murata sales for external ORing FET board or external ORing FET reference circuit design.</p> <p>Aux (V3) output can be tied together for redundancy but total combined output power must not exceed 10W, external ORing devices must be used.</p> <p>Fan (V2) can be tied together for redundancy but total combined output power must not exceed 12W, external ORing diodes can be used.</p> |
| MVAC250-24AFD | |
| MVAC250-48AFD | |

EMISSIONS AND IMMUNITY

| Characteristic | Standard | Compliance |
|------------------------------------|-------------------|-----------------------------|
| Input Current Harmonics | IEC/EN 61000-3-2 | Class A |
| Voltage Fluctuation and Flicker | IEC/EN 61000-3-3 | Complies |
| Conducted Emissions | EN 55022 | Class B |
| | FCC Part 15 | Class B |
| ESD Immunity | IEC/EN 61000-4-2 | Level 4, Criterion 2 |
| Radiated Field Immunity | IEC/EN 61000-4-3 | Level 3, Criterion A |
| Electrical Fast Transient Immunity | IEC/EN 61000-4-4 | Level 4, Criterion A |
| Surge Immunity | IEC/EN 61000-4-5 | Level 3, Criterion A |
| Radiated Field Conducted Immunity | IEC/EN 61000-4-6 | Level 3, 10V/m, Criterion A |
| Magnetic Field Immunity | IEC/EN 61000-4-8 | Level 3, Criterion A |
| Voltage dips, interruptions | IEC/EN 61000-4-11 | Level 3, Criterion B |

EMI CONSIDERATIONS

For optimum EMI performance, the power supply should be mounted to a metal plate grounded to all 4 mounting holes of the power supply. To comply with safety standards, this plate must be properly grounded to protective earth (see mechanical dimension notes). Pre-compliance testing has shown the stand-alone power supply to comply with EN55022 class A radiated emissions. Radiated emission results vary with system enclosure and cable routing paths.

STATUS AND CONTROL SIGNALS – MVAC250-xxAFD ONLY

| Parameter | Conditions |
|-----------|--|
| PS_ON | This signal must be sinked low (>2mA) to +5V_AUX_RTN to turn on the main and Fan (V2) output. The +5V_AUX output is on when AC is applied. |
| PWR_OK | Open collector logic goes high 50-200 msec after main output is in regulation; it goes low at least 6 msec before loss of regulation. Internal 10K pull up to +5V_AUX is provided. |

PERFORMANCE DATA

MVAC250-12F Efficiency

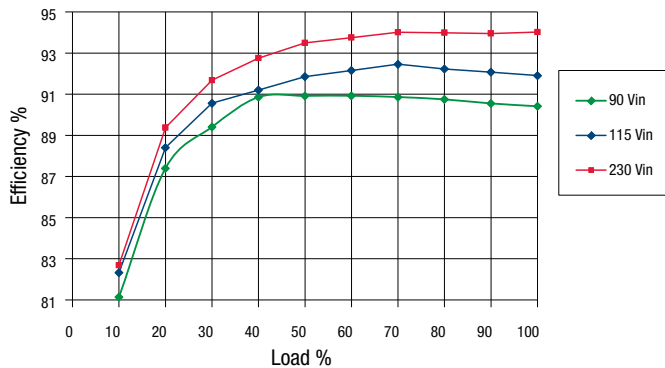

MVAC250-24F Efficiency

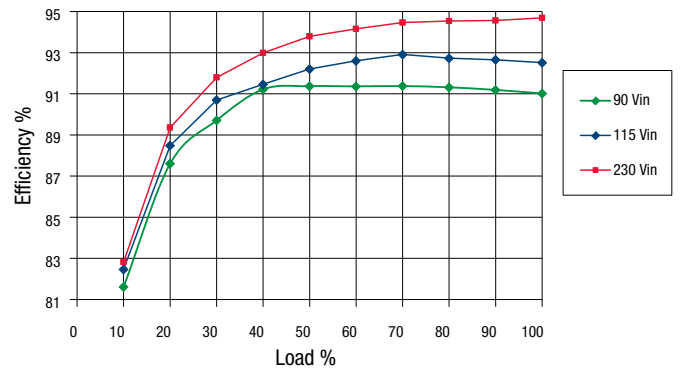

MVAC250-48F Efficiency

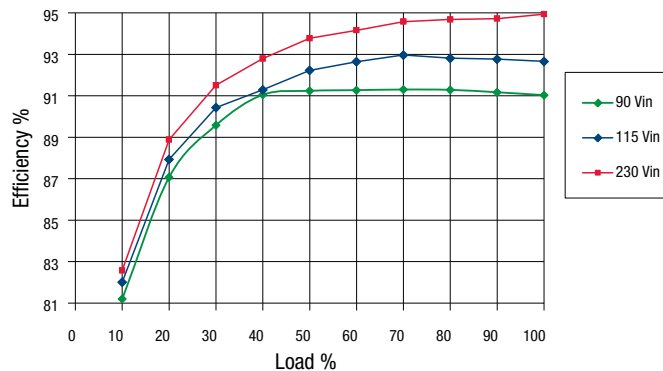

THERMAL CONSIDERATIONS

System thermal management is critical to the performance and reliability of the MVAC series power supplies. Performance derating curves are provided which can be used as a guideline for what can be achieved in a system configuration with controlled airflow at various input voltage conditions.

The air flow curves are generated using an AMCA 210-99 and ASHRAE 51-1999 compliant wind tunnel with heated inlet air and a controlled CFM providing a duct test section having a calculated average LFM. A correlation between the test setup and the actual system environment is paramount to understanding what can be achieved in an actual system. In a power supply of this density, cooling air moving both through the unit as well as around the unit strongly influences local temperatures. The wind tunnel test setup was constructed to produce a flow with a slight back pressure to induce both flow conditions by providing a small gap between the power supply and duct walls of 0.5" (13mm). The optimal and characterized airflow direction is from the input connector to the output connector (see diagram below). The P-Q flow curve for this test setup is also shown below.

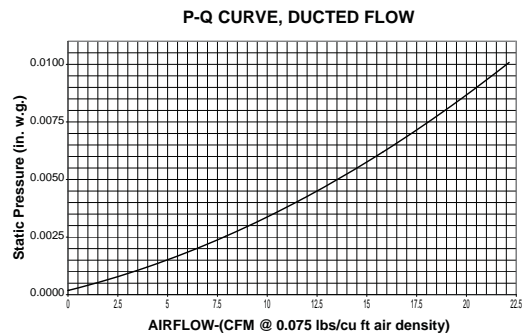
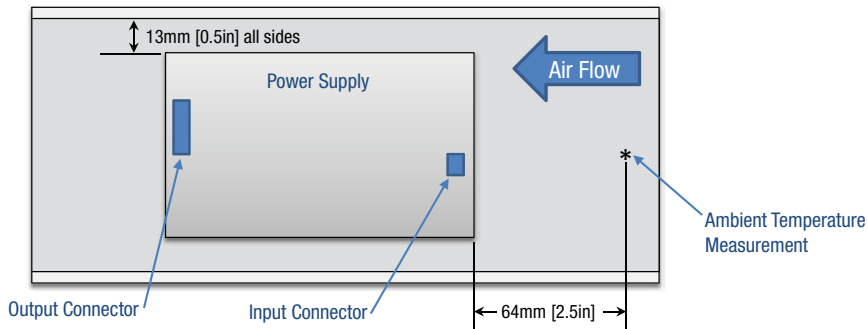

The natural convection data is obtained from a horizontally mounted power supply with un-obstructed flow at room temperature. At elevated temperature the power supply data is taken while it is surrounded by a large vented enclosure to minimize forced cross flows inherent in the elevated temperature test system.

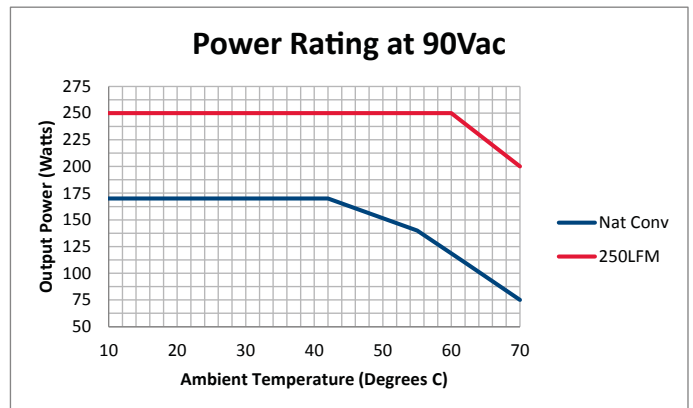
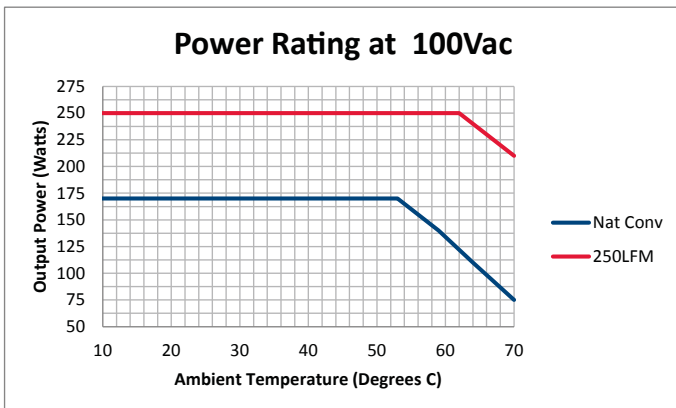
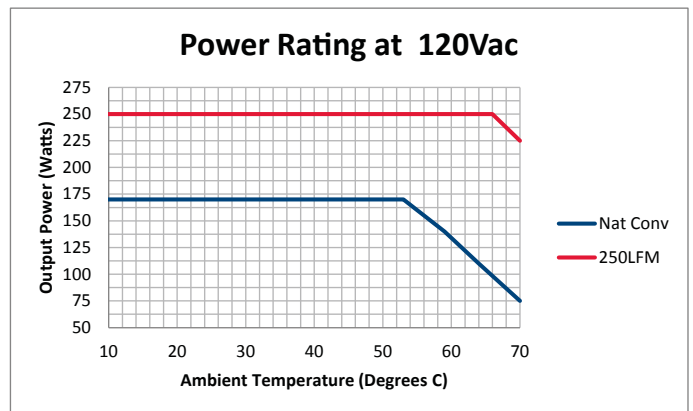
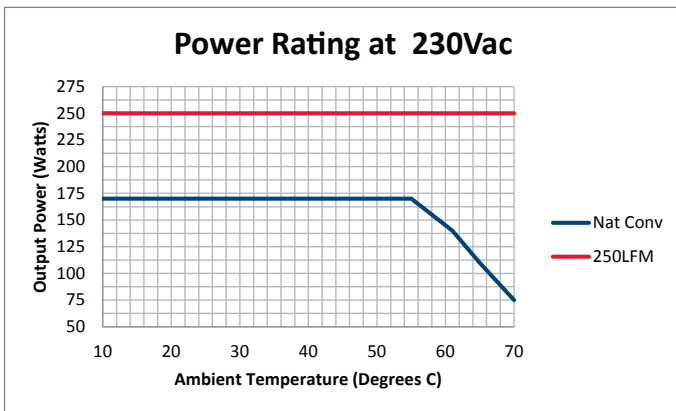

INRUSH CURRENT



Time: 100 mSec/Div, Ch1: 500 V/Div, Ch4: 20 A/Div, Vin: 264 VAC, Ipk = 15.1 A
AC applied at peak of sine wave

WIRING DIAGRAM FOR OUTPUT

Dotted lines show optional remote sense connections.
Optional remote sense lines can be attached to a load that is a distance away from the power supply to improve regulation at the load.

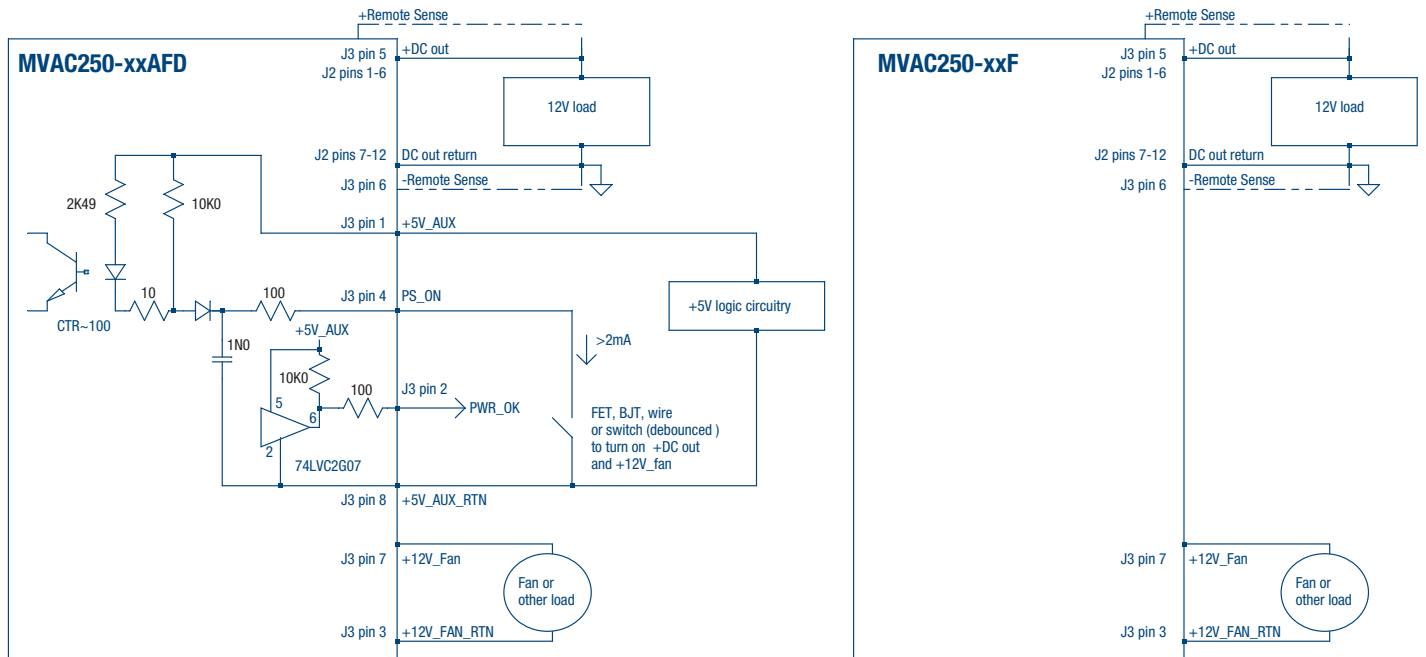

APPLICATION NOTE

| Document Number | Description | Link |
|---------------------|--------------------------------------|--|
| ACAN-42 MVAC Series | External ORing FET Reference Circuit | www.murata-ps.com/data/apnotes/acan-42.pdf |

MECHANICAL DIMENSIONS – MVAC250-xxF ONLY

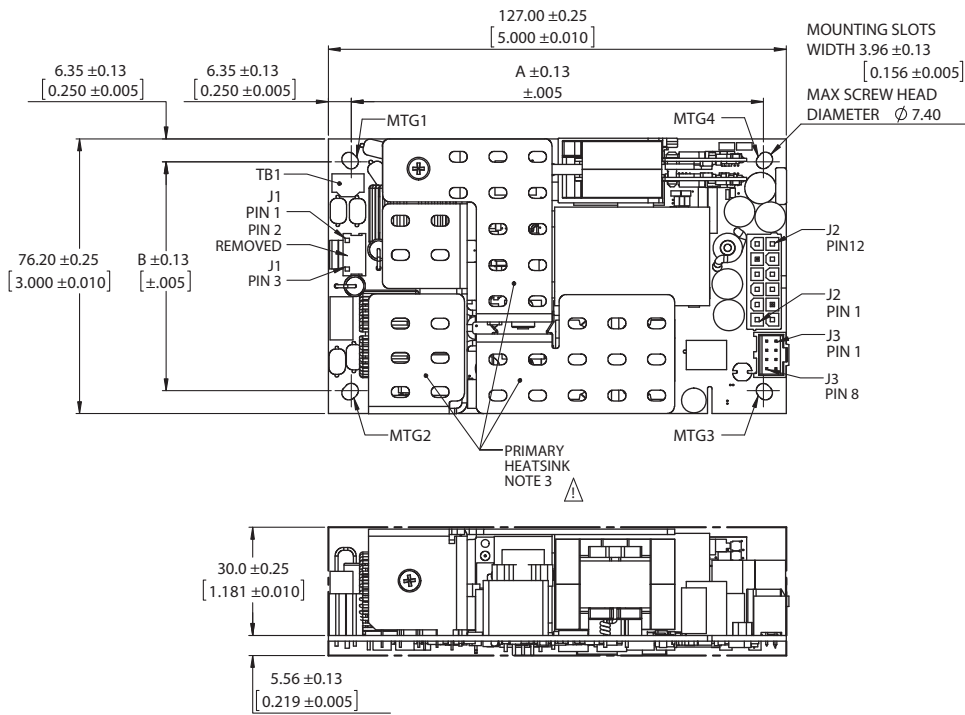

MTG1-4

| MOUNTING GRIDS | A | B |
|----------------|----------------|---------------|
| 4.50 x 2.50 | 114.30 [4.500] | 63.50 [2.500] |
| 4.55 x 2.55 | 115.57 [4.550] | 64.77 [2.550] |

| J2 | | |
|----|----|------------------|
| 6 | 12 | 1-6 +DC_OUT |
| 5 | 11 | 7-12 +DC_OUT_RTN |
| 4 | 10 | |
| 3 | 9 | |
| 2 | 8 | |
| 1 | 7 | |

| J3 | | |
|----|---|-----------------|
| 2 | 1 | 1 DO NOT USE |
| 4 | 3 | 2 DO NOT USE |
| 6 | 5 | 3 +12V_FAN_RTN |
| 4 | | 4 DO NOT USE |
| 5 | | 5 +REMOTE_SENSE |
| 6 | | 6 -REMOTE_SENSE |
| 7 | | 7 +12V_FAN |
| 8 | | 8 DO NOT USE |

ALL DIMENSIONS ARE IN MM [IN].

NOTES:



- Protective bonding conductor from the end product protective earthing terminal must be tied to TB1. For optimum EMI performance, 4 mounting holes must be tied to the end product protective earthing terminal.
- This power supply requires mounting on standoffs minimum 6mm in height. If there is risk of chassis deformation or shorter standoff height is required, an appropriate insulator must be used under the power supply with adequate extension beyond the outline of the power supply. In all cases, the applicable safety standards must be applied to ensure proper creepage and clearance requirements are met.
- The primary heatsink is considered a live primary circuit, and should not be touched. Also, the primary and secondary heatsinks must be separated with reinforced insulation. It is recommended that the primary heatsink be kept at least 3.5mm from chassis and 7mm from secondary circuits. In all cases, the applicable safety standards must be applied to ensure proper creepage and clearance requirements are met.
- This product is subject to the following [operating requirements](http://www.murata-ps.com/requirements/) and the [Life and Safety Critical Application Sales Policy](#): Refer to: <http://www.murata-ps.com/requirements/>

Dimensions: 3.0" x 5.0" x 1.4" (76.2mm x 127mm x 35.6mm)

INPUT/OUTPUT CONNECTOR AND SIGNAL SPECIFICATION AND MATING CONNECTORS – MVAC250-xxF ONLY

| Connector | PIN | Description | Mating Housing | Crimp terminal/pins |
|---|----------------|----------------|------------------|--|
| Input Connector J1 : Molex 26-62-4030 | 1 | AC Neutral | Molex 0009930300 | Molex 0008500105 (18-24 AWG) Molex 0008500107 (22-26 AWG) |
| | 3 | AC Line | | |
| Output Connector J2 : Molex 39-28-1123 | 1,2,3,4,5,6 | +DC_OUT | Molex 0039012125 | Molex 0039000038 |
| | 7,8,9,10,11,12 | +DC_OUT_RTN | | |
| Output Connector J3: Molex 90130-1108 | 1 | DO NOT USE | Molex 0901420008 | Molex 0901190109 |
| | 2 | DO NOT USE | | |
| | 3 | +12V_FAN_RTN | | |
| | 4 | DO NOT USE | | |
| | 5 | + Remote Sense | | |
| | 6 | - Remote Sense | | |
| | 7 | +12V_FAN | | |
| | 8 | DO NOT USE | | |

MECHANICAL DIMENSIONS – MVAC250-xxAFD ONLY

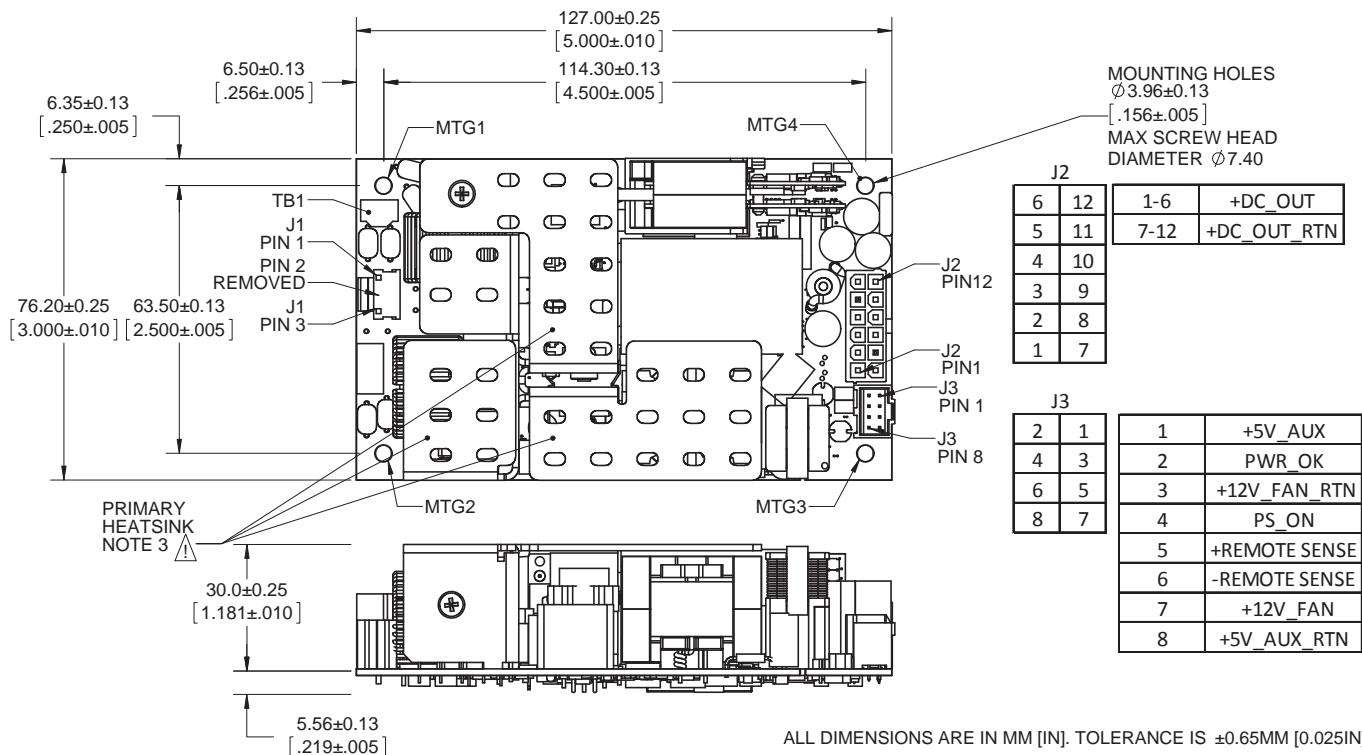

NOTES:



- Protective bonding conductor from the end product protective earthing terminal must be tied to TB1. For optimum EMI performance, 4 mounting holes must be tied to the end product protective earthing terminal.
- This power supply requires mounting on standoffs minimum 6mm in height. If there is risk of chassis deformation or shorter standoff height is required, an appropriate insulator must be used under the power supply with adequate extension beyond the outline of the power supply. In all cases, the applicable safety standards must be applied to ensure proper creepage and clearance requirements are met.
- The primary heatsink is considered a live primary circuit, and should not be touched. Also, the primary and secondary heatsinks must be separated with reinforced insulation. It is recommended that the primary heatsink be kept at least 3.5mm from chassis and 7mm from secondary circuits. In all cases, the applicable safety standards must be applied to ensure proper creepage and clearance requirements are met.
- This product is subject to the following [operating requirements](http://www.murata-ps.com/requirements/) and the [Life and Safety Critical Application Sales Policy](#): Refer to: <http://www.murata-ps.com/requirements/>

Dimensions: 3.0" x 5.0" x 1.4" (76.2mm x 127mm x 35.6mm)

INPUT/OUTPUT CONNECTOR AND SIGNAL SPECIFICATION AND MATING CONNECTORS – MVAC250-xxAFD ONLY

| Connector | PIN | Description | Mating Housing | Crimp terminal/pins |
|---|----------------|----------------|------------------|--|
| Input Connector J1 : Molex 26-62-4030 | 1 | AC Neutral | Molex 0009930300 | Molex 0008500105 (18-24 AWG) Molex 0008500107 (22-26 AWG) |
| | 3 | AC Line | | |
| Output Connector J2 : Molex 39-28-1123 | 1,2,3,4,5,6 | +DC_OUT | Molex 0039012125 | Molex 0039000038 |
| | 7,8,9,10,11,12 | +DC_OUT_RTN | | |
| Output Connector J3: Molex 90130-1108 | 1 | +5V_AUX | Molex 0901420008 | Molex 0901190109 |
| | 2 | PWR_OK | | |
| | 3 | +12V_FAN_RTN | | |
| | 4 | PS_ON | | |
| | 5 | + Remote Sense | | |
| | 6 | - Remote Sense | | |
| | 7 | +12V_FAN | | |
| | 8 | +5V_AUX_RTN | | |

Murata Power Solutions, Inc.
 11 Cabot Boulevard, Mansfield, MA 02048-1151 U.S.A.
 ISO 9001 and 14001 REGISTERED



This product is subject to the following [operating requirements](http://www.murata-ps.com/requirements/) and the [Life and Safety Critical Application Sales Policy](#): Refer to: <http://www.murata-ps.com/requirements/>

Murata Power Solutions, Inc. makes no representation that the use of its products in the circuits described herein, or the use of other technical information contained herein, will not infringe upon existing or future patent rights. The descriptions contained herein do not imply the granting of licenses to make, use, or sell equipment constructed in accordance therewith. Specifications are subject to change without notice. © 2013 Murata Power Solutions, Inc.

Данный компонент на территории Российской Федерации

Вы можете приобрести в компании MosChip.

Для оперативного оформления запроса Вам необходимо перейти по данной ссылке:

<http://moschip.ru/get-element>

Вы можете разместить у нас заказ для любого Вашего проекта, будь то серийное производство или разработка единичного прибора.

В нашем ассортименте представлены ведущие мировые производители активных и пассивных электронных компонентов.

Нашей специализацией является поставка электронной компонентной базы двойного назначения, продукции таких производителей как XILINX, Intel (ex.ALTERA), Vicor, Microchip, Texas Instruments, Analog Devices, Mini-Circuits, Amphenol, Glenair.

Сотрудничество с глобальными дистрибьюторами электронных компонентов, предоставляет возможность заказывать и получать с международных складов практически любой перечень компонентов в оптимальные для Вас сроки.

На всех этапах разработки и производства наши партнеры могут получить квалифицированную поддержку опытных инженеров.

Система менеджмента качества компании отвечает требованиям в соответствии с ГОСТ Р ИСО 9001, ГОСТ РВ 0015-002 и ЭС РД 009

Офис по работе с юридическими лицами:

105318, г.Москва, ул.Щербаковская д.3, офис 1107, 1118, ДЦ «Щербаковский»

Телефон: +7 495 668-12-70 (многоканальный)

Факс: +7 495 668-12-70 (доб.304)

E-mail: info@moschip.ru

Skype отдела продаж:

moschip.ru

moschip.ru_4

moschip.ru_6

moschip.ru_9