

FQA6N90C

900V N-Channel MOSFET

Features

- 6A, 900V, $R_{DS(on)} = 2.3\Omega @ V_{GS} = 10V$
- Low gate charge (typical 30 nC)
- Low C_{rss} (typical 11pF)
- Fast switching
- 100% avalanche tested
- Improved dv/dt capability

Description

These N-Channel enhancement mode power field effect transistors are produced using Fairchild's proprietary, planar stripe, DMOS technology.

This advanced technology has been especially tailored to minimize on-state resistance, provide superior switching performance, and withstand high energy pulse in the avalanche and commutation mode. These devices are well suited for high efficient switched mode power supplies, active power factor correction, electronic lamp ballast based on half bridge topology.

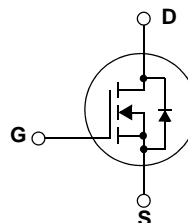
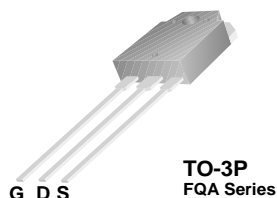

Absolute Maximum Ratings

Symbol	Parameter	FQA6N90C	Units
V_{DSS}	Drain-Source Voltage	900	V
I_D	Drain Current - Continuous ($T_C = 25^\circ\text{C}$)	6.0	A
	- Continuous ($T_C = 100^\circ\text{C}$)	3.87	A
I_{DM}	Drain Current - Pulsed (Note 1)	24.0	A
V_{GSS}	Gate-Source Voltage	± 30	V
E_{AS}	Single Pulsed Avalanche Energy (Note 2)	650	mJ
I_{AR}	Avalanche Current (Note 1)	6.4	A
E_{AR}	Repetitive Avalanche Energy (Note 1)	19.8	mJ
dv/dt	Peak Diode Recovery dv/dt (Note 3)	4.0	V/ns
P_D	Power Dissipation ($T_C = 25^\circ\text{C}$)	198	W
	- Derate above 25°C	1.59	W/ $^\circ\text{C}$
T_J, T_{STG}	Operating and Storage Temperature Range	-55 to +150	$^\circ\text{C}$
T_L	Maximum lead temperature for soldering purposes, 1/8" from case for 5 seconds	300	$^\circ\text{C}$

Thermal Characteristics

Symbol	Parameter	Typ	Max	Units
$R_{\theta JC}$	Thermal Resistance, Junction-to-Case	--	0.63	$^\circ\text{C}/\text{W}$
$R_{\theta CS}$	Thermal Resistance, Case-to-Sink	0.24	--	$^\circ\text{C}/\text{W}$
$R_{\theta JA}$	Thermal Resistance, Junction-to-Ambient	--	40	$^\circ\text{C}/\text{W}$

Package Marking and Ordering Information

Device Marking	Device	Package	Reel Size	Tape Width	Quantity
FQA6N90C	FQA6N90C	TO-3P	--	--	30
FQA6N90C	FQA6N90C_F109	TO-3PN	--	--	30

Electrical Characteristics T_C = 25°C unless otherwise noted

Symbol	Parameter	Test Conditions	Min	Typ	Max	Units
Off Characteristics						
BV _{DSS}	Drain-Source Breakdown Voltage	V _{GS} = 0 V, I _D = 250 μA	900	--	--	V
ΔBV _{DSS} /ΔT _J	Breakdown Voltage Temperature Coefficient	I _D = 250 μA, Referenced to 25°C	--	1.07	--	V/°C
I _{DSS}	Zero Gate Voltage Drain Current	V _{DS} = 900 V, V _{GS} = 0 V	--	--	10	μA
		V _{DS} = 720 V, T _C = 125°C	--	--	100	μA
I _{GSSF}	Gate-Body Leakage Current, Forward	V _{GS} = 30 V, V _{DS} = 0 V	--	--	100	nA
I _{GSSR}	Gate-Body Leakage Current, Reverse	V _{GS} = -30 V, V _{DS} = 0 V	--	--	-100	nA
On Characteristics						
V _{GS(th)}	Gate Threshold Voltage	V _{DS} = V _{GS} , I _D = 250 μA	3.0	--	5.0	V
R _{DS(on)}	Static Drain-Source On-Resistance	V _{GS} = 10 V, I _D = 3.0 A	--	1.93	2.3	Ω
g _{FS}	Forward Transconductance	V _{DS} = 50 V, I _D = 3.0 A (Note 4)	--	5.5	--	S
Dynamic Characteristics						
C _{iss}	Input Capacitance	V _{DS} = 25 V, V _{GS} = 0 V, f = 1.0 MHz	--	1360	1770	pF
C _{oss}	Output Capacitance		--	110	145	pF
C _{rss}	Reverse Transfer Capacitance		--	11	15	pF
Switching Characteristics						
t _{d(on)}	Turn-On Delay Time	V _{DD} = 450 V, I _D = 6.0A, R _G = 25 Ω (Note 4, 5)	--	35	80	ns
t _r	Turn-On Rise Time		--	90	190	ns
t _{d(off)}	Turn-Off Delay Time		--	55	120	ns
t _f	Turn-Off Fall Time		--	60	130	ns
Q _g	Total Gate Charge	V _{DS} = 720 V, I _D = 6.0A, V _{GS} = 10 V (Note 4, 5)	--	30	40	nC
Q _{gs}	Gate-Source Charge		--	9.0	--	nC
Q _{gd}	Gate-Drain Charge		--	12	--	nC
Drain-Source Diode Characteristics and Maximum Ratings						
I _S	Maximum Continuous Drain-Source Diode Forward Current		--	--	8.0	A
I _{SM}	Maximum Pulsed Drain-Source Diode Forward Current		--	--	32	A
V _{SD}	Drain-Source Diode Forward Voltage	V _{GS} = 0 V, I _S = 6.0 A	--	--	1.4	V
t _{rr}	Reverse Recovery Time	V _{GS} = 0 V, I _S = 6.0 A, dI _F / dt = 100 A/μs (Note 4)	--	630	--	ns
Q _{rr}	Reverse Recovery Charge		--	6.9	--	μC

NOTES:

1. Repetitive Rating : Pulse width limited by maximum junction temperature
2. L = 34mH, I_{AS} = 6.0A, V_{DD} = 50V, R_G = 25 Ω, Starting T_J = 25°C
3. I_{SD} ≤ 6.0A, di/dt ≤ 200A/μs, V_{DD} ≤ BV_{DSS}, Starting T_J = 25°C
4. Pulse Test : Pulse width ≤ 300μs, Duty cycle ≤ 2%
5. Essentially independent of operating temperature

Typical Performance Characteristics

Figure 1. On-Region Characteristics

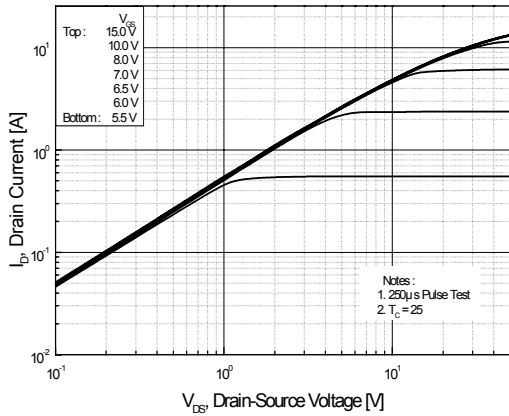

Figure 3. On-Resistance Variation vs. Drain Current and Gate Voltage

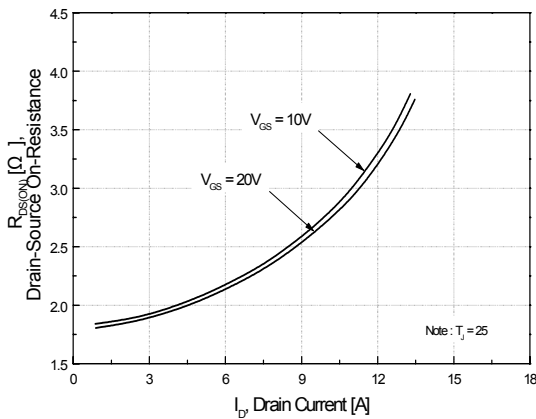

Figure 5. Capacitance Characteristics

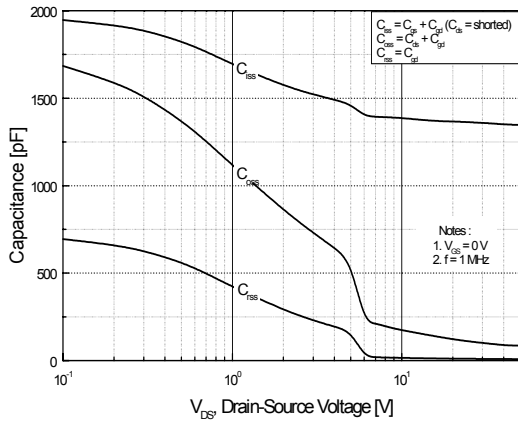

Figure 2. Transfer Characteristics

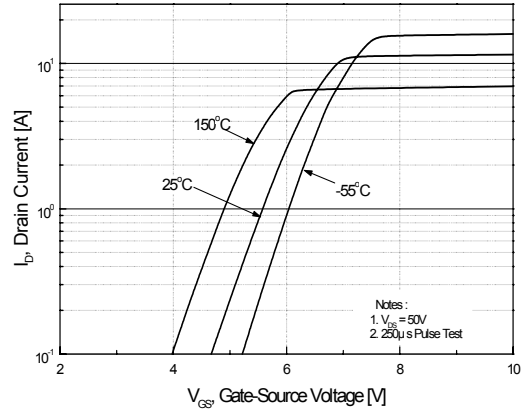

Figure 4. Body Diode Forward Voltage Variation vs. Source Current and Temperature

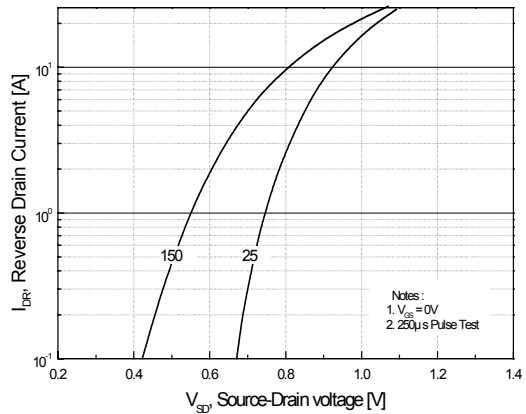
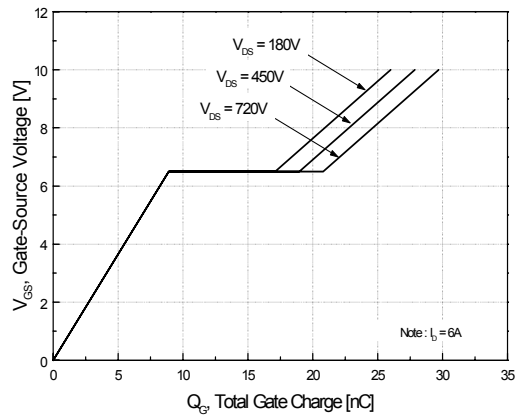

Figure 6. Gate Charge Characteristics



Typical Performance Characteristics (Continued)

Figure 7. Breakdown Voltage Variation vs. Temperature

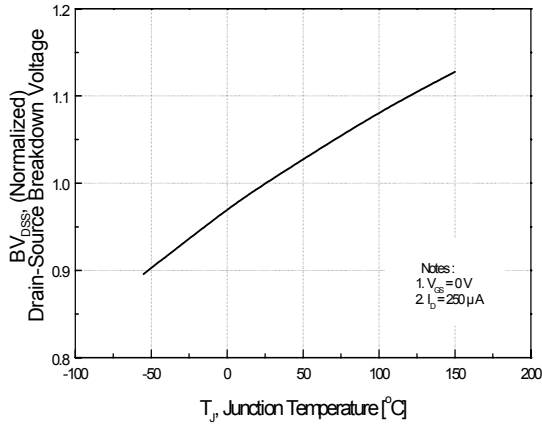

Figure 8. On-Resistance Variation vs. Temperature

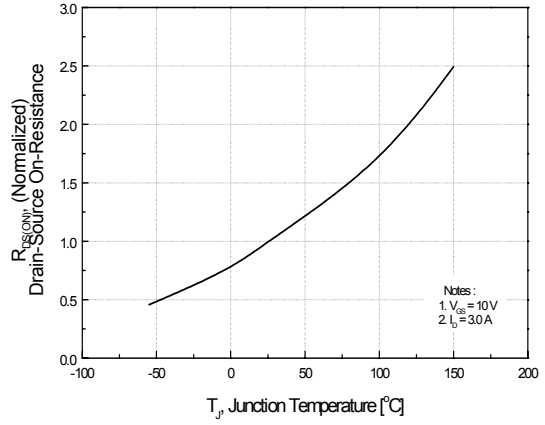

Figure 9. Maximum Safe Operating Area

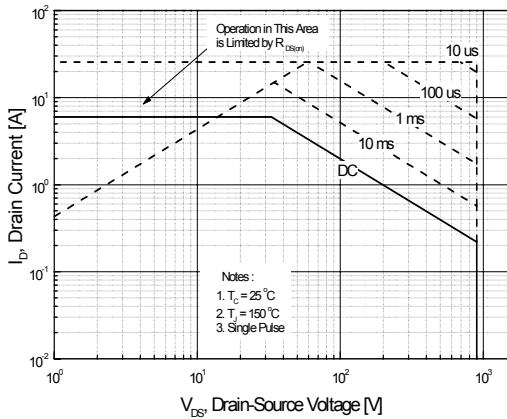

Figure 10. Maximum Drain Current vs. Case Temperature

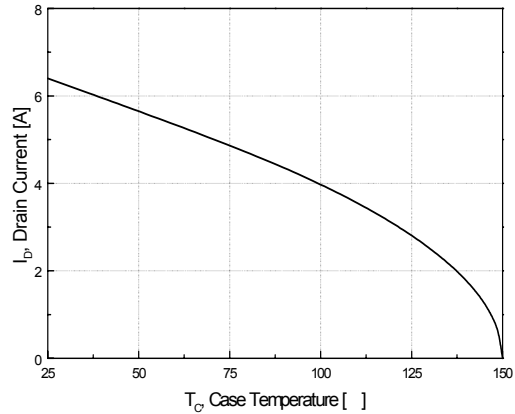
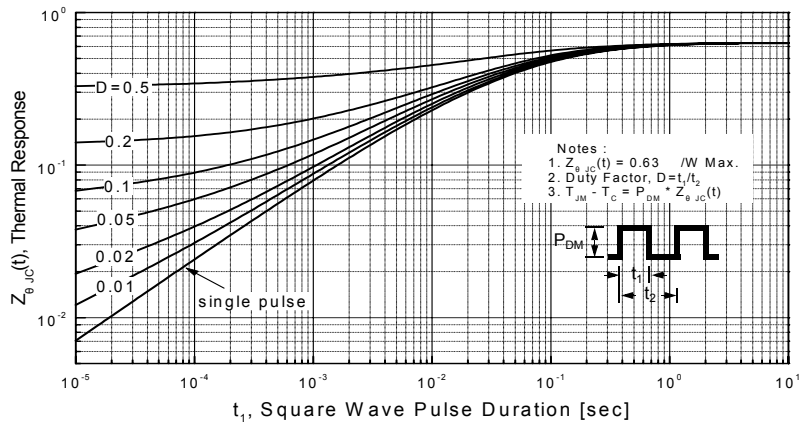

Figure 11. Transient Thermal Response Curve



Gate Charge Test Circuit & Waveform



Resistive Switching Test Circuit & Waveforms



Unclamped Inductive Switching Test Circuit & Waveforms



Peak Diode Recovery dv/dt Test Circuit & Waveforms



Mechanical Dimensions

TO-3P

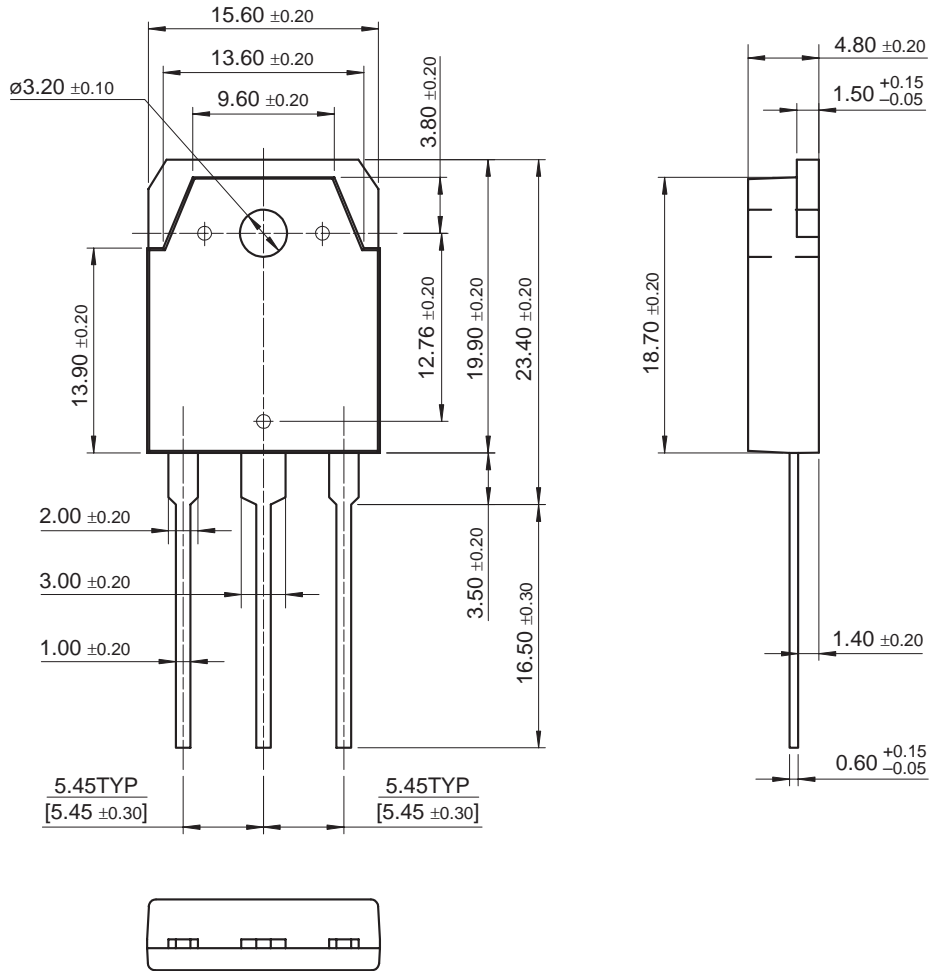

Dimensions in Millimeters

Mechanical Dimensions (Continued)

TO-3PN

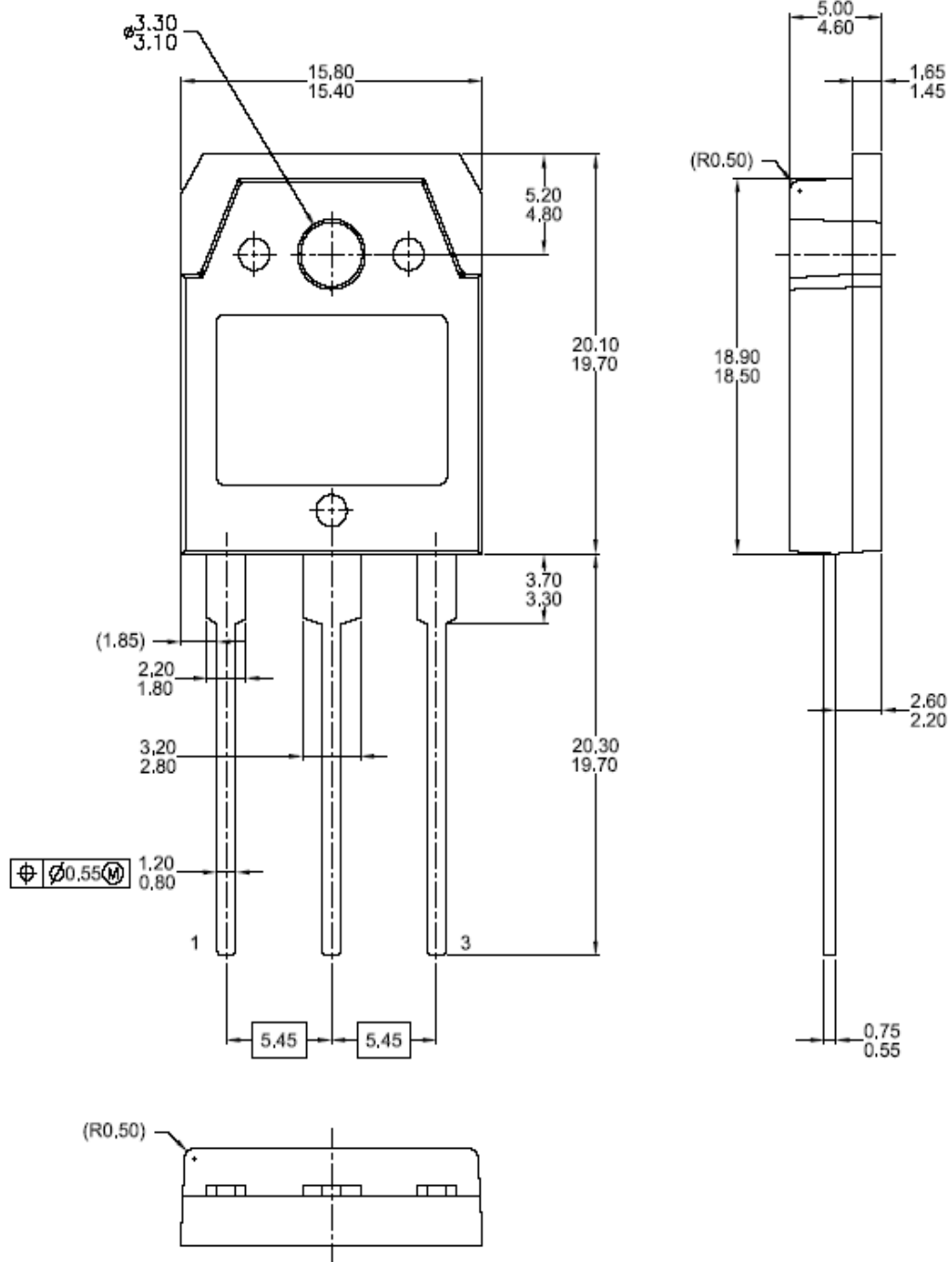

Dimensions in Millimeters

TRADEMARKS

The following are registered and unregistered trademarks Fairchild Semiconductor owns or is authorized to use and is not intended to be an exhaustive list of all such trademarks.

ACEx™	FACT Quiet Series™	OCX™	SILENT SWITCHER®	UniFET™
ActiveArray™	GlobalOptoisolator™	OCXPro™	SMART START™	UltraFET®
Bottomless™	GTO™	OPTOLOGIC®	SPM™	VCX™
Build it Now™	HiSeC™	OPTOPLANAR™	Stealth™	Wire™
CoolFET™	I ² C™	PACMAN™	SuperFET™	
CROSSVOLT™	i-Lo™	POP™	SuperSOT™-3	
DOME™	ImpliedDisconnect™	Power247™	SuperSOT™-6	
EcoSPARK™	IntelliMAX™	PowerEdge™	SuperSOT™-8	
E ² CMOS™	ISOPPLANAR™	PowerSaver™	SyncFET™	
EnSigna™	LittleFET™	PowerTrench®	TCM™	
FACT™	MICROCOUPLER™	QFET®	TinyBoost™	
FAST®	MicroFET™	QS™	TinyBuck™	
FASTr™	MicroPak™	QT Optoelectronics™	TinyPWM™	
FPS™	MICROWIRE™	Quiet Series™	TinyPower™	
FRFET™	MSX™	RapidConfigure™	TinyLogic®	
	MSXPro™	RapidConnect™	TINYOPTO™	
Across the board. Around the world.™		µSerDes™	TruTranslation™	
The Power Franchise®		ScalarPump™	UHC™	
Programmable Active Droop™				

DISCLAIMER

FAIRCHILD SEMICONDUCTOR RESERVES THE RIGHT TO MAKE CHANGES WITHOUT FURTHER NOTICE TO ANY PRODUCTS HEREIN TO IMPROVE RELIABILITY, FUNCTION OR DESIGN. FAIRCHILD DOES NOT ASSUME ANY LIABILITY ARISING OUT OF THE APPLICATION OR USE OF ANY PRODUCT OR CIRCUIT DESCRIBED HEREIN; NEITHER DOES IT CONVEY ANY LICENSE UNDER ITS PATENT RIGHTS, NOR THE RIGHTS OF OTHERS. THESE SPECIFICATIONS DO NOT EXPAND THE TERMS OF FAIRCHILD'S WORLDWIDE TERMS AND CONDITIONS, SPECIFICALLY THE WARRANTY THEREIN, WHICH COVERS THESE PRODUCTS.

LIFE SUPPORT POLICY

FAIRCHILD'S PRODUCTS ARE NOT AUTHORIZED FOR USE AS CRITICAL COMPONENTS IN LIFE SUPPORT DEVICES OR SYSTEMS WITHOUT THE EXPRESS WRITTEN APPROVAL OF FAIRCHILD SEMICONDUCTOR CORPORATION.

As used herein:

- Life support devices or systems are devices or systems which, (a) are intended for surgical implant into the body, or (b) support or sustain life, or (c) whose failure to perform when properly used in accordance with instructions for use provided in the labeling, can be reasonably expected to result in significant injury to the user.
- A critical component is any component of a life support device or system whose failure to perform can be reasonably expected to cause the failure of the life support device or system, or to affect its safety or effectiveness.

PRODUCT STATUS DEFINITIONS

Definition of Terms

Datasheet Identification	Product Status	Definition
Advance Information	Formative or In Design	This datasheet contains the design specifications for product development. Specifications may change in any manner without notice.
Preliminary	First Production	This datasheet contains preliminary data, and supplementary data will be published at a later date. Fairchild Semiconductor reserves the right to make changes at any time without notice in order to improve design.
No Identification Needed	Full Production	This datasheet contains final specifications. Fairchild Semiconductor reserves the right to make changes at any time without notice in order to improve design.
Obsolete	Not In Production	This datasheet contains specifications on a product that has been discontinued by Fairchild semiconductor. The datasheet is printed for reference information only.

Rev. I20

Данный компонент на территории Российской Федерации

Вы можете приобрести в компании MosChip.

Для оперативного оформления запроса Вам необходимо перейти по данной ссылке:

<http://moschip.ru/get-element>

Вы можете разместить у нас заказ для любого Вашего проекта, будь то серийное производство или разработка единичного прибора.

В нашем ассортименте представлены ведущие мировые производители активных и пассивных электронных компонентов.

Распределительные склады, находящиеся в России, Европе и в Китае, позволяют нам оперативно поставить необходимые компоненты в оптимальные для Вас сроки.

На всех этапах разработки и производства наши партнеры могут получить квалифицированную поддержку опытных инженеров.

Система менеджмента качества компании отвечает требованиям ISO 9001:2011

Офис по работе с юридическими лицами:

107023, г.Москва, Семеновский переулок, д.6, Бизнес-центр «АВС»

Телефон: +7 495 668-12-70 (многоканальный)

Факс: +7 495 668-12-70 (доб.304)

E-mail: info@moschip.ru

Skype отдела продаж:

moschip.ru_3	moschip.ru_6
moschip.ru_4	moschip.ru_7
moschip.ru_11	moschip.ru_8
moschip.ru_12	moschip.ru_9