

## ADR5040/ADR5041/ADR5043/ADR5044/ADR5045

### FEATURES

- Ultracompact SC70 and SOT-23 packages
- Low temperature coefficient: 75 ppm/°C (maximum)
- Pin compatible with LM4040/LM4050
- Initial accuracy:  $\pm 0.1\%$
- No external capacitor required
- Wide operating current range: 50  $\mu\text{A}$  to 15 mA
- Extended temperature range:  $-40^\circ\text{C}$  to  $+125^\circ\text{C}$

### APPLICATIONS

- Portable, battery-powered equipment
- Automotives
- Power supplies
- Data acquisition systems
- Instrumentation and process control
- Energy management

### GENERAL DESCRIPTION

Designed for space-critical applications, the ADR5040/ADR5041/ADR5043/ADR5044/ADR5045 are high precision shunt voltage references, housed in ultrasmall SC70 and SOT-23 packages. These voltage references are multipurpose, easy-to-use references that can be used in a vast array of applications. They feature low temperature drift, an initial accuracy of better than 0.1%, and fast settling time.

Available in output voltages of 2.048 V, 2.5 V, 3.0 V, 4.096 V, and 5.0 V, the advanced design of the ADR5040/ADR5041/ADR5043/ADR5044/ADR5045 eliminates the need for compensation by an external capacitor, yet the references are stable with any capacitive load. The minimum operating current increases from 50  $\mu\text{A}$  to a maximum of 15 mA. This low operating current and ease of use make these references ideally suited for handheld, battery-powered applications. This family of references has been characterized over the extended temperature range of  $-40^\circ\text{C}$  to  $+125^\circ\text{C}$ .

### PIN CONFIGURATION

ADR5040/ADR5041/  
ADR5043/ADR5044/  
ADR5045

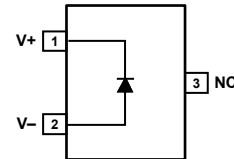

- NOTES  
1. NC = NO CONNECT.  
2. PIN 3 MUST BE LEFT FLOATING OR CONNECTED TO GROUND.

06524-001

Figure 1. 3-Lead SC70 (KS) and 3-Lead SOT-23 (RT)

Table 1. Selection Table

Part	Voltage (V)	Initial Accuracy (%)	Temperature Coefficient (ppm/°C)
ADR5040A	2.048	$\pm 0.2$	100
ADR5040B	2.048	$\pm 0.1$	75
ADR5041A	2.5	$\pm 0.2$	100
ADR5041B	2.5	$\pm 0.1$	75
ADR5043A	3.0	$\pm 0.2$	100
ADR5043B	3.0	$\pm 0.1$	75
ADR5044A	4.096	$\pm 0.2$	100
ADR5044B	4.096	$\pm 0.1$	75
ADR5045A	5.0	$\pm 0.2$	100
ADR5045B	5.0	$\pm 0.1$	75

#### Rev. A

Information furnished by Analog Devices is believed to be accurate and reliable. However, no responsibility is assumed by Analog Devices for its use, nor for any infringements of patents or other rights of third parties that may result from its use. Specifications subject to change without notice. No license is granted by implication or otherwise under any patent or patent rights of Analog Devices. Trademarks and registered trademarks are the property of their respective owners.

**TABLE OF CONTENTS**

Features .....	1	ADR5045 Electrical Characteristics .....	6
Applications.....	1	Absolute Maximum Ratings .....	7
Pin Configuration.....	1	Thermal Resistance .....	7
General Description .....	1	ESD Caution.....	7
Revision History .....	2	Typical Performance Characteristics .....	8
Specifications.....	4	Terminology .....	11
ADR5040 Electrical Characteristics .....	4	Theory of Operation .....	12
ADR5041 Electrical Characteristics .....	4	Applications Information.....	12
ADR5043 Electrical Characteristics .....	5	Outline Dimensions .....	14
ADR5044 Electrical Characteristics .....	5	Ordering Guide .....	14

**REVISION HISTORY**

**12/07—Rev. 0 to Rev. A**

Changes to Features.....	1
Changes to Initial Accuracy and Temperature Coefficient Parameters in Table 2 Through Table 6 .....	3
Updated Outline Dimensions .....	13
Changes to Ordering Guide .....	13

**1/07—Revision 0: Initial Version**

## SPECIFICATIONS

### ADR5040 ELECTRICAL CHARACTERISTICS

$I_{IN} = 50 \mu\text{A}$  to 15 mA,  $T_A = 25^\circ\text{C}$ , unless otherwise noted.

**Table 2.**

Parameter	Symbol	Conditions	Min	Typ	Max	Unit
OUTPUT VOLTAGE	$V_{OUT}$	$I_{IN} = 100 \mu\text{A}$				
Grade A			2.044	2.048	2.052	V
Grade B			2.046	2.048	2.050	V
INITIAL ACCURACY	$V_{OERR}$	$I_{IN} = 100 \mu\text{A}$				
Grade A			-4.096		+4.096	mV
					$\pm 0.2$	%
Grade B			-2.048		+2.048	mV
					$\pm 0.1$	%
TEMPERATURE COEFFICIENT <sup>1</sup>	$TCV_{OUT}$	$-40^\circ\text{C} < T_A < +125^\circ\text{C}$				
Grade A				10	100	ppm/ $^\circ\text{C}$
Grade B				10	75	ppm/ $^\circ\text{C}$
OUTPUT VOLTAGE CHANGE vs. $I_{IN}$	$\Delta V_R$	$I_{IN} = 50 \mu\text{A}$ to 1 mA $-40^\circ\text{C} < T_A < +125^\circ\text{C}$		0.4	1.75	mV
		$I_{IN} = 1 \text{ mA}$ to 15 mA $-40^\circ\text{C} < T_A < +125^\circ\text{C}$		4	8	mV
DYNAMIC OUTPUT IMPEDANCE	$(\Delta V_R / \Delta I_R)$	$I_{IN} = 50 \mu\text{A}$ to 15 mA			0.2	$\Omega$
MINIMUM OPERATING CURRENT	$I_{IN}$	$T_A = 25^\circ\text{C}$ $-40^\circ\text{C} < T_A < +125^\circ\text{C}$			50	$\mu\text{A}$
					60	$\mu\text{A}$
VOLTAGE NOISE	$e_N$	$I_{IN} = 100 \mu\text{A}$ ; 0.1 Hz to 10 Hz		2.8		$\mu\text{V rms}$
		$I_{IN} = 100 \mu\text{A}$ ; 10 Hz to 10 kHz		120		$\mu\text{V rms}$
TURN-ON SETTLING TIME	$t_R$	$C_{LOAD} = 0 \mu\text{F}$		28		$\mu\text{s}$
OUTPUT VOLTAGE HYSTERESIS	$\Delta V_{OUT\_HYS}$	$I_{IN} = 1 \text{ mA}$		40		ppm

<sup>1</sup> Guaranteed by design.

### ADR5041 ELECTRICAL CHARACTERISTICS

$I_{IN} = 50 \mu\text{A}$  to 15 mA,  $T_A = 25^\circ\text{C}$ , unless otherwise noted.

**Table 3.**

Parameter	Symbol	Conditions	Min	Typ	Max	Unit
OUTPUT VOLTAGE	$V_{OUT}$	$I_{IN} = 100 \mu\text{A}$				
Grade A			2.495	2.500	2.505	V
Grade B			2.4975	2.500	2.5025	V
INITIAL ACCURACY	$V_{OERR}$	$I_{IN} = 100 \mu\text{A}$				
Grade A			-5		+5	mV
					$\pm 0.2$	%
Grade B			-2.5		+2.5	mV
					$\pm 0.1$	%
TEMPERATURE COEFFICIENT <sup>1</sup>	$TCV_{OUT}$	$-40^\circ\text{C} < T_A < +125^\circ\text{C}$				
Grade A				10	100	ppm/ $^\circ\text{C}$
Grade B				10	75	ppm/ $^\circ\text{C}$
OUTPUT VOLTAGE CHANGE vs. $I_{IN}$	$\Delta V_R$	$I_{IN} = 50 \mu\text{A}$ to 1 mA $-40^\circ\text{C} < T_A < +125^\circ\text{C}$		0.5	1.8	mV
		$I_{IN} = 1 \text{ mA}$ to 15 mA $-40^\circ\text{C} < T_A < +125^\circ\text{C}$		4	8	mV

# ADR5040/ADR5041/ADR5043/ADR5044/ADR5045

Parameter	Symbol	Conditions	Min	Typ	Max	Unit
DYNAMIC OUTPUT IMPEDANCE	$(\Delta V_R/\Delta I_R)$	$I_{IN} = 50 \mu A$ to 15 mA			0.2	$\Omega$
MINIMUM OPERATING CURRENT	$I_{IN}$	$T_A = 25^\circ C$ $-40^\circ C < T_A < +125^\circ C$			50 60	$\mu A$ $\mu A$
VOLTAGE NOISE	$e_N$	$I_{IN} = 100 \mu A$ ; 0.1 Hz to 10 Hz $I_{IN} = 100 \mu A$ ; 10 Hz to 10 kHz		3.2 150		$\mu V$ rms $\mu V$ rms
TURN-ON SETTLING TIME	$t_R$	$C_{LOAD} = 0 \mu F$		35		$\mu s$
OUTPUT VOLTAGE HYSTERESIS	$\Delta V_{OUT\_HYS}$	$I_{IN} = 1$ mA		40		ppm

<sup>1</sup> Guaranteed by design.

## ADR5043 ELECTRICAL CHARACTERISTICS

$I_{IN} = 50 \mu A$  to 15 mA,  $T_A = 25^\circ C$ , unless otherwise noted.

Table 4.

Parameter	Symbol	Conditions	Min	Typ	Max	Unit
OUTPUT VOLTAGE	$V_{OUT}$	$I_{IN} = 100 \mu A$				
Grade A			2.994	3.000	3.006	V
Grade B			2.997	3.000	3.003	V
INITIAL ACCURACY	$V_{OERR}$	$I_{IN} = 100 \mu A$				
Grade A			-6		+6	mV
Grade B			-3		+3	mV
					$\pm 0.2$	%
					$\pm 0.1$	%
TEMPERATURE COEFFICIENT <sup>1</sup>	$TCV_{OUT}$	$-40^\circ C < T_A < +125^\circ C$				
Grade A				10	100	ppm/ $^\circ C$
Grade B				10	75	ppm/ $^\circ C$
OUTPUT VOLTAGE CHANGE vs. $I_{IN}$	$\Delta V_R$	$I_{IN} = 50 \mu A$ to 1 mA $-40^\circ C < T_A < +125^\circ C$ $I_{IN} = 1$ mA to 15 mA $-40^\circ C < T_A < +125^\circ C$				
				0.7	2.2	mV
				4	8	mV
DYNAMIC OUTPUT IMPEDANCE	$(\Delta V_R/\Delta I_R)$	$I_{IN} = 50 \mu A$ to 15 mA			0.2	$\Omega$
MINIMUM OPERATING CURRENT	$I_{IN}$	$T_A = 25^\circ C$ $-40^\circ C < T_A < +125^\circ C$			50 60	$\mu A$ $\mu A$
VOLTAGE NOISE	$e_N$	$I_{IN} = 100 \mu A$ ; 0.1 Hz to 10 Hz $I_{IN} = 100 \mu A$ ; 10 Hz to 10 kHz		4.3 180		$\mu V$ rms $\mu V$ rms
TURN-ON SETTLING TIME	$t_R$	$C_{LOAD} = 0 \mu F$		42		$\mu s$
OUTPUT VOLTAGE HYSTERESIS	$\Delta V_{OUT\_HYS}$	$I_{IN} = 1$ mA		40		ppm

<sup>1</sup> Guaranteed by design.

## ADR5044 ELECTRICAL CHARACTERISTICS

$I_{IN} = 50 \mu A$  to 15 mA,  $T_A = 25^\circ C$ , unless otherwise noted.

Table 5.

Parameter	Symbol	Conditions	Min	Typ	Max	Unit
OUTPUT VOLTAGE	$V_{OUT}$	$I_{IN} = 100 \mu A$				
Grade A			4.088	4.096	4.104	V
Grade B			4.092	4.096	4.100	V
INITIAL ACCURACY	$V_{OERR}$	$I_{IN} = 100 \mu A$				
Grade A			-8.192		+8.192	mV
Grade B			-4.096		+4.096	mV
					$\pm 0.2$	%
					$\pm 0.1$	%

# ADR5040/ADR5041/ADR5043/ADR5044/ADR5045

Parameter	Symbol	Conditions	Min	Typ	Max	Unit
TEMPERATURE COEFFICIENT <sup>1</sup> Grade A Grade B	TCV <sub>OUT</sub>	-40°C < T <sub>A</sub> < +125°C		10 10	100 75	ppm/°C ppm/°C
OUTPUT VOLTAGE CHANGE vs. I <sub>IN</sub>	ΔV <sub>R</sub>	I <sub>IN</sub> = 50 μA to 1 mA -40°C < T <sub>A</sub> < +125°C I <sub>IN</sub> = 1 mA to 15 mA -40°C < T <sub>A</sub> < +125°C		0.7 4	3 8	mV mV
DYNAMIC OUTPUT IMPEDANCE	(ΔV <sub>R</sub> /ΔI <sub>R</sub> )	I <sub>IN</sub> = 50 μA to 15 mA			0.2	Ω
MINIMUM OPERATING CURRENT	I <sub>IN</sub>	T <sub>A</sub> = 25°C -40°C < T <sub>A</sub> < +125°C			50 60	μA μA
VOLTAGE NOISE	e <sub>N</sub>	I <sub>IN</sub> = 100 μA; 0.1 Hz to 10 Hz I <sub>IN</sub> = 100 μA; 10 Hz to 10 kHz		5.4 240		μV rms μV rms
TURN-ON SETTLING TIME	t <sub>R</sub>	C <sub>LOAD</sub> = 0 μF		56		μs
OUTPUT VOLTAGE HYSTERESIS	ΔV <sub>OUT_HYS</sub>	I <sub>IN</sub> = 1 mA		40		ppm

<sup>1</sup> Guaranteed by design.

## ADR5045 ELECTRICAL CHARACTERISTICS

I<sub>IN</sub> = 50 μA to 15 mA, T<sub>A</sub> = 25°C, unless otherwise noted.

**Table 6.**

Parameter	Symbol	Conditions	Min	Typ	Max	Unit
OUTPUT VOLTAGE Grade A Grade B	V <sub>OUT</sub>	I <sub>IN</sub> = 100 μA	4.990 4.995	5.000 5.000	5.010 5.005	V V
INITIAL ACCURACY Grade A Grade B	V <sub>OERR</sub>	I <sub>IN</sub> = 100 μA	-10 -5		+10 ±0.2 +5 ±0.1	mV % mV %
TEMPERATURE COEFFICIENT <sup>1</sup> Grade A Grade B	TCV <sub>OUT</sub>	-40°C < T <sub>A</sub> < +125°C		10 10	100 75	ppm/°C ppm/°C
OUTPUT VOLTAGE CHANGE vs. I <sub>IN</sub>	ΔV <sub>R</sub>	I <sub>IN</sub> = 50 μA to 1 mA -40°C < T <sub>A</sub> < +125°C I <sub>IN</sub> = 1 mA to 15 mA -40°C < T <sub>A</sub> < +125°C		0.8 4	4 8	mV mV
DYNAMIC OUTPUT IMPEDANCE	(ΔV <sub>R</sub> /ΔI <sub>R</sub> )	I <sub>IN</sub> = 50 μA to 15 mA			0.2	Ω
MINIMUM OPERATING CURRENT	I <sub>IN</sub>	T <sub>A</sub> = 25°C -40°C < T <sub>A</sub> < +125°C			50 60	μA μA
VOLTAGE NOISE	e <sub>N</sub>	I <sub>IN</sub> = 100 μA; 0.1 Hz to 10 Hz I <sub>IN</sub> = 100 μA; 10 Hz to 10 kHz		6.6 280		μV rms μV rms
TURN-ON SETTLING TIME	t <sub>R</sub>	C <sub>LOAD</sub> = 0 μF		70		μs
OUTPUT VOLTAGE HYSTERESIS	ΔV <sub>OUT_HYS</sub>	I <sub>IN</sub> = 1 mA		40		ppm

<sup>1</sup> Guaranteed by design.

# ADR5040/ADR5041/ADR5043/ADR5044/ADR5045

## ABSOLUTE MAXIMUM RATINGS

Ratings apply at 25°C, unless otherwise noted.

Table 7.

Parameter	Rating
Reverse Current	25 mA
Forward Current	20 mA
Storage Temperature Range	-65°C to +150°C
Extended Temperature Range	-40°C to +125°C
Junction Temperature Range	-65°C to +150°C
Lead Temperature (Soldering, 60 sec)	300°C

Stresses above those listed under Absolute Maximum Ratings may cause permanent damage to the device. This is a stress rating only; functional operation of the device at these or any other conditions above those indicated in the operational section of this specification is not implied. Exposure to absolute maximum rating conditions for extended periods may affect device reliability.

## THERMAL RESISTANCE

$\theta_{JA}$  is specified for the worst-case conditions, that is, a device soldered in a circuit board for surface-mount packages.

Table 8. Thermal Resistance

Package Type	$\theta_{JA}$	$\theta_{JC}$	Unit
3-Lead SC70 (KS)	580.5	177.4	°C/W
3-Lead SOT-23 (RT)	270	102	°C/W

## ESD CAUTION



**ESD (electrostatic discharge) sensitive device.** Charged devices and circuit boards can discharge without detection. Although this product features patented or proprietary protection circuitry, damage may occur on devices subjected to high energy ESD. Therefore, proper ESD precautions should be taken to avoid performance degradation or loss of functionality.

## TYPICAL PERFORMANCE CHARACTERISTICS

$T_A = 25^\circ\text{C}$ ,  $I_{IN} = 100 \mu\text{A}$ , unless otherwise noted.

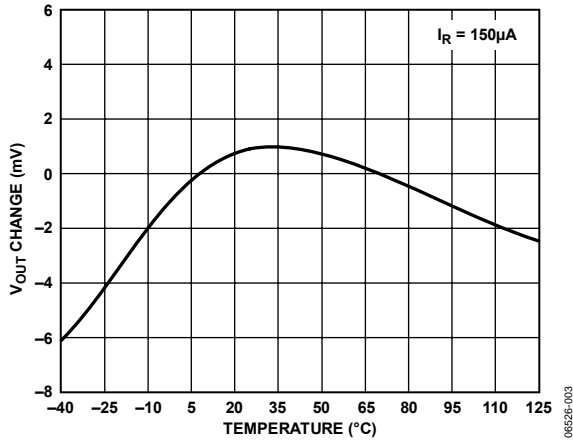

Figure 2. ADR5041  $V_{OUT}$  Change vs. Temperature



Figure 5. ADR5045  $V_{OUT}$  Change vs. Temperature

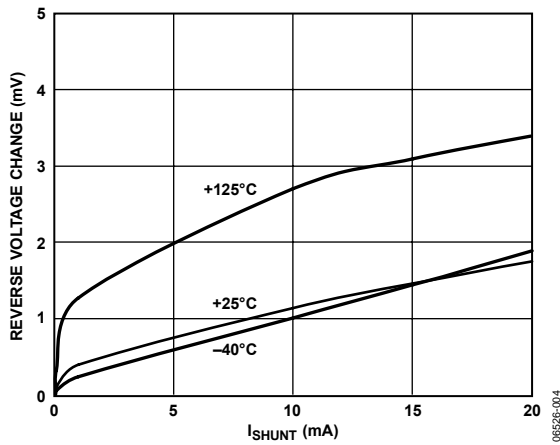

Figure 3. ADR5041 Reverse Voltage Change vs.  $I_{SHUNT}$



Figure 6. ADR5045 Reverse Voltage Change vs.  $I_{SHUNT}$

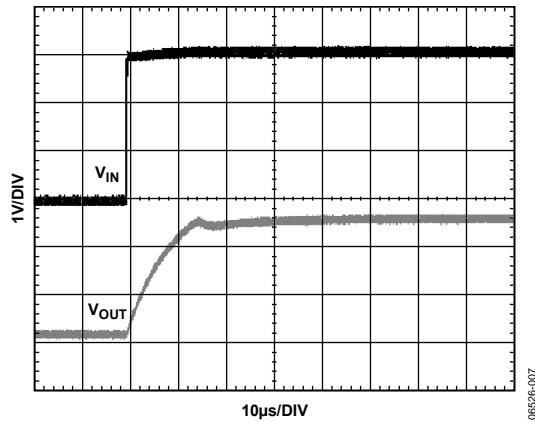

Figure 4. ADR5041 Start-Up Characteristics



Figure 7. ADR5045 Start-Up Characteristics

# ADR5040/ADR5041/ADR5043/ADR5044/ADR5045



Figure 8. ADR5041 Load Transient Response

06526-008



Figure 11. ADR5045 Load Transient Response

06526-011



Figure 9. ADR5041 Transient Response

06526-009



Figure 12. ADR5045 Transient Response

06526-012



Figure 10. ADR5041 Transient Response

06526-013



Figure 13. ADR5045 Transient Response

06526-016



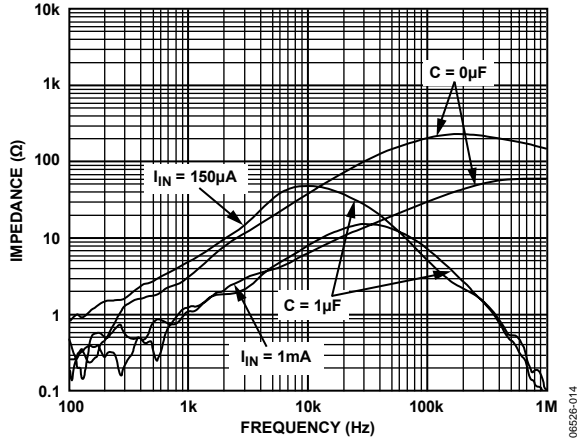

Figure 14. ADR5041 Output Impedance vs. Frequency

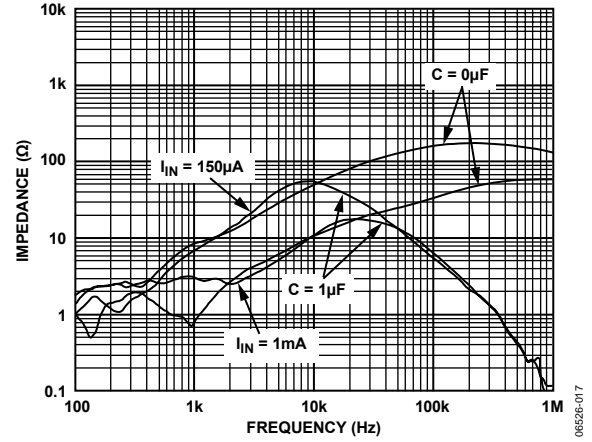

Figure 17. ADR5045 Output Impedance vs. Frequency

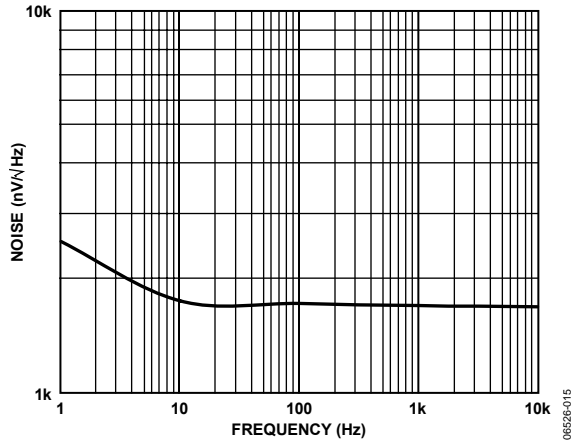

Figure 15. ADR5041 Voltage Noise Density

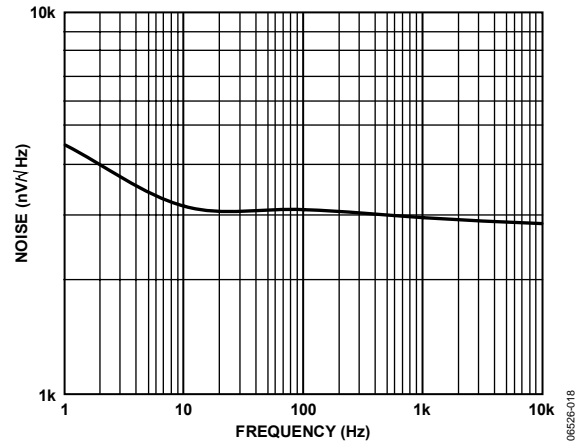

Figure 18. ADR5045 Voltage Noise Density

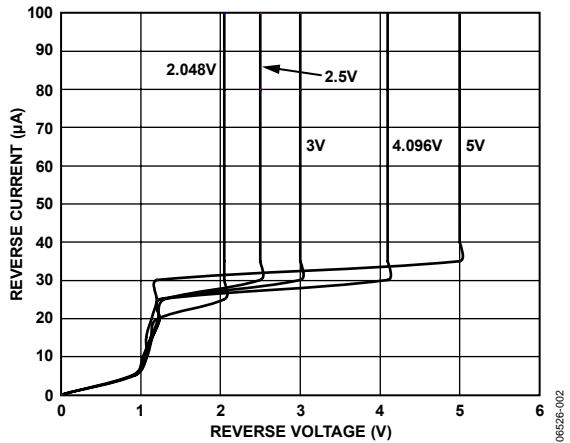

Figure 16. ADR504x Reverse Characteristics and Minimum Operating Current

## TERMINOLOGY

### Temperature Coefficient

The change in output voltage with respect to operating temperature changes. It is normalized by an output voltage of 25°C. This parameter is expressed in ppm/°C and is determined by the following equation:

$$TCV_{OUT} \left[ \frac{\text{ppm}}{^{\circ}\text{C}} \right] = \frac{V_{OUT}(T_2) - V_{OUT}(T_1)}{V_{OUT}(25^{\circ}\text{C}) \times (T_2 - T_1)} \times 10^6 \quad (1)$$

where:

$V_{OUT}(25^{\circ}\text{C}) = V_{OUT}$  at 25°C.

$V_{OUT}(T_1) = V_{OUT}$  at Temperature 1.

$V_{OUT}(T_2) = V_{OUT}$  at Temperature 2.

### Thermal Hysteresis

The change in output voltage after the device is cycled through temperatures ranging from +25°C to -40°C, then to +125°C, and back to +25°C. This is common in precision reference and is caused by thermal-mechanical package stress. Changes in environmental storage temperature, board mounting temperature, and the operating temperature are some of the factors that can contribute to thermal hysteresis. The following equation expresses a typical value from a sample of parts put through such a cycle:

$$V_{OUT\_HYS} = V_{OUT}(25^{\circ}\text{C}) - V_{OUT\_TC}$$

$$V_{OUT\_HYS} [\text{ppm}] = \frac{V_{OUT}(25^{\circ}\text{C}) - V_{OUT\_TC}}{V_{OUT}(25^{\circ}\text{C})} \times 10^6 \quad (2)$$

where:

$V_{OUT}(25^{\circ}\text{C}) = V_{OUT}$  at 25°C.

$V_{OUT\_TC} = V_{OUT}$  at 25°C after a temperature cycle from +25°C to -40°C, then to +125°C, and back to +25°C.

## THEORY OF OPERATION

The ADR504x family uses the band gap concept to produce a stable, low temperature coefficient voltage reference suitable for high accuracy data acquisition components and systems. The devices use the physical nature of a silicon transistor base-emitter voltage in the forward-biased operating region. All such transistors have approximately a  $-2 \text{ mV}/^\circ\text{C}$  temperature coefficient (TC), making them unsuitable for direct use as a low temperature coefficient reference. Extrapolation of the temperature characteristic of any one of these devices to absolute zero (with the collector current proportional to the absolute temperature), however, reveals that its  $V_{BE}$  approaches approximately the silicon band gap voltage. Therefore, if a voltage develops with an opposing temperature coefficient to sum the  $V_{BE}$ , a zero temperature coefficient reference results.

## APPLICATIONS INFORMATION

The ADR5040/ADR5041/ADR5043/ADR5044/ADR5045 are a series of precision shunt voltage references. They are designed to operate without an external capacitor between the positive and negative terminals. If a bypass capacitor is used to filter the supply, the references remain stable.

For a stable voltage, all shunt voltage references require an external bias resistor ( $R_{BIAS}$ ) between the supply voltage and the reference (see Figure 19). The  $R_{BIAS}$  sets the current that flows through the load ( $I_L$ ) and the reference ( $I_{IN}$ ). Because the load and the supply voltage can vary, the  $R_{BIAS}$  needs to be chosen based on the following considerations:

- $R_{BIAS}$  must be small enough to supply the minimum  $I_{IN}$  current to the ADR5040/ADR5041/ADR5043/ADR5044/ADR5045, even when the supply voltage is at its minimum value and the load current is at its maximum value.
- $R_{BIAS}$  must be large enough so that  $I_{IN}$  does not exceed 15 mA when the supply voltage is at its maximum value and the load current is at its minimum value.

Given these conditions,  $R_{BIAS}$  is determined by the supply voltage ( $V_S$ ), the ADR5040/ADR5041/ADR5043/ADR5044/ADR5045 load and operating current ( $I_L$  and  $I_{IN}$ ), and the ADR5040/ADR5041/ADR5043/ADR5044/ADR5045 output voltage ( $V_{OUT}$ ).

$$R_{BIAS} = \frac{V_S - V_{OUT}}{I_L + I_{IN}} \quad (3)$$

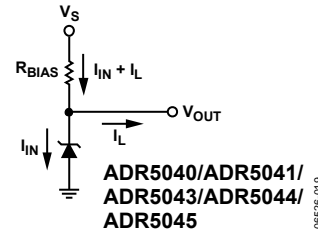

Figure 19. Shunt Reference

### Precision Negative Voltage Reference

The ADR5040/ADR5041/ADR5043/ADR5044/ADR5045 are suitable for applications where a precise negative voltage is desired. Figure 20 shows the ADR5045 configured to provide a negative output. Caution should be exercised in using a low temperature sensitive resistor to avoid errors from the resistor.

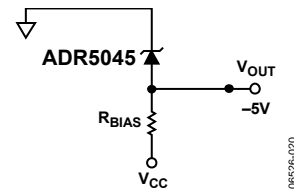

Figure 20. Negative Precision Reference Configuration

### Stacking the ADR504x for User-Definable Outputs

Multiple ADR504x parts can be stacked together to allow the user to obtain a desired higher voltage. Figure 21a shows three ADR5045 devices configured to give 15 V. The bias resistor,  $R_{BIAS}$ , is chosen using Equation 3, noting that the same bias current flows through all the shunt references in series. Figure 21b shows three ADR5045 devices stacked together to give  $-15 \text{ V}$ .  $R_{BIAS}$  is calculated in the same manner as before. Parts of different voltages can also be added together; that is, an ADR5041 and an ADR5045 can be added together to give an output of  $+7.5 \text{ V}$  or  $-7.5 \text{ V}$ , as desired. Note, however, that the initial accuracy error is the sum of the errors of all the stacked parts, as are the temperature coefficient and output voltage change vs. input current.

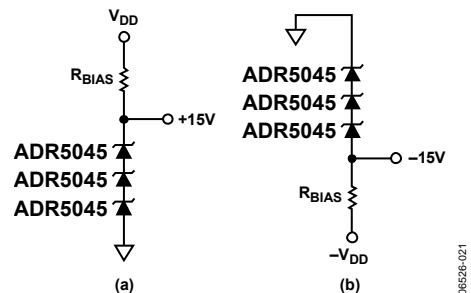

Figure 21.  $\pm 15 \text{ V}$  Output with Stacked ADR5045 Devices

# ADR5040/ADR5041/ADR5043/ADR5044/ADR5045

## Adjustable Precision Voltage Source

The ADR5040/ADR5041/ADR5043/ADR5044/ADR5045, combined with a precision low input bias op amp such as the AD8610, can be used to output a precise adjustable voltage. Figure 22 illustrates the implementation of this application using the ADR5040/ADR5041/ADR5043/ADR5044/ADR5045. The output of the op amp,  $V_{OUT}$ , is determined by the gain of the circuit, which is completely dependent on the resistors, R1 and R2.

$$V_{OUT} = (1 + R2/R1)V_{REF}$$

An additional capacitor, C1, in parallel with R2, can be added to filter out high frequency noise. The value of C1 is dependent on the value of R2.



Figure 22. Adjustable Voltage Source

06526-022

## Programmable Current Source

By using just a few ultrasmall and inexpensive parts, it is possible to build a programmable current source, as shown in Figure 23. The constant voltage on the gate of the transistor sets the current through the load. Varying the voltage on the gate changes the current. The AD5247 is a digital potentiometer with I<sup>2</sup>C<sup>®</sup> digital interface, and the AD8601 is a precision rail-to-rail input op amp. Each incremental step of the digital potentiometer increases or decreases the voltage at the noninverting input of the op amp. Therefore, this voltage varies with respect to the reference voltage.

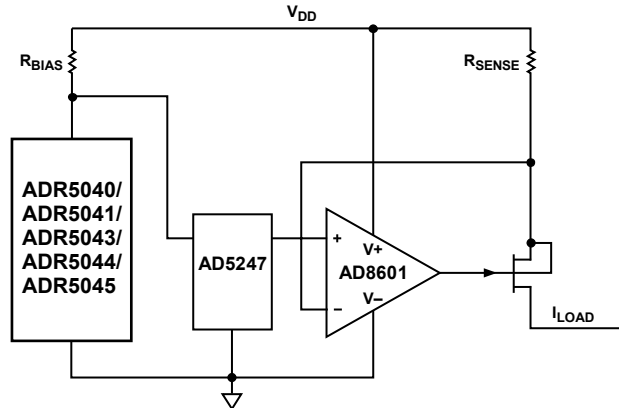

Figure 23. Programmable Current Source

06526-023

OUTLINE DIMENSIONS



ALL DIMENSIONS COMPLIANT WITH EIAJ SC70  
 Figure 24. 3-Lead Thin Shrink Small Outline Transistor Package [SC70]  
 (KS-3)  
 Dimensions shown in millimeters

111805-0

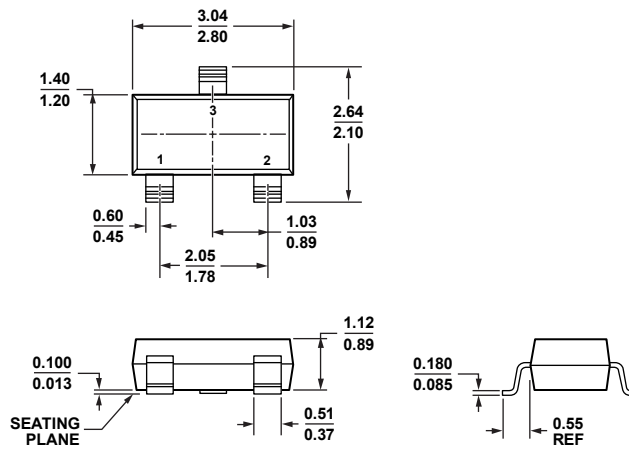

COMPLIANT TO JEDEC STANDARDS TO-236-AB  
 Figure 25. 3-Lead Small Outline Transistor Package [SOT-23-3]  
 (RT-3)  
 Dimensions shown in millimeters

082707-A

ORDERING GUIDE

Model	Output Voltage (V)	Initial Accuracy (mV)	Tempco Industrial (ppm/°C)	Temperature Range	Package Description	Package Option	Ordering Quantity	Branding
ADR5040AKSZ-R2 <sup>1</sup>	2.048	4.096	100	-40°C to +125°C	3-Lead SC70	KS-3	250	R2J
ADR5040AKSZ-REEL <sup>1</sup>	2.048	4.096	100	-40°C to +125°C	3-Lead SC70	KS-3	10,000	R2J
ADR5040AKSZ-REEL7 <sup>1</sup>	2.048	4.096	100	-40°C to +125°C	3-Lead SC70	KS-3	3,000	R2J
ADR5040ARTZ-R2 <sup>1</sup>	2.048	4.096	100	-40°C to +125°C	3-Lead SOT-23-3	RT-3	250	R2J
ADR5040ARTZ-REEL <sup>1</sup>	2.048	4.096	100	-40°C to +125°C	3-Lead SOT-23-3	RT-3	10,000	R2J
ADR5040ARTZ-REEL7 <sup>1</sup>	2.048	4.096	100	-40°C to +125°C	3-Lead SOT-23-3	RT-3	3,000	R2J
ADR5040BKSZ-R2 <sup>1</sup>	2.048	2.048	75	-40°C to +125°C	3-Lead SC70	KS-3	250	R2L
ADR5040BKSZ-REEL7 <sup>1</sup>	2.048	2.048	75	-40°C to +125°C	3-Lead SC70	KS-3	3,000	R2L
ADR5040BRTZ-R2 <sup>1</sup>	2.048	2.048	75	-40°C to +125°C	3-Lead SOT-23-3	RT-3	250	R2L
ADR5040BRTZ-REEL7 <sup>1</sup>	2.048	2.048	75	-40°C to +125°C	3-Lead SOT-23-3	RT-3	3,000	R2L

# ADR5040/ADR5041/ADR5043/ADR5044/ADR5045

Model	Output Voltage (V)	Initial Accuracy (mV)	Tempco Industrial (ppm/°C)	Temperature Range	Package Description	Package Option	Ordering Quantity	Branding
ADR5041AKSZ-R2 <sup>1</sup>	2.500	5	100	-40°C to +125°C	3-Lead SC70	KS-3	250	R2N
ADR5041AKSZ-REEL <sup>1</sup>	2.500	5	100	-40°C to +125°C	3-Lead SC70	KS-3	10,000	R2N
ADR5041AKSZ-REEL7 <sup>1</sup>	2.500	5	100	-40°C to +125°C	3-Lead SC70	KS-3	3,000	R2N
ADR5041ARTZ-R2 <sup>1</sup>	2.500	5	100	-40°C to +125°C	3-Lead SOT-23-3	RT-3	250	R2N
ADR5041ARTZ-REEL <sup>1</sup>	2.500	5	100	-40°C to +125°C	3-Lead SOT-23-3	RT-3	10,000	R2N
ADR5041ARTZ-REEL7 <sup>1</sup>	2.500	5	100	-40°C to +125°C	3-Lead SOT-23-3	RT-3	3,000	R2N
ADR5041BKSZ-R2 <sup>1</sup>	2.500	2.5	75	-40°C to +125°C	3-Lead SC70	KS-3	250	R2Q
ADR5041BKSZ-REEL7 <sup>1</sup>	2.500	2.5	75	-40°C to +125°C	3-Lead SC70	KS-3	3,000	R2Q
ADR5041BRTZ-R2 <sup>1</sup>	2.500	2.5	75	-40°C to +125°C	3-Lead SOT-23-3	RT-3	250	R2Q
ADR5041BRTZ-REEL7 <sup>1</sup>	2.500	2.5	75	-40°C to +125°C	3-Lead SOT-23-3	RT-3	3,000	R2Q
ADR5043AKSZ-R2 <sup>1</sup>	3.0	6	100	-40°C to +125°C	3-Lead SC70	KS-3	250	R2S
ADR5043AKSZ-REEL <sup>1</sup>	3.0	6	100	-40°C to +125°C	3-Lead SC70	KS-3	10,000	R2S
ADR5043AKSZ-REEL7 <sup>1</sup>	3.0	6	100	-40°C to +125°C	3-Lead SC70	KS-3	3,000	R2S
ADR5043ARTZ-R2 <sup>1</sup>	3.0	6	100	-40°C to +125°C	3-Lead SOT-23-3	RT-3	250	R2S
ADR5043ARTZ-REEL <sup>1</sup>	3.0	6	100	-40°C to +125°C	3-Lead SOT-23-3	RT-3	10,000	R2S
ADR5043ARTZ-REEL7 <sup>1</sup>	3.0	6	100	-40°C to +125°C	3-Lead SOT-23-3	RT-3	3,000	R2S
ADR5043BKSZ-R2 <sup>1</sup>	3.0	3	75	-40°C to +125°C	3-Lead SC70	KS-3	250	R2U
ADR5043BKSZ-REEL7 <sup>1</sup>	3.0	3	75	-40°C to +125°C	3-Lead SC70	KS-3	3,000	R2U
ADR5043BRTZ-R2 <sup>1</sup>	3.0	3	75	-40°C to +125°C	3-Lead SOT-23-3	RT-3	250	R2U
ADR5043BRTZ-REEL7 <sup>1</sup>	3.0	3	75	-40°C to +125°C	3-Lead SOT-23-3	RT-3	3,000	R2U
ADR5044AKSZ-R2 <sup>1</sup>	4.096	8.192	100	-40°C to +125°C	3-Lead SC70	KS-3	250	R2W
ADR5044AKSZ-REEL <sup>1</sup>	4.096	8.192	100	-40°C to +125°C	3-Lead SC70	KS-3	10,000	R2W
ADR5044AKSZ-REEL7 <sup>1</sup>	4.096	8.192	100	-40°C to +125°C	3-Lead SC70	KS-3	3,000	R2W
ADR5044ARTZ-R2 <sup>1</sup>	4.096	8.192	100	-40°C to +125°C	3-Lead SOT-23-3	RT-3	250	R2W
ADR5044ARTZ-REEL <sup>1</sup>	4.096	8.192	100	-40°C to +125°C	3-Lead SOT-23-3	RT-3	10,000	R2W
ADR5044ARTZ-REEL7 <sup>1</sup>	4.096	8.192	100	-40°C to +125°C	3-Lead SOT-23-3	RT-3	3,000	R2W
ADR5044BKSZ-R2 <sup>1</sup>	4.096	4.096	75	-40°C to +125°C	3-Lead SC70	KS-3	250	R2Y
ADR5044BKSZ-REEL7 <sup>1</sup>	4.096	4.096	75	-40°C to +125°C	3-Lead SC70	KS-3	3,000	R2Y
ADR5044BRTZ-R2 <sup>1</sup>	4.096	4.096	75	-40°C to +125°C	3-Lead SOT-23-3	RT-3	250	R2Y
ADR5044BRTZ-REEL7 <sup>1</sup>	4.096	4.096	75	-40°C to +125°C	3-Lead SOT-23-3	RT-3	3,000	R2Y
ADR5045AKSZ-R2 <sup>1</sup>	5.0	10	100	-40°C to +125°C	3-Lead SC70	KS-3	250	R30
ADR5045AKSZ-REEL <sup>1</sup>	5.0	10	100	-40°C to +125°C	3-Lead SC70	KS-3	10,000	R30
ADR5045AKSZ-REEL7 <sup>1</sup>	5.0	10	100	-40°C to +125°C	3-Lead SC70	KS-3	3,000	R30
ADR5045ARTZ-R2 <sup>1</sup>	5.0	10	100	-40°C to +125°C	3-Lead SOT-23-3	RT-3	250	R30
ADR5045ARTZ-REEL <sup>1</sup>	5.0	10	100	-40°C to +125°C	3-Lead SOT-23-3	RT-3	10,000	R30
ADR5045ARTZ-REEL7 <sup>1</sup>	5.0	10	100	-40°C to +125°C	3-Lead SOT-23-3	RT-3	3,000	R30
ADR5045BKSZ-R2 <sup>1</sup>	5.0	5	75	-40°C to +125°C	3-Lead SC70	KS-3	250	R32
ADR5045BKSZ-REEL7 <sup>1</sup>	5.0	5	75	-40°C to +125°C	3-Lead SC70	KS-3	3,000	R32
ADR5045BRTZ-R2 <sup>1</sup>	5.0	5	75	-40°C to +125°C	3-Lead SOT-23-3	RT-3	250	R32
ADR5045BRTZ-REEL7 <sup>1</sup>	5.0	5	75	-40°C to +125°C	3-Lead SOT-23-3	RT-3	3,000	R32

<sup>1</sup> Z = RoHS Compliant Part.

**NOTES**

**NOTES**

Purchase of licensed I<sup>2</sup>C components of Analog Devices or one of its sublicensed Associated Companies conveys a license for the purchaser under the Philips I<sup>2</sup>C Patent Rights to use these components in an I<sup>2</sup>C system, provided that the system conforms to the I<sup>2</sup>C Standard Specification as defined by Philips.



## Данный компонент на территории Российской Федерации

### Вы можете приобрести в компании MosChip.

Для оперативного оформления запроса Вам необходимо перейти по данной ссылке:

<http://moschip.ru/get-element>

Вы можете разместить у нас заказ для любого Вашего проекта, будь то серийное производство или разработка единичного прибора.

В нашем ассортименте представлены ведущие мировые производители активных и пассивных электронных компонентов.

Нашей специализацией является поставка электронной компонентной базы двойного назначения, продукции таких производителей как XILINX, Intel (ex.ALTERA), Vicor, Microchip, Texas Instruments, Analog Devices, Mini-Circuits, Amphenol, Glenair.

Сотрудничество с глобальными дистрибьюторами электронных компонентов, предоставляет возможность заказывать и получать с международных складов практически любой перечень компонентов в оптимальные для Вас сроки.

На всех этапах разработки и производства наши партнеры могут получить квалифицированную поддержку опытных инженеров.

Система менеджмента качества компании отвечает требованиям в соответствии с ГОСТ Р ИСО 9001, ГОСТ РВ 0015-002 и ЭС РД 009

### Офис по работе с юридическими лицами:

105318, г.Москва, ул.Щербаковская д.3, офис 1107, 1118, ДЦ «Щербаковский»

Телефон: +7 495 668-12-70 (многоканальный)

Факс: +7 495 668-12-70 (доб.304)

E-mail: [info@moschip.ru](mailto:info@moschip.ru)

Skype отдела продаж:

moschip.ru

moschip.ru\_4

moschip.ru\_6

moschip.ru\_9