

PWM/VFM step-down DC/DC Converter

NO.EA-096-061102

OUTLINE

The R1224N Series are CMOS-based PWM step-down DC/DC Converter controllers with low supply current.

Each of these ICs consists of an oscillator, a PWM control circuit, a reference voltage unit, an error amplifier, a phase compensation circuit, a soft-start circuit, a protection circuit, a PWM/VFM alternative circuit, a chip enable circuit, resistors for output voltage detect, and input voltage detect circuit. A low ripple, high efficiency step-down DC/DC converter can be easily composed of this IC with only several external components, or a power-transistor, an inductor, a diode and capacitors. Output Voltage is fixed or can be adjusted with external resistors (Adjustable types are without PWM/VFM alternative circuit).

With a PWM/VFM alternative circuit, when the load current is small, the operation is automatically switching into the VFM oscillator from PWM oscillator. Therefore, the efficiency at small load current is improved. Several types of the R1224Nxxx, which are without a PWM/VFM alternative circuit, are also available.

If the term of maximum duty cycle keeps on a certain time, the embedded protection circuit works. The protection circuit is Reset-type protection circuit, and it works to restart the operation with soft-start and repeat this operation until maximum duty cycle condition is released. When the cause of large load current or something else is removed, the operation is automatically released and returns to normal operation.

Further, built-in UVLO function works when the input voltage is equal or less than UVLO threshold, it makes this IC be standby and suppresses the consumption current and avoid an unstable operation.

FEATURES

- Supply Current Typ. 20 μ A (R1224Nxx2E/F/M/L, R1224N102M)
Typ. 30 μ A (R1224Nxx2G, R1224N102G)
Typ. 40 μ A (R1224Nxx2H, R1224N102H)
- Standby Current Typ. 0 μ A
- Input Voltage Range 2.3V~18.5V
- Output Voltage Range..... 1.2V to 6.0V (R1224Nxx2x)
1.0V to V_{IN} (R1224N102x)
- Output Voltage Accuracy..... $\pm 2.0\%$
- Oscillator Frequency Typ. 180kHz (R1224Nxx2M, R1224N102M)
Typ. 300kHz (R1224Nxx2E/G, R1224N102G)
Typ. 500kHz (R1224Nxx2F/H, R1224N102H)
- Efficiency Typ. 90%
- Low Temperature-Drift Coefficient of Output Voltage..... Typ. ± 100 ppm/ $^{\circ}$ C
- Package SOT-23-5
- Built-in Soft-start Function..... Typ. 10ms
- Built-in Current Limit Circuit

APPLICATIONS

- Power source for hand-held communication equipment, cameras, video instruments such as VCRs, camcorders.
- Power source for battery-powered equipment.
- Power source for household electrical appliances.

BLOCK DIAGRAM

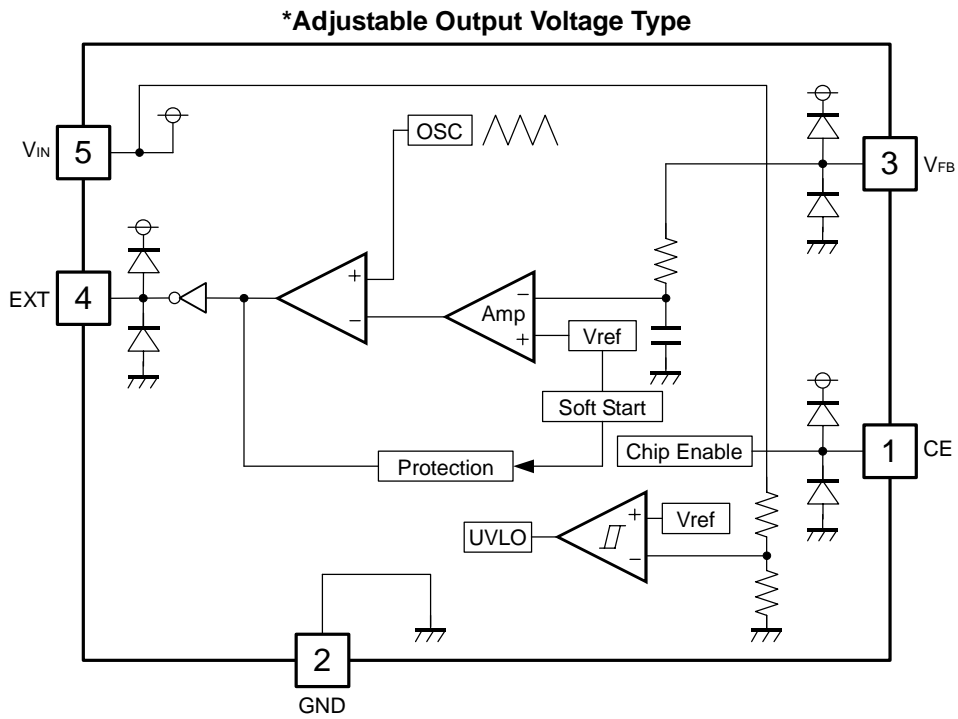
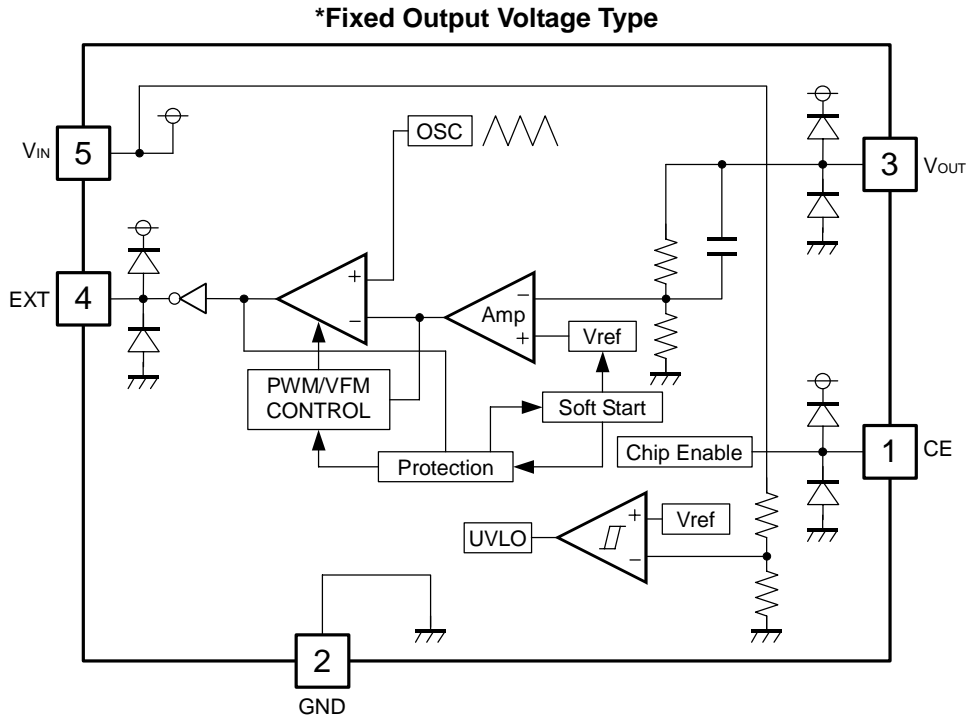

SELECTION GUIDE

In the R1224N Series, the output voltage, the oscillator frequency, the optional function, and the taping type for the ICs can be selected at the user's request.

The selection can be made with designating the part number as shown below;

R1224N \overbrace{xx}^a $\overbrace{2x}^b$ - \overbrace{xx}^c - \overbrace{x}^d ← Part Number
 ↑ ↑ ↑ ↑ ↑ ↑
 a b c d e f

| Code | Contents |
|------|---|
| a | Designation of Package Type; N: SOT-23-5 |
| b | Setting Output Voltage (V_{out}): Stepwise setting with a step of 0.1V in the range of 1.2V to 6.0V is possible. Adjustable type; a=10 means Reference Voltage=1.0V Optional Function is G/H/M. |
| c | 2: fixed |
| d | Designation of Optional Function E : 300kHz, with a PWM/VFM alternative circuit F : 500kHz, with a PWM/VFM alternative circuit G : 300kHz, without a PWM/VFM alternative circuit H : 500kHz, without a PWM/VFM alternative circuit L : 180kHz, with a PWM/VFM alternative circuit M : 180kHz, without a PWM/VFM alternative circuit |
| e | Designation of Taping Type; (Refer to Taping Specification)"TR" is prescribed as a standard. |
| f | Designation of Composition of pin plating -F: Lead free plating |

PIN CONFIGURATIO

- SOT-23-5

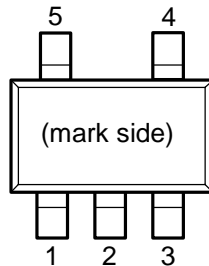

PIN DESCRIPTION

| Pin No | Symbol | Pin Description |
|--------|------------------------|--|
| 1 | CE | Chip Enable Pin ("H" Active) |
| 2 | GND | Ground Pin |
| 3 | V_{OUT} (V_{FB}) | Pin for Monitoring Output Voltage (Feedback Voltage) |
| 4 | EXT | External Transistor Drive Pin (CMOS Output) |
| 5 | V_{IN} | Power Supply Pin |

ABSOLUTE MAXIMUM RATINGS

| Symbol | Item | Rating | Unit |
|-----------|---------------------------------------|----------------------|--------------------|
| V_{IN} | V_{IN} Supply Voltage | 20 | V |
| V_{EXT} | EXT Pin Output Voltage | -0.3 to $V_{IN}+0.3$ | V |
| V_{CE} | CE Pin Input Voltage | -0.3 to $V_{IN}+0.3$ | V |
| V_{OUT} | V_{OUT}/V_{FB} Pin Input Voltage | -0.3 to $V_{IN}+0.3$ | V |
| I_{EXT} | EXT Pin Inductor Drive Output Current | ± 50 | A |
| P_D | Power Dissipation (SOT-23-5)* | 420 | mW |
| T_{opt} | Operating Temperature Range | -40 to +85 | $^{\circ}\text{C}$ |
| T_{stg} | Storage Temperature Range | -55 to +125 | $^{\circ}\text{C}$ |

*) For Power Dissipation, please refer to PACKAGE INFORMATION to be described.

ELECTRICAL CHARACTERISTICS

• R1224Nxx2X (X=E/F/G/H/L/M) except R1224N102X

T_{opt}=25°C

| Symbol | Item | Conditions | Min. | Typ. | Max. | Unit |
|--|---|--|---------------------------|----------------------------|---------------------------|--------|
| V _{IN} | Operating Input Voltage | | 2.3 | | 18.5 | V |
| V _{OUT} | Step-down Output Voltage | V _{IN} =V _{CE} =V _{SET} +1.5V, I _{OUT} =-100mA When V _{SET} ≤ 1.5V, V _{IN} =V _{CE} =3.0V | V _{SET} ×0.98 | V _{SET} | V _{SET} ×1.02 | V |
| ΔV _{OUT} / ΔT _{opt} | Step-down Output Voltage Temperature Coefficient | -40°C ≤ T _{opt} ≤ 85°C | | ±100 | | ppm/°C |
| f _{osc} | Oscillator Frequency | V _{IN} =V _{CE} =V _{SET} +1.5V, I _{OUT} =-100mA When V _{SET} ≤ 1.5, V _{IN} =V _{CE} =3.0V L/M Version E/G Version F/H Version | 144 240 400 | 180 300 500 | 216 360 600 | kHz |
| Δf _{osc} / ΔT _{opt} | Oscillator Frequency Temperature Coefficient | -40°C ≤ T _{opt} ≤ 85°C | | ±0.2 | | %/°C |
| I _{DD1} | Supply Current 1 | V _{IN} =V _{CE} =V _{OUT} =18.5V E/F/L/M Version G version H version | | 20 30 40 | 50 60 80 | μA |
| I _{standby} | Standby Current | V _{IN} =18.5V, V _{CE} =0V, V _{OUT} =0V | | 0.0 | 0.5 | μA |
| I _{EXTH} | EXT "H" Output Current | V _{IN} =8V, V _{EXT} =7.9V, V _{OUT} =8V, V _{CE} =8V | | -17 | -10 | mA |
| I _{EXTL} | EXT "L" Output Current | V _{IN} =8V, V _{EXT} =0.1V, V _{OUT} =0V, V _{CE} =8V | 20 | 30 | | mA |
| I _{CEH} | CE "H" Input Current | V _{IN} =V _{CE} =V _{OUT} =18.5V | | 0.0 | 0.5 | μA |
| I _{CEL} | CE "L" Input Current | V _{IN} =V _{OUT} =18.5V, V _{CE} =0V | -0.5 | 0.0 | | μA |
| V _{CEH} | CE "H" Input Voltage | V _{IN} =8V, V _{OUT} =0V | 1.5 | | | V |
| V _{CEL} | CE "L" Input Voltage | V _{IN} =8V, V _{OUT} =0V | | | 0.3 | V |
| Maxdty | Oscillator Maximum Duty Cycle | | 100 | | | % |
| VFMdty | VFM Duty Cycle | E/F/L Version | | 35 | | % |
| V _{UVLO1} | UVLO Voltage | V _{IN} =V _{CE} =2.5V to 1.5V, V _{OUT} =0V | 1.8 | 2.0 | 2.2 | V |
| V _{UVLO2} | UVLO Release Voltage | V _{IN} =V _{CE} =1.5V to 2.5V, V _{OUT} =0V | | V _{UVLO1} +0.1 | 2.3 | V |
| t _{start} | Delay Time by Soft-Start function | V _{IN} =V _{SET} +1.5V, I _{OUT} =-10mA V _{CE} =0V→V _{SET} +1.5V | 5 | 10 | 20 | ms |
| t _{prot} | Delay Time for protection circuit | V _{IN} =V _{CE} =V _{SET} +1.5V V _{OUT} =V _{SET} +1.5V→0V | 5 | 15 | 30 | ms |

R1224N

• R1224N102X (X=G/H/M)

T_{opt}=25°C

| Symbol | Item | Conditions | Min. | Typ. | Max. | Unit |
|---|--|--|-------------------|----------------------------|-------------------|--------|
| V _{IN} | Operating Input Voltage | | 2.3 | | 18.5 | V |
| V _{FB} | Feedback Voltage | V _{IN} =V _{CE} =3.5V, I _{FB} =-100mA | 0.98 | 1.00 | 1.02 | V |
| $\frac{\Delta V_{FB}}{\Delta T_{opt}}$ | Feedback Voltage Temperature Coefficient | -40°C ≤ T _{opt} ≤ 85°C | | ±100 | | ppm/°C |
| f _{osc} | Oscillator Frequency | V _{IN} =V _{CE} =3.5V, I _{FB} =-100mA M Version G Version H Version | 144 240 400 | 180 300 500 | 216 360 600 | kHz |
| $\frac{\Delta f_{osc}}{\Delta T_{opt}}$ | Oscillator Frequency Temperature Coefficient | -40°C ≤ T _{opt} ≤ 85°C | | ±0.2 | | %/°C |
| I _{DD1} | Supply Current 1 | V _{IN} =V _{CE} =V _{FB} =18.5V M Version G Version H Version | | 20 30 40 | 50 60 80 | μA |
| I _{standby} | Standby Current | V _{IN} =18.5V, V _{CE} =0V, V _{FB} =0V | | 0.0 | 0.5 | μA |
| I _{EXTH} | EXT "H" Output Current | V _{IN} =8V, V _{EXT} =7.9V, V _{FB} =8V, V _{CE} =8V | | -17 | -10 | mA |
| I _{EXTL} | EXT "L" Output Current | V _{IN} =8V, V _{EXT} =0.1V, V _{FB} =0V, V _{CE} =8V | 20 | 30 | | mA |
| I _{CEH} | CE "H" Input Current | V _{IN} =V _{CE} =V _{FB} =18.5V | | 0.0 | 0.5 | μA |
| I _{CEL} | CE "L" Input Current | V _{IN} =V _{FB} =18.5V, V _{CE} =0V | -0.5 | 0.0 | | μA |
| V _{CEH} | CE "H" Input Voltage | V _{IN} =8V, V _{FB} =0V | 1.5 | | | V |
| V _{CEL} | CE "L" Input Voltage | V _{IN} =8V, V _{FB} =0V | | | 0.3 | V |
| Maxdty | Oscillator Maximum Duty Cycle | | 100 | | | % |
| V _{UVLO1} | UVLO Voltage | V _{IN} =V _{CE} =2.5V to 1.5V, V _{FB} =0V | 1.8 | 2.0 | 2.2 | V |
| V _{UVLO2} | UVLO Release Voltage | V _{IN} =V _{CE} =1.5V to 2.5V, V _{FB} =0V | | V _{UVLO1} +0.1 | 2.3 | V |
| t _{start} | Delay Time by Soft-Start function | V _{IN} =2.5V, I _{FB} =-10mA V _{CE} =0V→2.5V | 5 | 10 | 20 | ms |
| t _{prot} | Delay Time for protection circuit | V _{IN} =V _{CE} =2.5V V _{FB} =2.5V→0V | 5 | 15 | 30 | ms |

TYPICAL APPLICATION AND APPLICATION HINTS

(1) Fixed Output Voltage Type (R1224Nxx2E/F/G/H/L/M except xx=10)

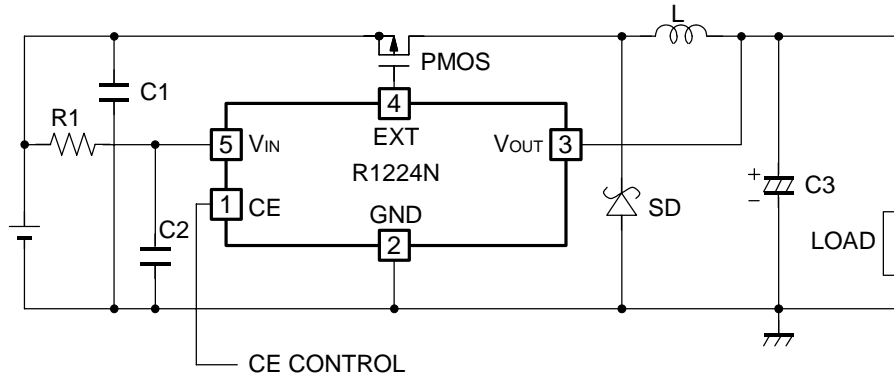

PMOS: HAT1044M (Hitachi) L : CR105-270MC (Sumida, 27 μ H)
 SD1 : RB063L-30 (Rohm) C3 : 47 μ F (Tantalum Type)
 C1 : 10 μ F (Ceramic Type) C2 : 0.1 μ F (Ceramic Type)
 R1 : 10 Ω

(2) Adjustable Output Type (R1224N102G/H/M) Example: Output Voltage=3.2V

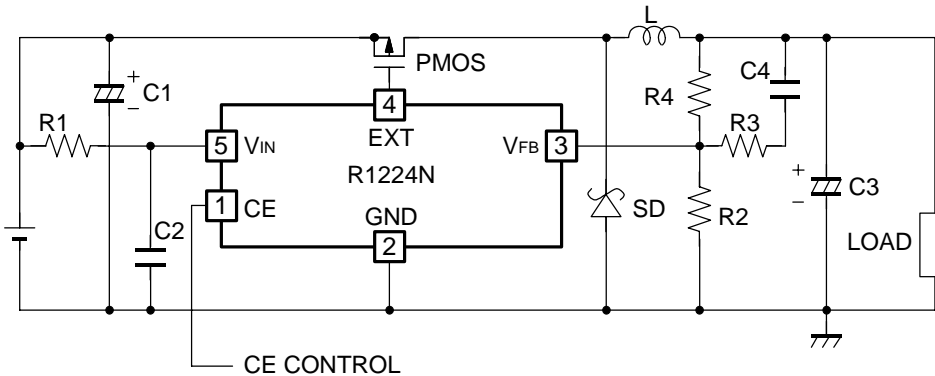

PMOS: HAT1044M (Hitachi) L : CR105-270MC (Sumida, 27 μ H)
 SD1 : RB063L-30 (Rohm) C3 : 47 μ F (Tantalum Type)
 C1 : 10 μ F (Ceramic Type) C2 : 0.1 μ F (Ceramic Type) C4: 1000pF (Ceramic Type)
 R1 : 10 Ω , R2=22k Ω , R3=2.7k Ω , R4=33k Ω

R1224N

When you use these ICs, consider the following issues;

·As shown in the block diagram, a parasitic diode is formed in each terminal, each of these diodes is not formed for load current, therefore do not use it in such a way. When you control the CE pin by another power supply, do not make its "H" level more than the voltage level of V_{IN} pin.

·Set external components as close as possible to the IC and minimize the connection between the components and the IC. In particular, a capacitor should be connected to V_{OUT} pin with the minimum connection. Make sufficient ground and reinforce supplying. A large switching current could flow through the connection of power supply, an inductor and the connection of V_{OUT} . If the impedance of the connection of power supply is high, the voltage level of power supply of the IC fluctuates with the switching current. This may cause unstable operation of the IC.

·Protection circuit may work if the maximum duty cycle continue for the time defined in the electrical characteristics. Once after stopping the output voltage, output will restart with soft-start operation. If the difference between input voltage and output voltage is small, the protection circuit may work.

·Use capacitors with a capacity of 22 μ F or more for V_{OUT} pin, and with good high frequency characteristics such as tantalum capacitors. We recommend you to use output capacitors with an allowable voltage at least twice as much as setting output voltage. This is because there may be a case where a spike-shaped high voltage is generated by an inductor when an external transistor is on and off.

·Choose an inductor that has sufficiently small D.C. resistance and large allowable current and is hard to reach magnetic saturation. And if the value of inductance of an inductor is extremely small, the I_{LX} may exceed the absolute maximum rating at the maximum loading.
Use an inductor with appropriate inductance.

·Use a diode of a Schottky type with high switching speed, and also pay attention to its current capacity.

·Do not use this IC under the condition with V_{IN} voltage at equal or less than minimum operating voltage.

·When the threshold level of an external power MOSFET is rather low and the drive-ability of voltage supplier is small, if the output pin is short circuit, input voltage may be equal or less than UVLO detector threshold. In this case, the device is reset with UVLO function that is different from the reset-protection function caused by maximum duty cycle.

·With the PWM/VFM alternative circuit, when the on duty cycle of switching is 35% or less, the R1224N alters from PWM mode to VFM mode (Pulse skip mode). The purpose of this circuit is raising the efficiency with a light load by skipping the frequency and suppressing the consumption current. However, the ratio of output voltage against input voltage is 35% or less, (ex. $V_{IN}>8.6V$ and $V_{OUT}=3.0V$) even if the large current may be loaded, the IC keeps its VFM mode. As a result, frequency might be decreased, and oscillation waveform might be unstable. These phenomena are the typical characteristics of the IC with PWM/VFM alternative circuit.

★The performance of power source circuits using these ICs extremely depends upon the peripheral circuits. Pay attention in the selection of the peripheral circuits. In particular, design the peripheral circuits in a way that the values such as voltage, current, and power of each component, PCB patterns and the IC do not exceed their respected rated values.

How to Adjust Output Voltage and about Phase Compensation

As for Adjustable Output type, feedback pin (V_{FB}) voltage is controlled to maintain 1.0V.
Output Voltage, V_{OUT} is as following equation:

$$V_{OUT}: R2+R4=V_{FB}: R2$$

$$V_{OUT}=V_{FB}\times(R2+R4)/R2$$

Thus, with changing the value of R2 and R4, output voltage can be set in the specified range.
In the DC/DC converter, with the load current and external components such as L and C, phase might be behind 180 degree. In this case, the phase margin of the system will be less and stability will be worse. To prevent this, phase margin should be secured with proceeding the phase. A pole is formed with external components L and C3.

$$F_{pole} \sim 1/2\pi\sqrt{L \times C3}$$

A zero (signal back to zero) is formed with R4 and C4.

$$\cong F_{zero} \sim 1/(2\pi \times R4 \times C4)$$

For example, if $L=27\mu\text{H}$, $C3=47\mu\text{F}$, the cut off frequency of the pole is approximately 4.5kHz.
To make the cut off frequency of the pole as much as 4.5kHz, set $R4=33\text{k}\Omega$ and $C4=1000\text{pF}$.
If V_{OUT} is set at 2.5V, $R2=22\text{k}\Omega$ is appropriate.
 $R3$ prevents feedback of the noise to V_{FB} pin, about 2.7k Ω is appropriate value.

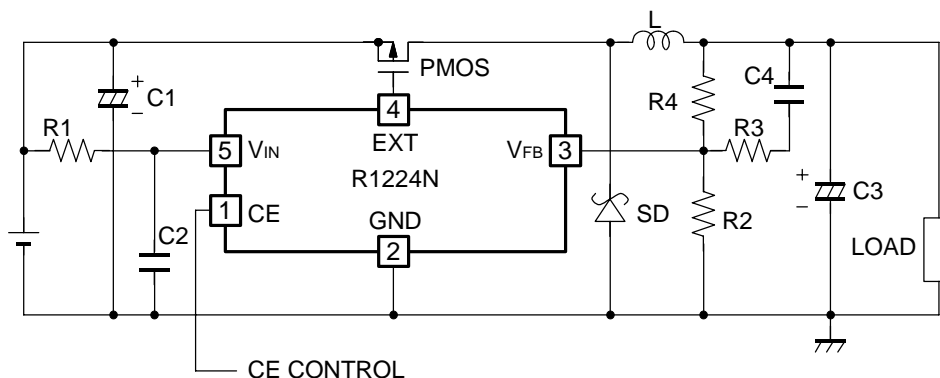

OPERATION of step-down DC/DC converter and Output Current

The step-down DC/DC converter charges energy in the inductor when Lx transistor is ON, and discharges the energy from the inductor when Lx transistor is OFF and controls with less energy loss, so that a lower output voltage than the input voltage is obtained. The operation will be explained with reference to the following diagrams:

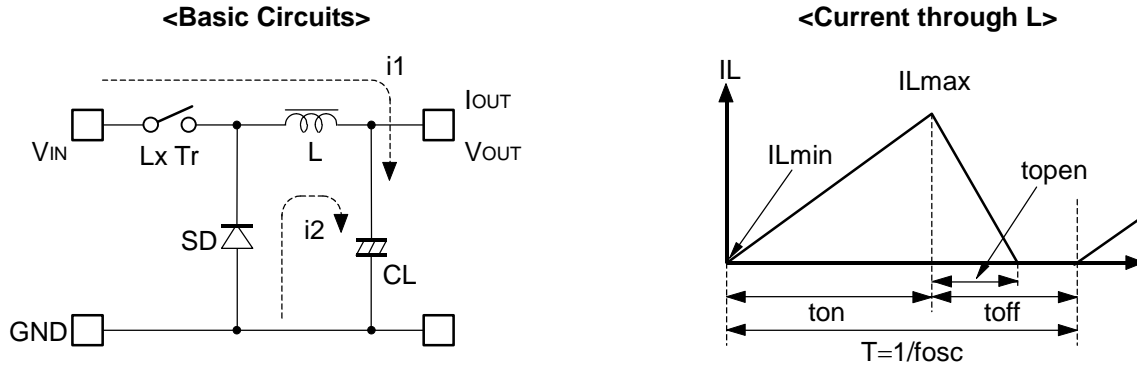

- Step 1: Lx Tr. turns on and current IL (=i1) flows, and energy is charged into CL. At this moment, IL increases from ILmin. (=0) to reach ILmax. in proportion to the on-time period (ton) of Lx Tr.
- Step 2: When Lx Tr. turns off, Schottky diode (SD) turns on in order that L maintains IL at ILmax, and current IL (=i2) flows.
- Step 3: IL decreases gradually and reaches ILmin. after a time period of toff, and SD turns off, provided that in the continuous mode, next cycle starts before IL becomes to 0 because toff time is not enough. In this case, IL value is from this ILmin (>0).

In the case of PWM control system, the output voltage is maintained by controlling the on-time period (ton), with the oscillator frequency (fosc) being maintained constant.

Discontinuous Conduction Mode and Continuous Conduction Mode

The maximum value (ILmax) and the minimum value (ILmin) current which flow through the inductor is the same as those when Lx Tr. is ON and when it is OFF.

The difference between ILmax and ILmin, which is represented by ΔI;

$$\Delta I = I_{Lmax} - I_{Lmin} = V_{OUT} \times t_{open} / L = (V_{IN} - V_{OUT}) \times t_{on} / L \dots\dots\dots \text{Equation 1}$$

wherein, $T = 1/f_{osc} = t_{on} + t_{off}$
 duty (%) = $t_{on} / T \times 100 = t_{on} \times f_{osc} \times 100$
 $t_{open} \leq t_{off}$

In Equation 1, $V_{OUT} \times t_{open} / L$ and $(V_{IN} - V_{OUT}) \times t_{on} / L$ are respectively shown the change of the current at ON, and the change of the current at OFF.

When the output current (IOUT) is relatively small, $t_{open} < t_{off}$ as illustrated in the above diagram. In this case, the energy is charged in the inductor during the time period of ton and is discharged in its entirely during the time period of toff, therefore ILmin becomes to zero (ILmin=0). When Iout is gradually increased, eventually, t_{open} becomes to toff ($t_{open} = t_{off}$), and when IOUT is further increased, ILmin becomes larger than zero (ILmin>0). The former mode is referred to as the discontinuous mode and the latter mode is referred to as continuous mode.

In the continuous mode, when Equation 1 is solved for t_{on} and assumed that the solution is t_{onc} ,

$$t_{onc} = T \times V_{OUT} / V_{IN} \dots \dots \dots \text{Equation 2}$$

When $t_{on} < t_{onc}$, the mode is the discontinuous mode, and when $t_{on} = t_{onc}$, the mode is the continuous mode.

OUTPUT CURRENT AND SELECTION OF EXTERNAL COMPONENTS

When Lx Tr. is ON:

(Wherein, Ripple Current P-P value is described as I_{RP} , ON resistance of Lx Tr. is described as R_p the direct current of the inductor is described as R_L .)

$$V_{IN} = V_{OUT} + (R_p + R_L) \times I_{OUT} + L \times I_{RP} / t_{on} \dots \dots \dots \text{Equation 3}$$

When Lx Tr. is OFF:

$$L \times I_{RP} / t_{off} = V_F + V_{OUT} + R_L \times I_{OUT} \dots \dots \dots \text{Equation 4}$$

Put Equation 4 to Equation 3 and solve for ON duty, $t_{on} / (t_{off} + t_{on}) = D_{ON}$,

$$D_{ON} = (V_{OUT} + V_F + R_L \times I_{OUT}) / (V_{IN} + V_F - R_p \times I_{OUT}) \dots \dots \dots \text{Equation 5}$$

Ripple Current is as follows;

$$I_{RP} = (V_{IN} - V_{OUT} - R_p \times I_{OUT} - R_L \times I_{OUT}) \times D_{ON} / f / L \dots \dots \dots \text{Equation 6}$$

Wherein, peak current that flows through L, Lx Tr., and SD is as follows;

$$I_{Lmax} = I_{OUT} + I_{RP} / 2 \dots \dots \dots \text{Equation 7}$$

Consider I_{Lmax} , condition of input and output and select external components.

★ The above explanation is directed to the calculation in an ideal case in continuous mode.

External Components

1. Inductor

Select an inductor that peak current does not exceed I_{Lmax} . If larger current than allowable current flows, magnetic saturation occurs and make transform efficiency worse.

When the load current is definite, the smaller value of L , the larger the ripple current.

Provided that the allowable current is large in that case and DC current is small, therefore, for large output current, efficiency is better than using an inductor with a large value of L and vice versa.

2. Diode

Use a diode with low V_F (Schottky type is recommended.) and high switching speed.

Reverse voltage rating should be more than V_{IN} and current rating should be equal or more than I_{Lmax} .

3. Capacitors

As for C_{IN} , use a capacitor with low ESR (Equivalent Series Resistance) and a capacity of at least $10\mu F$ for stable operation.

C_{OUT} can reduce ripple of Output Voltage, therefore $47\mu F$ or more value of tantalum type capacitor is recommended.

4. Lx Transistor

Pch Power MOSFET is required for this IC.

Its breakdown voltage between gate and source should be a few V higher than Input Voltage.

In the case of Input Voltage is low, to turn on MOSFET completely, to use a MOSFET with low threshold voltage is effective.

If a large load current is necessary for your application and important, choose a MOSFET with low ON resistance for good efficiency.

If a small load current is mainly necessary for your application, choose a MOSFET with low gate capacity for good efficiency.

Maximum continuous drain current of MOSFET should be larger than peak current, I_{Lmax} .

TIMING CHART

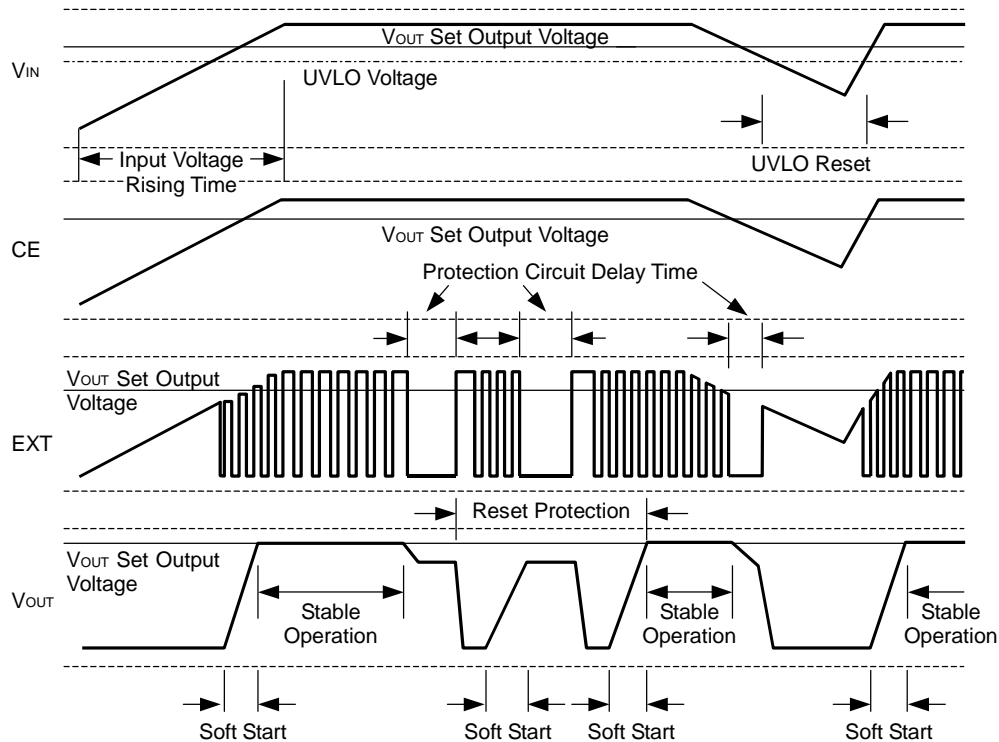

The timing chart shown above describes the changing process of input voltage rising, stable operating, operating with large current, stable operating, input voltage falling, input voltage recovering, and stable operating.

First, until when the input voltage (V_{IN}) reaches UVLO voltage, the circuit inside keeps the condition of pre-standby.

Second, after V_{IN} becomes beyond the UVLO threshold, soft-start operation starts, when the soft-start operation finishes, the operation becomes stable.

If too large current flows through the circuit because of short or other reasons, EXT signal ignores that during the delay time of protection circuit. (The current value depends on the circuit.)

After the delay time passes, reset protection works, or EXT signal will be "H", then output will turn off, then soft-start operation starts. After the soft-start operation, EXT signal will be "L", but if the large current is still flowing, after the delay time of protection circuit passes, reset protection circuit will work again, the operation will be continuously repeated unless the cause of large current flowing is not removed.

Once the cause of the large current flowing is removed, within the delay time, the operation will be back to the stable one.

If the timing for release the large current is in the protection process, the operation will be back to the normal one after the soft-start operation.

If the V_{IN} becomes lower than the set V_{OUT} , that situation is same as large current condition, so protection circuit may be ready to work, therefore, after the delay time of protection circuit, EXT will be "H".

Further, if the V_{IN} is lower than UVLO voltage, the circuit inside will be stopped by UVLO function.

After that, if V_{IN} rises, until when the V_{IN} reaches UVLO voltage, the circuit inside keeps the condition of pre-standby.

Then after V_{IN} becomes beyond the UVLO threshold, soft-start operation starts, when the soft-start operation finishes, the operation becomes stable.

TEST CIRCUITS

Output Voltage, Oscillator Frequency, CE "H" Input Voltage, CE "L" Input Voltage, Soft-start time

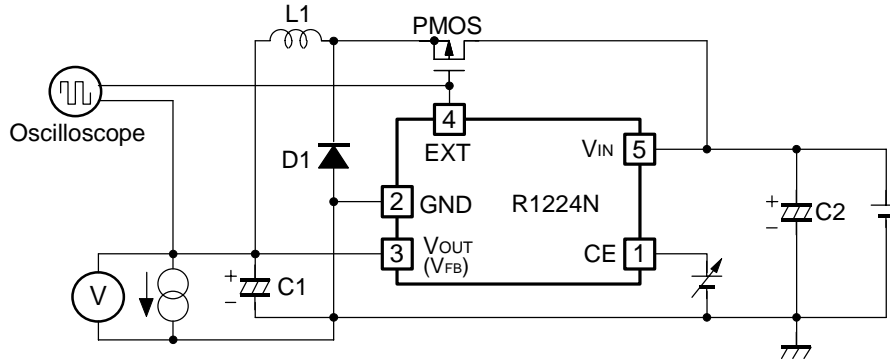

Supply Current 1

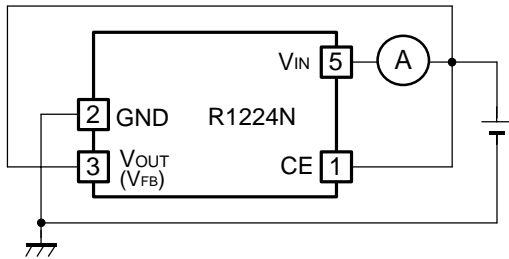

Standby Current

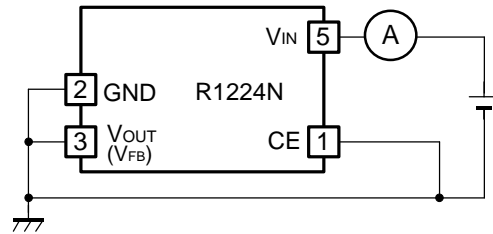

EXT "H" Output Current

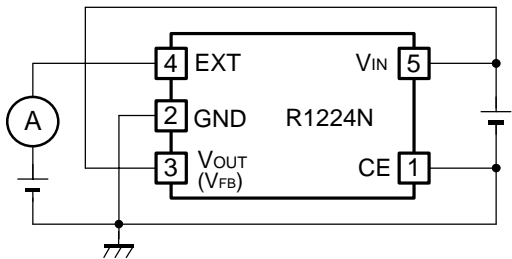

EXT "L" Output Current

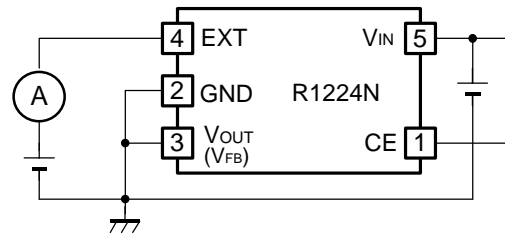

CE "H" Input Current, CE "L" Input Current

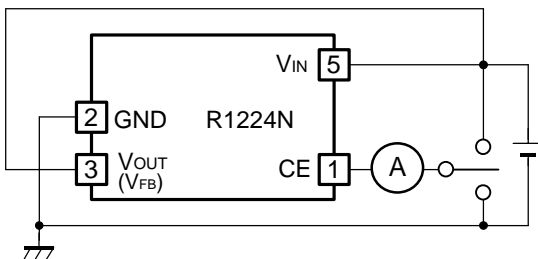

Output Delay Time for Protection Circuit

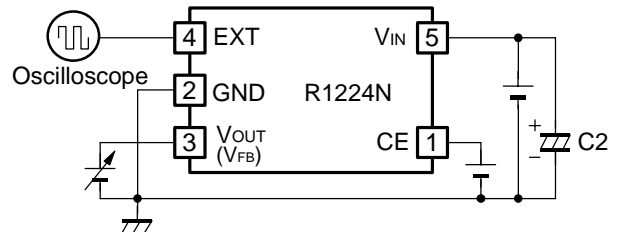

PMOS: HAT1044M (Hitachi)
SD1 : RB491D (Rohm)
C1 : 47 μ F (Tantalum Type)

L : CD104-270MC (Sumida, 27 μ H)
C2: 47 μ F (Tantalum Type)

TYPICAL CHARACTERISTICS

1) Output Voltage vs. Output Current (*Note)

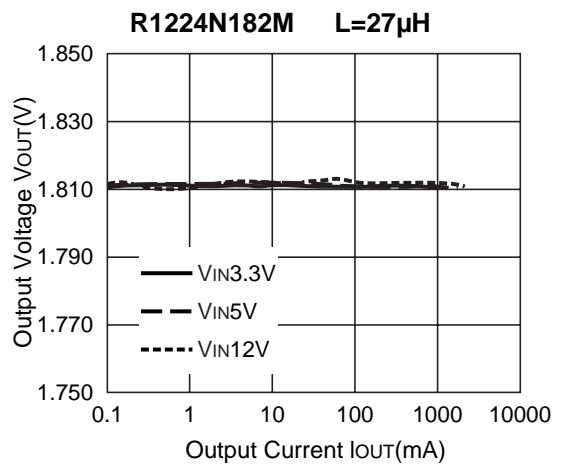
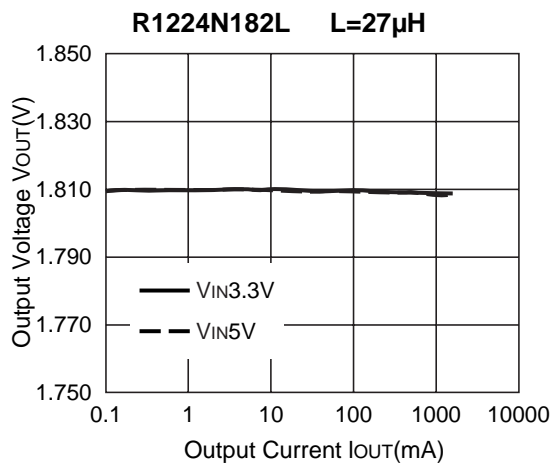
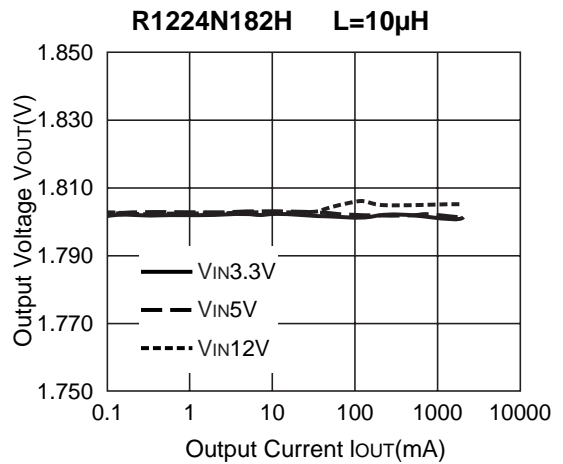
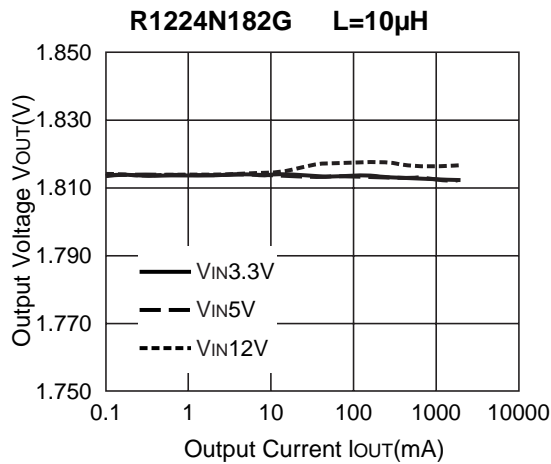
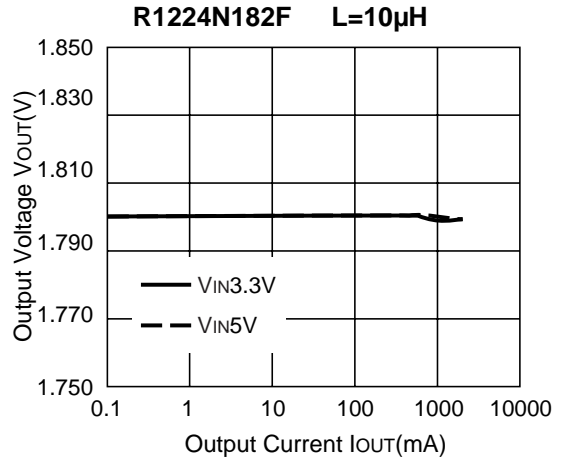
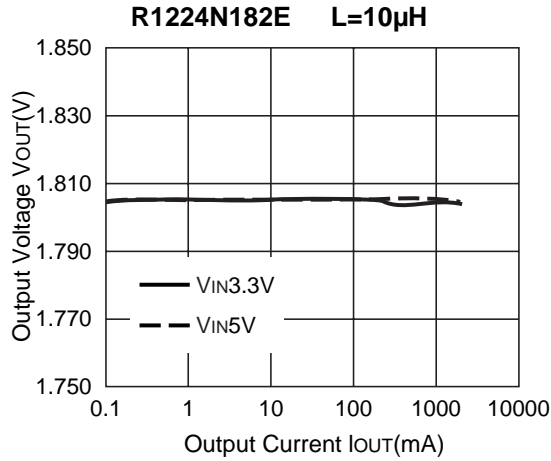

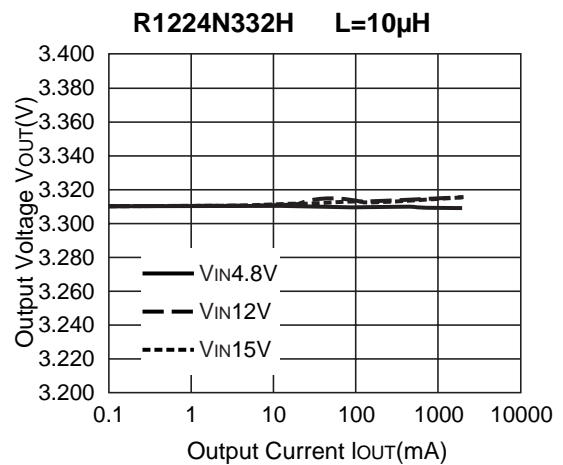
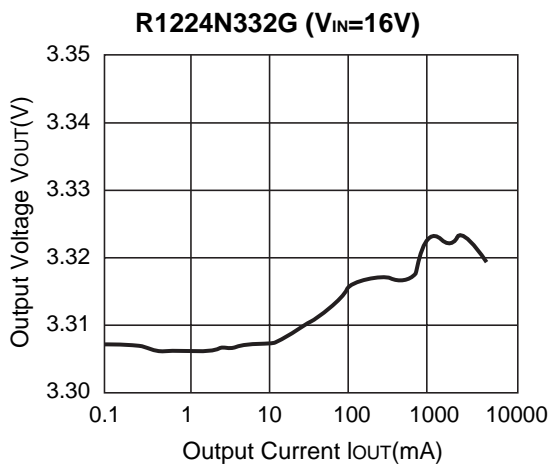
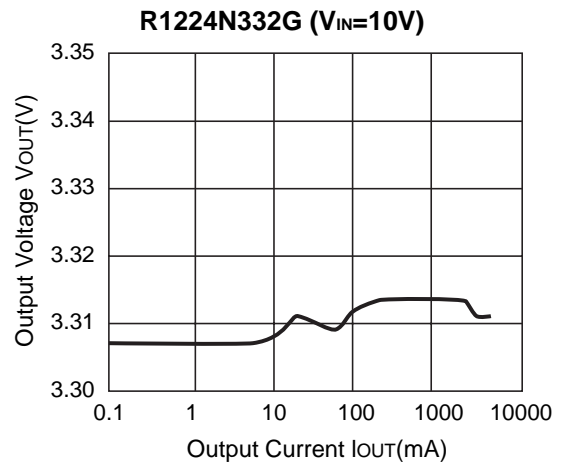
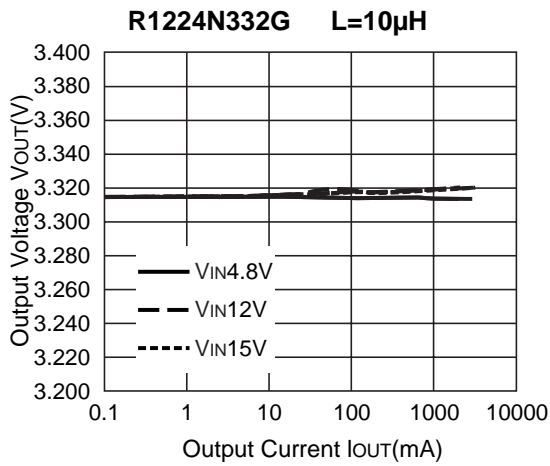
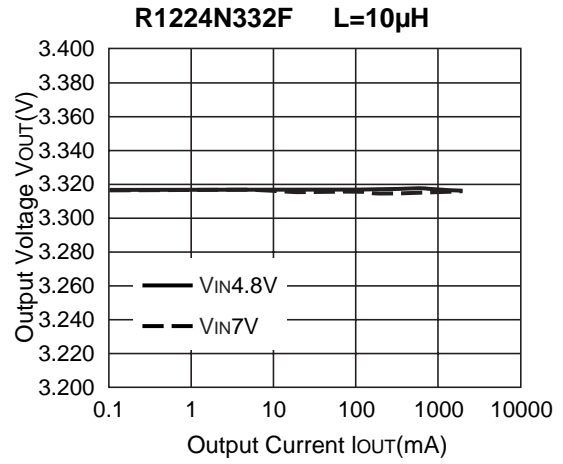
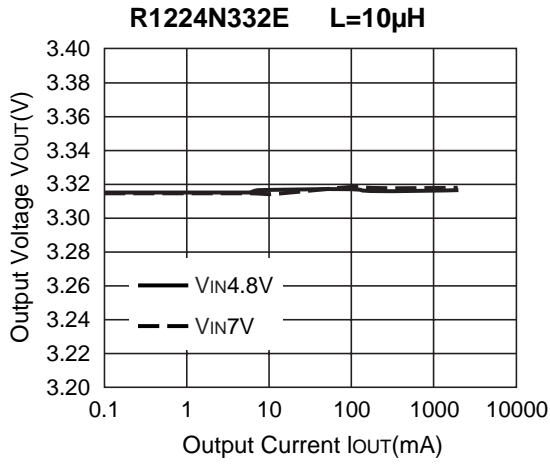

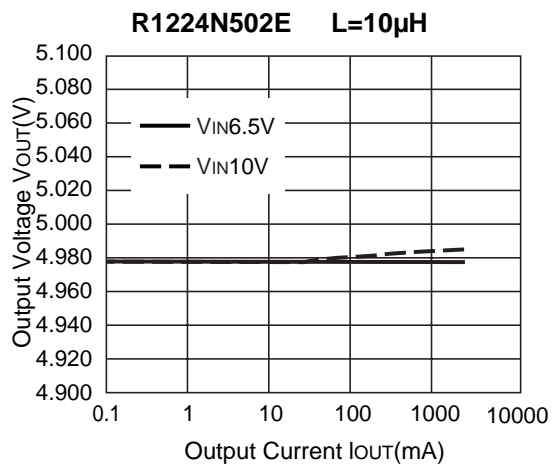
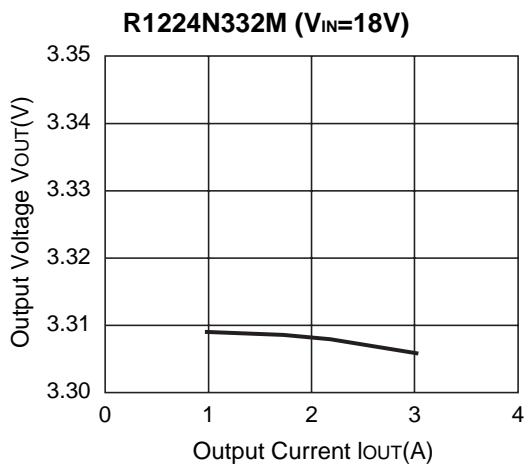
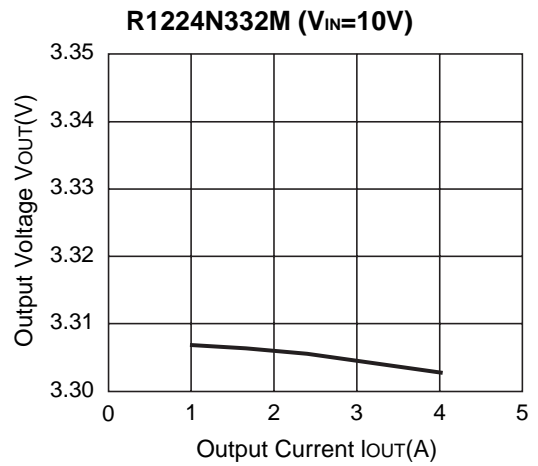
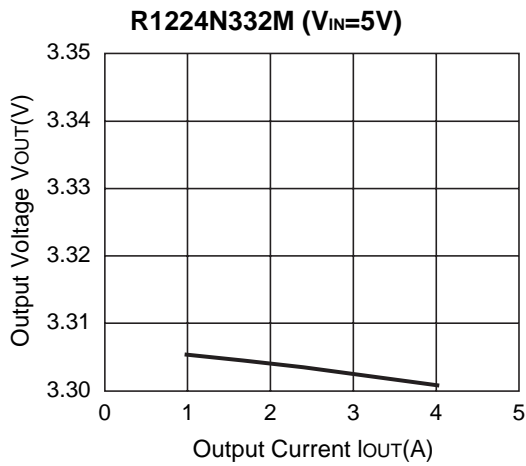
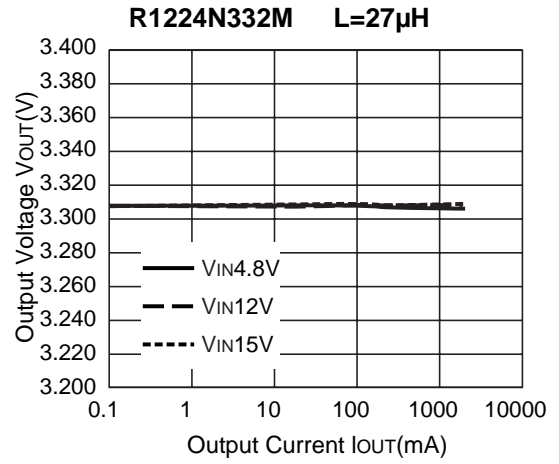
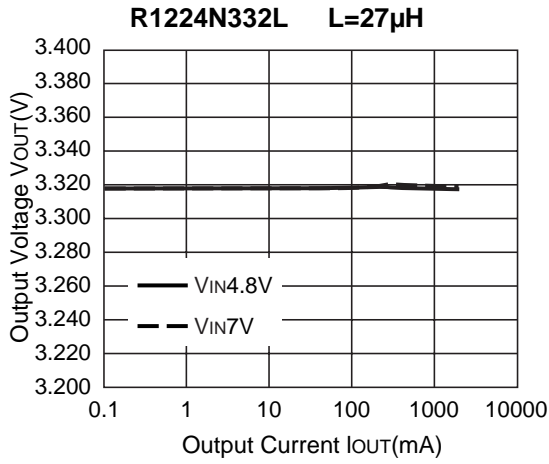

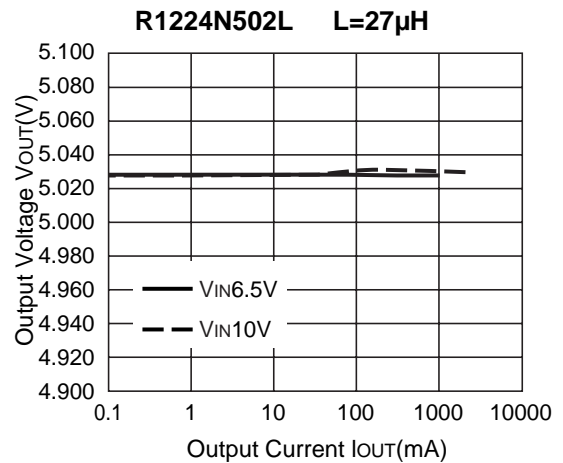
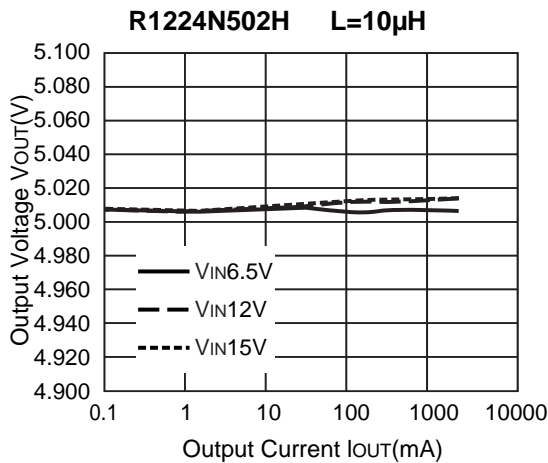
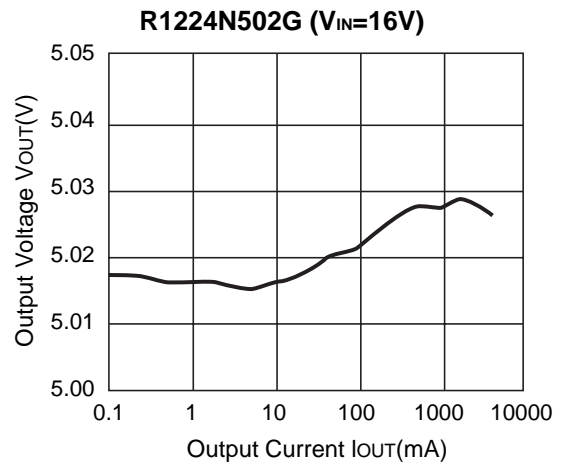
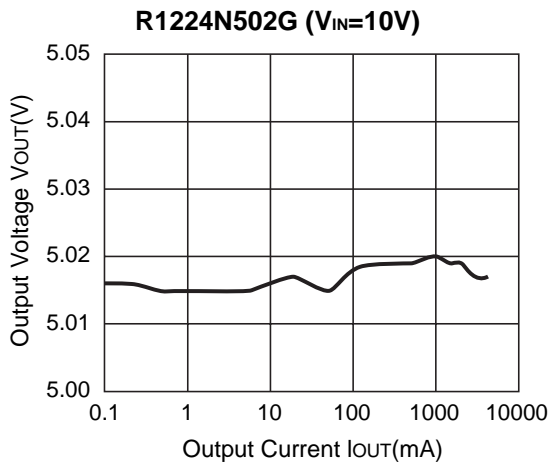
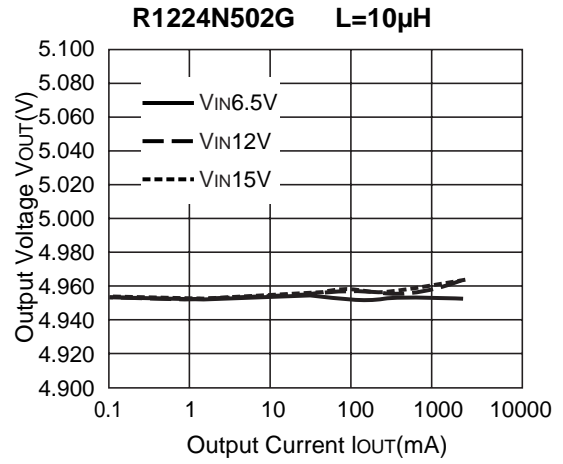
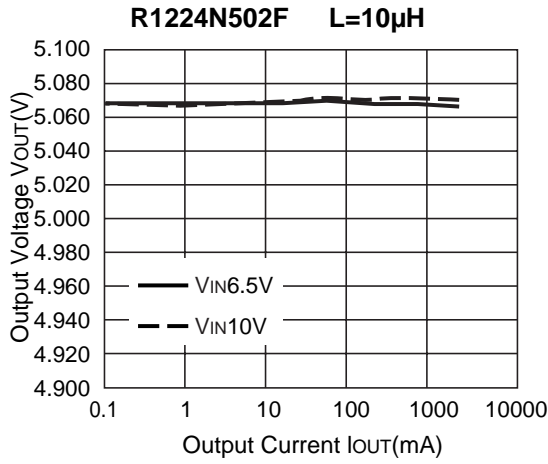

R1224N502M L=27μH

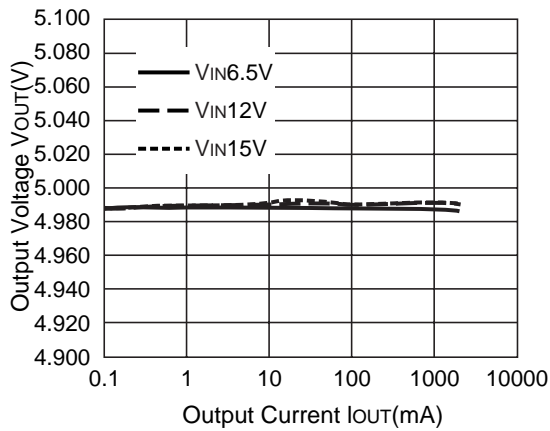

*Note: Typical characteristics 1) are obtained with using the following components;
 PMOS: IRF7406 (IR)
 L : CDRH127-100MC (Sumida: 10μH)
 SD : RB083L-20 (Rohm)
 C1 : 25SC47 (Sanyo/OS-con: 47μF/25V)×2
 C2 : 0.1μF (Ceramic Type)
 C3 : 10SA220 (Sanyo/OS-con: 220μF/10V)
 R1 : 10Ω

2) Efficiency vs. Output Current (*Note)

R1224N182F (VIN=3.3V) CDRH127-10μH

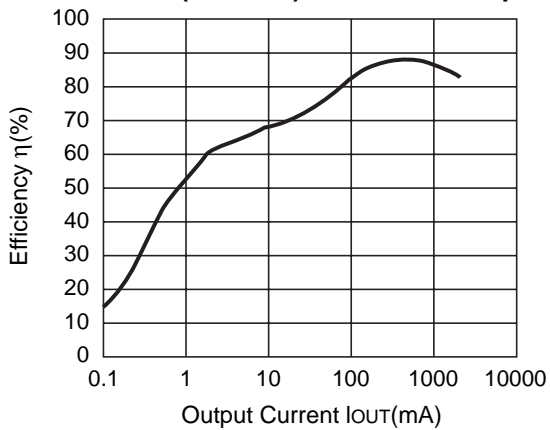

R1224N182F (VIN=5.0V) CDRH127-10μH

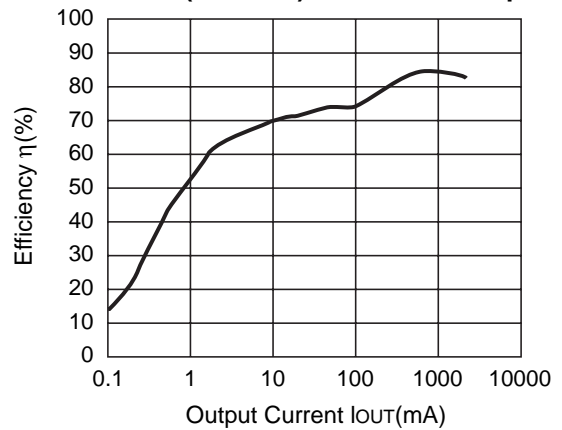

R1224N182G (VIN=3.3V) CDRH127-10μH

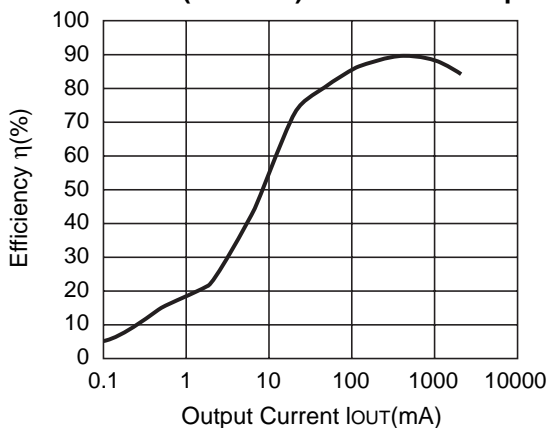

R1224N182G (VIN=5.0V) CDRH127-10μH

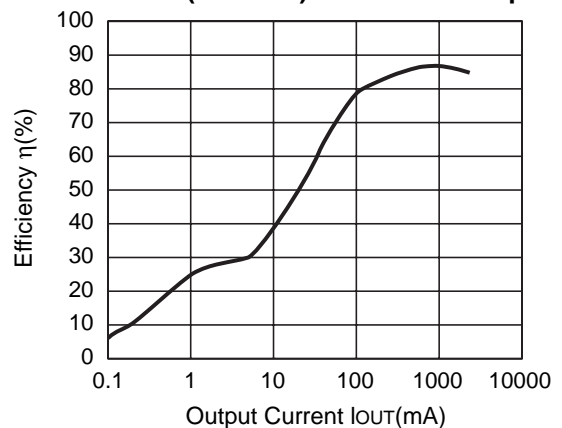

R1224N182G (V_{IN}=12V) CDRH127-10μH

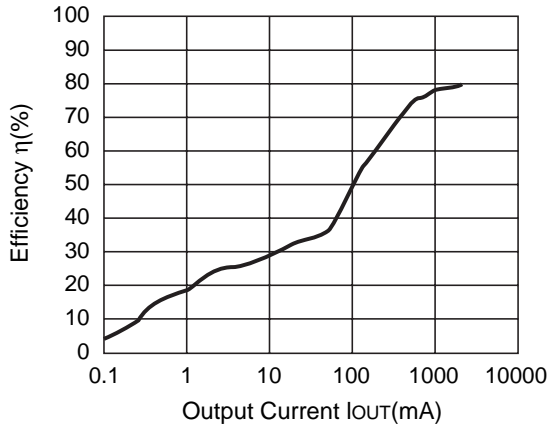

R1224N182H (V_{IN}=3.3V) CDRH127-10μH

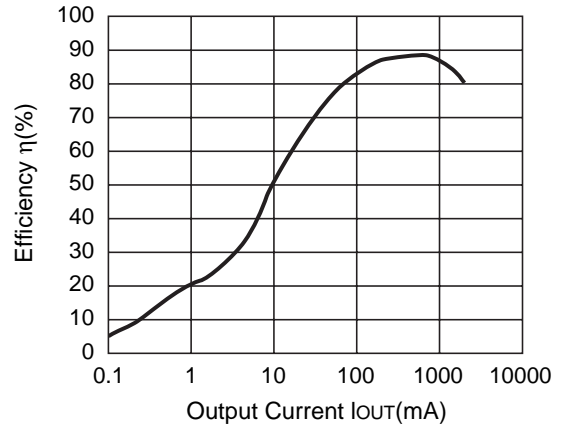

R1224N182H (V_{IN}=5.0V) CDRH127-10μH

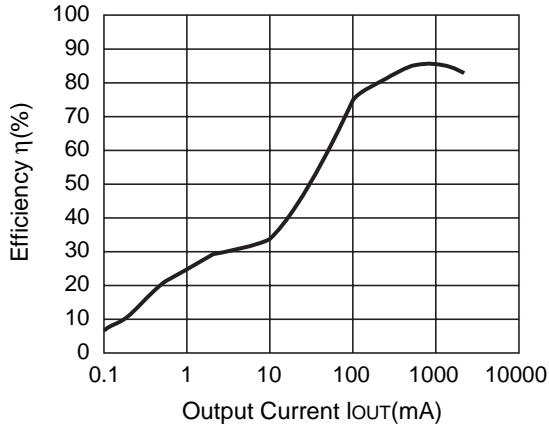

R1224N182H (V_{IN}=12V) CDRH127-10μH

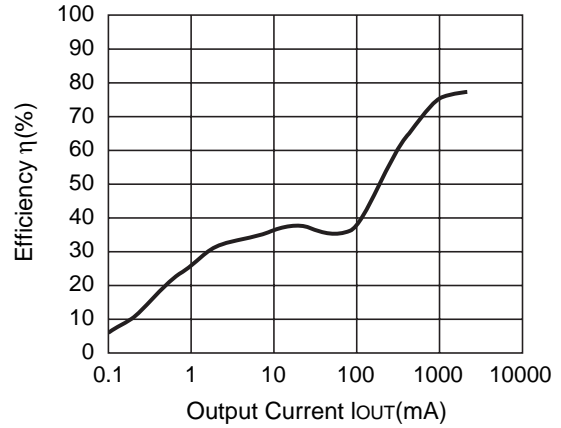

R1224N182L (V_{IN}=3.3V) CDRH127-27μH

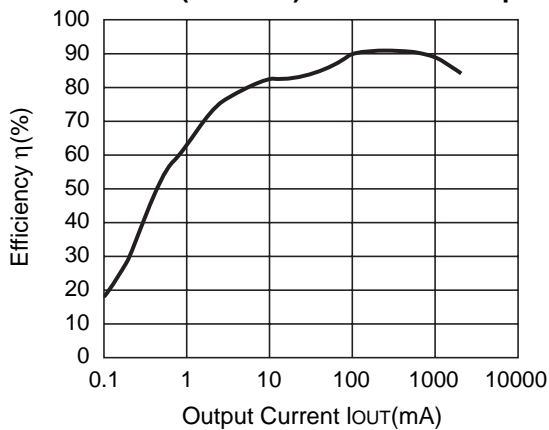

R1224N182L (V_{IN}=5.0V) CDRH127-27μH

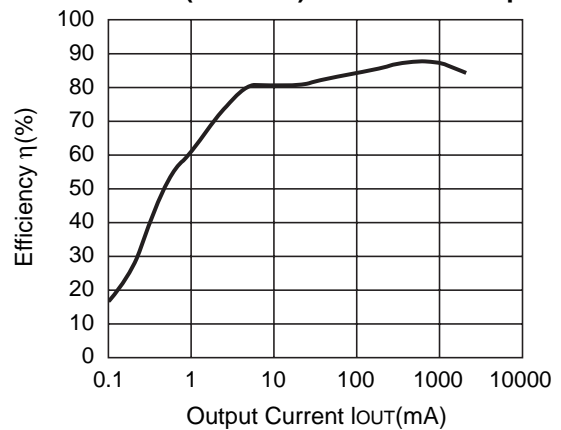

R1224N182M (V_{IN}=3.3V) CDRH127-27μH

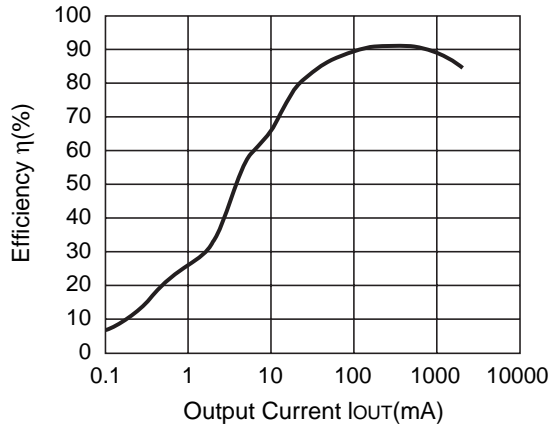

R1224N182M (V_{IN}=5.0V) CDRH127-27μH

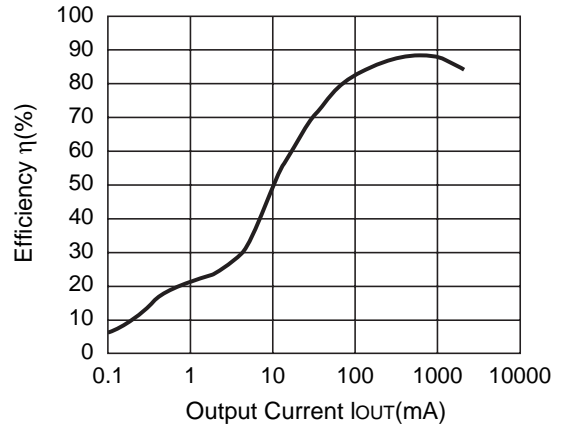

R1224N182M (V_{IN}=12V) CDRH127-27μH

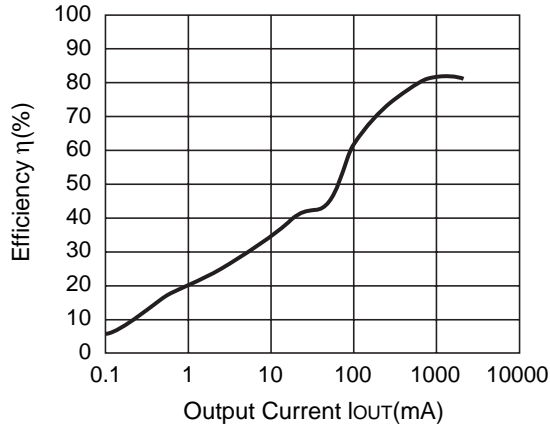

R1224N332E (V_{IN}=7.0V) CDRH127-10μH

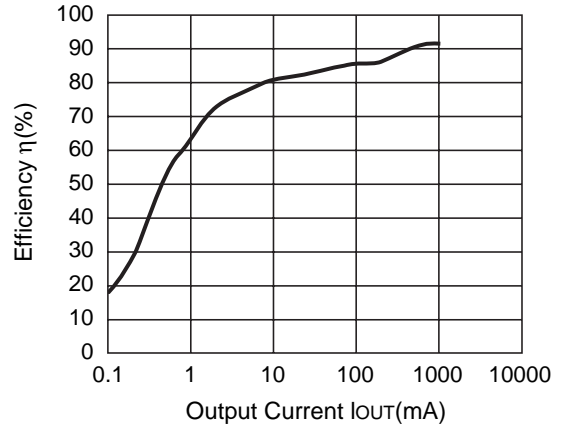

R1224N332E (V_{IN}=4.8V) CDRH127-10μH

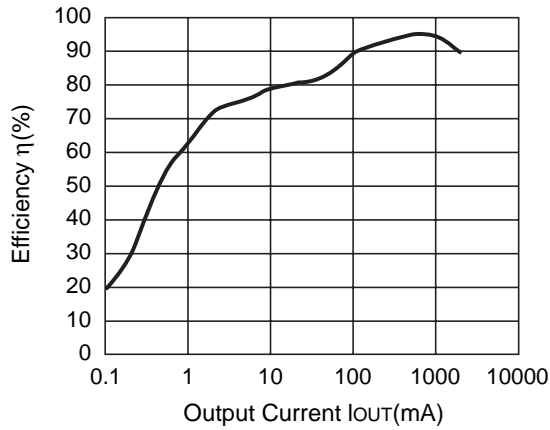

R1224N332F (V_{IN}=7.0V) CDRH127-10μH

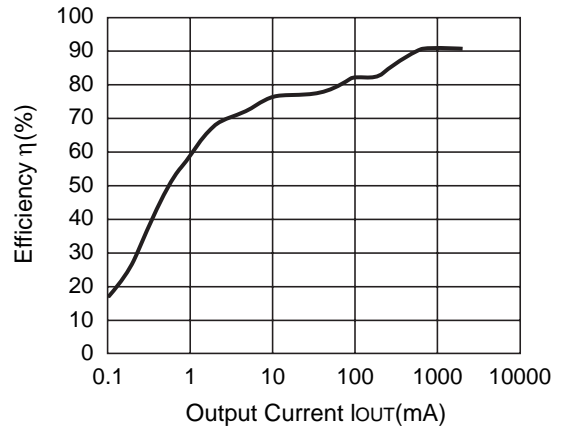

R1224N332F (V_{IN}=4.8V) CDRH127-10μH

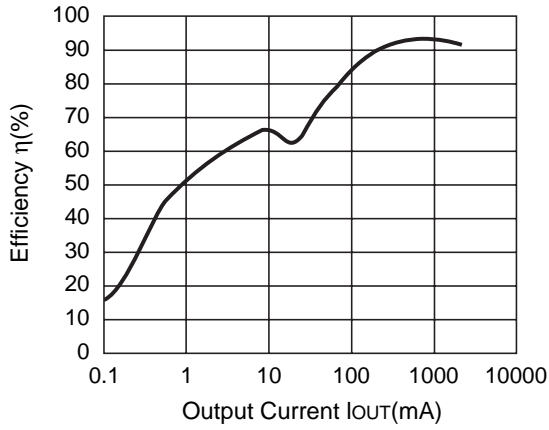

R1224N332G (V_{IN}=12V) CDRH127-10μH

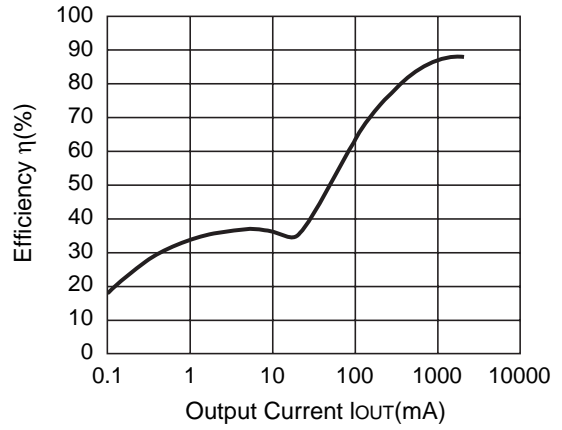

R1224N332G (V_{IN}=4.8V) CDRH127-10μH

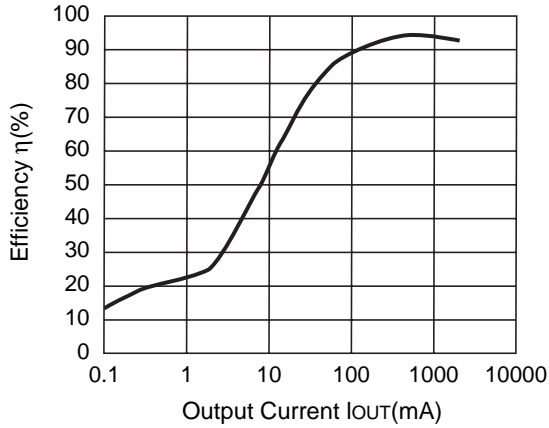

R1224N332G (V_{IN}=10V)

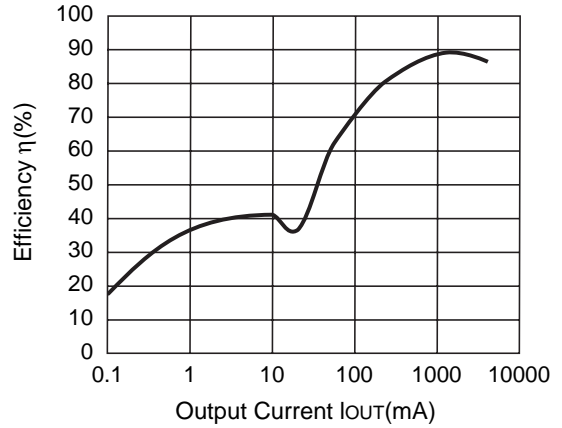

R1224N332G (V_{IN}=16V)

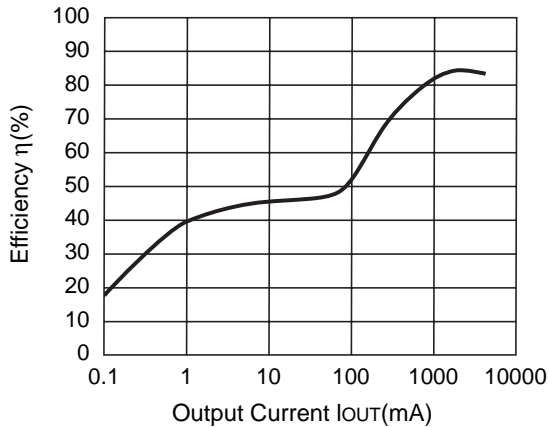

R1224N332G (V_{IN}=15V) CDRH127-10μH

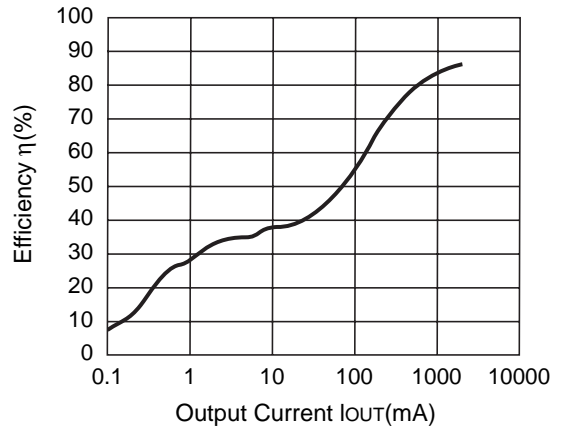

R1224N332H (V_{IN}=12V) CDRH127-10μH

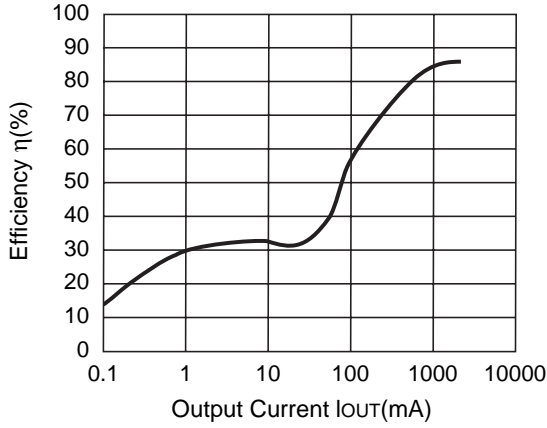

R1224N332H (V_{IN}=4.8V) CDRH127-10μH

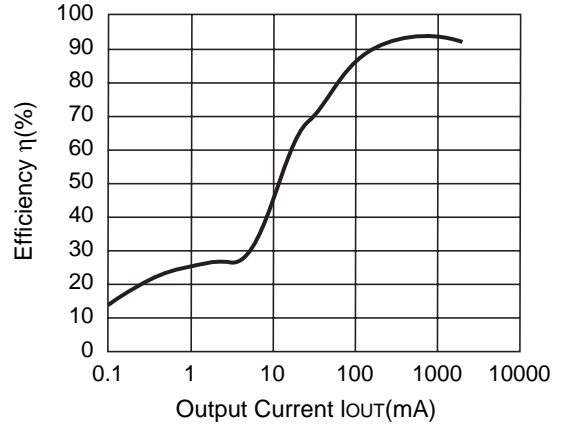

R1224N332H (V_{IN}=15V) CDRH127-10μH

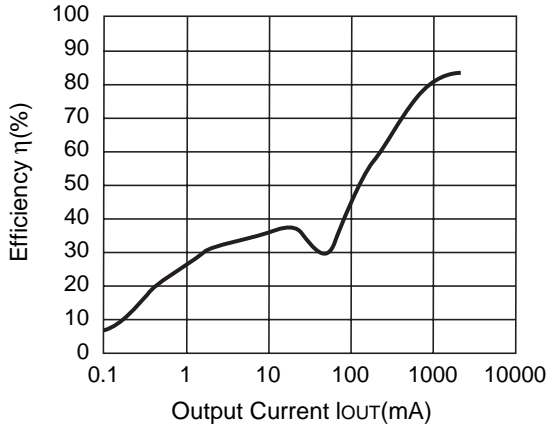

R1224N332L (V_{IN}=7.0V) CDRH127-27μH

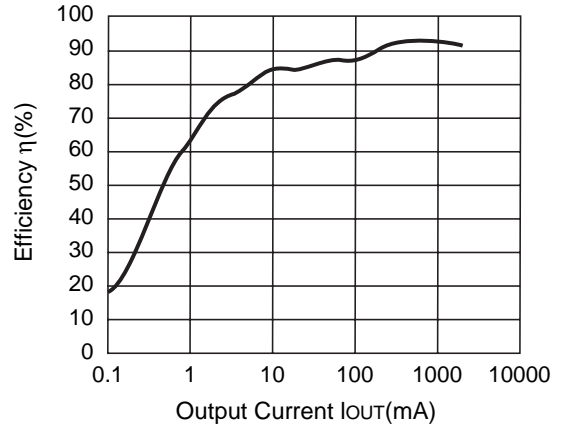

R1224N332L (V_{IN}=4.8V) CDRH127-27μH

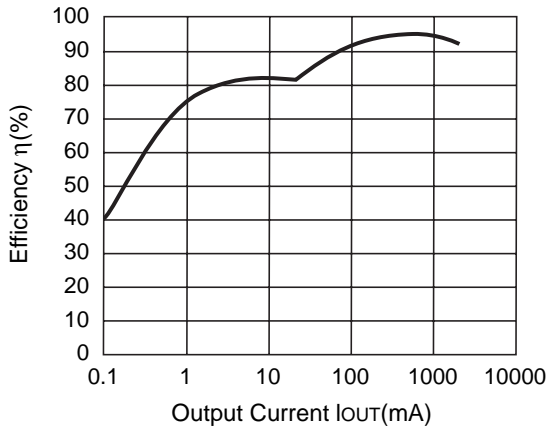

R1224N332M (V_{IN}=12V) CDRH127-27μH

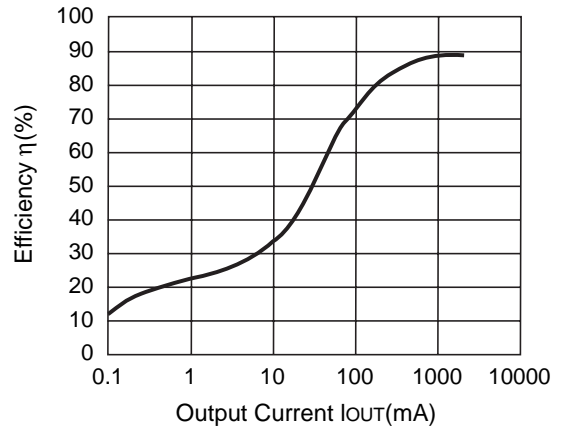

R1224N332M (V_{IN}=4.8V) CDRH127-27μH

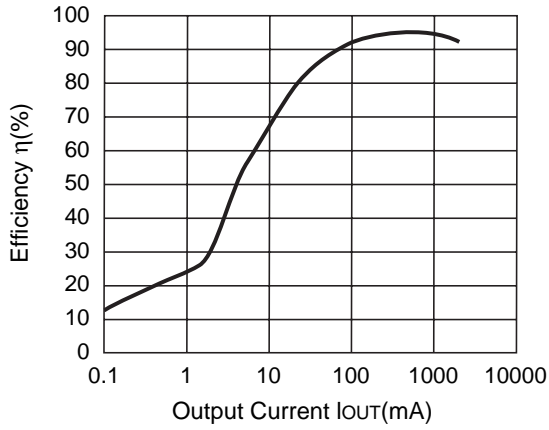

R1224N332M (V_{IN}=5V)

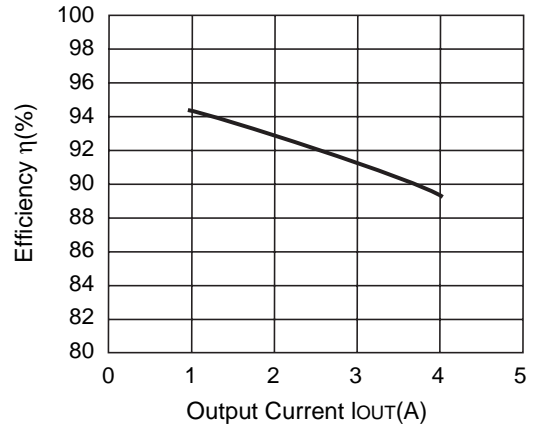

R1224N332M (V_{IN}=10V)

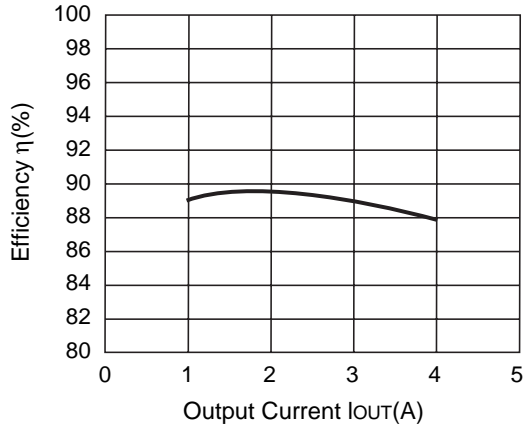

R1224N332M (V_{IN}=18V)

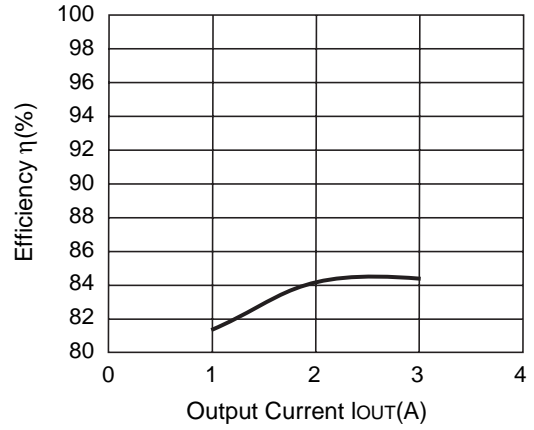

R1224N332M (V_{IN}=15V) CDRH127-27μH

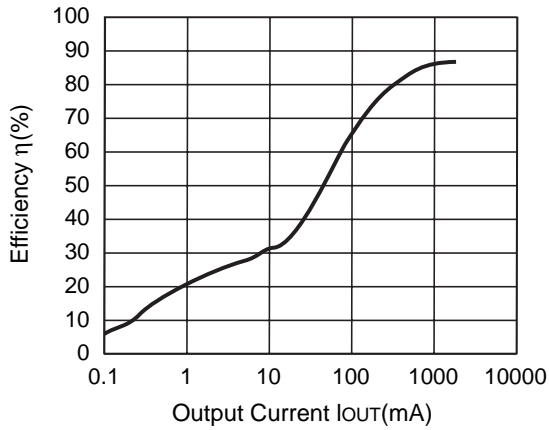

R1224N502E (V_{IN}=6.5V) CDRH127-10μH

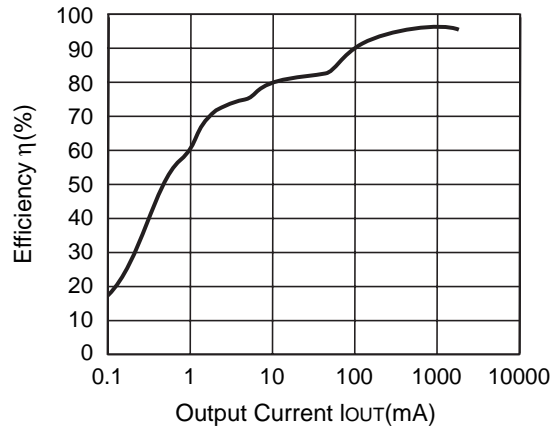

R1224N502E (V_{IN}=10V) CDRH127-10μH

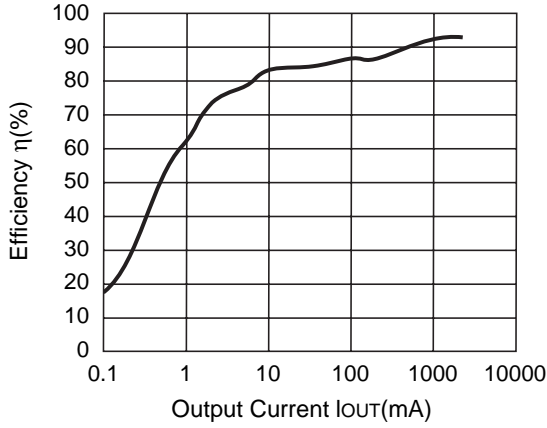

R1224N502F (V_{IN}=6.5V) CDRH127-10μH

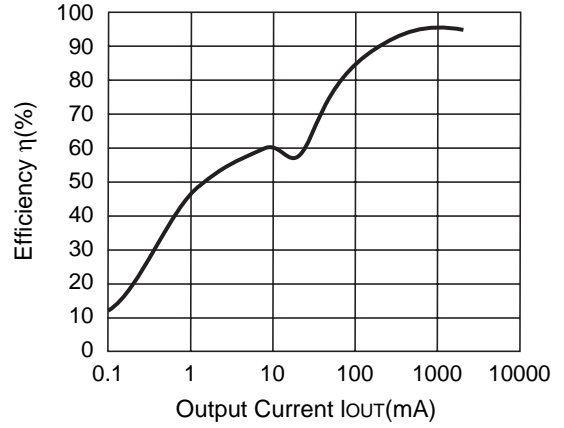

R1224N502F (V_{IN}=10V) CDRH127-10μH

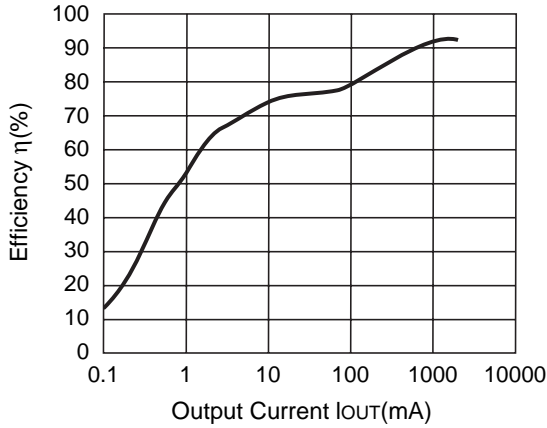

R1224N502G (V_{IN}=10V)

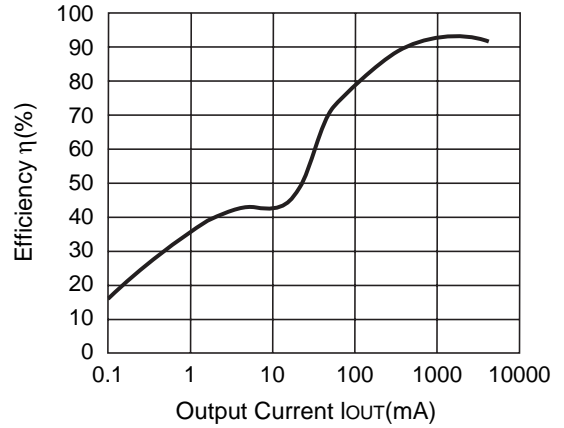

R1224N502G (V_{IN}=16V)

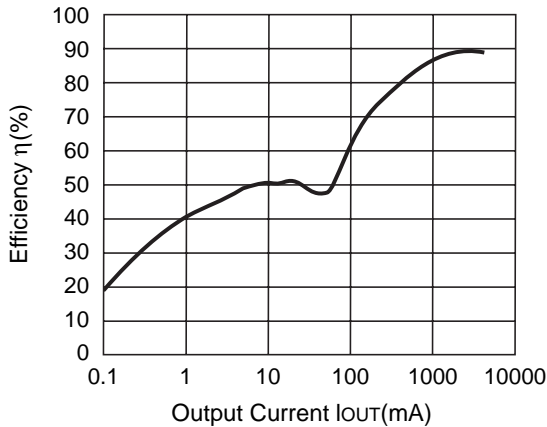

R1224N502G (V_{IN}=6.5V) CDRH127-10μH

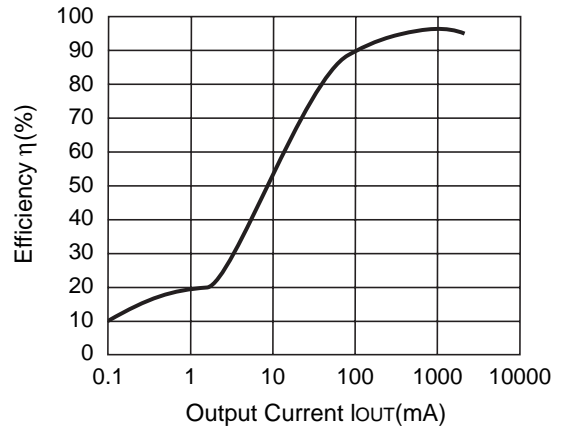

R1224N502G (V_{IN}=12V) CDRH127-10μH

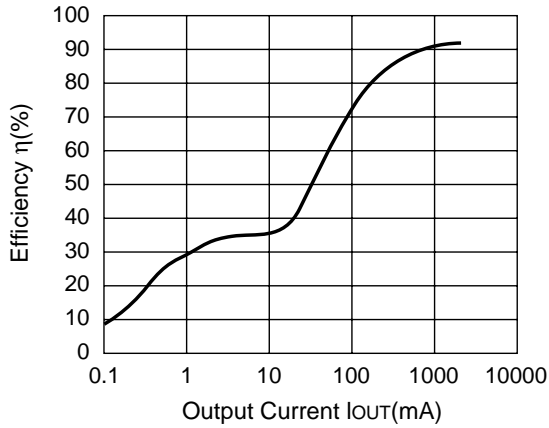

R1224N502G (V_{IN}=15V) CDRH127-10μH

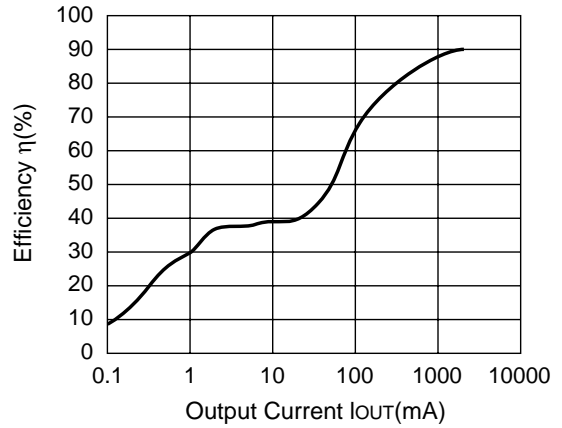

R1224N502H (V_{IN}=6.5V) CDRH127-10μH

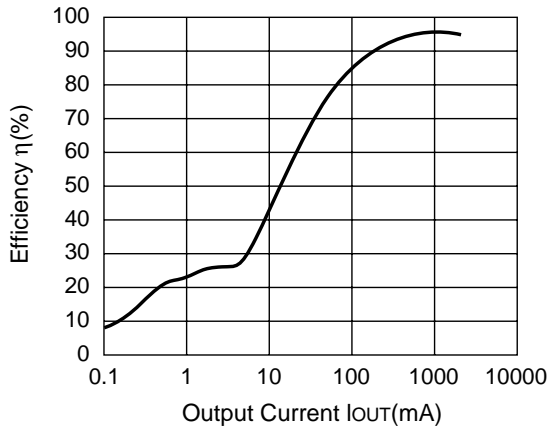

R1224N502H (V_{IN}=12V) CDRH127-10μH

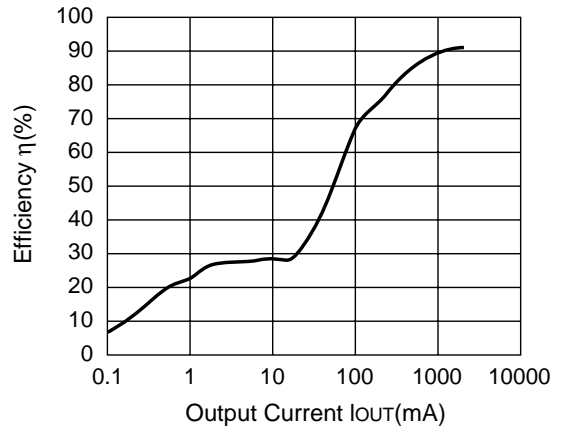

R1224N502H (V_{IN}=15V) CDRH127-10μH

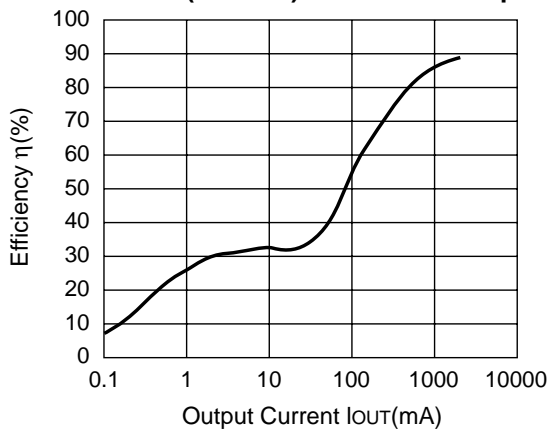

R1224N502L (V_{IN}=6.5V) CDRH127-27μH

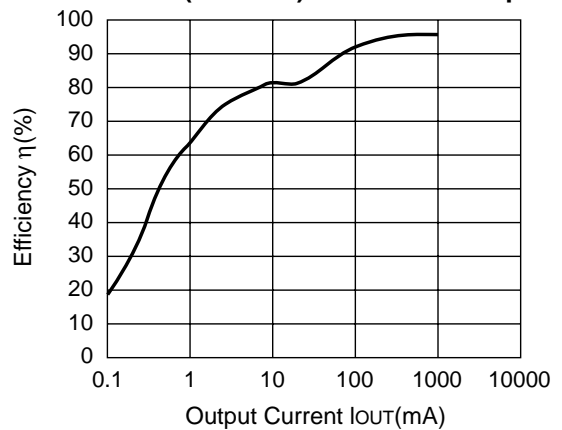

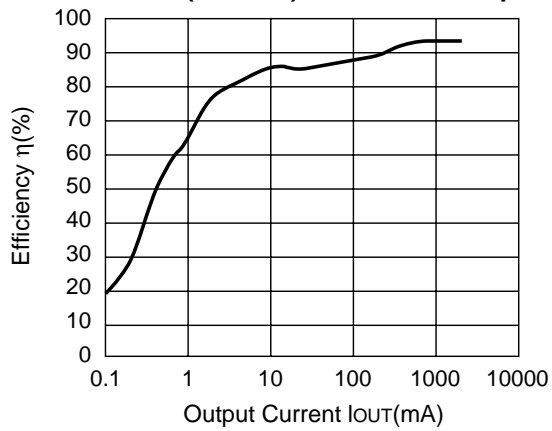
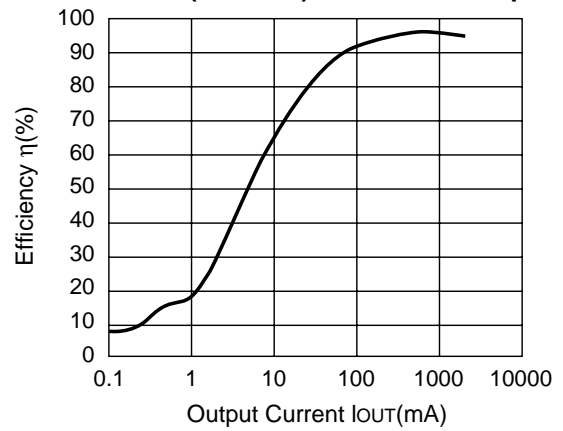
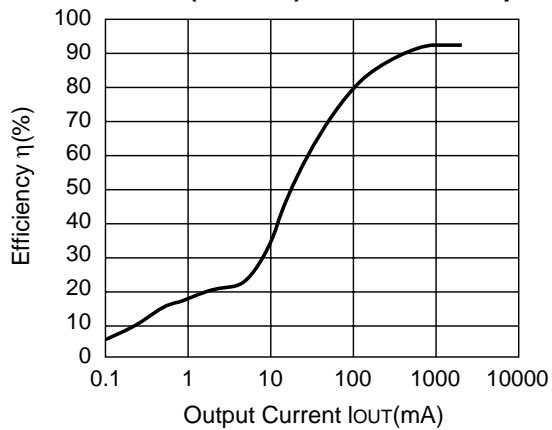
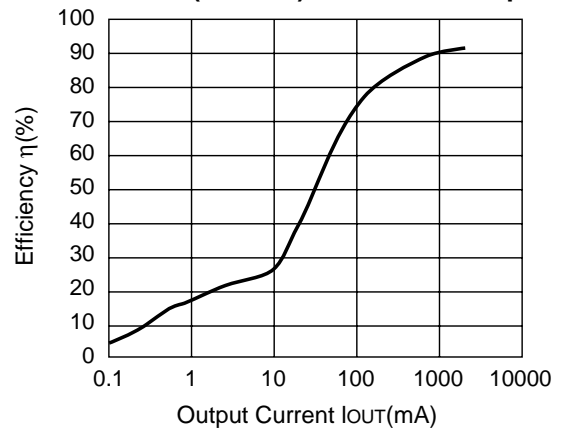
R1224N502L ($V_{IN}=10V$) CDRH127-27 μ HR1224N502M ($V_{IN}=6.5V$) CDRH127-27 μ HR1224N502M ($V_{IN}=12V$) CDRH127-27 μ HR1224N502M ($V_{IN}=15V$) CDRH127-27 μ H

*Note: Typical characteristics 2) are obtained with using the following components;

PMOS: IRF7406 (IR)

L : CDRH127-100MC (Sumida: 10 μ H)

SD : RB083L-20 (Rohm)

C1 : 25SC47 (Sanyo/OS-con: 47 μ F/25V) \times 2

C2 : 0.1 μ F (Ceramic Type)

C3 : 10SA220 (Sanyo/OS-con: 220 μ F/10V)

R1 : 10 Ω

3) Ripple Voltage vs. Output Current

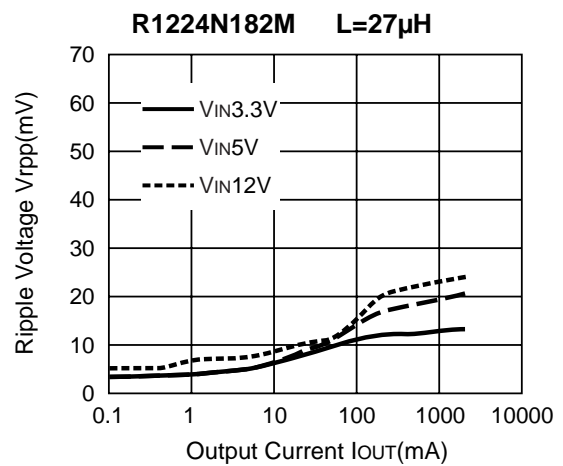
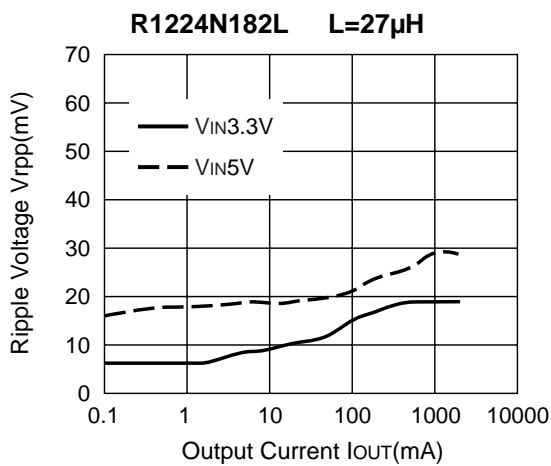
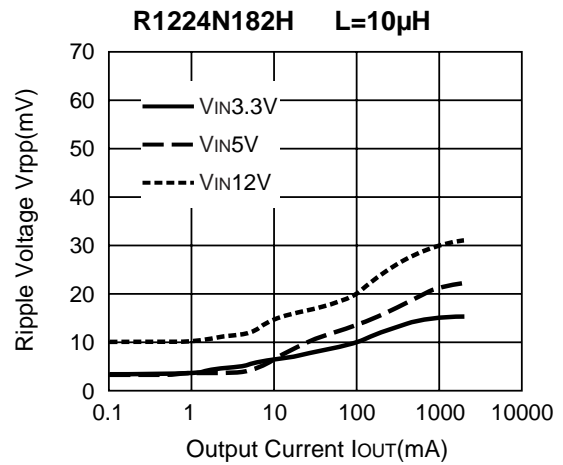
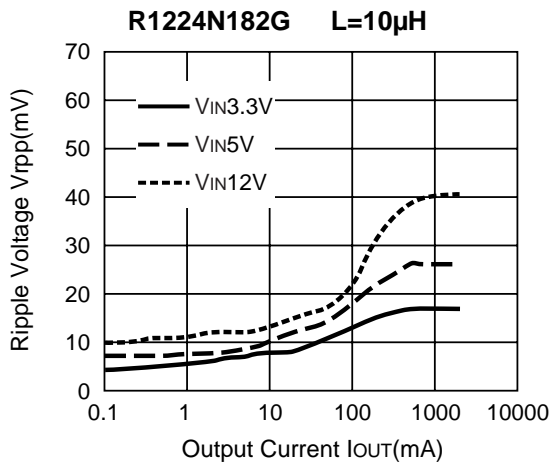
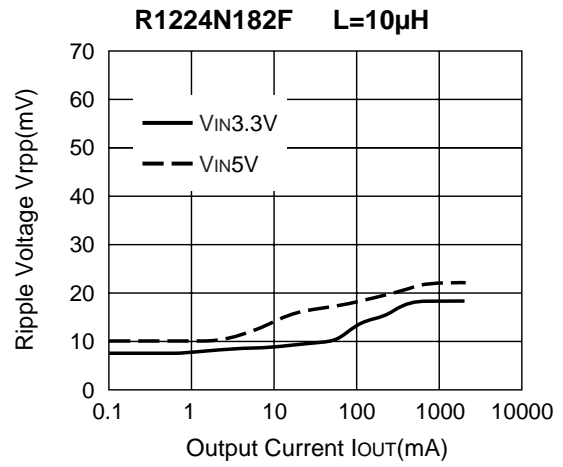
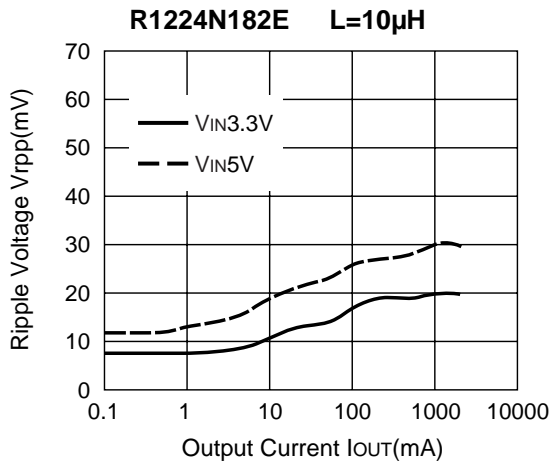

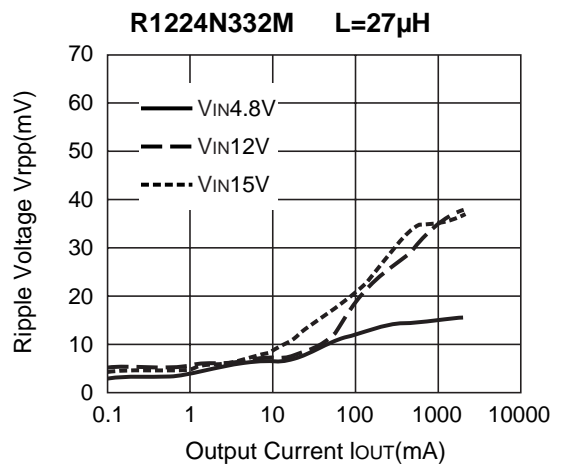
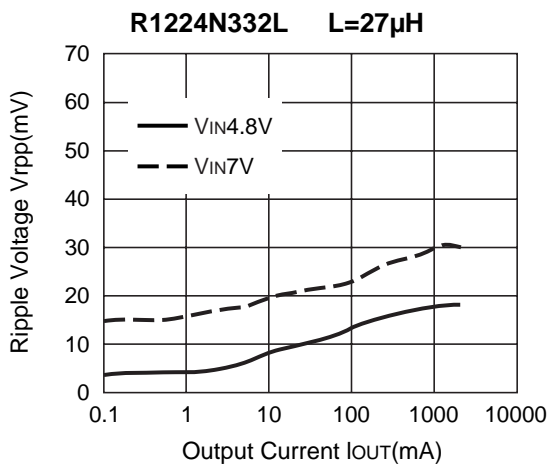
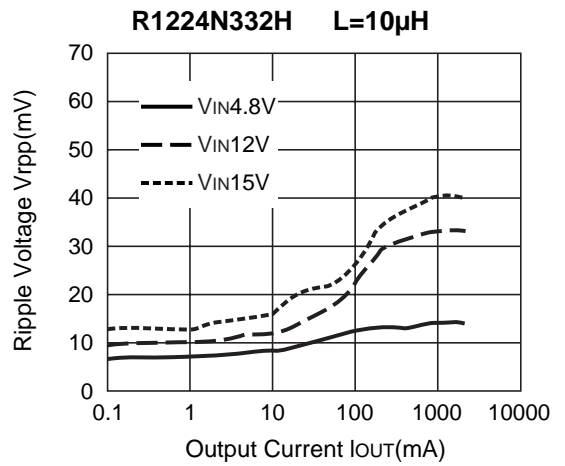
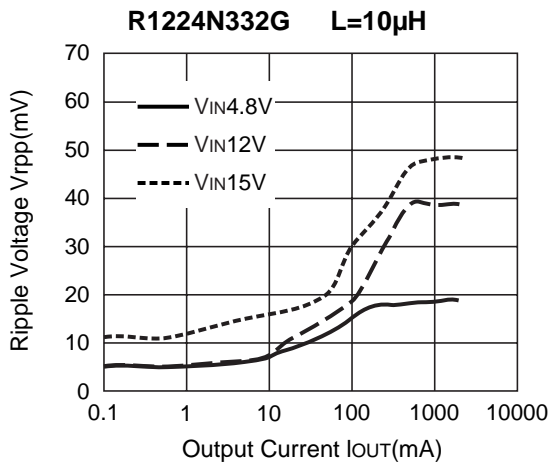
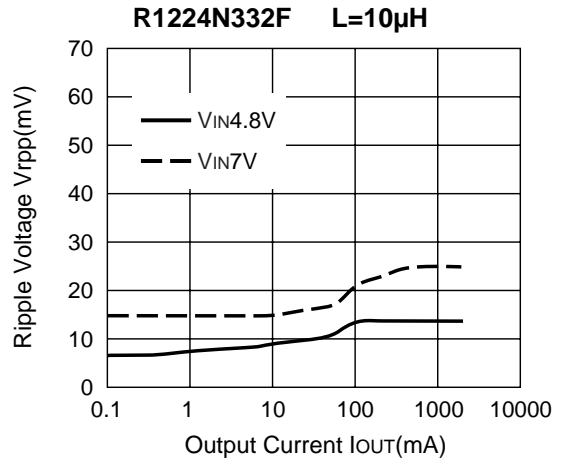
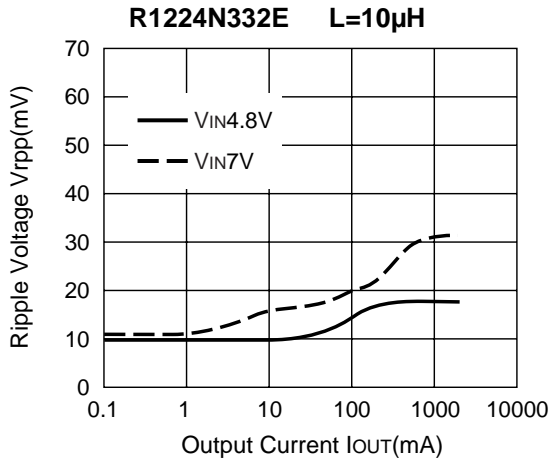

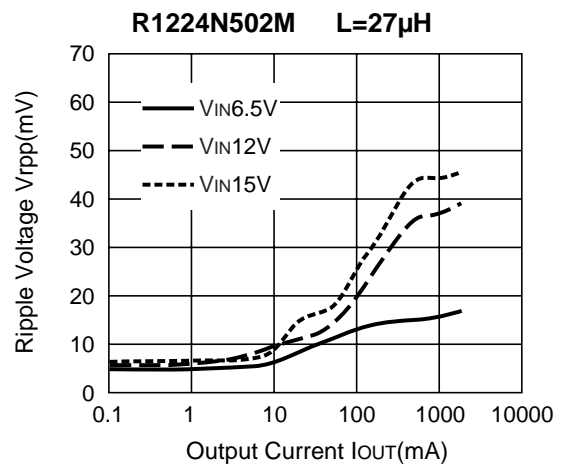
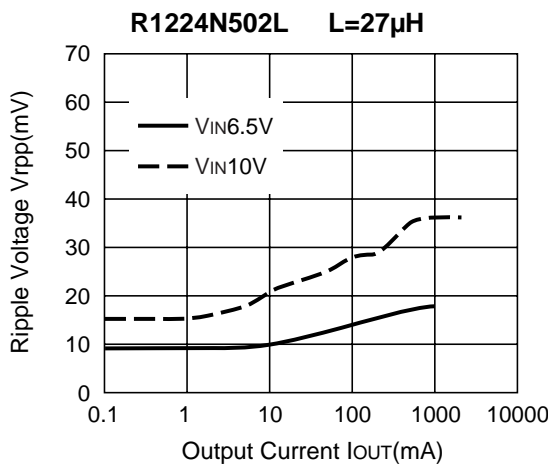
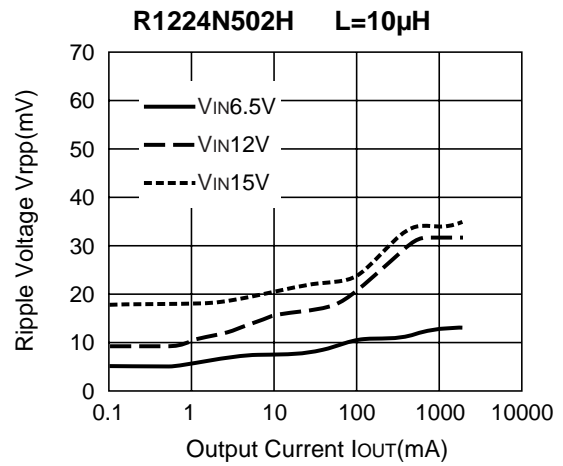
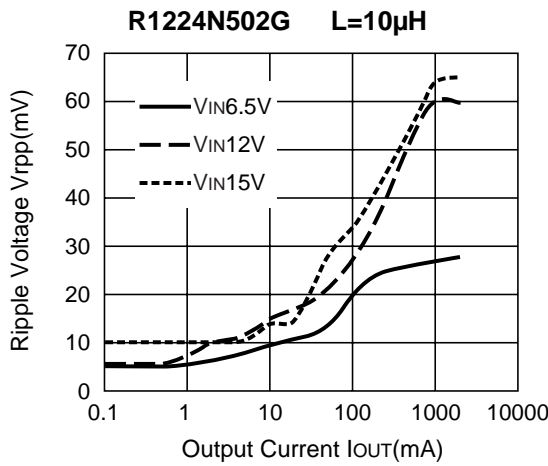
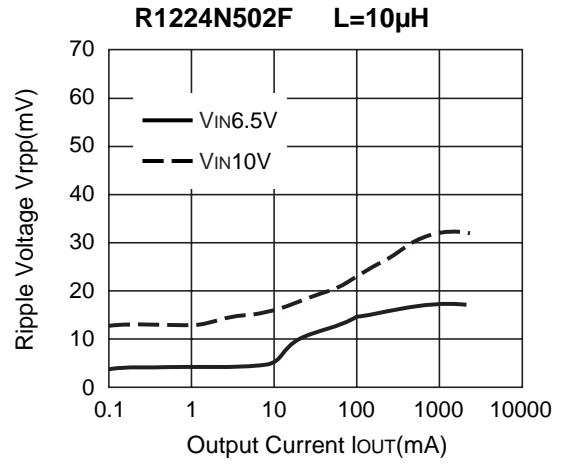
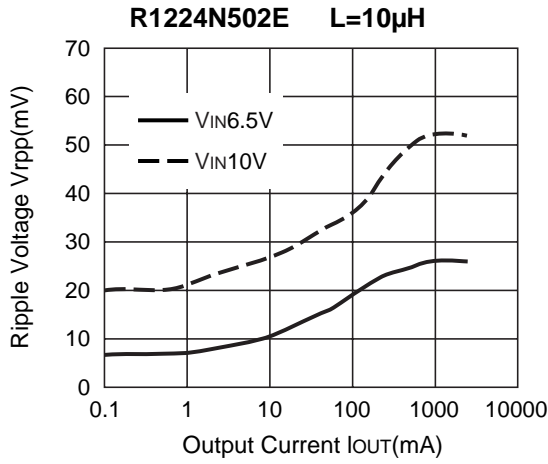

4) Output Voltage vs. Input Voltage

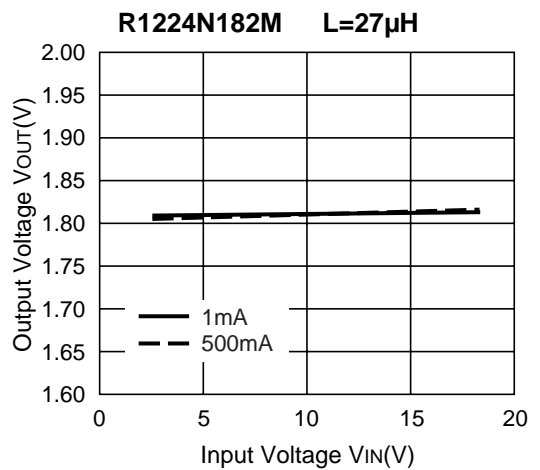
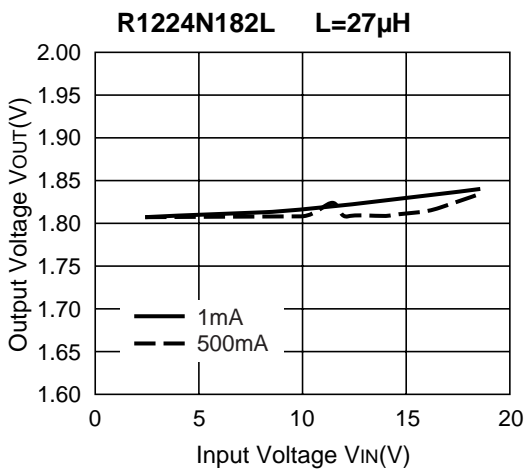
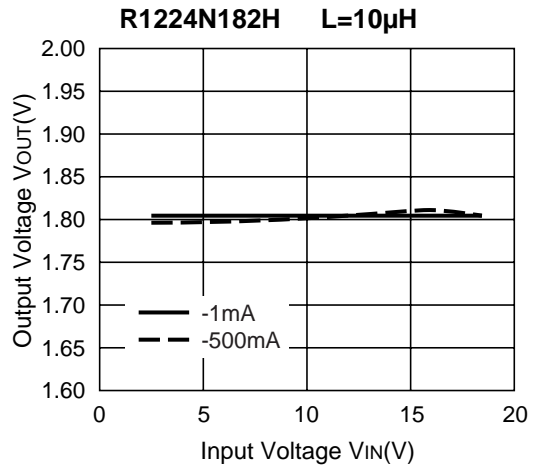
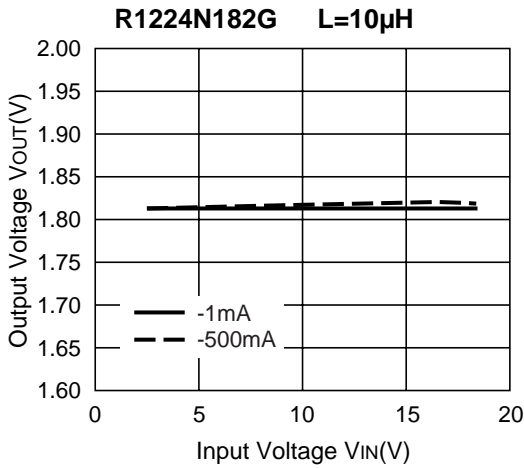
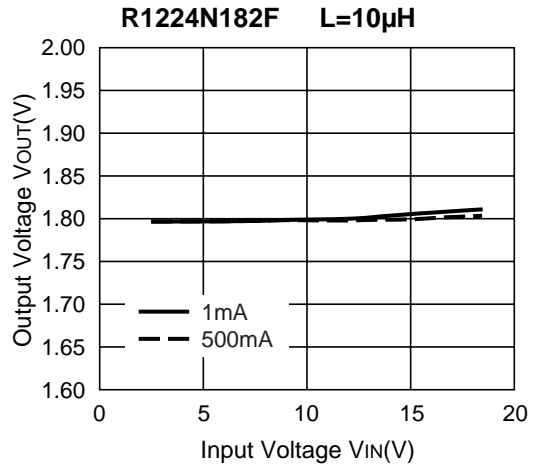
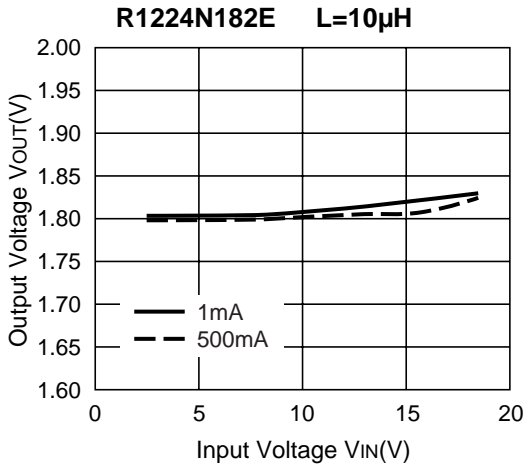

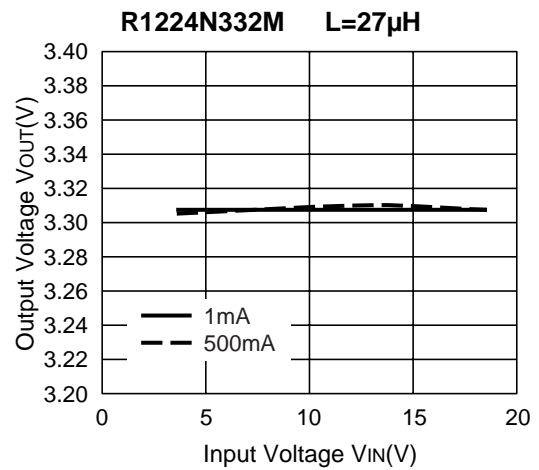
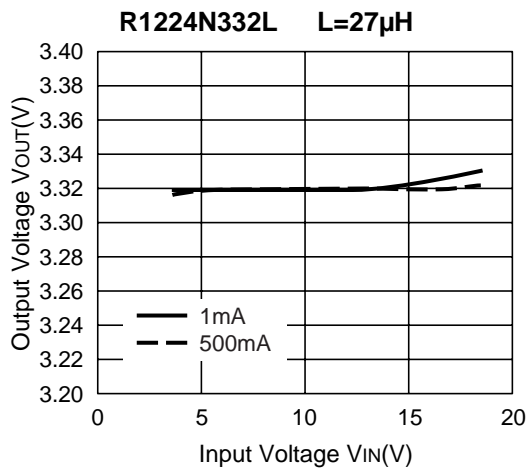
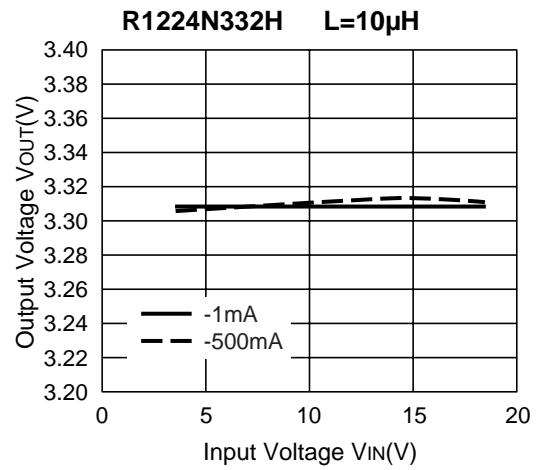
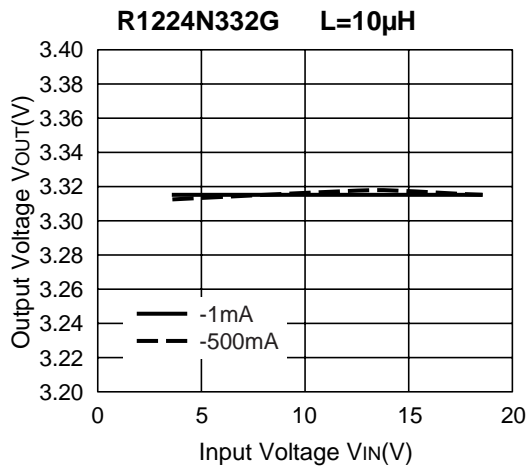
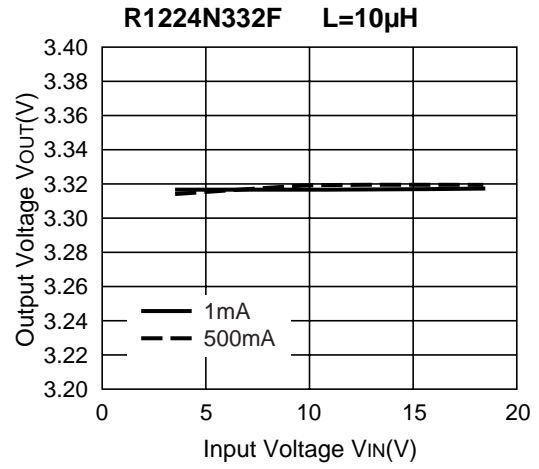
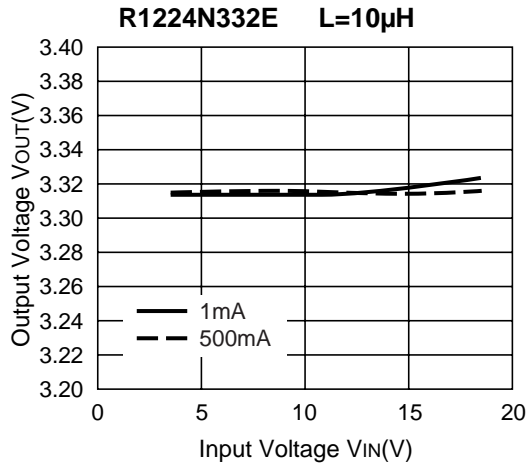

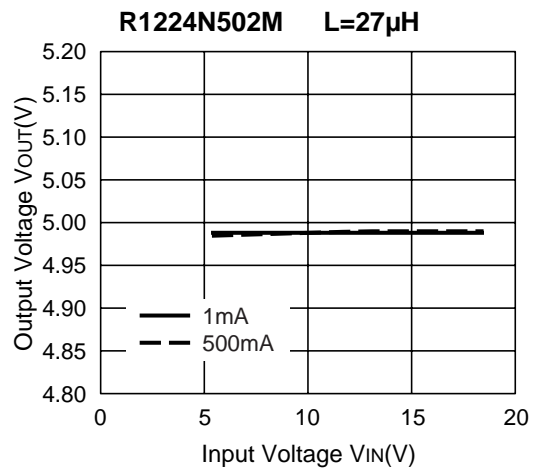
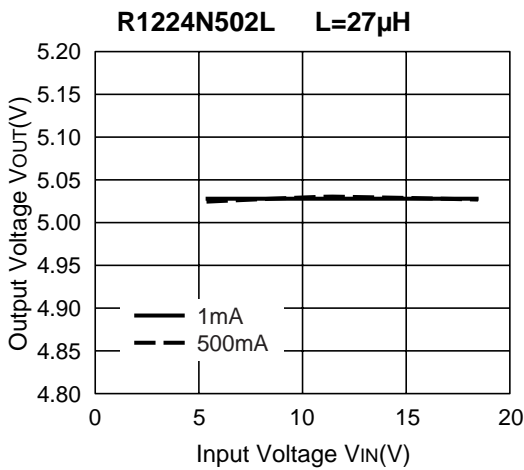
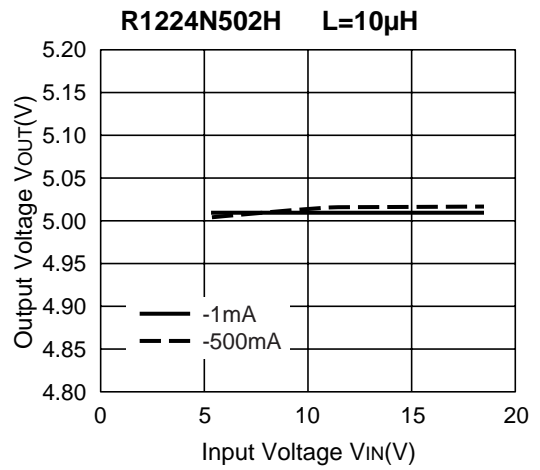
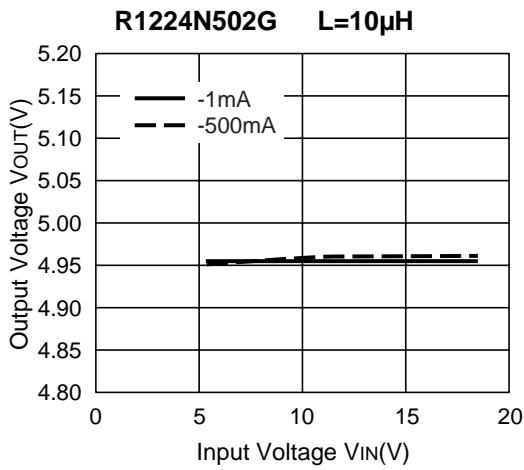
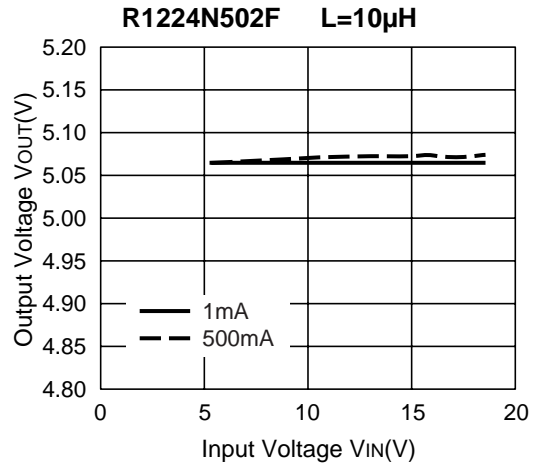
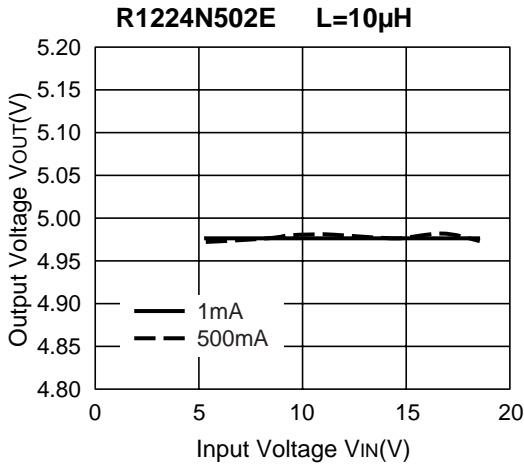

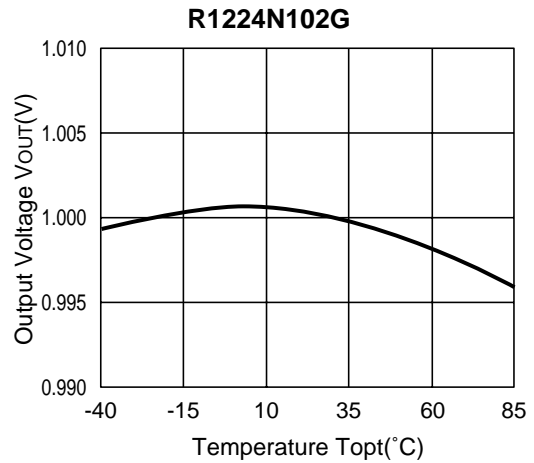
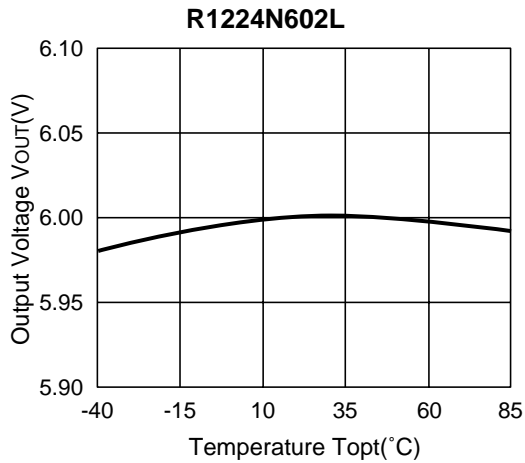
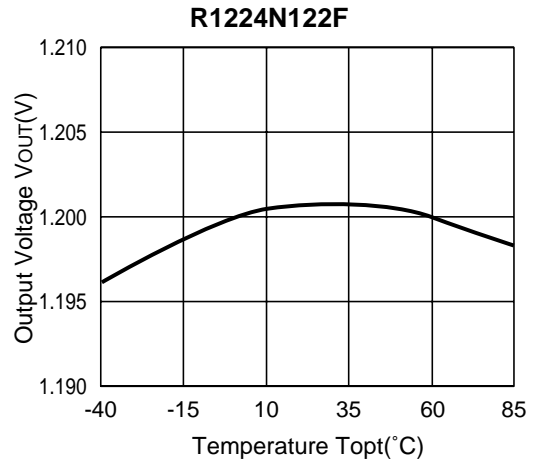
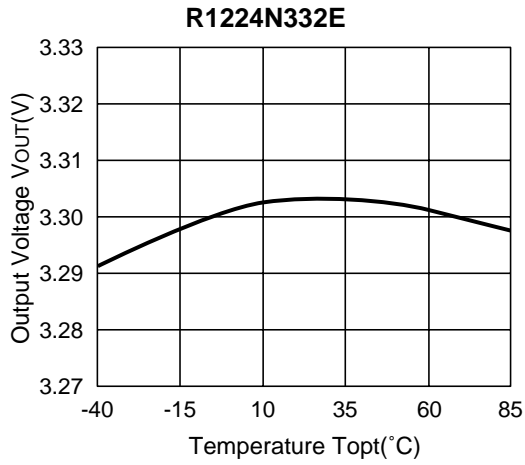
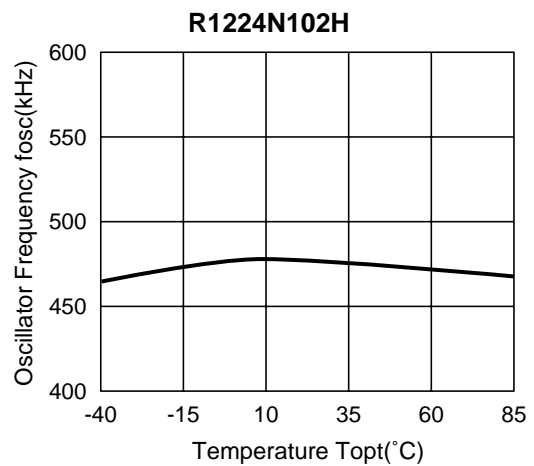
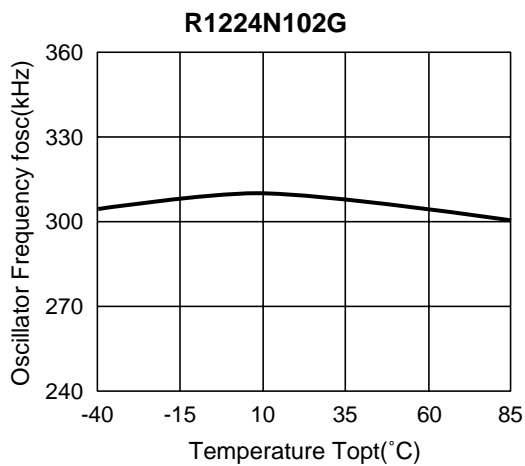
5) Output Voltage vs. Temperature**6) Oscillator Frequency vs. Temperature**

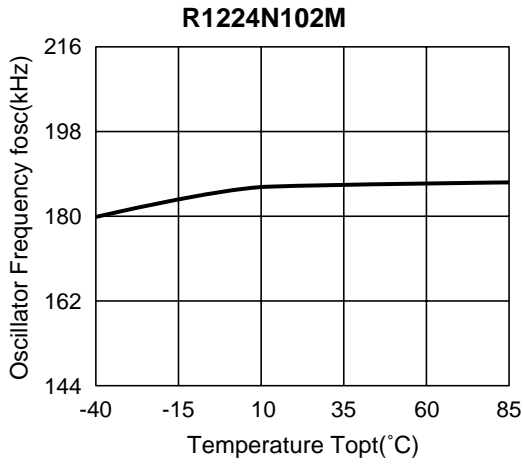

7) Supply Current vs. Temperature

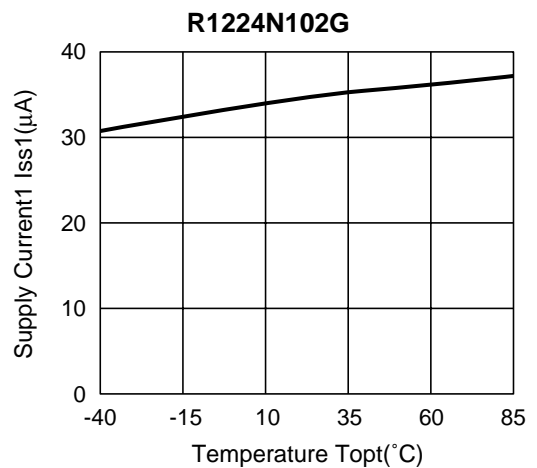
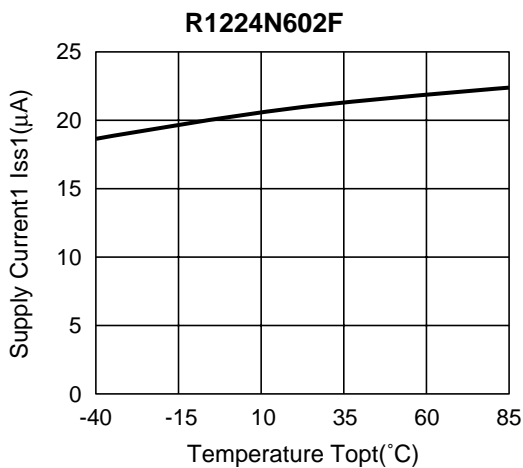
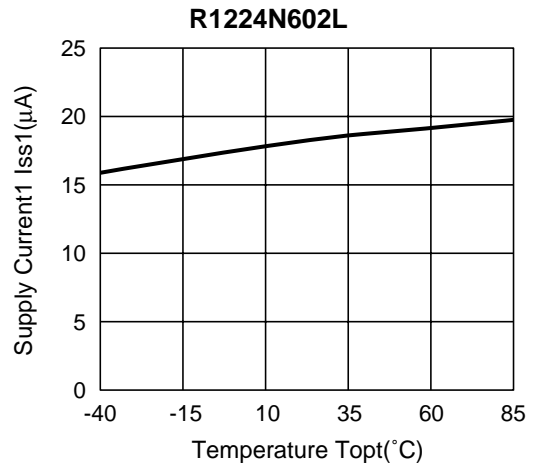
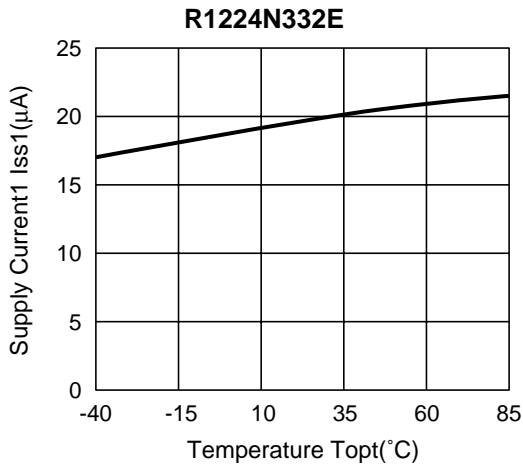

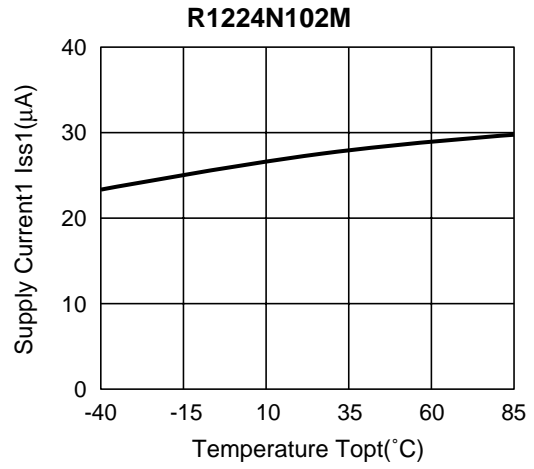
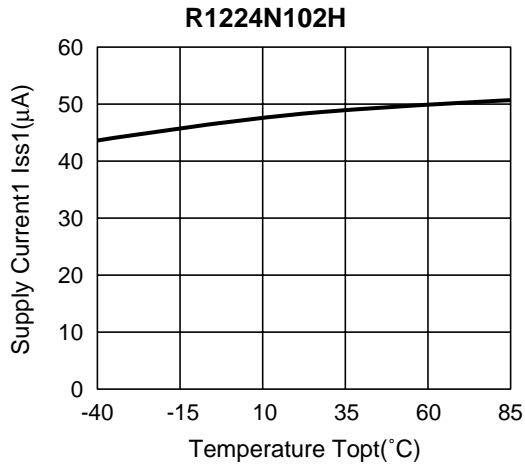

8) Soft-start time vs. Temperature

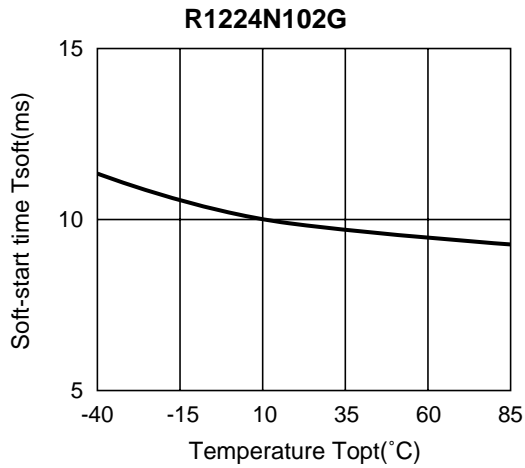

9) Delay Time for Protection vs. Temperature

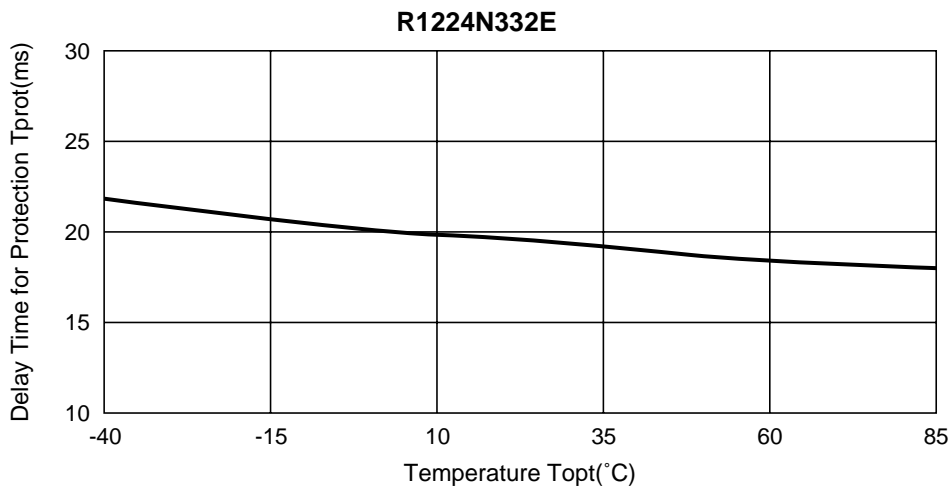

10) EXT "H" Output Current vs. Temperature

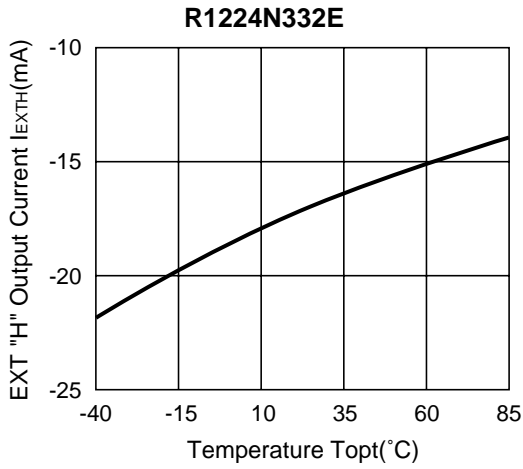

11) EXT "L" Output Current vs. Temperature

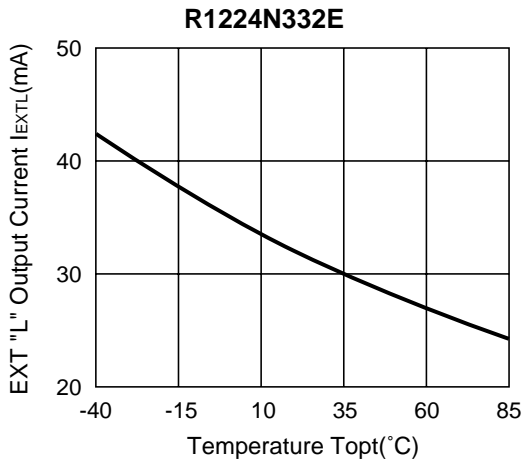

12) Load Transient Response

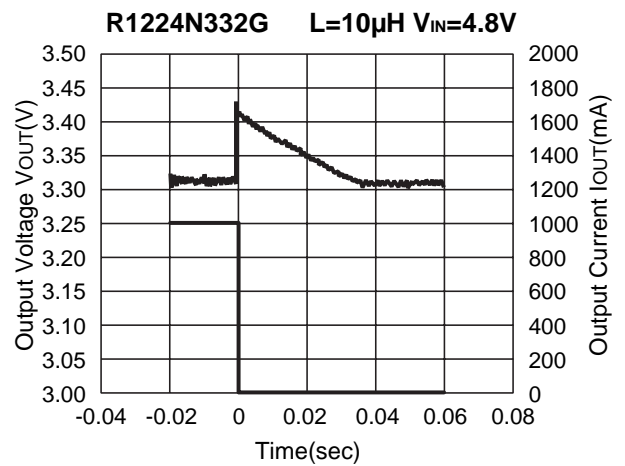
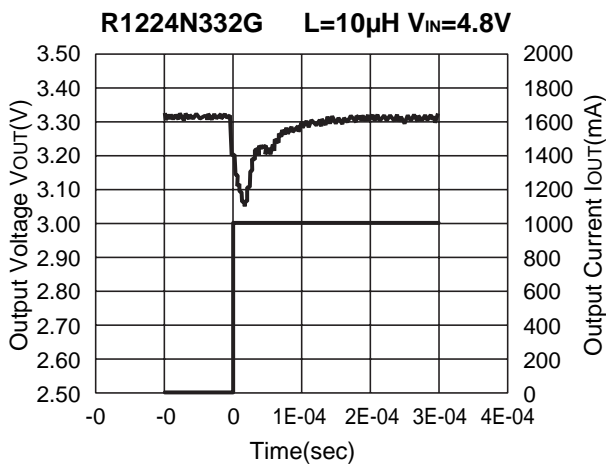

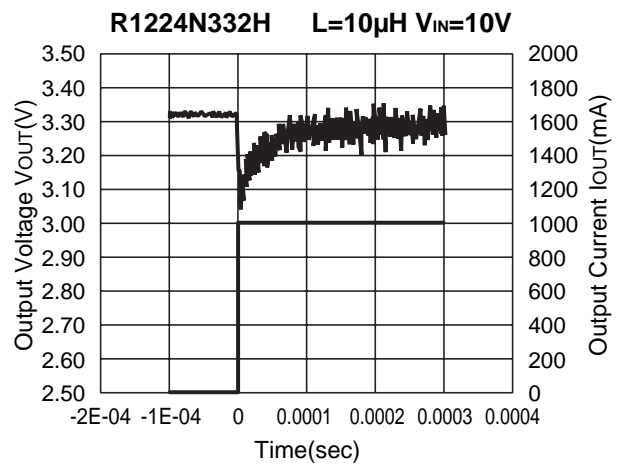
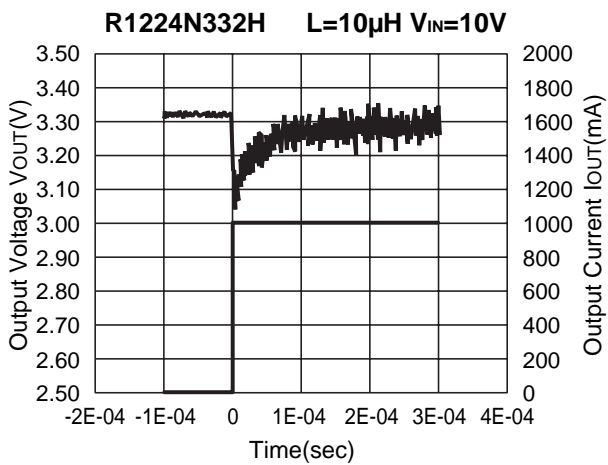
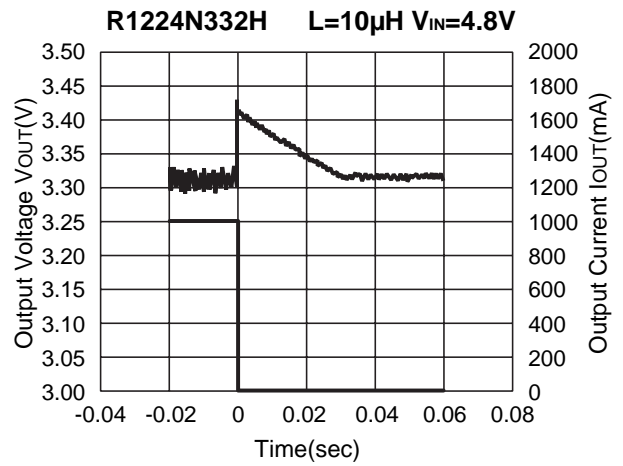
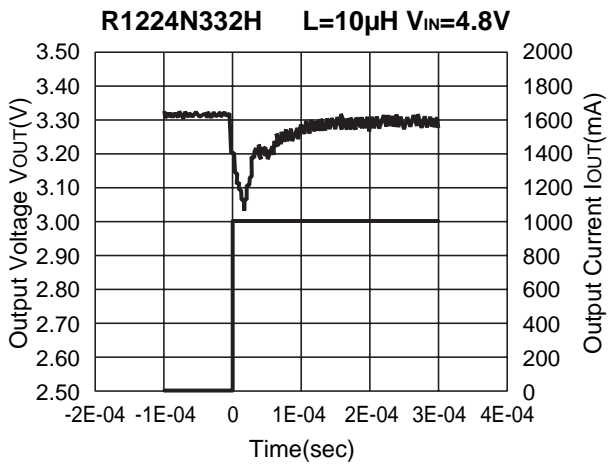
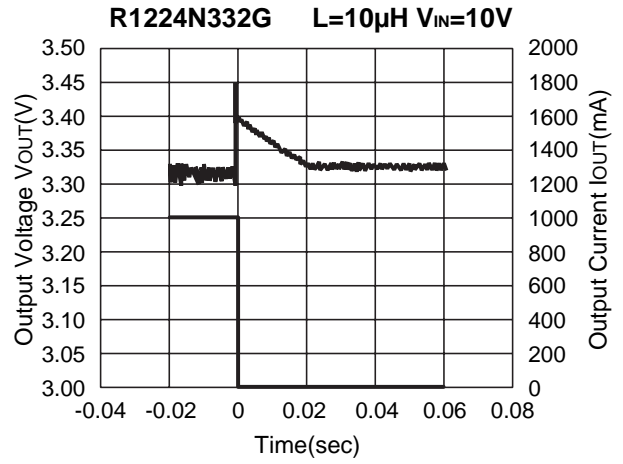
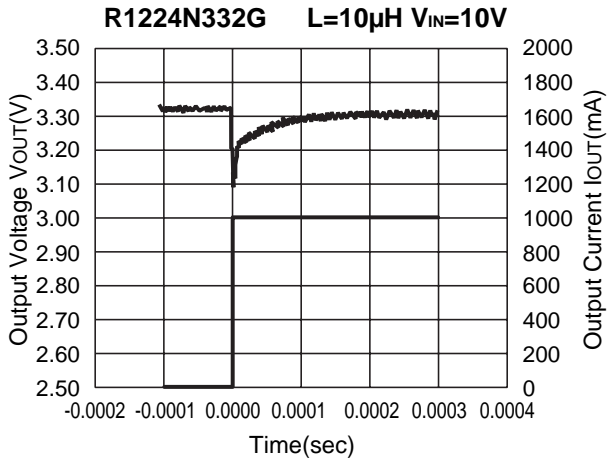

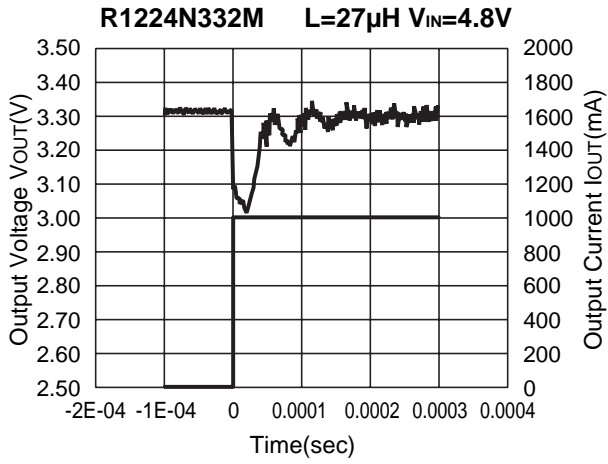

12) UVLO Voltage vs. Temperature

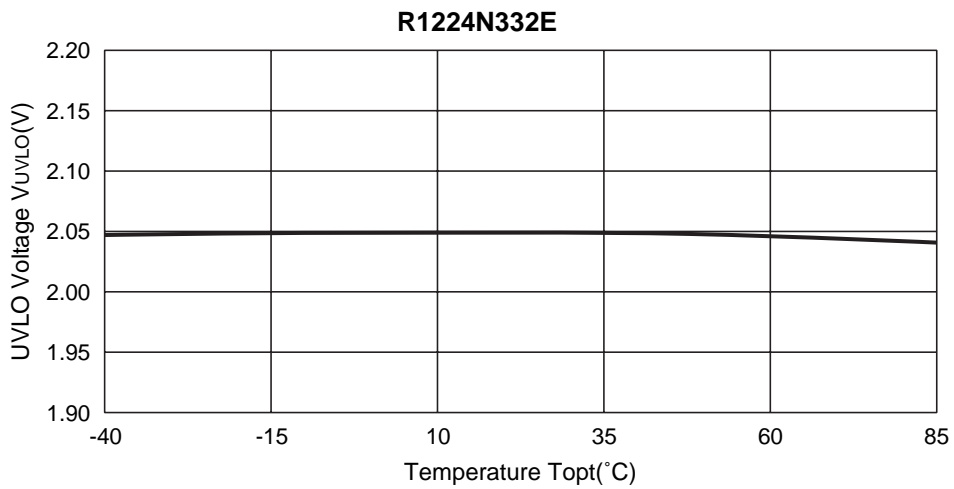

POWER DISSIPATION (SOT-23-5)

This specification is at mounted on board. Power Dissipation (P_D) depends on conditions of mounting on board. This specification is based on the measurement at the condition below:

(Power Dissipation (SOT-23-5) is substitution of SOT-23-6.)

Measurement Conditions

| | |
|------------------|--|
| | Standard Land Pattern |
| Environment | Mounting on Board (Wind velocity=0m/s) |
| Board Material | Glass cloth epoxy plactic (Double sided) |
| Board Dimensions | 40mm × 40mm × 1.6mm |
| Copper Ratio | Top side : Approx. 50% , Back side : Approx. 50% |
| Through-hole | φ0.5mm × 44pcs |

Measurement Result

($T_{opt}=25^{\circ}C, T_{jmax}=125^{\circ}C$)

| | | |
|--------------------|--|-------------------|
| | Standard Land Pattern | Free Air |
| Power Dissipation | 420mW | 250mW |
| Thermal Resistance | $\theta_{ja}=(125-25^{\circ}C)/0.42W=263^{\circ}C/W$ | 400 $^{\circ}C/W$ |

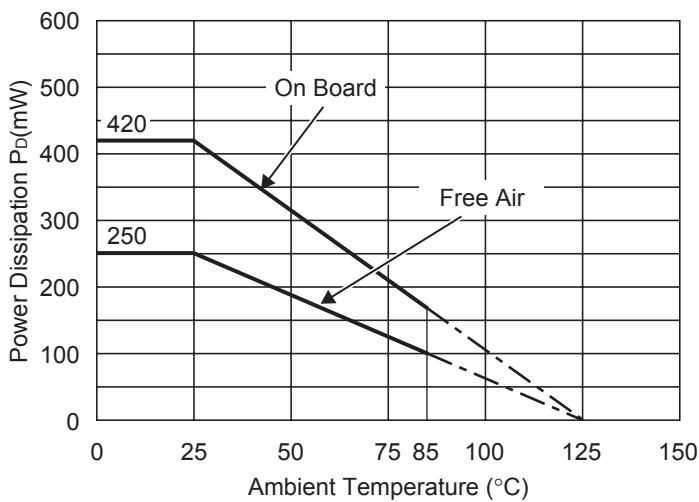

Power Dissipation



Measurement Board Pattern

○ IC Mount Area Unit : mm

RECOMMENDED LAND PATTERN



R1224N SERIES MARK SPECIFICATION

● **SOT-23-5 (SC-74A)**



①, ②, ③ : Product Code (refer to Part Number vs. Product Code)
 ④, ⑤ : Lot Number

● **Part Number vs. Product Code**

| Part Number | Product Code | | |
|-------------|--------------|---|---|
| | ① | ② | ③ |
| R1224N102G | G | 1 | 0 |
| R1224N122G | G | 1 | 2 |
| R1224N152G | G | 1 | 5 |
| R1224N182G | G | 1 | 8 |
| R1224N252G | G | 2 | 5 |
| R1224N302G | G | 3 | 0 |
| R1224N332G | G | 3 | 3 |
| R1224N362G | G | 3 | 6 |
| R1224N402G | G | 4 | 0 |
| R1224N502G | G | 5 | 0 |
| R1224N552G | G | 5 | 5 |
| R1224N602G | G | 6 | 0 |
| R1224N122E | E | 1 | 2 |
| R1224N152E | E | 1 | 5 |
| R1224N182E | E | 1 | 8 |
| R1224N222E | E | 2 | 2 |
| R1224N252E | E | 2 | 5 |
| R1224N262E | E | 2 | 6 |
| R1224N272E | E | 2 | 7 |
| R1224N302E | E | 3 | 0 |
| R1224N332E | E | 3 | 3 |
| R1224N502E | E | 5 | 0 |
| R1224N552E | E | 5 | 5 |
| R1224N602E | E | 6 | 0 |
| | | | |
| | | | |
| | | | |

| Part Number | Product Code | | |
|-------------|--------------|---|---|
| | ① | ② | ③ |
| R1224N102H | H | 1 | 0 |
| R1224N122H | H | 1 | 2 |
| R1224N132H | H | 1 | 3 |
| R1224N152H | H | 1 | 5 |
| R1224N182H | H | 1 | 8 |
| R1224N252H | H | 2 | 5 |
| R1224N302H | H | 3 | 0 |
| R1224N332H | H | 3 | 3 |
| R1224N362H | H | 3 | 6 |
| R1224N402H | H | 4 | 0 |
| R1224N462H | H | 4 | 6 |
| R1224N472H | H | 4 | 7 |
| R1224N502H | H | 5 | 0 |
| R1224N552H | H | 5 | 5 |
| R1224N602H | H | 6 | 0 |
| R1224N122F | F | 1 | 2 |
| R1224N152F | F | 1 | 5 |
| R1224N182F | F | 1 | 8 |
| R1224N252F | F | 2 | 5 |
| R1224N262F | F | 2 | 6 |
| R1224N302F | F | 3 | 0 |
| R1224N322F | F | 3 | 2 |
| R1224N332F | F | 3 | 3 |
| R1224N362F | F | 3 | 6 |
| R1224N502F | F | 5 | 0 |
| R1224N552F | F | 5 | 5 |
| R1224N602F | F | 6 | 0 |

| Part Number | Product Code | | |
|-------------|--------------|---|---|
| | ① | ② | ③ |
| R1224N102M | M | 1 | 0 |
| R1224N122M | M | 1 | 2 |
| R1224N152M | M | 1 | 5 |
| R1224N182M | M | 1 | 8 |
| R1224N252M | M | 2 | 5 |
| R1224N302M | M | 3 | 0 |
| R1224N312M | M | 3 | 1 |
| R1224N332M | M | 3 | 3 |
| R1224N502M | M | 5 | 0 |
| R1224N552M | M | 5 | 5 |
| R1224N602M | M | 6 | 0 |
| R1224N122 L | L | 1 | 2 |
| R1224N152 L | L | 1 | 5 |
| R1224N182 L | L | 1 | 8 |
| R1224N252 L | L | 2 | 5 |
| R1224N302 L | L | 3 | 0 |
| R1224N312 L | L | 3 | 1 |
| R1224N332 L | L | 3 | 3 |
| R1224N502 L | L | 5 | 0 |
| R1224N552 L | L | 5 | 5 |
| R1224N602 L | L | 6 | 0 |
| | | | |
| | | | |
| | | | |

Данный компонент на территории Российской Федерации

Вы можете приобрести в компании MosChip.

Для оперативного оформления запроса Вам необходимо перейти по данной ссылке:

<http://moschip.ru/get-element>

Вы можете разместить у нас заказ для любого Вашего проекта, будь то серийное производство или разработка единичного прибора.

В нашем ассортименте представлены ведущие мировые производители активных и пассивных электронных компонентов.

Нашей специализацией является поставка электронной компонентной базы двойного назначения, продукции таких производителей как XILINX, Intel (ex.ALTERA), Vicor, Microchip, Texas Instruments, Analog Devices, Mini-Circuits, Amphenol, Glenair.

Сотрудничество с глобальными дистрибьюторами электронных компонентов, предоставляет возможность заказывать и получать с международных складов практически любой перечень компонентов в оптимальные для Вас сроки.

На всех этапах разработки и производства наши партнеры могут получить квалифицированную поддержку опытных инженеров.

Система менеджмента качества компании отвечает требованиям в соответствии с ГОСТ Р ИСО 9001, ГОСТ РВ 0015-002 и ЭС РД 009

Офис по работе с юридическими лицами:

105318, г.Москва, ул.Щербаковская д.3, офис 1107, 1118, ДЦ «Щербаковский»

Телефон: +7 495 668-12-70 (многоканальный)

Факс: +7 495 668-12-70 (доб.304)

E-mail: info@moschip.ru

Skype отдела продаж:

moschip.ru

moschip.ru_4

moschip.ru_6

moschip.ru_9