

**RoHS Qxx25xx & Qxx25xHx Series**



**Description**

25 Amp bi-directional solid state switch series is designed for AC switching and phase control applications such as motor speed and temperature modulation controls, lighting controls, and static switching relays.

Standard type devices normally operate in Quadrants I & III triggered from AC line.

Alternistor type devices only operate in quadrants I, II, & III and are used in circuits requiring high dv/dt capability.

**Features & Benefits**

- RoHS compliant
- Glass – passivated junctions
- Voltage capability up to 1000 V
- Surge capability up to 250 A

**Agency Approval**

Agency	Agency File Number
	TO-220L, TO-218K, TO-218J & Fastpak Packages: E71639

**Main Features**

Symbol	Value	Unit
$I_{T(RMS)}$	25	A
$V_{DRM}/V_{RRM}$	1000	V
$I_{GT}$	50 to 80	mA

**Applications**

Excellent for AC switching and phase control applications such as heating, lighting, and motor speed controls.

Typical applications are AC solid-state switches, industrial power tools, exercise equipment, white goods and commercial appliances.

Alternistor Triacs (no snubber required) are used in applications with extremely inductive loads requiring highest commutation performance.

Internally constructed isolated packages are offered for ease of heat sinking with highest isolation voltage.

**Schematic Symbol**



**Absolute Maximum Ratings – Standard Triac**

Symbol	Parameter	Test Conditions		Value	Unit
$I_{T(RMS)}$	RMS on-state current	Qxx25R5 Qxx25N5	$T_c = 85^\circ\text{C}$	25	A
		Qxx25P5	$T_c = 57^\circ\text{C}$		
$I_{TSM}$	Peak non-repetitive surge current	Qxx25R5 Qxx25N5	single half cycle; $f = 50\text{Hz}$ ; $T_j$ (initial) = $25^\circ\text{C}$	167	A
			single half cycle; $f = 60\text{Hz}$ ; $T_j$ (initial) = $25^\circ\text{C}$	200	
		Qxx25P5	single half cycle; $f = 50\text{Hz}$ ; $T_j$ (initial) = $25^\circ\text{C}$	220	
			single half cycle; $f = 60\text{Hz}$ ; $T_j$ (initial) = $25^\circ\text{C}$	250	
$I^2t$	$I^2t$ Value for fusing	Qxx25R5 Qxx25N5	$t_p = 8.3\text{ms}$	166	$\text{A}^2\text{s}$
		Qxx25P5		260	
di/dt	Critical rate-of-rise of on-state current	$f = 60\text{Hz}; T_j = 125^\circ\text{C}$		100	$\text{A}/\mu\text{s}$
$I_{GTM}$	Peak gate current	$T_j = 125^\circ\text{C}$		2	A
$P_{G(AV)}$	Average gate power dissipation	$T_j = 125^\circ\text{C}$		0.5	W
$T_{stg}$	Storage temperature range			-40 to 125	$^\circ\text{C}$
$T_j$	Operating junction temperature range	Qxx25R5 Qxx25N5		-40 to 125	$^\circ\text{C}$
		Qxx25P5		-25 to 125	

**Absolute Maximum Ratings – Alternistor Triac**

Symbol	Parameter	Test Conditions		Value	Unit
$I_{T(RMS)}$	RMS on-state current	Qxx25LH5 Qxx25L6	$T_c = 65^\circ\text{C}$	25	A
		Qxx25K6 Qxx25J6	$T_c = 85^\circ\text{C}$		
		Qxx25RH5 Qxx25NH5 Qxx25R6 Qxx25NH6	$T_c = 95^\circ\text{C}$		
$I_{TSM}$	Peak non-repetitive surge current	single half cycle; $f = 50\text{Hz}$ ; $T_j$ (initial) = $25^\circ\text{C}$		208	A
		single half cycle; $f = 60\text{Hz}$ ; $T_j$ (initial) = $25^\circ\text{C}$		250	
$I^2t$	$I^2t$ Value for fusing	$t_p = 8.3\text{ms}$		260	$\text{A}^2\text{s}$
di/dt	Critical rate-of-rise of on-state current	$f = 60\text{Hz}; T_j = 125^\circ\text{C}$		100	$\text{A}/\mu\text{s}$
$I_{GTM}$	Peak gate current	$T_j = 125^\circ\text{C}$		2	A
$P_{G(AV)}$	Average gate power dissipation	$T_j = 125^\circ\text{C}$		0.5	W
$T_{stg}$	Storage temperature range			-40 to 125	$^\circ\text{C}$
$T_j$	Operating junction temperature range			-40 to 125	$^\circ\text{C}$

Note: xx = voltage

**Electrical Characteristics ( $T_J = 25^\circ\text{C}$ , unless otherwise specified) — Standard Triac**

Symbol	Test Conditions	Quadrant		Value		Unit
				Qxx25R5 Qxx25N5	Qxx25P5	
$I_{GT}$	$V_D = 12\text{V}; R_L = 60\ \Omega$	I – II – III	MAX.	50		mA
		IV	TYP.	120		
$V_{GT}$		I – II – III	MAX.	1.3		V
		IV	TYP.	2.5		
$V_{GD}$	$V_D = V_{DRM}; R_L = 3.3\ \text{k}\Omega; T_J = 125^\circ\text{C}$	ALL	MIN.	0.2		V
$I_H$	$I_T = 400\text{mA}$ (initial)		MAX.	100	50	mA
$dv/dt$	$V_D = V_{DRM};$ Gate Open; $T_J = 125^\circ\text{C}$	400V	MIN.	275	—	V/ $\mu\text{s}$
		600V		225	475	
		800V		200	400	
	$V_D = V_{DRM};$ Gate Open; $T_J = 100^\circ\text{C}$	1000V		200	—	
$(dv/dt)c$	$(di/dt)c = 13.3\ \text{A/ms}; T_J = 125^\circ\text{C}$		MIN.	5		V/ $\mu\text{s}$
$t_{gt}$	$I_G = 2 \times I_{GT}; PW = 15\ \mu\text{s}; I_T = 35.4\ \text{A}$		TYP.	4	3	$\mu\text{s}$

**Electrical Characteristics ( $T_J = 25^\circ\text{C}$ , unless otherwise specified) — Alternistor Triac**

Symbol	Test Conditions	Quadrant		Value		Unit
				Qxx25RH5 Qxx25LH5 Qxx25NH5	Qxx25R6 Qxx25L6 Qxx25NH6 Qxx25K6 Qxx25J6	
$I_{GT}$	$V_D = 12\text{V}; R_L = 60\ \Omega$	I – II – III	MAX.	50	80	mA
$V_{GT}$		I – II – III	MAX.	1.3		V
$V_{GD}$	$V_D = V_{DRM}; R_L = 3.3\ \text{k}\Omega; T_J = 125^\circ\text{C}$	I – II – III	MIN.	0.2		V
$I_H$	$I_T = 400\text{mA}$ (initial)		MAX.	50	100	mA
$dv/dt$	$V_D = V_{DRM};$ Gate Open; $T_J = 125^\circ\text{C}$	400V	MIN.	575	600	V/ $\mu\text{s}$
		600V		500	600	
		800V		400	475	
	$V_D = V_{DRM};$ Gate Open; $T_J = 100^\circ\text{C}$	1000V		—	400	
$(dv/dt)c$	$(di/dt)c = 13.3\ \text{A/ms}; T_J = 125^\circ\text{C}$		MIN.	20	30	V/ $\mu\text{s}$
$t_{gt}$	$I_G = 2 \times I_{GT}; PW = 15\ \mu\text{s}; I_T = 35.4\ \text{A}$		TYP.	3	5	$\mu\text{s}$

**Static Characteristics**

Symbol	Test Conditions	Value		Unit			
					Qxx25R5 Qxx25N5 Qxx25xH5 Qxx25x6 Qxx25NH6	Qxx25P5	
$V_{TM}$	$I_T = 35.4\text{A}; t_p = 380\ \mu\text{s}$		MAX.	1.8	1.4	V	
$I_{DRM}/I_{RRM}$	$V_{DRM}/V_{RRM}$	$T_J = 25^\circ\text{C}$	600 – 800V	MAX.	10	100	$\mu\text{A}$
			1000V		20	—	
		$T_J = 100^\circ\text{C}$	600 – 800V		500	—	
			1000V		1000	—	
		$T_J = 125^\circ\text{C}$	600 – 800V		2000	5000	

Note: xx = voltage, x = package

**Thermal Resistances**

Symbol	Parameter	Value	Unit	
$R_{\theta(J-C)}$	Junction to case (AC)	Qxx25R5 / Qxx25N5 Qxx25R6 / Qxx25NH6 Qxx25RH5 / Qxx25NH5	0.89	°C/W
		Qxx25P5	1.6	
		Qxx25L6 / Qxx25LH5	2.0	
		Qxx25K6 / Qxx25J6	1.32	
$R_{\theta(J-A)}$	Junction to ambient	Qxx25Ry	45	°C/W
		Qxx25L6 / Qxx25LH5	50	

Note: xx = voltage, y = sensitivity

**Figure 1: Normalized DC Gate Trigger Current vs. Junction Temperature**

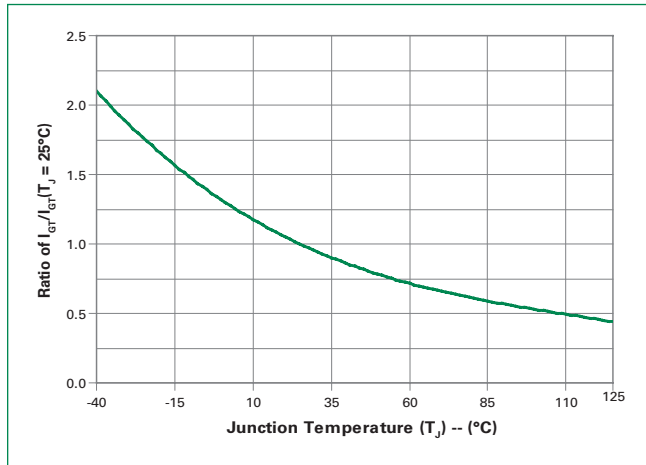

**Figure 2: Normalized DC Gate Trigger Voltage vs. Junction Temperature**

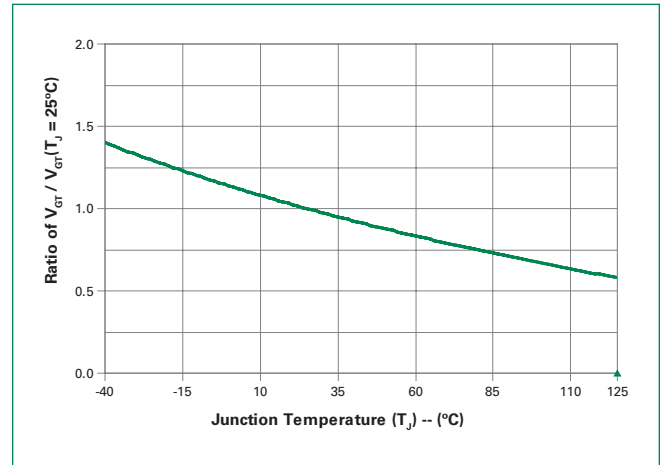

**Figure 3: Normalized DC Holding Current vs. Junction Temperature**

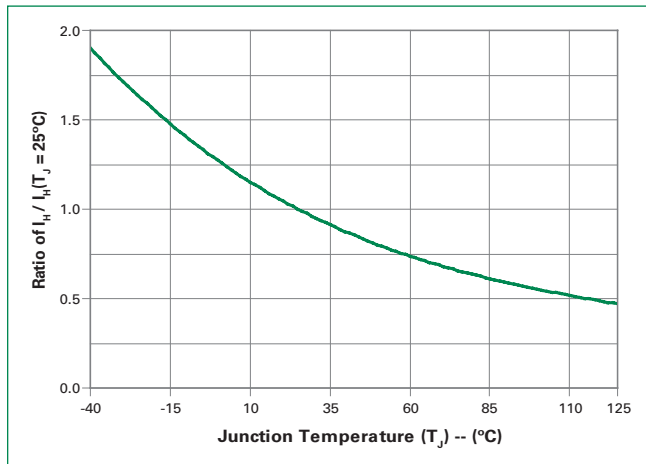

**Figure 4: On-State Current vs. On-State Voltage (Typical)**

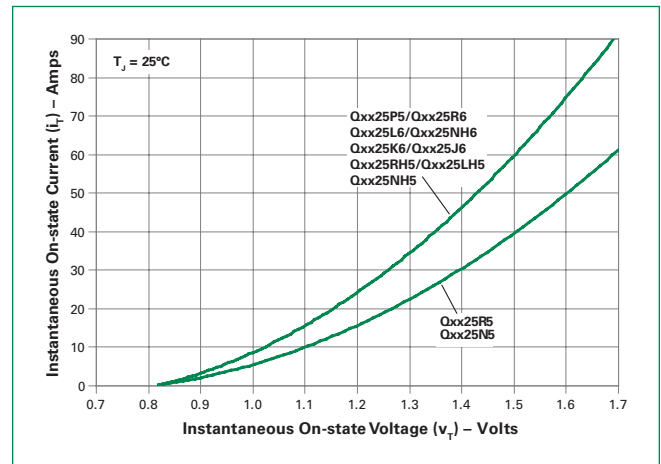

Figure 5: Power Dissipation (Typical) vs. RMS On-State Current

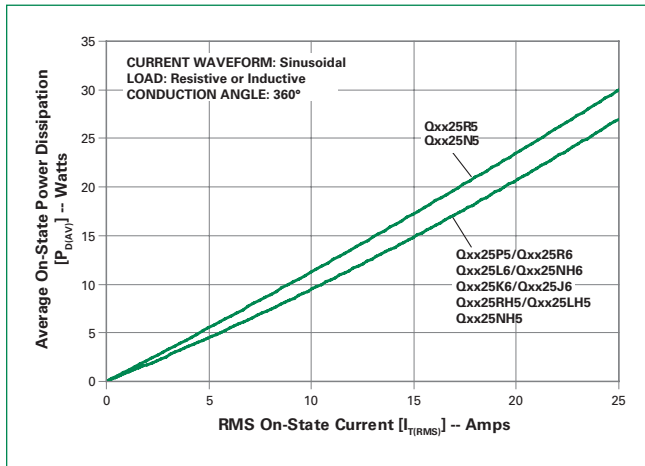

Figure 6: Maximum Allowable Case Temperature vs. RMS On-State Current

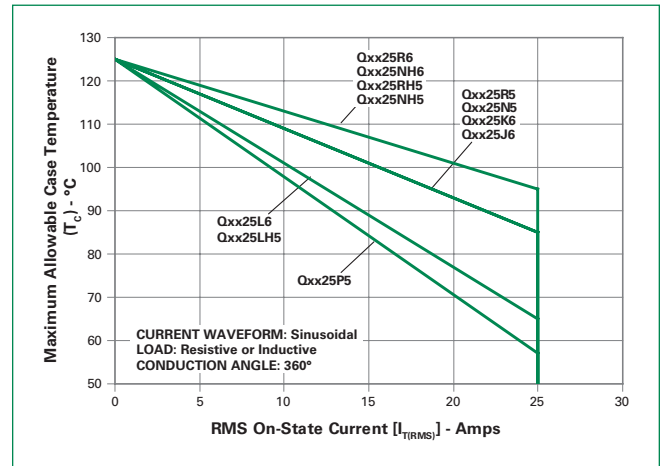

Figure 7: Maximum Allowable Ambient Temperature vs. RMS On-State Current (TO-220 packages only)

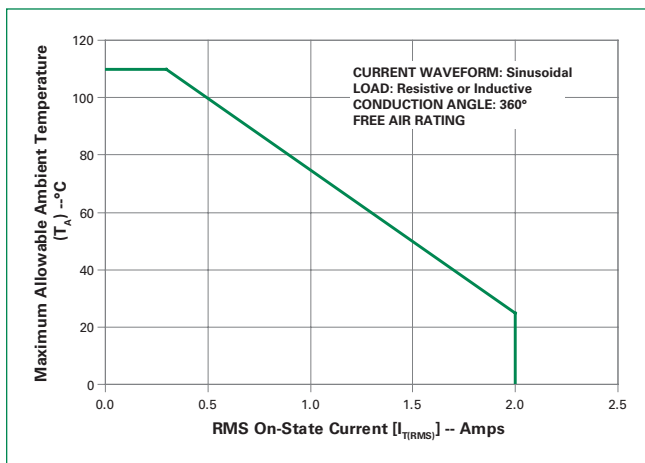
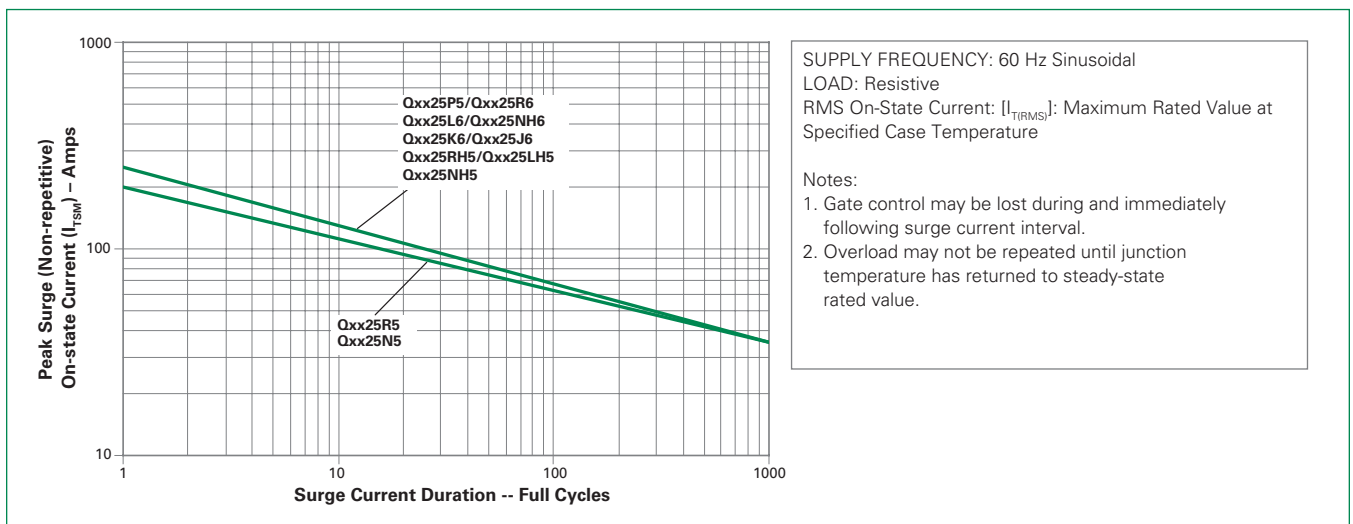

Figure 8: Surge Peak On-State Current vs. Number of Cycles



### Soldering Parameters

Reflow Condition		Pb – Free assembly
Pre Heat	- Temperature Min ( $T_{s(min)}$ )	150°C
	- Temperature Max ( $T_{s(max)}$ )	200°C
	- Time (min to max) ( $t_s$ )	60 – 180 secs
Average ramp up rate (Liquidus Temp ( $T_L$ ) to peak)		5°C/second max
$T_{s(max)}$ to $T_L$ - Ramp-up Rate		5°C/second max
Reflow	- Temperature ( $T_L$ ) (Liquidus)	217°C
	- Temperature ( $t_L$ )	60 – 150 seconds
Peak Temperature ( $T_p$ )		260 <sup>+0/-5</sup> °C
Time within 5°C of actual peak Temperature ( $t_p$ )		20 – 40 seconds
Ramp-down Rate		5°C/second max
Time 25°C to peak Temperature ( $T_p$ )		8 minutes Max.
Do not exceed		280°C



### Physical Specifications

<b>Terminal Finish</b>	100% Matte Tin-plated
<b>Body Material</b>	UL recognized epoxy meeting flammability classification 94V-0
<b>Lead Material</b>	Copper Alloy

### Design Considerations

Careful selection of the correct device for the application's operating parameters and environment will go a long way toward extending the operating life of the Thyristor. Good design practice should limit the maximum continuous current through the main terminals to 75% of the device rating. Other ways to ensure long life for a power discrete semiconductor are proper heat sinking and selection of voltage ratings for worst case conditions. Overheating, overvoltage (including dv/dt), and surge currents are the main killers of semiconductors. Correct mounting, soldering, and forming of the leads also help protect against component damage.

### Environmental Specifications

Test	Specifications and Conditions
<b>High Temperature Voltage Blocking</b>	MIL-STD-750: Method 1040, Condition A Rated $V_{BRM}$ , 125°C, 1008 hours
<b>Temperature Cycling</b>	MIL-STD-750: Method 1051 -40°C to 125°C, 15-minute dwell, 100 cycles
<b>Biased Temp &amp; Humidity</b>	EIA/JEDEC: JESD22-A101 320VDC, 85°C, 85%RH, 1008 hours
<b>High Temp. Storage</b>	MIL-STD-750: Method 1031 150°C, 1008 hours
<b>Low-Temp Storage</b>	-40°C, 1008 hours
<b>Thermal Shock</b>	MIL-STD-750: Method 1056 0°C to 100°C, 5-minute dwell, 10-second transfer, 10 cycles
<b>Autoclave (Pressure Cooker Test)</b>	EIA/JEDEC: JESD22-A102 121°C, 100%RH, 2atm, 168 hours
<b>Resistance to Solder Heat</b>	MIL-STD-750: Method 2031 260°C, 10 seconds
<b>Solderability</b>	ANSI/J-STD-002, Category 3, Test A
<b>Lead Bend</b>	MIL-STD-750: Method 2036, Condition E

**Dimensions — TO-220AB (R Package) — Non-isolated Mounting Tab**



Note: Maximum torque to be applied to mounting tab is 8 in-lbs. (0.904 Nm).

Dimension	Inches		Millimeters	
	Min	Max	Min	Max
A	0.380	0.420	9.65	10.67
B	0.105	0.115	2.67	2.92
C	0.230	0.250	5.84	6.35
D	0.590	0.620	14.99	15.75
E	0.142	0.147	3.61	3.73
F	0.110	0.130	2.79	3.30
G	0.540	0.575	13.72	14.61
H	0.025	0.035	0.64	0.89
J	0.195	0.205	4.95	5.21
K	0.095	0.105	2.41	2.67
L	0.060	0.075	1.52	1.91
M	0.085	0.095	2.16	2.41
N	0.018	0.024	0.46	0.61
O	0.178	0.188	4.52	4.78
P	0.045	0.060	1.14	1.52
R	0.038	0.048	0.97	1.22

**Dimensions — TO-220AB (L Package) — Isolated Mounting Tab**



Note: Maximum torque to be applied to mounting tab is 8 in-lbs. (0.904 Nm).

Dimension	Inches		Millimeters	
	Min	Max	Min	Max
A	0.380	0.420	9.65	10.67
B	0.105	0.115	2.66	2.92
C	0.230	0.250	5.85	6.35
D	0.590	0.620	14.98	15.75
E	0.142	0.147	3.61	3.73
F	0.110	0.130	2.80	3.30
G	0.540	0.575	13.71	14.60
H	0.025	0.035	0.63	0.89
J	0.195	0.205	4.95	5.21
K	0.095	0.105	2.41	2.67
L	0.060	0.075	1.52	1.91
M	0.085	0.095	1.78	2.16
N	0.018	0.024	0.45	0.61
O	0.178	0.188	4.52	4.78
P	0.045	0.060	1.14	1.53
R	0.038	0.048	0.97	1.22

## Dimensions — TO-263 (N Package) — D<sup>2</sup>Pak Surface Mount



Dimension	Inches		Millimeters	
	Min	Max	Min	Max
A	0.360	0.370	9.14	9.40
B	0.380	0.420	9.65	10.67
C	0.178	0.188	4.52	4.78
D	0.025	0.035	0.64	0.89
E	0.045	0.060	1.14	1.52
F	0.060	0.075	1.52	1.91
G	0.095	0.105	2.41	2.67
H	0.092	0.102	2.34	2.59
J	0.018	0.024	0.46	0.61
K	0.090	0.110	2.29	2.79
S	0.590	0.625	14.99	15.88
V	0.035	0.045	0.89	1.14
U	0.002	0.010	0.05	0.25
W	0.040	0.070	1.02	1.78

## Dimensions — TO-218AC (K Package) — Isolated Mounting Tab



Dimension	Inches		Millimeters	
	Min	Max	Min	Max
A	0.810	0.835	20.57	21.21
B	0.610	0.630	15.49	16.00
C	0.178	0.188	4.52	4.78
D	0.055	0.070	1.40	1.78
E	0.487	0.497	12.37	12.62
F	0.635	0.655	16.13	16.64
G	0.022	0.029	0.56	0.74
H	0.075	0.095	1.91	2.41
J	0.575	0.625	14.61	15.88
K	0.211	0.219	5.36	5.56
L	0.422	0.437	10.72	11.10
M	0.058	0.068	1.47	1.73
N	0.045	0.055	1.14	1.40
P	0.095	0.115	2.41	2.92
Q	0.008	0.016	0.20	0.41
R	0.008	0.016	0.20	0.41
U	0.164	0.165	4.10	4.20
W	0.085	0.095	2.17	2.42



## Dimensions — TO-218X (J Package) — Isolated Mounting Tab

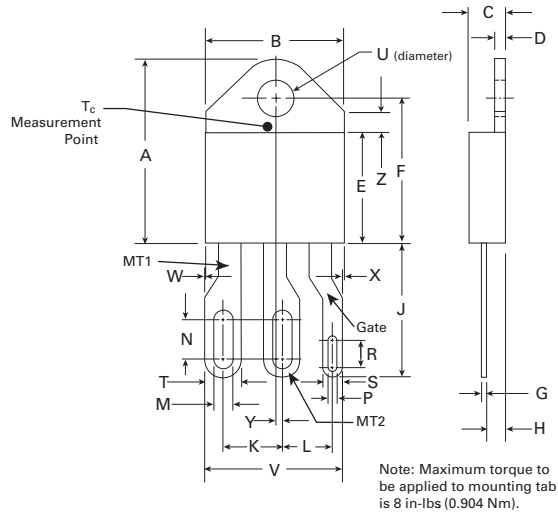

Dimension	Inches		Millimeters	
	Min	Max	Min	Max
A	0.810	0.835	20.57	21.21
B	0.610	0.630	15.49	16.00
C	0.178	0.188	4.52	4.78
D	0.055	0.070	1.40	1.78
E	0.487	0.497	12.37	12.62
F	0.635	0.655	16.13	16.64
G	0.022	0.029	0.56	0.74
H	0.075	0.095	1.91	2.41
J	0.575	0.625	14.61	15.88
K	0.256	0.264	6.50	6.71
L	0.220	0.228	5.58	5.79
M	0.080	0.088	2.03	2.24
N	0.169	0.177	4.29	4.49
P	0.034	0.042	0.86	1.07
R	0.113	0.121	2.87	3.07
S	0.086	0.096	2.18	2.44
T	0.156	0.166	3.96	4.22
U	0.164	0.165	0.410	0.420
V	0.603	0.618	15.31	15.70
W	0.000	0.005	0.00	0.13
X	0.003	0.012	0.07	0.30
Y	0.028	0.032	0.71	0.81
Z	0.085	0.095	2.17	2.42

## Dimensions — TO-3 (P Package) Fastpak — Isolated Mounting Tab

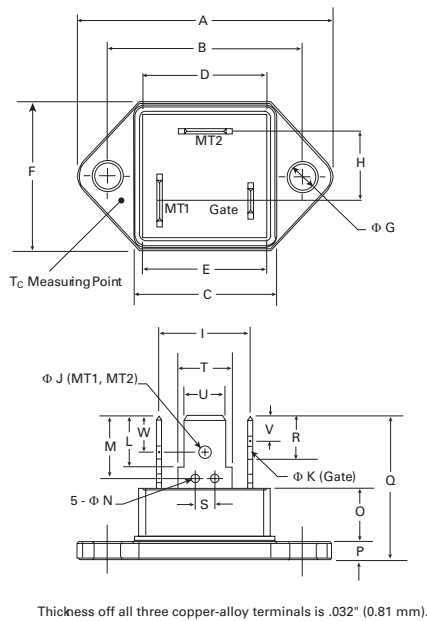

Dimension	Inches		Millimeters	
	Min	Max	Min	Max
A	1.531	1.543	38.90	39.20
B	1.177	1.185	29.90	30.10
C	0.843	0.850	21.40	21.60
D	0.780	0.795	19.80	20.20
E	0.783	0.791	19.90	20.10
F	0.874	0.906	22.20	23.00
G	0.161	0.169	4.10	4.30
H	0.386	0.465	9.80	11.80
I	0.508	0.587	12.90	14.90
J	0.079	0.087	2.00	2.20
K	0.047	0.055	1.20	1.40
L	0.307	0.319	7.80	8.10
M	0.372	0.396	9.45	10.05
N	0.043	0.059	1.10	1.50
O	0.315	0.331	8.00	8.40
P	0.098	0.106	2.50	2.70
Q	0.846	0.886	21.50	22.50
R	0.244	0.256	6.20	6.50
S	0.106	0.130	2.70	3.30
T (MT1)	0.321	0.329	8.15	8.35
T (MT2)	0.321	0.329	8.15	8.35
T (Gate)	0.220	0.228	5.60	5.80
U (MT1)	0.246	0.254	6.25	6.45
U (MT2)	0.246	0.254	6.25	6.45
U (Gate)	0.183	0.191	4.65	4.85
V	0.120	0.130	3.05	3.30
W	0.175	0.185	4.45	4.70

Maximum torque to be applied to mounting tab is 8 in-lbs (0.904Nm).

### Product Selector

Part Number	Voltage				Gate Sensitivity Quadrants		Package
	400V	600V	800V	1000V	I - II - III	IV	
Qxx25R5	X	X	X	X	50 mA	120 mA (TYP)	TO-220R
Qxx25N5	X	X	X	X	50 mA	120 mA (TYP)	TO-263 D <sup>2</sup> -Pak
Qxx25P5		X	X		50 mA	120 mA (TYP)	Fastpak
Qxx25RH5	X	X	X		50 mA		TO-220R
Qxx25LH5	X	X	X		50 mA		TO-220L
Qxx25NH5	X	X	X		50 mA		TO-263 D <sup>2</sup> -Pak
Qxx25R6	X	X	X	X	80 mA		TO-220R
Qxx25L6	X	X	X	X	80 mA		TO-220L
Qxx25NH6	X	X	X	X	80 mA		TO-263 D <sup>2</sup> -Pak
Qxx25J6	X	X	X		80 mA		TO-218X
Qxx25K6	X	X	X	X	80 mA		TO-218AC

### Packing Options

Part Number	Marking	Weight	Packing Mode	Base Quantity
Qxx25R5	Qxx25R5	2.20g	Bulk	500
Qxx25R5TP	Qxx25R5	2.20g	Tube	500 (50 per tube)
Qxx25N5TP	Qxx25N5	1.60g	Tube	500 (50 per tube)
Qxx25N5RP	Qxx25N5	1.60g	Embossed Carrier	500
Qxx25RH5	Qxx25RH5	2.20g	Bulk	500
Qxx25RH5TP	Qxx25RH5	2.20g	Tube	500 (50 per tube)
Qxx25LH5	Qxx25LH5	2.20g	Bulk	500
Qxx25LH5TP	Qxx25LH5	2.20g	Tube	500 (50 per tube)
Qxx25NH5TP	Qxx25NH5	1.60g	Tube	500 (50 per tube)
Qxx25NH5RP	Qxx25NH5	1.60g	Embossed Carrier	500
Qxx25P5	Qxx25P5	21.4g	Bulk	200
Qxx25R6	Qxx25R6	2.20g	Bulk	500
Qxx25R6TP	Qxx25R6	2.20g	Tube	500 (50 per tube)
Qxx25L6	Qxx25L6	2.20g	Bulk	500
Qxx25L6TP	Qxx25L6	2.20g	Tube	500 (50 per tube)
Qxx25NH6TP	Qxx25NH6	1.60g	Tube	500 (50 per tube)
Qxx25NH6RP	Qxx25NH6	1.60g	Embossed Carrier	500
Qxx25J6TP	Qxx25J6	5.23g	Tube	250 (25 per tube)
Qxx25K6TP	Qxx25K6	4.40g	Tube	250 (25 per tube)

**TO-263 Embossed Carrier Reel Pack (RP) Specifications**

Meets all EIA-481-2 Standards



**Part Numbering System**

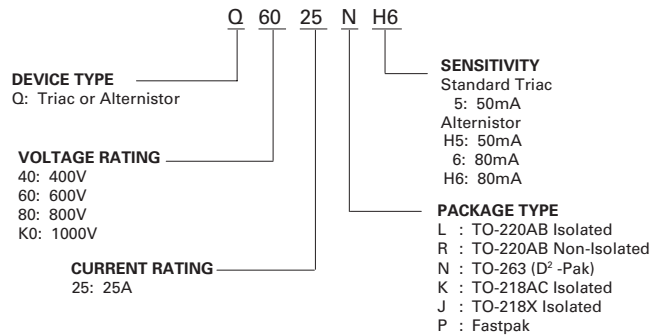

**Part Marking System**

TO-220 AB – (R Package)  
TO-263 AB – (N Package)



TO-218AC (K Package)  
TO-218X (J Package)

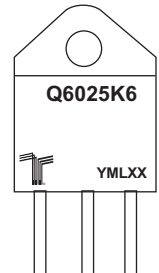

TO-220 AB – (L Package)

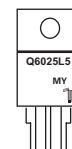

Fastpak (P Package)

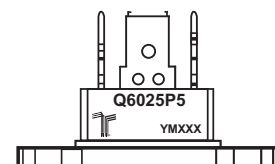

## Данный компонент на территории Российской Федерации

### Вы можете приобрести в компании MosChip.

Для оперативного оформления запроса Вам необходимо перейти по данной ссылке:

<http://moschip.ru/get-element>

Вы можете разместить у нас заказ для любого Вашего проекта, будь то серийное производство или разработка единичного прибора.

В нашем ассортименте представлены ведущие мировые производители активных и пассивных электронных компонентов.

Нашей специализацией является поставка электронной компонентной базы двойного назначения, продукции таких производителей как XILINX, Intel (ex.ALTERA), Vicor, Microchip, Texas Instruments, Analog Devices, Mini-Circuits, Amphenol, Glenair.

Сотрудничество с глобальными дистрибьюторами электронных компонентов, предоставляет возможность заказывать и получать с международных складов практически любой перечень компонентов в оптимальные для Вас сроки.

На всех этапах разработки и производства наши партнеры могут получить квалифицированную поддержку опытных инженеров.

Система менеджмента качества компании отвечает требованиям в соответствии с ГОСТ Р ИСО 9001, ГОСТ РВ 0015-002 и ЭС РД 009

### Офис по работе с юридическими лицами:

105318, г.Москва, ул.Щербаковская д.3, офис 1107, 1118, ДЦ «Щербаковский»

Телефон: +7 495 668-12-70 (многоканальный)

Факс: +7 495 668-12-70 (доб.304)

E-mail: [info@moschip.ru](mailto:info@moschip.ru)

Skype отдела продаж:

moschip.ru

moschip.ru\_4

moschip.ru\_6

moschip.ru\_9