

GENERAL DETAILS OF TYPE Q TIMERS

Q series timers are compact, low cost, precision devices designed to the most demanding specifications. The small size, epoxy filled case is highly resistant against dust, vibrations, shock and humidity. Creep and strike distance according to VDE 0110 Group C 250V. Case protection IP66. Case material - Phenolic.

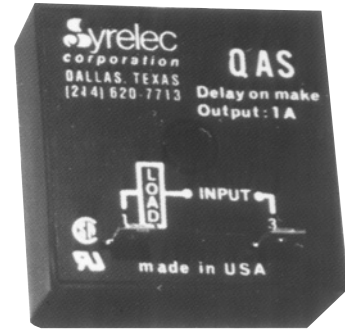

2

QAS SERIES DELAY ON MAKE ELECTRONIC TIMER

UL listed CSA recognized

SPECIFICATIONS:

- Input Power** 24 VAC/DC, 110 VAC/DC
220 VAC/DC $\pm 15\%$, 50/60 Hz
- Output Rating** max.: 1.0 A at 20°C
min.: 10 mA
- Voltage drop after timing** 3.5 VAC/DC
- Repetition accuracy** $\pm 0.5\%$ at a constant ambient
- Temp rise derating** 5 mA / °C
- Reset time SAS & SAS-D** 25 ms after timing
50 ms during timing
- Leakage current during timing** .. 5 mA max
- Peak surge current** 20 A < 10 ms
- Peak surge voltage** 1400 V, 10 μ s
- Terminals** 1/4" (6.35mm) quick connect
- Operating temperature** -22°F to +140°F (-30°C to +60°C)
- Weight** 1.9 oz. (55g)

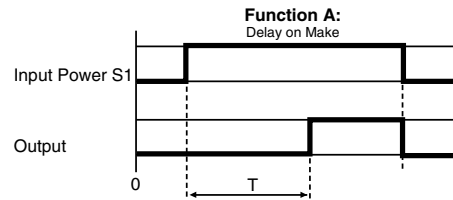

Function A: When input power is applied, timing (t) begins. At the end of the preselected time, the solid state SCR output turns on. The output turns off when the input power is removed, resetting the timer for the next cycle.

WIRING DIAGRAM:



Note: Available with internal potentiometer in AS-P Series

ORDERING INFORMATION: (100 pcs. minimum)

P.S.: Specify maximum time for "D" and "P" version.

Q
MOUNTING

AS-D
SERIES

100S
TIME RANGE

220 AD
INPUT POWER

L
UL

Q = Encapsulated

AS = fixed time
AS-D = remote potentiometer
AS-P = internal potentiometer

AS = Fixed .1 sec - 120 min
AS-D = .1 sec - 60 min. 10:1 Ratio
AS-P = .1 sec - 10 sec
1-100 sec maintain 100:1 ratio

24AD = 24 VAC/DC
110AD = 110 VAC/DC
220AD = 220 VAC/DC

1 AMP

Products and specifications subject to change without notice.

Order/Technical Support – Tel: (800) 677-5311 / FAX: (800) 677-3865 / www.crouzet-usa.com

QBS SERIES SINGLE SHOT TIMER

QCS SERIES DELAY ON BREAK TIMER

UL listed CSA recognized

- CMOS Technology
- Epoxy Encapsulated
- 2" x 2" Compact Size
- .250" Quick Connect Terminals

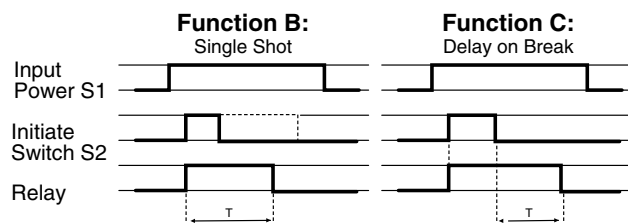
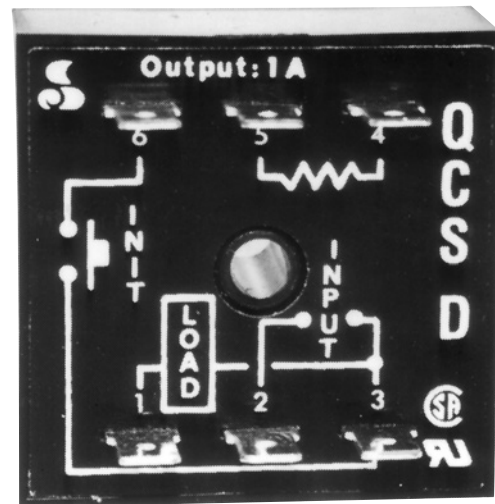

Function B: Input power (S1) is continuously supplied to the timer. When an external initiate switch (S2) is closed, momentarily or maintained, the output relay is energized. At the end of the delay time (T), the output is de-energized. The timer is ready for another cycle. Isolate the initiate switch (S2) from other circuits.

Function C: Input power (S1) is continuously supplied to the timer. When an external initiate switch (S2) is closed, the output relay is energized. Timing begins when the S2 switch opens. At the end of the delay time (T), the output is de-energized and the timer is ready for another cycle. Isolate the initiate switch (S2) from other circuits.

SPECIFICATIONS:

Input	24 VAC, 48 VAC, 110 VAC 220 VAC, ±15%, 50/60 Hz
Maximum power consumption	24 VAC: 0.2 VA 48 VAC: 0.3 VA 110 VAC: 0.6 VA 220 VAC: 1.2 VA
Output	SCR
Output Rating	max.: 1A at 20°C min.: 10 mA
Voltage drop after timing	3.5 V max. AC
Repetition accuracy	±0.5% at a constant ambient
Temp. rise derating	5 mA / °C
Reset time	80 ms
Minimum contact closure	100 ms during timing
Leakage current during timing	5 mA max.
Peak surge current	20 A < 10 ms
Peak surge voltage	1400 V, 100 μs
Terminals	1/4" (6.35) quick connect
Operating temperature	-22°F to +140°F -30°C to +60°C
Weight	1.9 oz. (55g)

The initiate switch should be isolated from the other circuits. Contact will operate on the same supply as the timer and will have a max. load of 5 mA.

The remote potentiometer for the QCS-D and QBS-D should be 470 kΩ, 1/4 W. Use with shielded cable at a maximum length of 50 feet.

ORDERING INFORMATION: (100 pcs. minimum)

Q
MOUNTING

CS
SERIES

B
TIME RANGE

110A
INPUT POWER

L
UL

Q = Encapsulated

CS = Fixed time
 BS = Fixed time
 CS-D = Remote potentiometer
 BS-D = Remote potentiometer
 CS-P = Internal potentiometer
 BS-P = Internal potentiometer

CS/BS = Fixed time
 CS-D = .06 sec. - 120 min
 BS-D = .06 sec. - 120 min. maintain 10:1 ratio
 B or CSP = .1 - 10 sec. or min
 1 - 100 sec. or min. maintain 100:1 ratio

24A = 24 VAC
 48A = 48 VAC
 110A = 110 VAC
 220A = 220 VAC

1 AMP

WIRING DIAGRAM:

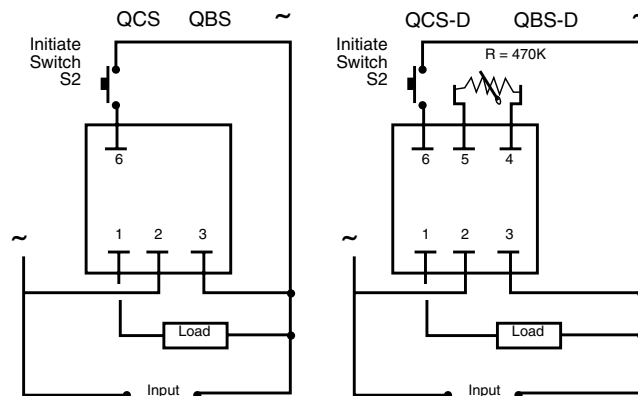

NOTE: Available with internal potentiometer in B or CS-P Series.

DIMENSIONS See page 4-34

Products and specifications subject to change without notice.

QDS SERIES

REPEAT CYCLE

QHS SERIES

INTERVAL ELECTRONIC TIMER

UL listed CSA recognized

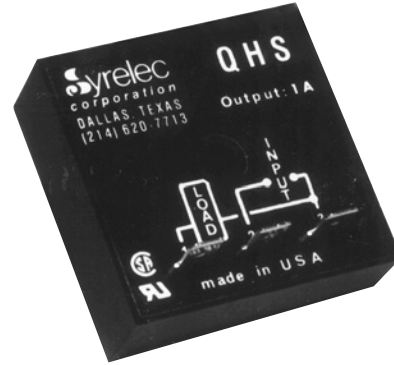

- **Consistent Repeat Cycle**
- **Multiple Voltage**
- **2" Square Cases**
- **Fixed and Variable Time Ranges**

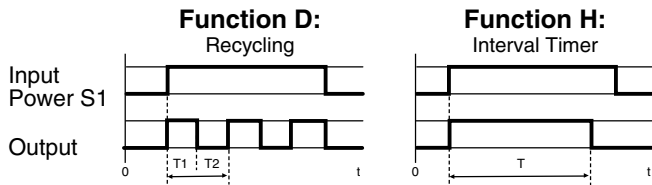

Function H: The solid state output turns on when the input power (S1) is applied. The output turns off at the end of time (T). The timer is reset when the input power is removed.

Function D: When input power (S1) is applied, the solid state output turns on immediately for the time period specified. It then turns OFF for that same time period and repeats continuously while power is applied.

SPECIFICATIONS:

Input	24 VAC, 48 VAC, 110 VAC 220 VAC, ±15%, 50/60 Hz
Maximum power consumption	24 VAC: 0.2 VA 48 VAC: 0.3 VA 110 VAC: 0.6 VA 220 VAC: 1.2 VA
Output	SCR
Output Rating	max.: 1 A at 20°C min.: 10 mA
Voltage drop after timing	3.5 VAC
Repetition accuracy	±0.5% at a constant ambient
Temp. rise derating	5 mA / °C
Reset time	100 ms after timing 150 ms during timing
Minimum contact closure	100 ms during timing
Leakage current during timing	2 mA max.
Peak surge current	20 A < 10 ms
Peak surge voltage	1400 V, 100 μs
Terminals	Faston 1/4" (6.35)
Operating temperature	-22°F to +140°F -30°C to +60°C
Weight	1.9 oz. (55g)

WIRING DIAGRAM:



NOTE: Available with internal potentiometer in HS-P Series.

DIMENSIONS See page 4-34

ORDERING INFORMATION: (100 pcs. minimum)

Q MOUNTING	DS SERIES	10 min TIME RANGE	24A INPUT POWER	L UL
Q = Encapsulated	DS = Fixed time DS-D = Remote potentiometer HS = Fixed time HS-D = Remote potentiometer DS-P = Internal potentiometer HS-P = Internal potentiometer	DS/HS = Fixed .1s - 120 min. DS-D/HS-D = .1 sec - 120 min. maintaining 10:1 ratio DS-P/HS-P = .1-10 sec or min 1-100 sec. or min. maintain 100:1 ratio	24A = 24 VAC 48A = 48 VAC 110A = 110 VAC 220A = 220 VAC	1 AMP

Products and specifications subject to change without notice.

Order/Technical Support – Tel: (800) 677-5311 / FAX: (800) 677-3865 / www.crouzet-usa.com

Данный компонент на территории Российской Федерации

Вы можете приобрести в компании MosChip.

Для оперативного оформления запроса Вам необходимо перейти по данной ссылке:

<http://moschip.ru/get-element>

Вы можете разместить у нас заказ для любого Вашего проекта, будь то серийное производство или разработка единичного прибора.

В нашем ассортименте представлены ведущие мировые производители активных и пассивных электронных компонентов.

Нашей специализацией является поставка электронной компонентной базы двойного назначения, продукции таких производителей как XILINX, Intel (ex.ALTERA), Vicor, Microchip, Texas Instruments, Analog Devices, Mini-Circuits, Amphenol, Glenair.

Сотрудничество с глобальными дистрибьюторами электронных компонентов, предоставляет возможность заказывать и получать с международных складов практически любой перечень компонентов в оптимальные для Вас сроки.

На всех этапах разработки и производства наши партнеры могут получить квалифицированную поддержку опытных инженеров.

Система менеджмента качества компании отвечает требованиям в соответствии с ГОСТ Р ИСО 9001, ГОСТ РВ 0015-002 и ЭС РД 009

Офис по работе с юридическими лицами:

105318, г.Москва, ул.Щербаковская д.3, офис 1107, 1118, ДЦ «Щербаковский»

Телефон: +7 495 668-12-70 (многоканальный)

Факс: +7 495 668-12-70 (доб.304)

E-mail: info@moschip.ru

Skype отдела продаж:

moschip.ru

moschip.ru_4

moschip.ru_6

moschip.ru_9