



## TARGET APPLICATIONS

### Repeaters:

#### PCI Express® Gen 2 Applications

- Blade servers
- Storage systems
- Cabled PCIe devices
- Notebooks & Docking stations
- Mux, Demux, and Switch

#### USB 3.0 Applications

- Workstations & Desktops
- Notebooks & Docking stations
- Peripheral USB devices

#### SAS/SATA Applications

- Servers & Workstations
- Notebooks & Docking stations
- External SATA storage drives
- SAS port expanders

#### Serial RapidIO® Applications

- ATCA blades
- Wireless systems
- Military VITA-41 & VPX systems

#### XAUI Applications

- Routers & Switches
- ATCA blades
- PON access systems
- Blade servers

#### Other Applications

- Common public radio interface (CPRI)
- Open base station architecture (OBSAI)
- Infiniband

### Retimers

#### PCI Express® Gen 3 Applications

- Computing
- Storage
- Communications
- Consumer electronics

### For help or more information:

Hotline: (408) 284 8208  
email: siphelp@idt.com

With the increase of signal speeds in the computing, storage and communications applications, system designers face greater signal integrity challenges. The Signal Integrity Product (SIP) portfolio from Integrated Device Technology provides signal conditioning devices for popular multi-gigabit per second IO protocols delivering signal quality over extended distances while offering simplified design by alleviating board layout constraints.



Figure 1: Typical Signal Deterioration Over Long Channels

### Signal Integrity Challenge

High speed signals can deteriorate to unacceptable levels by the time they reach end receivers, due to transmitter, receiver, and channel characteristics (see figure above).

### IDT Repeaters and Retimers Resolve Signal Integrity Challenges

IDT's Family of Repeaters and Retimers is specifically designed to resolve the issue shown in the above figure and to ensure minimized jitter and maximized eye opening at the target receiver by compensating for cable and PCB trace attenuation and ISI jitter. This is accomplished by boosting the transmitted signal, by equalizing the received signal, or by doing both when either option by itself is not sufficient due to channel length or due to discontinuities generated by vias and connectors. In addition, IDT Retimers minimize random jitter, further increasing signal quality.

### IDT Repeaters

The IDT SIP family of repeater devices include support for: 5Gbps PCI Express® (PCIe) Gen2, USB 3.0, 6Gbps SAS/SATA; 6.25Gbps Serial RapidIO® 2.1, and other standards for computing, storage and communications applications.

SIP devices incorporate advanced receive equalization and transmit de-emphasis capabilities, as

well as diagnostic features that help IDT customers achieve a simplified design with faster time-to-market. Specifically, the devices drive long on-board traces, backplane traces and cables to external devices to ensure optimum system performance. In addition, they include loss of signal (LOS) detection and individual channel loopback diagnostic capabilities as well as 2:1 mux/demux functions. Devices support 2, 4, or 8 differential channels, configurable via I<sup>2</sup>C, control pins, or EEPROM. The devices offer power-saving modes for the lowest possible power consumption.

### IDT Retimers

The IDT Retimer devices are the industry's first signal-conditioning parts fully compliant with the PCIe 3.0 specification. They are compliant to the PCIe Automatic Link Equalization procedure, easing system design and enhancing reliability with any PCIe-compliant expansion card or host bus adapter. IDT Retimers are designed to improve signal integrity and to more than double maximum PCB trace and cable lengths. These devices minimize both random and deterministic jitter from the input signal before transmitting it out to target devices.

IDT Repeaters and Retimers are ideal for solving signal integrity problems in blade servers, enterprise storage, communication systems, and cloud computing.

# REPEATERS

## REPEATER FEATURES

- Compensates for cable and PCB trace attenuation and ISI jitter
- Programmable receiver equalization up to 30db
- Programmable de-emphasis up to -8.5dB
- Recovers data stream even when the differential signal eye is completely closed due to trace attenuation and ISI jitter
- Full PCIe protocol support
- SAS/SATA, Out of Board (OOB) Support
- Configurable via external pins, while extended programming ranges are available via I<sup>2</sup>C interface

- Supports automatic download of configuration from external EEPROM with a single or multiple repeaters on I<sup>2</sup>C bus
- Power minimization in active and shutdown modes
- No external bias resistors or reference clocks required
- Channel mux mode, demux mode, 1 to 2 channels multicast, and Z-switch function mode

## REPEATER BENEFITS

- Extends maximum cable length to over 10 meters and trace length over 65 inches in PCIe applications
- Speeds up system design time by allowing usage of longer trace and cable lengths
- Minimizes BER

## PCIe APPLICATIONS — REPEATERS

### Blade Servers

Blade servers inherently require the use of long interconnects and multiple connectors to transfer signals between blades. IDT PCIe Repeaters can be used to transmit boosted signals into backplanes and to recover from long trace-related and connector-related signal attenuations and jitter at the receiving end. See Figure 2.



Figure 2: Blade Server Application

### Storage

Similar to blade server applications, Storage Area Networks (SAN) face a challenge of transferring reliable PCIe signals between redundant storage processors. IDT PCIe Repeaters can boost transmitted signals and restore noisy and attenuated signals at the receiving end. See Figure 3.



Figure 3: Storage Application

### Cabled PCIe Systems

There are various system applications using cables to transmit PCIe signals between chassis (see Figure 4). Networking and storage equipment, medical instrumentation, data acquisition systems such as scopes and protocol analyzers, and peripheral devices are just a few examples of PCIe cabled systems. IDT Repeaters permit the use of less expensive and longer cables, allowing for significant savings and improving distance constraints. Expensive PCIe cables can be replaced with less expensive ones for a significant savings. See Figure 4.



Figure 4: Cabled PCIe Application

### Notebooks and Docking Stations

PCIe connectors available in docking stations need to pass the compliance test. This is a chal-

lenging test, since a signal's quality degrades as it passes from the chipset inside the notebook, through traces and connectors. IDT Repeaters can be used at the PCIe connector inside the docking station to resolve this issue. See Figure 5.

## Mux, Demux, and Switch Applications

IDT PCIe Repeaters permit a variety of muxing (2 links to 1 link), demuxing (1 link to 2 links), and switching configurations (2 links to 2 links) supporting long traces and cables (see Figure 6). Detailed information on all these configurations can be found in the "Channel muxing" sections of IDT PCIe Repeater data sheets.

## USB 3.0 APPLICATIONS — REPEATERS

### Workstations and Desktops

Workstations and desktops, due to their size, inherently require the use of long interconnects to transfer signals from internal boards to front and back panel USB ports. Each USB 3.0 port needs to pass the compliance test. This can be a challenging test, since a signal's quality degrades as it passes from the USB 3.0 controller, through traces, cables, and connectors, to the USB ports. To resolve this issue, IDT USB Repeaters can be used at both back panel and front panel USB 3.0 ports to restore the signals at the ports and prevent compliance test issues. See Figure 7.

### Notebooks and Docking Stations

Docking stations using USB 3.0 connectors need to pass USB compliance, which is measured at a USB 3.0 port. This is a challenging test, since a signal's quality degrades as it passes from the chip set (Figure 8) or USB 3.0 controller (Figure 9) inside the notebook, through traces and connector on its path, to a USB 3.0 port. IDT USB Repeaters can be used at the USB 3.0 port inside the docking station to boost the signal at the port, thereby resolving the degradation issue.

### Peripheral USB 3.0 Devices

In cases where peripheral USB devices, such as hard disk drives, solid state drives, printers, and wireless routers, are placed at a significant distance from the USB host system (desktop, notebook, workstation, etc.), the signals transmitted across long cables might be degraded to the point of being unrecoverable at the receiving end. With signal pre-conditioning, IDT USB Repeaters reduce the effect of degradation and enable the



Figure 5: Notebook Application

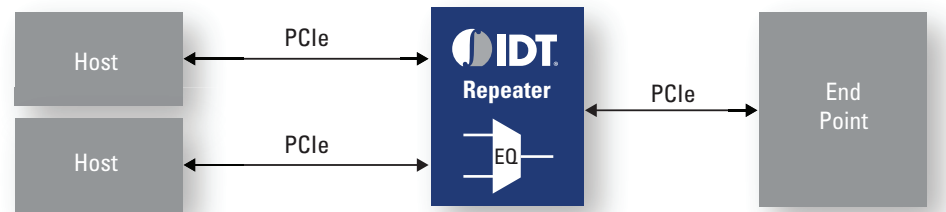

Figure 6: Mux / Demux Application



Figure 7: Workstation and Desktop Application

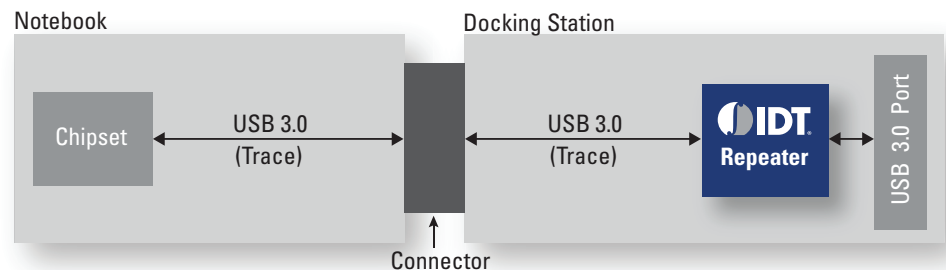

Figure 8: Notebook Application with Chipset Containing USB 3.0 Controller

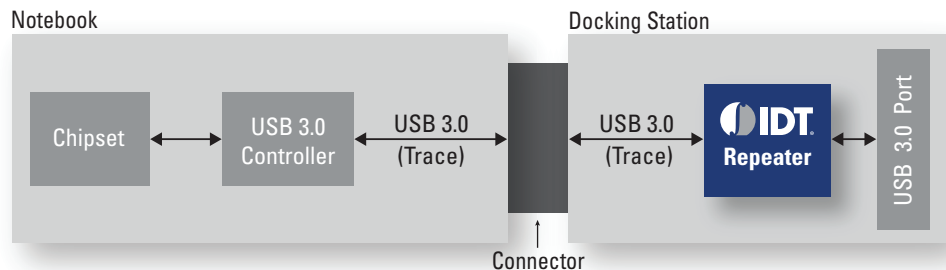

Figure 9: Notebook Application with USB 3.0 Controller Not Included in Chipset

use of very long USB 3.0 cables. With IDT USB Repeaters, inexpensive and lower quality cables can also be used for cost-sensitive applications.

To ensure successful signal reception at both ends, it is recommended that IDT USB Repeaters be placed near the USB 3.0 ports inside the host and peripheral device. See Figure 10.

### SAS, SATA APPLICATIONS — REPEATERS

#### Servers and Workstations

In a server, storage drives (HDD or SSD) are plugged directly into a midplane card, which connects to the main system board containing CPUs and HBAs. During the transmission of SAS or SATA signals between CPUs/HBAs and storage drives, signals are significantly degraded as they pass through long traces on system and midplane boards and multiple connectors. IDT SAS/SATA Repeaters can be used to ensure that differential eye opening at the receiver exceeds 6Gbps SAS and SATA receiver standard specifications. The figures below depict the use of IDT repeaters in 6Gbps SATA-based data transfers (Figure 11) and in 6Gbps SAS-based applications (Figure 12).

#### Notebooks and Docking Stations

Notebooks and Docking Stations using eSATA connectors for peripheral storage devices need to pass SAS/SATA compliance, which is measured at 6Gbps SAS or SATA port. This is a challenging test, since the signal's quality degrades as it passes from the SATA/eSATA adapter card, through traces and connectors on its path, before reaching the 6Gbps eSATA port. IDT SAS/SATA Repeaters can be used at the 6Gbps SAS or SATA port inside the docking station to restore signal quality at the port and prevent compliance failure issues. See Figure 13.

#### External SATA Storage Hard Drives and Solid State Drives

In cases where peripheral SATA storage devices, such as hard disk drives or solid state drives, are placed a significant distance away from the SATA host system (desktop, notebook, workstation, etc.), the signal transmitted across long cables might be degraded to the point of being unrecoverable at the receiving end. IDT SAS/SATA Repeaters resolve this issue and enable the use of very long 6Gbps SAS/SATA cables. With IDT SAS/SATA Repeaters, inexpensive and lower quality cables can also be used.



Figure 10: Application with Peripheral USB 3.0 Devices



Figure 11: Server Application with Chipset Containing 6Gbps SATA Controller



Figure 12: Server Application with 6Gbps SAS Controller



Figure 13: Notebook and Docking Station Application

To ensure successful signal reception at both ends, it is recommended that IDT SAS/SATA Repeaters be placed near the 6Gbps SAS or SATA ports inside the host and peripheral device. See Figure 14.

## SAS Port Expanders

One of the important features of the 6Gbps SAS protocol is its ability to increase storage capacity via SAS Port Expanders. The standard allows up to 255 expanders, which can translate to Petabytes of total storage within a single system. The host system communicates with the expanders through cables that can be up to 10 meters long. To pass SAS compliance, both host system and port expander SAS ports need to deliver high signal quality so that the transmitted signals, attenuated by long cables, can be correctly received. IDT SAS Repeaters can be used at the 6Gbps SAS port inside the host system and port expanders to boost transmitted signals, to restore the received signals at the port, and assure reliable operation. See Figure 15.

## S-RIO APPLICATIONS — REPEATERS

### ATCA Blades

ATCA blades inherently require the use of long interconnects and multiple connectors to transfer signals between blades. IDT Serial RapidIO Repeaters can be used to transmit boosted signals into backplanes and to recover from long trace-related and connector-related signal attenuations and jitter at the receiving end. See Figure 16.

### Wireless Systems

Carrier grade wireless systems are designed for scalability via (1) backplane-based modular designs or (2) a combination of midplane cards and external expansion cards. In the first case, during the transmission of Serial RapidIO packets between S-RIO cards, signals are significantly degraded as they pass through long trace lines on backplane boards, two connectors, and several vias. IDT S-RIO Repeaters can be used to ensure that differential eye openings at the receiver exceed 6.25Gbps S-RIO receiver standard specifications. Figure 17 depicts the use of IDT repeaters in wireless systems with backplanes

In the second case, the main controller card needs to communicate both with an internal expansion card through midplane card traces and



Figure 14: External SATA Storage Application



Figure 15: Port Expanders Application



Figure 16: ATCA Blade Application



Figure 17: Wireless Systems with Backplanes

with external expansion cards through cables. IDT S-RIO Repeaters can be used to boost signals for trace and cable transmissions and to ensure reliable communication with internal and external expansion cards. See Figure 18.

**Military Open VITA-41 and VPX Systems**

Military Open VPX Systems require transfers of S-RIO packets from a S-RIO payload card to multiple switch cards via backplanes. The transmitted signal must cross 2 connectors, multiple board vias, and traces on host, target, and backplane cards. Due to this connection, the transmitted signal might be degraded to the point of being unrecoverable at the receiving end. IDT S-RIO Repeaters resolve this issue and enable the use of very long 6.25Gbps S-RIO traces.

To ensure successful signal reception at both ends, it is recommended that IDT S-RIO Repeaters be placed near the 6.25Gbps S-RIO connectors inside the host and target switch cards. See Figure 19.

**XAUI APPLICATIONS — REPEATERS**

**Routers and Switches**

In enterprise routers and switches, specialized modules within a chassis system communicate with each other via high speed backplanes. As the 10Gb Ethernet protocol becomes more widely adopted in these systems, backplanes implement XAUI connections required by the protocol. Both modules and backplanes often require long board traces. Signals transmitted between modules accumulate noise, jitter, and attenuations while passing from one module, through backplane and backplane connectors, to another module. IDT XAUI Repeaters can be used to ensure that received signals exceed XAUI receiver specifications. See Figure 20.

**ATCA Blades**

ATCA blades make heavy use of inter-blade data transfers, making it necessary for high speed differential signals to be transmitted over long interconnects and through multiple connectors. IDT XAUI Repeaters can be used to transmit boosted signals into backplanes and to recover from long trace-related and connector-related signal attenuations and jitter at the receiving end. See Figure 21.



Figure 18: Wireless Systems with Expansion Cards

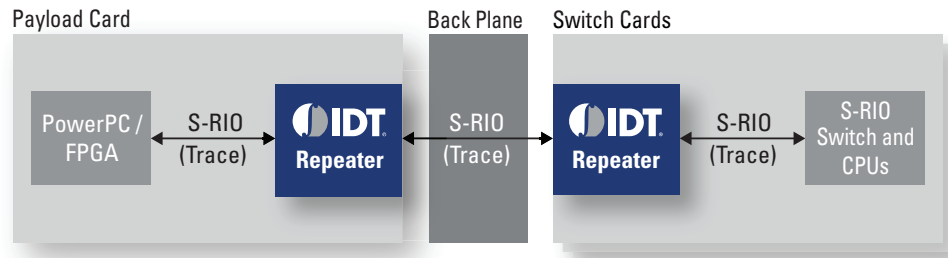

Figure 19: Military Application

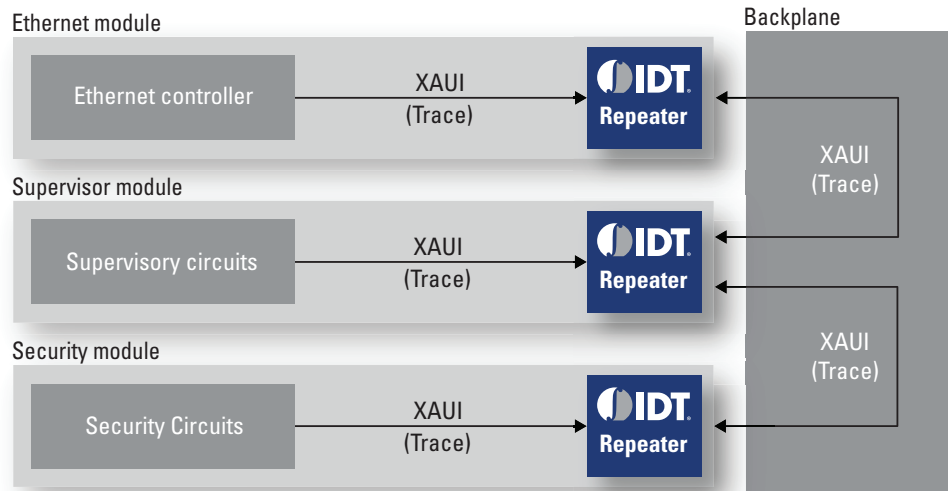

Figure 20: Router or Switches Application

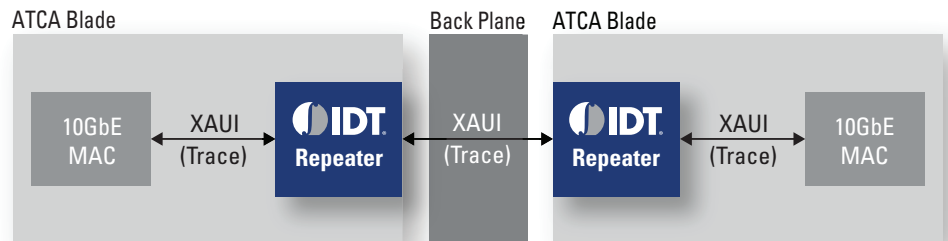

Figure 21: ATCA Application

## PON (Passive Optical Network)

### Access System Application

Similar to ATCA applications, PON access systems face the challenge of transferring reliable XAUI signals across backplane. XAUI signals need to be transferred from a 10GbE (10Gbit Ethernet) MAC located on a line card through card traces, connectors, and a backplane before reaching a 10GbE switch included on the control board. IDT XAUI Repeaters can boost transmitted signals and restore noisy and attenuated signals at the receiving end. See Figure 22.



Figure 22: PON Access System Application

## Blade Servers

Blade servers inherently require the use of long interconnects and multiple connectors to transfer signals between blades. IDT XAUI Repeaters boost transmitted signals, restore noisy and attenuated received signals, and ensure good signal quality at the receiving end. See Figure 23.



Figure 23: Blade Server Application

## OTHER APPLICATIONS — REPEATERS

### CPRI (Common Public Radio Interface)

Public radio transmission stations contain Radio Equipment (RE) with RF front end circuits that need to communicate with Radio Equipment Controllers (REC). The connection between these two systems is typically established via an optical CPRI link. There are different topologies linking one or more REC with one or more RE units: single or multiple point-to-point, ring, tree, and chain. In each case, if the connection lengths between the systems are less than 15 meters, IDT 6.25Gbps Repeaters can be used to enable the use of low cost copper cables in place of expensive optical fiber cables. IDT 6.25Gbps Repeaters placed at cable connectors ensure that received CPRI signals exceed minimum receiver specifications and minimize bit error rates. See Figure 24.

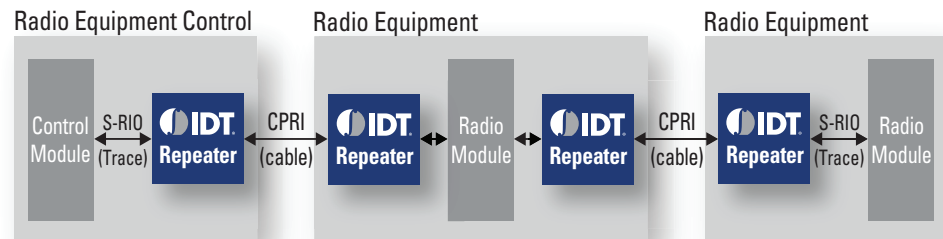

Figure 24: CPRI Application

### OBSAI (Open Base Station Architecture Initiative)

The OBSAI RP3 specification defines the interface between the baseband control module and the Remote Radio Unit (RRU). A single Baseband module can act as a hub to one or more RRUs. In some cases, it is desirable to have RRUs placed several kilometers away from the baseband module. In this scenario, optical cables must be used to connect the systems. In other cases, main control modules reside within 15 meters from RRUs



Figure 25: OBSAI Application

and, similar to short-distance CPRI applications, IDT 6.25Gbps Repeaters can be used in these applications to enable the use of low cost copper cables in place of expensive optical fiber cables. See Figure 25 (previous page).

### Infiniband

In high-performance computing and enterprise data centers, an Infiniband link is a preferred choice with its high throughput, low latency, quality of service, failover, and scalability features. The InfiniBand architecture specification defines a connection between processor nodes and high performance I/O nodes, such as storage devices. The specification allows wide area networks, but Infiniband is mostly used as a local storage area network (SAN). In SAN topology, Infiniband components such as links, channel adaptors, switches, and routers typically transfer Infiniband packets via copper cables. Because Infiniband components might be several meters away from one another, transmitted signals between components may degrade and become unrecoverable. IDT 6.25Gbps Repeaters can be used at Infiniband ports to boost transmitted signals and to restore noisy and attenuated signals at the receiving end, thereby resolving this signal integrity issue. See Figure 26.



Figure 26: Infiniband Storage Area Network (SAN) Application

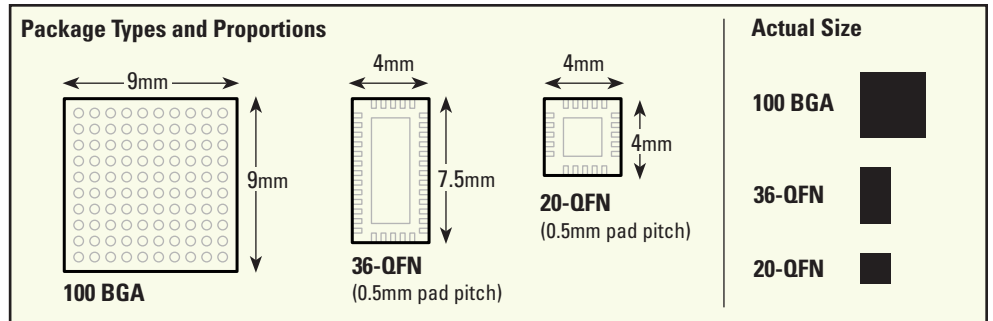

### IDT REPEATER PRODUCT SELECTOR

IDT Part Number *	Protocol	Configurability**	Max Data Rate (Gbps)	Channels	Package
89HP0504P	PCIe Gen 2	Pins and I <sup>2</sup> C	5.0	4	100-BGA, 36-QFN
89HP0504PB	PCIe Gen 2	Pins	5.0	4	36-QFN
89HP0508P	PCIe Gen 2	I <sup>2</sup> C	5.0	8	100-BGA
89HP0504U	USB 3.0	Pins	5.0	4	36-QFN
89HP0504UB	USB 3.0	I <sup>2</sup> C	5.0	4	36-QFN
89HP0604S	SAS/SATA	Pins and I <sup>2</sup> C	6.0	4	100-BGA, 36-QFN
89HP0604SB	SAS/SATA	Pins	6.0	4	36-QFN
89HP0608S	SAS/SATA	I <sup>2</sup> C	6.0	8	100-BGA
89HP0604R	Serial RapidIO	Pins and I <sup>2</sup> C	6.25	4	100-BGA
89HP0608R	Serial RapidIO	I <sup>2</sup> C	6.25	8	100-BGA
89HP0604X	XAUI	Pins and I <sup>2</sup> C	6.25	4	100-BGA
89HP0608X	XAUI	I <sup>2</sup> C	6.25	8	100-BGA
89HP0604Q	Multi	I <sup>2</sup> C	6.25	4	36-QFN
89HP0604QB	Multi	Pins	6.25	4	36-QFN
89HP0602Q	Multi	Pins	6.25	2	20-QFN

\* Part ordering for variations: green or non green package, commercial or industrial range, and tape and reel / bulk. In addition, 100-BGA and 36-QFN package variations are available for 89HP0504P and 89HP0604S parts. Please, refer to last page of datasheets for orderable part numbers

\*\* Use I<sup>2</sup>C for access to the full extended set of configuration options



**RETIMER FEATURES****High Performance**

- Minimizes random input jitter
- Minimizes deterministic ISI jitter
- Compensates for channel attenuations
- Tunable RX and TX performance and power
- Up to 8dB of transmit deemphasis
- Programmable multi-stage equalizer
- CTLE and 5 tap DFE
- Fast acquisition PLL for L0s exit
- On-chip SERDES eye scope

**SerDes Power Savings**

- Supports low swing operation
- Auto low power for unused lanes

**PCIe Standards and Compatibility**

- PCI Express Base Specification 3.0 compliant
- PCI Express Base Specification 2.1 compliant

**Hot Plug Support**

- Link Configurability
- Configurable to 1x8, 1x4, 1x1, 2x4, 2x1
- Automatic per port link width negotiation
- Per-lane SerDes configuration
  - De-emphasis, equalization, drive

**Clocking**

- Standard 100 MHz PCIe reference clock
- SSCLK (Spread Spectrum) and non-SSCLK
- Writing new or initial image into external EEPROM
- Expose internal global CSR space to system controller

**Reliability, Availability and Serviceability**

- Physical layer error checking and accounting
- End-to-end data path parity protection
- Checksum Serial EEPROM content protected

**Test and Debug**

- Per link/lane error diagnostic registers
- All registers accessible from I<sup>2</sup>C or JTAG port
- SerDes test modes
- Several loopback modes

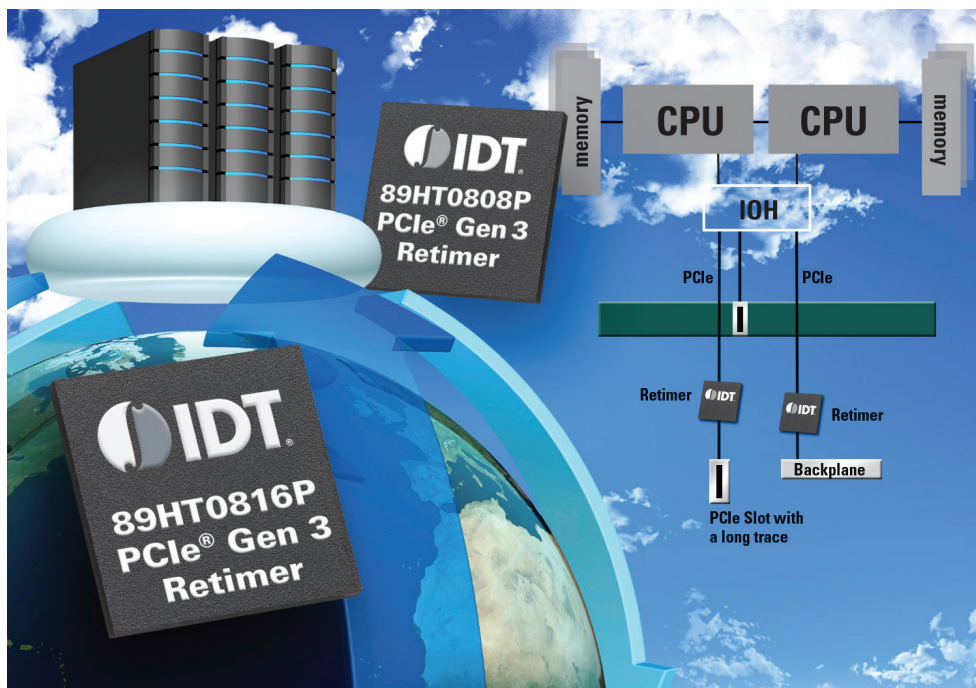
**PCIe Applications — Retimers**

IDT Retimer devices contain a mix of high performance and instrumentation features and include extensive configurability of RX and TX functions. These retimers fully support the automatic equalization procedure, newly defined in the PCIe 3.0 specification. The parts are optimized for power consumption and incorporate high performance features, such as multi-stage equalizer with CTLE and 5 tap DFE, automatic handshake for RX equalization compliant with PCIe Express<sup>®</sup> 3.0, and fast acquisition PLLs for L0 exits.

Test, debug, and optimization features make this part ideal for quick design turnaround time. For example, on-die eye scope with in-field diagnostics is provided for quick in-system optimization of eye characteristics via multiple configuration registers. An evaluation board is also available and is accompanied by a user-friendly graphical user interface (GUI) software utility. The family of Retimers also supports extensive configurability for every feature via an SMBus or I<sup>2</sup>C slave device. Additionally, the configuration data can be downloaded from a serial-EEPROM. Multiple features are provided to minimize power consumption, including Active State Power Management (ASPM) of each link as well as half-swing SerDes mode and automatic power reduction on unused lanes. IDT Retimers, similar to IDT PCIe Repeaters, are ideal for high performance enterprise applications including blade servers, enterprise storage, communication systems, and cloud computing.

## COLLATERAL DOCUMENTATION

### 89HP0504P 4-channel PCIe Gen2 Signal Repeater

89HP0504P Product Brief  
 89HP0504P Data Sheet  
 89HP0504P Device Errata (Revision ZB)  
 89HP0504P Device Errata (Revision ZA)  
 AN-728: IDT Signal Repeater - Managing Board designs  
 Across Silicon revisions "Q", "ZA" and "ZB"

### 89EBP0504P (BGA) Evaluation Board

User Manual  
 89EBP0504P (BGA) Eval Board Schematics  
 (layered for online viewing)  
 89EBP0504P (BGA) Eval Board Schematics  
 (optimized for printing)  
 89EBP0504P (BGA) Eval Board Schematics Cadence Database  
 89EBP0504P (BGA) Eval Board OrCAD Schematics  
 89EBP0504P (QFN) Eval Board Schematics  
 (layered for online viewing)  
 89EBP0504P (QFN) Eval BoardSchematics  
 (optimized for printing)

### 89EBP0504P (QFN) Evaluation Board User Manual

89EBP0504P (QFN) Eval Board Schematics  
 (layered for online viewing)  
 89EBP0504P (QFN) Eval Board Schematics  
 (optimized for printing)

### 89EBP0504PB (QFN) Evaluation Board

User Manual

### 89HP0504PB 4-channel PCIe Gen2 Signal Repeater

89HP0504PB Product Brief  
 89HP0504PB Data Sheet  
 89HP0504PB Device Errata (Revision ZB)

### 89HP0508P 8-channel PCIe Gen2 Signal Repeater

89HP0508P Product Brief  
 89HP0508P Data Sheet  
 89HP0508P Device Errata (Revision ZB)  
 89HP0508P Device Errata (Revision ZA)  
 AN-728: IDT Signal Repeater - Managing Board designs  
 Across Silicon revisions "Q", "ZA" and "ZB"  
 89EBP0508P Eval Board Schematics  
 (layered for online viewing)  
 89EBP0508P Eval Board Schematics (optimized for printing)  
 89EBP0508P Eval Board Schematics Cadence Database  
 89EBP0508P Eval Board Layout Database  
 89EBP0508P Evaluation Board User Manual  
 89EBP0508P Eval Board Schematics  
 (layered for online viewing)  
 89EBP0508P Eval Board Schematics (optimized for printing)  
 89EBP0508P Eval Board Schematics Cadence Database  
 89EBP0508P Eval Board OrCAD Schematics

### 89HP0504U 4-channel USB 3.0 Signal Repeater

89HP0504U Product Brief  
 89HP0504U Data Sheet  
 89HP0504U Device Errata (Revision ZB)  
 89HP0504U Device Errata (Revision ZA)

### 89EBP0504U Evaluation Board

User Manual  
 89EBP0504U Eval Board Schematics  
 (layered for online viewing)  
 89EBP0504U Eval Board Schematics (optimized for printing)

### 89HP0504UB 4-channel USB 3.0 Signal Repeater

89HP0504UB Product Brief  
 89HP0504UB Data Sheet  
 89HP0504UB Device Errata (Revision ZB)

### 89EBP0504UB Evaluation Board

User Manual  
 89EBP0504UB Eval Board Schematics  
 (layered for online viewing)  
 89EBP0504UB Eval Board Schematics (optimized for printing)

### 89HP0604S 4-channel SAS/SATA 6G Signal Repeater

89HP0604S Product Brief  
 89HP0604S Data Sheet  
 89HP0604S Device Errata (Revision ZB)  
 89HP0604S Device Errata (Revision ZA)

### 89EBP0604S Evaluation Board

User Manual  
 89EBP0604S Eval Board Schematics  
 (layered for online viewing)  
 89EBP0604S Eval Board Schematics (optimized for printing)

### 89HP0604SB 4-channel SAS/SATA 6G Signal Repeater

89HP0604SB Product Brief  
 89HP0604SB Data Sheet  
 89HP0604SB Device Errata (Revision ZB)

### 89EBP0604SB Evaluation Board

User Manual  
 89EBP0604SB Eval Board Schematics  
 (layered for online viewing)  
 89EBP0604SB Eval Board Schematics  
 (optimized for printing)

### 89HP0608S 8-channel SAS/SATA 6G Signal Repeater

89HP0608S Product Brief  
 89HP0608S Data Sheet  
 89HP0608S Device Errata (Revision ZB)

### 89HP0604R 4-channel sRIO 2.1 Signal Repeater

89HP0604R Product Brief  
 89HP0604R Data Sheet  
 89HP0604R Device Errata (Revision ZB)

### 89HP0608R 8-channel sRIO 2.1 Signal Repeater

89HP0608R Product Brief  
 89HP0608R Data Sheet  
 89HP0608R Device Errata (Revision ZB)

### 89HP0604X 4-channel XAUI 6.25G Signal Repeater

89HP0604X Product Brief  
 89HP0604X Data Sheet  
 89HP0604X Device Errata (Revision ZB)

### 89HP0608X 8-channel XAUI 6.25G Signal Repeater

89HP0608X Product Brief  
 89HP0608X Data Sheet  
 89HP0608X Device Errata (Revision ZB)

### 89HP0602Q 2-channel 6.25Gbps Signal repeater

89HP0602Q Product Brief  
 89HP0602Q Data Sheet  
 89HP0602Q Device Errata (Revision ZB)

### 89EBP0602Q SATA Evaluation Board

User Manual  
 89EBP0602Q-SATA Eval Board Schematics  
 (layered for online viewing)  
 89EBP0602Q-SATA Eval Board Schematics  
 (optimized for printing)

### 89EBP0602Q USB Evaluation Board

89EBP0602Q-USB Eval Board Schematics  
 (layered for online viewing)  
 89EBP0602Q-USB Eval Board Schematics  
 (optimized for printing)  
 EBP0602Q USB Evaluation Board User Manual

### 89HP0604Q 4-channel 6.25Gbps Signal repeater

89HP0604Q Product Brief  
 89HP0604Q Data Sheet  
 89HP0604Q Device Errata (Revision ZB)

### 89HP0604QB 4-channel 6.25Gbps Signal repeater

89HP0604QB Product Brief  
 89HP0604QB Data Sheet  
 89HP0604QB Device Errata (Revision ZB)

### 89HT0808P 8-channel PCIe Gen3 Retimer

89HT0808P Product Brief

### 89HT0816P 16-channel PCIe Gen3 Retimer

89HT0816P Product Brief

## APPLICATION NOTES AND WHITE PAPERS

AN-729, IDT Signal Repeater Interoperability Report  
 AN-784, Extending Cable/Trace Lengths  
 with IDT PCIe Repeaters  
 AN-785, Extending Cable/Trace Lengths  
 with IDT USB3.0 Repeaters  
 AN-786, Extending Cable/Trace Length  
 with IDT SAS/SATA Repeaters  
 AN-787, Extending Cable Trace Lengths  
 with IDT XAUI Repeaters  
 PCIe Gen3 Equalization Training & IDT Retimers

## SOFTWARE

IDT Signal Manager Software for Signal Repeaters  
 IDT Signal Manager - Software User  
 Manual For Signal Repeaters  
 IDT Signal Manager Software for Signal Re-Timers

## EVALUATION KITS

### P0508P 16-lane PCIe G2 Evaluation Board

16-lane Slot

I<sup>2</sup>C

16-lane Finger Connection



USB to I<sup>2</sup>C Bridge  
(option for configuration)

Configuration Switches

### PCIe G2 EVALUATION BOARDS

89KT0508P  
16-lane,  
with USB/I<sup>2</sup>C  
Configuration



89KT0504P  
16-lane,  
with USB/I<sup>2</sup>C  
and Pin  
Configuration

89KT0504P-QFN  
16-lane,  
with USB/I<sup>2</sup>C  
Configuration



89KT0504PB-QFN  
16-lane, with  
Pin Configuration



### PCIe PASSIVE TRACE CARDS

Available by request with other PCIe Repeater card purchases | All are 16-lanes



6-inch



12-inch



24-inch

## USB 3.0 EVALUATION BOARDS



**89KT0504U**  
2-lane, with I<sup>2</sup>C Configuration



**89KT0504UB**  
2-lane, with Pin Configuration



**89KT0602Q-USB**  
1-lane, with Pin Configuration

## SATA EVALUATION BOARDS

All support 6Gbps SATA operation



**89KT0604S**  
2-lane, with I<sup>2</sup>C Configuration



**89KT0604SB**  
2-lane, with Pin Configuration



**89KT0602Q-SATA**  
1-lane, with Pin Configuration

## EVALUATION BOARD ORDERING INFORMATION

Protocol	Device	Description	KIT Ordering Code
PCIe Gen 2	P0504P	P0504P (100-BGA), 16-lane, 5Gbps, PCIeG2 Evaluation Board	89KTP0504P-BGA
PCIe Gen 2	P0504P	P0504P (36-QFN), 16-lane, 5Gbps, PCIeG2 Evaluation Board	89KTP0504P-QFN
PCIe Gen 2	P0504PB	P0504PB (36-QFN), 16-lane, 5Gbps, PCIeG2 Evaluation Board	89KTP0504PB-QFN
PCIe Gen 2	P0504P	P0504P (36-QFN), 1-lane cable, 5Gbps, PCIeG2 Evaluation Board	89KTP0504P-QFN-2
PCIe Gen 2	P0504PB	P0504PB (36-QFN), 1-lane cable, 5Gbps, PCIeG2 Evaluation Board	89KTP0504PB-QFN-2
PCIe Gen 2	P0508P	P0508P (100-BGA), 16-lane, 5Gbps, PCIeG2 Evaluation Board	89KTP0508P
SATA 6Gbps	P0604S	P0604S (36-QFN), 2-port, 6Gbps,	89KTP0604S
SATA 6Gbps	P0604SB	P0604SB (36-QFN), 2-port, 6Gbps, SATA Evaluation Board	89KTP0604SB
USB 3.0	P0504U	P0504U (36-QFN), 2-lane, 5Gbps, USB3 Evaluation Board	89KTP0504U
USB 3.0	P0504UB	P0504UB (36-QFN), 2-lane, 5Gbps, USB3 Evaluation Board	89KTP0504UB
Multi	P0602Q	P0602Q (20-QFN), 2-lane, 5Gbps, USB3 Evaluation Board	89KTP0602Q-USB
Multi	P0602Q	P0602Q (20-QFN), 2-lane, 6Gbps, SATA Evaluation Board	89KTP0602Q-SATA

## CONFIGURATION UTILITY



So that performance optimization is easy, IDT supplies a Windows GUI configuration utility

- Extensive control of all key operating parameters is possible
- EEPROM programming for multiple devices is also supported

DISCLAIMER Integrated Device Technology, Inc. (IDT) and its subsidiaries reserve the right to modify the products and/or specifications described herein at any time and at IDT's sole discretion. All information in this document, including descriptions of product features and performance, is subject to change without notice. Performance specifications and the operating parameters of the described products are determined in the independent state and are not guaranteed to perform the same way when installed in customer products. The information contained herein is provided without representation or warranty of any kind, whether express or implied, including, but not limited to, the suitability of IDT's products for any particular purpose, an implied warranty of merchantability, or non-infringement of the intellectual property rights of others. This document is presented only as a guide and does not convey any license under intellectual property rights of IDT or any third parties. IDT's products are not intended for use in life support systems or similar devices where the failure or malfunction of an IDT product can be reasonably expected to significantly affect the health or safety of users. Anyone using an IDT product in such a manner does so at their own risk, absent an express, written agreement by IDT.

Integrated Device Technology, IDT and the IDT logo are registered trademarks of IDT. Other trademarks and service marks used herein, including protected names, logos and designs, are the property of IDT or their respective third party owners. © Copyright 2011. All rights reserved.

OV\_SIPFAMILY\_REVA0311

## Данный компонент на территории Российской Федерации

### Вы можете приобрести в компании MosChip.

Для оперативного оформления запроса Вам необходимо перейти по данной ссылке:

<http://moschip.ru/get-element>

Вы можете разместить у нас заказ для любого Вашего проекта, будь то серийное производство или разработка единичного прибора.

В нашем ассортименте представлены ведущие мировые производители активных и пассивных электронных компонентов.

Нашей специализацией является поставка электронной компонентной базы двойного назначения, продукции таких производителей как XILINX, Intel (ex.ALTERA), Vicor, Microchip, Texas Instruments, Analog Devices, Mini-Circuits, Amphenol, Glenair.

Сотрудничество с глобальными дистрибьюторами электронных компонентов, предоставляет возможность заказывать и получать с международных складов практически любой перечень компонентов в оптимальные для Вас сроки.

На всех этапах разработки и производства наши партнеры могут получить квалифицированную поддержку опытных инженеров.

Система менеджмента качества компании отвечает требованиям в соответствии с ГОСТ Р ИСО 9001, ГОСТ РВ 0015-002 и ЭС РД 009

### Офис по работе с юридическими лицами:

105318, г.Москва, ул.Щербаковская д.3, офис 1107, 1118, ДЦ «Щербаковский»

Телефон: +7 495 668-12-70 (многоканальный)

Факс: +7 495 668-12-70 (доб.304)

E-mail: [info@moschip.ru](mailto:info@moschip.ru)

Skype отдела продаж:

moschip.ru

moschip.ru\_4

moschip.ru\_6

moschip.ru\_9