

SPECIFICATION

■ 1 SLOT Single output (150W) MS-150

OUTPUT (MS-150)	OUTPUT VOLTAGE CODE	MS-150A	MS-150B	MS-150C	MS-150D	MS-150E	MS-150F	MS-150G	MS-150H	MS-150I	MS-150J	MS-150K	
	DC VOLTAGE	2V	3.3V	5V	7.5V	12V	15V	18V	24V	27V	33V	48V	
	RATED CURRENT	25A	25A	25A	18A	13A	10A	8.5A	6.5A	5.8A	4.7A	3.2A	
	CURRENT RANGE	0 ~ 25A	0 ~ 25A	0 ~ 25A	0 ~ 18A	0 ~ 13A	0 ~ 10A	0 ~ 8.5A	0 ~ 6.5A	0 ~ 5.8A	0 ~ 4.7A	0 ~ 3.2A	
	PEAK LOAD <small>Note.4</small>	30A	30A	30A	20.7A	15A	11.5A	9.8A	7.5A	6.7A	5.4A	3.68A	
	RATED POWER	50W	82.5W	125W	135W	156W	150W	153W	156W	156.6W	155.1W	153.6W	
	RIPPLE & NOISE (max.) <small>Note.2</small>	50mVp-p	80mVp-p	80mVp-p	100mVp-p	150mVp-p	150mVp-p	150mVp-p	150mVp-p	150mVp-p	250mVp-p	250mVp-p	
	VOLTAGE ADJ. RANGE	1.6 ~ 2.6V	2.6 ~ 4V	4 ~ 6V	6 ~ 9V	9 ~ 13.2V	13.2 ~ 16.8V	16.8 ~ 20V	20 ~ 26.4V	25 ~ 31V	30 ~ 40V	40 ~ 53V	
	VOLTAGE TOLERANCE <small>Note.3</small>	±3.0%	±2.0%	±2.0%	±2.0%	±1.0%	±1.0%	±1.0%	±1.0%	±1.0%	±1.0%	±1.0%	
	LINE REGULATION	±0.5%	±0.5%	±0.5%	±0.5%	±0.3%	±0.3%	±0.3%	±0.2%	±0.2%	±0.2%	±0.2%	
	LOAD REGULATION	±2.0%	±1.0%	±1.0%	±1.0%	±0.5%	±0.5%	±0.5%	±0.5%	±0.5%	±0.5%	±0.5%	
	SETUP, RISE, HOLD UP TIME	1500ms, 50ms, 20ms at full load											
PROTECTION	OVERLOAD	121 ~ 150% rated output power				116 ~ 150% rated output power							
	OVER VOLTAGE	Protection type : Constant current limiting, recovers automatically after fault condition is removed											
FUNCTION	REMOTE INHIBIT CONTROL	RC+/RC-: 0 ~ 0.8V or OPEN, POWER ON						RC+/RC-: 4 ~ 12V POWER OFF					

■ 1 SLOT Single output (210W) MS-210

OUTPUT (MS-210)	OUTPUT VOLTAGE CODE	MS-210-1A	MS-210-1B	MS-210-1C	MS-210-1D	MS-210-1E	MS-210-1F	MS-210-1G	MS-210-1H	MS-210-1I	MS-210-1J	MS-210-1K	
	DC VOLTAGE	2V	3.3V	5V	7.5V	12V	15V	18V	24V	27V	33V	48V	
	RATED CURRENT	35A	35A	35A	28A	17.5A	14A	11.6A	8.75A	7.8A	6.4A	4.4A	
	CURRENT RANGE	0 ~ 35A	0 ~ 35A	0 ~ 35A	0 ~ 28A	0 ~ 17.5A	0 ~ 14A	0 ~ 11.6A	0 ~ 8.75A	0 ~ 7.8A	0 ~ 6.4A	0 ~ 4.4A	
	PEAK LOAD <small>Note.4</small>	38.5A	38.5A	38.5A	32.2A	20.1A	16.1A	13.4A	10.1A	9A	7.4A	5.1A	
	RATED POWER	70W	115.5W	175W	210W	210W	210W	208.8W	210W	210.6W	211.2W	211.2W	
	RIPPLE & NOISE (max.) <small>Note.2</small>	50mVp-p	80mVp-p	80mVp-p	100mVp-p	150mVp-p	150mVp-p	150mVp-p	150mVp-p	150mVp-p	250mVp-p	250mVp-p	
	VOLTAGE ADJ. RANGE	1.6 ~ 2.6V	2.6 ~ 4V	4 ~ 6V	6 ~ 9V	9 ~ 13.2V	13.2 ~ 16.8V	16.8 ~ 20V	20 ~ 26.4V	25 ~ 31V	30 ~ 40V	40 ~ 53V	
	VOLTAGE TOLERANCE <small>Note.3</small>	±3.0%	±2.0%	±2.0%	±2.0%	±1.0%	±1.0%	±1.0%	±1.0%	±1.0%	±1.0%	±1.0%	
	LINE REGULATION	±0.5%	±0.5%	±0.5%	±0.5%	±0.3%	±0.3%	±0.3%	±0.2%	±0.2%	±0.2%	±0.2%	
	LOAD REGULATION	±2.0%	±1.5%	±1.0%	±1.0%	±0.5%	±0.5%	±0.5%	±0.5%	±0.5%	±0.5%	±0.5%	
	SETUP, RISE, HOLD UP TIME	1500ms, 50ms, 20ms at full load											
PROTECTION	OVERLOAD	110 ~ 135% rated output power				116 ~ 150% rated output power							
	OVER VOLTAGE	Protection type : Constant current limiting, recovers automatically after fault condition is removed											
FUNCTION	REMOTE INHIBIT CONTROL	RC+/RC-: 0 ~ 0.8V or OPEN, POWER ON						RC+/RC-: 4 ~ 12V POWER OFF					

■ 2 SLOT Single output (300W) MS-300

OUTPUT (MS-300)	OUTPUT VOLTAGE CODE	MS-300-2A	MS-300-2B	MS-300-2C	MS-300-2D	MS-300-2E	MS-300-2F	MS-300-2G	MS-300-2H	MS-300-2I	MS-300-2J	MS-300-2K	
	DC VOLTAGE	2V	3.3V	5V	7.5V	12V	15V	18V	24V	27V	33V	48V	
	RATED CURRENT	50A	50A	50A	40A	25A	20A	16.7A	12.5A	11.2A	9.1A	6.3A	
	CURRENT RANGE	0 ~ 50A	0 ~ 50A	0 ~ 50A	0 ~ 40A	0 ~ 25A	0 ~ 20A	0 ~ 16.7A	0 ~ 12.5A	0 ~ 11.2A	0 ~ 9.1A	0 ~ 6.3A	
	PEAK LOAD <small>Note.4</small>	57.5A	57.5A	57.5A	46A	29A	23A	19.2A	14.4A	12.9A	10.5A	7.2A	
	RATED POWER	100W	165W	250W	300W	300W	300W	300.6W	300W	302.4W	300.3W	302.4W	
	RIPPLE & NOISE (max.) <small>Note.2</small>	80mVp-p	80mVp-p	80mVp-p	100mVp-p	150mVp-p	150mVp-p	150mVp-p	150mVp-p	200mVp-p	250mVp-p	300mVp-p	
	VOLTAGE ADJ. RANGE	1.6 ~ 2.6V	2.6 ~ 4V	4 ~ 6V	6 ~ 9V	9 ~ 13.2V	13.2 ~ 16.8V	16.8 ~ 20V	20 ~ 26.4V	25 ~ 31V	30 ~ 40V	40 ~ 53V	
	VOLTAGE TOLERANCE <small>Note.3</small>	±3.0%	±2.0%	±2.0%	±2.0%	±1.0%	±1.0%	±1.0%	±1.0%	±1.0%	±1.0%	±1.0%	
	LINE REGULATION	±0.5%	±0.5%	±0.5%	±0.5%	±0.3%	±0.3%	±0.3%	±0.2%	±0.2%	±0.2%	±0.2%	
	LOAD REGULATION	±2.0%	±1.0%	±1.0%	±1.0%	±0.5%	±0.5%	±0.5%	±1.0%	±1.0%	±1.0%	±1.0%	
	SETUP, RISE, HOLD UP TIME	1500ms, 50ms, 20ms at full load											
PROTECTION	OVERLOAD	116 ~ 150% rated output power											
	OVER VOLTAGE	Protection type : Constant current limiting, recovers automatically after fault condition is removed											
FUNCTION	REMOTE INHIBIT CONTROL	RC+/RC-: 0 ~ 0.8V or OPEN, POWER ON						RC+/RC-: 4 ~ 12V POWER OFF					

■ 2 SLOT Single output (360W) MS-360

OUTPUT (MS-360)	OUTPUT VOLTAGE CODE	MS-360-3A	MS-360-3B	MS-360-3C	MS-360-3D	MS-360-3E	MS-360-3F	MS-360-3G	MS-360-3H	MS-360-3I	MS-360-3J	MS-360-3K	
	DC VOLTAGE	2V	3.3V	5V	7.5V	12V	15V	18V	24V	27V	33V	48V	
	RATED CURRENT	60A	60A	60A	48A	30A	24A	20A	15A	13.4A	11A	7.5A	
	CURRENT RANGE	0 ~ 60A	0 ~ 60A	0 ~ 60A	0 ~ 48A	0 ~ 30A	0 ~ 24A	0 ~ 20A	0 ~ 15A	0 ~ 13.4A	0 ~ 11A	0 ~ 7.5A	
	PEAK LOAD <small>Note.4</small>	69A	69A	69A	55.2A	34.5A	27.6A	23A	17.3A	15.5A	12.7A	8.7A	
	RATED POWER	120W	198W	300W	360W	360W	360W	360W	360W	361.8W	363W	360W	
	RIPPLE & NOISE (max.) <small>Note.2</small>	80mVp-p	100mVp-p	100mVp-p	100mVp-p	150mVp-p	150mVp-p	150mVp-p	150mVp-p	200mVp-p	250mVp-p	300mVp-p	
	VOLTAGE ADJ. RANGE	1.6 ~ 2.6V	2.6 ~ 4V	4 ~ 6V	6 ~ 9V	9 ~ 13.2V	13.2 ~ 16.8V	16.8 ~ 20V	20 ~ 26.4V	25 ~ 31V	30 ~ 40V	40 ~ 53V	
	VOLTAGE TOLERANCE <small>Note.3</small>	±3.0%	±2.0%	±2.0%	±2.0%	±1.0%	±1.0%	±1.0%	±1.0%	±1.0%	±1.0%	±1.0%	
	LINE REGULATION	±0.5%	±0.5%	±0.5%	±0.5%	±0.3%	±0.3%	±0.3%	±0.2%	±0.2%	±0.2%	±0.2%	
	LOAD REGULATION	±2.0%	±1.5%	±1.0%	±1.0%	±0.5%	±0.5%	±0.5%	±1.0%	±1.0%	±1.0%	±1.0%	
	SETUP, RISE, HOLD UP TIME	1500ms, 50ms, 20ms at full load											
PROTECTION	OVERLOAD	116 ~ 150% rated output power											
	OVER VOLTAGE	Protection type : Constant current limiting, recovers automatically after fault condition is removed											
FUNCTION	REMOTE INHIBIT CONTROL	RC+/RC-: 0 ~ 0.8V or OPEN, POWER ON						RC+/RC-: 4 ~ 12V POWER OFF					

SPECIFICATION

■ 1 SLOT Single output (75W) MS-75

OUTPUT (MS-75)	OUTPUT VOLTAGE CODE	MS-75L	MS-75M	MS-75N	MS-75O	MS-75P	MS-75Q
	DC VOLTAGE	3.3V	5V	12V	15V	24V	48V
	RATED CURRENT	15A	15A	6.3A	5A	3.2A	1.6A
	CURRENT RANGE	0 ~ 15A	0 ~ 15A	0 ~ 6.3A	0 ~ 5A	0 ~ 3.2A	0 ~ 1.6A
	PEAK LOAD <small>Note.4</small>	17.3A	17.3A	7.3A	5.8A	3.7A	1.8A
	RATED POWER	49.5W	75W	75.6W	75W	76.8W	76.8W
	RIPPLE & NOISE (max.) <small>Note.2</small>	80mVp-p	80mVp-p	150mVp-p	150mVp-p	150mVp-p	250mVp-p
	VOLTAGE ADJ. RANGE	2.6 ~ 4V	4 ~ 6V	9 ~ 13.2V	13.2 ~ 16.8V	20 ~ 26.4V	40 ~ 53V
	VOLTAGE TOLERANCE <small>Note.3</small>	±2.0%	±2.0%	±1.0%	±1.0%	±1.0%	±1.0%
	LINE REGULATION	±0.5%	±0.5%	±0.3%	±0.3%	±0.2%	±0.2%
	LOAD REGULATION	±1.0%	±1.0%	±0.5%	±0.5%	±0.5%	±0.5%
SETUP, RISE, HOLD UP TIME	1500ms, 50ms, 20ms at full load						
PROTECTION	OVERLOAD	116 ~ 150% rated output power Protection type : Constant current limiting, recovers automatically after fault condition is removed					
	OVER VOLTAGE	4.1 ~ 5V	6.1 ~ 7.5V	13.3 ~ 18V	16.9 ~ 22V	26.5 ~ 35V	53.1 ~ 60V
FUNCTION	REMOTE INHIBIT CONTROL	RC+/RC-: 0 ~ 0.8V or OPEN, POWER ON RC+/RC-: 4 ~ 12V POWER OFF					

■ 1 SLOT Isolated Dual output (100W) MD-100

OUTPUT (MD-100)	OUTPUT VOLTAGE CODE	MD-100R		MD-100S		MD-100T		MD-100U		MD-100V		MD-100W		MD-100X			
	DC VOLTAGE	5V	5V	5V	12V	5V	15V	24V	5V	24V	12V	12V	12V	12V	15V	15V	
	RATED CURRENT	10A	8A	10A	4.2A	10A	3.4A	2.5A	8A	2.5A	3.4A	5A	3.4A	4A	2.7A	2.7A	
	CURRENT RANGE	2 ~ 10A	0 ~ 8A	2 ~ 10A	0 ~ 5.8A	2 ~ 10A	0 ~ 4.7A	0.5 ~ 3A	0 ~ 10A	0.6 ~ 3A	0 ~ 4.7A	1 ~ 5A	0 ~ 5.8A	1 ~ 4.7A	0 ~ 4.7A	0 ~ 4.7A	
	RATED POWER <small>Note.6</small>	90W		100.4W		101W		100W		100.8W		100.8W		100.5W		100.5W	
	RIPPLE & NOISE (max.) <small>Note.2</small>	100mVp-p	100mVp-p	100mVp-p	150mVp-p	100mVp-p	150mVp-p	200mVp-p	100mVp-p	240mVp-p	120mVp-p	120mVp-p	120mVp-p	120mVp-p	150mVp-p	150mVp-p	
	VOLTAGE ADJ. RANGE	4.75 ~ 5.5V	4.75 ~ 5.5V	4.75 ~ 5.5V	11.4 ~ 13.2V	4.75 ~ 5.5V	14.2 ~ 16.5V	22.8 ~ 26.4V	4.75 ~ 5.5V	22.8 ~ 26.4V	11.4 ~ 13.2V	11.4 ~ 13.2V	11.4 ~ 13.2V	11.4 ~ 13.2V	14.2 ~ 16.5V	14.2 ~ 16.5V	
	VOLTAGE TOLERANCE <small>Note.3</small>	±3.0%	±3.0%	±3.0%	±3.0%	±3.0%	±3.0%	±3.0%	±3.0%	±2.0%	±3.0%	±2.0%	±3.0%	±2.0%	±3.0%	±3.0%	
	LINE REGULATION	±1.0%	±1.0%	±1.0%	±1.0%	±1.0%	±1.0%	±1.0%	±1.0%	±0.5%	±1.0%	±0.5%	±1.0%	±0.5%	±1.0%	±1.0%	
	LOAD REGULATION	±2.0%	±2.0%	±2.0%	±2.0%	±2.0%	±2.0%	±2.0%	±2.0%	±1.0%	±2.0%	±1.0%	±2.0%	±1.0%	±2.0%	±2.0%	
	SETUP, RISE, HOLD UP TIME	1500ms, 50ms, 20ms at full load															
PROTECTION	OVERLOAD	105 ~ 150% rated output power Protection type : Shut down o/p voltage, re-power on to recover															
	OVER VOLTAGE	5.6 ~ 7.2V	5.6 ~ 7.2V	5.6 ~ 7.2V	13.3 ~ 17V	5.6 ~ 7.2V	16.6 ~ 22V	26.5 ~ 34V	5.6 ~ 7.2V	26.5 ~ 34V	13.3 ~ 17V	13.3 ~ 17V	13.3 ~ 17V	13.3 ~ 17V	16.6 ~ 22V	16.6 ~ 22V	
FUNCTION	REMOTE INHIBIT CONTROL	RC+/RC-: 0 ~ 0.8V or OPEN, POWER ON RC+/RC-: 4 ~ 12V POWER OFF															
NOTE	<p>1. MP450: The value changed by installing different output modules. The efficiency in specification means output modules are composed by following modules. 5V(Voltage code C)*1, 12V(Voltage code E)*1, 24V(Voltage code H)*1, 5V(Voltage code M)*1.</p> <p>MP650: The value changed by installing different output modules. The efficiency in specification means output modules are composed by following modules. 5V(Voltage code C)*2, 12V(Voltage code E)*1, 24V(Voltage code H)*2.</p> <p>MP1K0: The value changed by installing different output modules. The efficiency in specification means output modules are composed by following modules. 5V(Voltage code C)*2, 12V(Voltage code E)*2, 24V(Voltage code H)*3.</p> <p>The hold-up time of above combination is 20ms(typ.)</p> <p>2. Ripple & noise are measured at 20MHz of bandwidth by using a 12" twisted pair-wire terminated with a 0.1uf & 47uf parallel capacitor.</p> <p>3. Tolerance : includes set up tolerance, line regulation and load regulation.</p> <p>4. 35% Duty cycle maximum within every 10 seconds. Average output power should not exceed the rated power.</p> <p>5. The power supply is considered a component which will be installed into a final equipment. All the EMC tests are been executed by mounting the unit on a 720mm*360mm metal plate with 1mm of thickness. The final equipment must be re-confirmed that it still meets EMC directives. For guidance on how to perform these EMC tests, please refer to "EMI testing of component power supplies." (as available on http://www.meanwell.com)</p> <p>6. If the output voltage adjust to higher level, the rated current should be derated to meet the total rated power for both outputs(For MD-100 only).</p> <p>7. The ambient temperature derating of 3.5°C/1000m with fanless models and of 5°C/1000m with fan models for operating altitude higher than 2000m(6500ft).</p>																

Table 1. Parallel code(For MS-210、MS-300、MS-360 only)

Model	Code	SLOT1	SLOT2	SLOT3	SLOT4	SLOT5	SLOT6	SLOT7
MS-300/360	X						----	----
	1	○			○		----	----
	2		○			○	----	----
	3			○			○	
	4					○		○
	5	○			○		○	
MS-210	7	○	○					
	8	○	○	○	○			
	9	○	○	○	○	○		

※Code X,1,2,7,8,9 for MP450, MP650

※Code X,1,2,3,4,5,6,7,8,9 for MP1K0

※Maximum number of units for parallel function : 5 for MS-210, 3 for MS-300/360

■ Mechanical Specification

Unit:mm

MP450

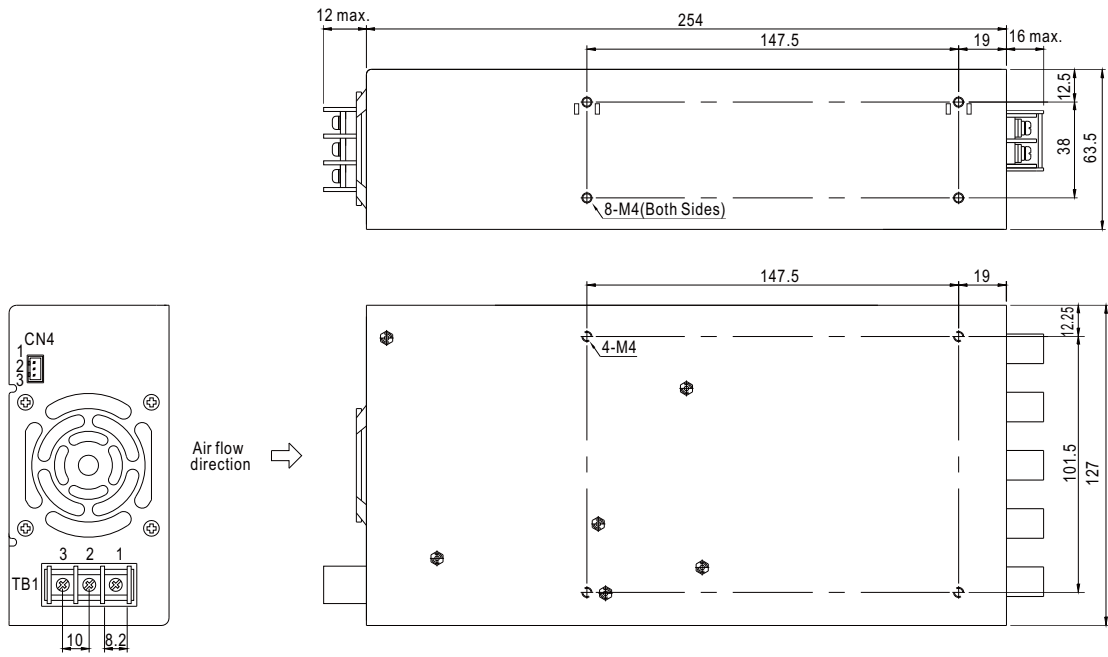

MP650

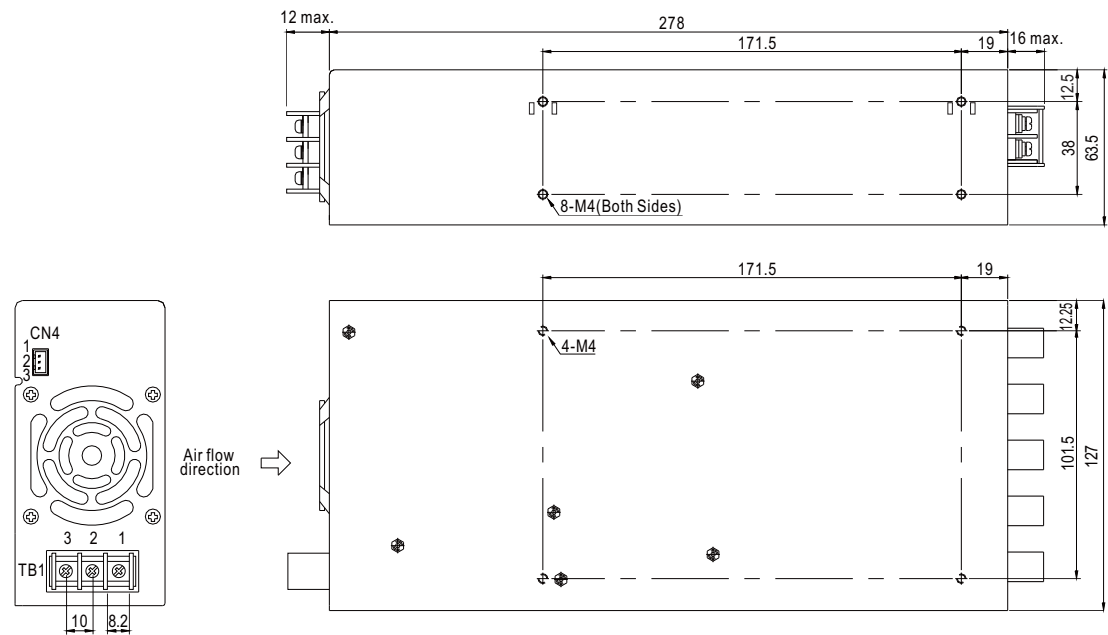

■ Mechanical Specification

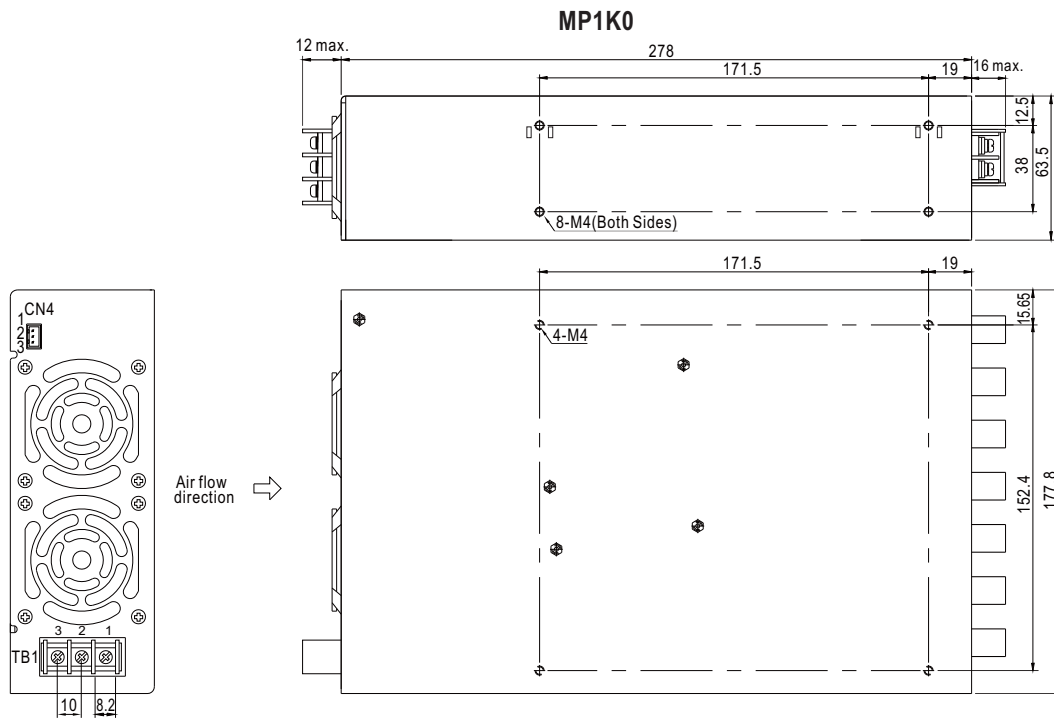

TB1(PFC-450/650/1K0)

Pin No.	Assignment
1	AC/L
2	AC/N
3	FG \perp

CN4(PFC-450/650/1K0) : JST B3B-XH or equivalent

Pin No.	Assignment	Mating Housing	Terminal
1	+RC: +Remote ON/OFF	JST XHP or equivalent	JST SXH-001T-P0.6 or equivalent
2	-RC: -Remote ON/OFF		
3	VCC: 12V/0.1A auxiliary output		

■ Mechanism of Output Modules

Unit:mm

◎MS-75

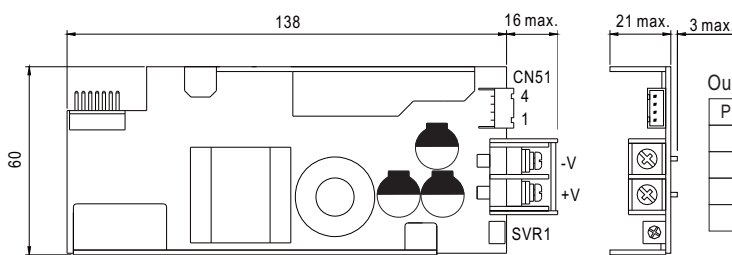

Output Connector(CN51) : JST B4B-XH or equivalent

Pin No.	Assignment	Mating Housing	Terminal
1	+S: +Remote sense	JST XHP or equivalent	JST SXH-001T-P0.6 or equivalent
2	-S: -Remote sense		
3	+RC: +Remote ON/OFF		
4	-RC: -Remote ON/OFF		

◎MS-150

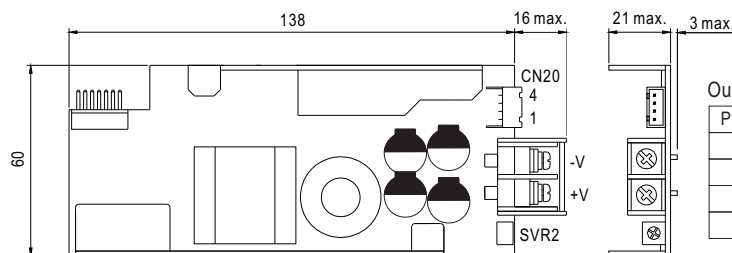

Output Connector(CN20) : JST B4B-XH or equivalent

Pin No.	Assignment	Mating Housing	Terminal
1	+S: +Remote sense	JST XHP or equivalent	JST SXH-001T-P0.6 or equivalent
2	-S: -Remote sense		
3	+RC: +Remote ON/OFF		
4	-RC: -Remote ON/OFF		

■ Mechanism of Output Modules

©MS-210

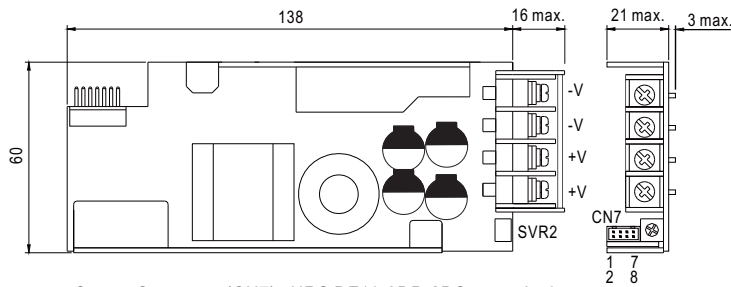

Output Connector(CN7) : HRS DF11-8DP-2DS or equivalent

Pin No.	Assignment	Pin No.	Assignment	Mating Housing	Terminal
1	+S: +Remote sense	5	CS: Current sharing	HRS DF11-8DS or equivalent	DRS DF11-SC or equivalent
2	-S: -Remote sense	6	G: GND		
3	+RC: +Remote ON/OFF	7	ML: Remote margin low control		
4	-RC: -Remote ON/OFF	8	M: Remote margin control		

- NOTE: 1.The voltage difference among each output should be minimized that less than 2% is required.
 2.The total output current must not exceed the value determined by the following equation.
 (Output current at parallel operation) = (The rated current per unit) × (Number of unit) × 0.9

©MS-300

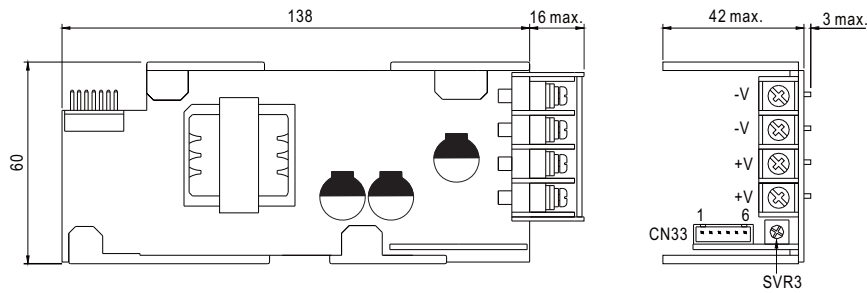

Output Connector(CN33) : JST B6B-XH or equivalent

Pin No.	Assignment	Mating Housing	Terminal
1	+S: +Remote sense	JST XHP or equivalent	JST SXH-001T-P0.6 or equivalent
2	-S: -Remote sense		
3	+RC: +Remote ON/OFF		
4	-RC: -Remote ON/OFF		
5	CS: Current sharing		
6	G: GND		

- NOTE: 1.The voltage difference among each output should be minimized that less than 2% is required.
 2.The total output current must not exceed the value determined by the following equation.
 (Output current at parallel operation) = (The rated current per unit) × (Number of unit) × 0.9

©MS-360

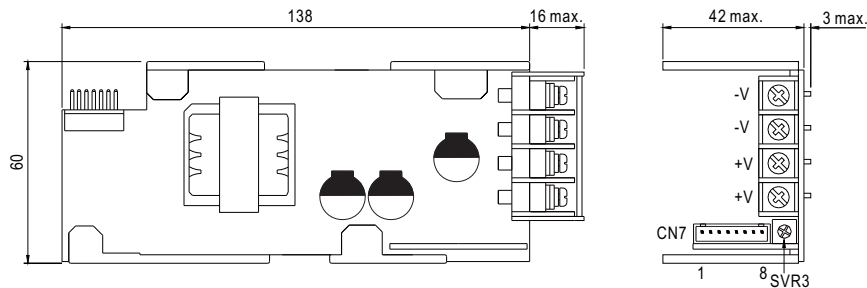

Output Connector(CN7) : JST B8B-XH or equivalent

Pin No.	Assignment	Pin No.	Assignment	Mating Housing	Terminal
1	+S: +Remote sense	5	CS: Current sharing	JST XHP or equivalent	JST SXH-001T-P0.6 or equivalent
2	-S: -Remote sense	6	G: GND		
3	+RC: +Remote ON/OFF	7	ML: Remote margin low control		
4	-RC: -Remote ON/OFF	8	M: Remote margin control		

- NOTE: 1.The voltage difference among each output should be minimized that less than 2% is required.
 2.The total output current must not exceed the value determined by the following equation.
 (Output current at parallel operation) = (The rated current per unit) × (Number of unit) × 0.9

■ Mechanism of Output Modules

©MD-100

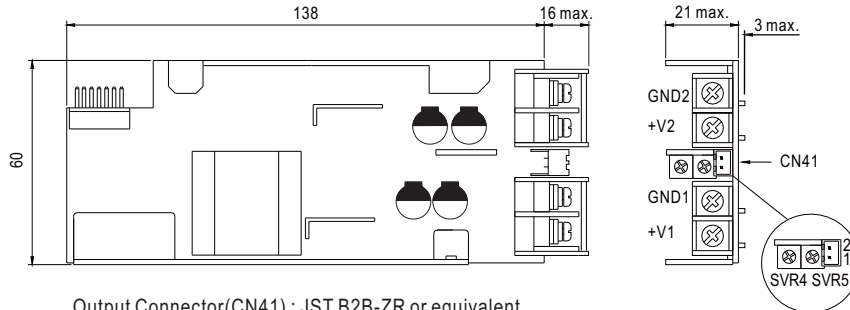

Output Connector(CN41) : JST B2B-ZR or equivalent

Pin No.	Assignment	Mating Housing	Terminal
1	+RC	JST ZHR-2 or equivalent	JST SZH-002T-P0.5 or equivalent
2	-RC		

- NOTE: 1.Remote ON/OFF of CN4 turn ON/OFF the entire power system
 2.Remote ON/OFF of CN20,CN33,CN41,CN51 turn ON/OFF the individual output module
 3.SVR1~5: DC output voltage adjustment(SVR4 for CH2 of MD-100,SVR5 for CH1 of MD-100)

■ Derating Curve

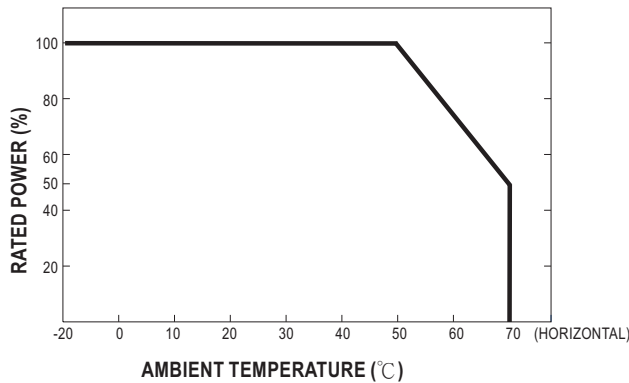

■ Static Characteristics

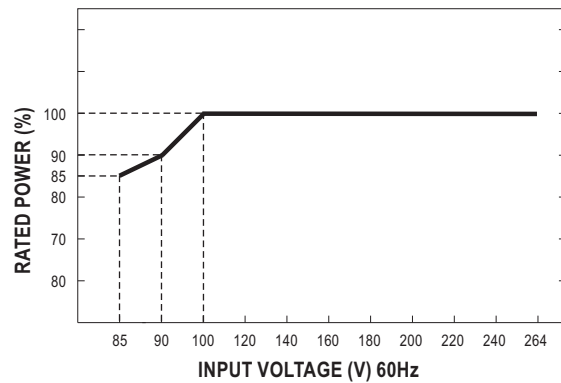

■ Remote Margin / V-Program

Remote Margin / V-Program is available for MS-210 and MS-360 to fine tune the output voltage. Hereunder is the instruction, assuming no voltage adjustment is applied via the built-in potentiometer.

- (1)When the function is not required, please have pin CN7-8 (refer to Mechanism of Output Modules) open, and the output voltage will present the nominal voltage.
- (2)Connecting pin CN7-8 with CN7-6 (or CN7-7) will tune the output voltage up (if CN7-7, down) by 5% of the nominal voltage.
- (3)Applying an additional 100K Ω potentiometer across CN7-6 and CN7-7 (referring to Figure 1) will enable the adjustment in between -5% and +5% (EX: -3%, +2.5%, and etc.)

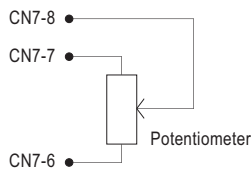

Figure 1

(Please refer to Mechanism of Output Modules)

Данный компонент на территории Российской Федерации

Вы можете приобрести в компании MosChip.

Для оперативного оформления запроса Вам необходимо перейти по данной ссылке:

<http://moschip.ru/get-element>

Вы можете разместить у нас заказ для любого Вашего проекта, будь то серийное производство или разработка единичного прибора.

В нашем ассортименте представлены ведущие мировые производители активных и пассивных электронных компонентов.

Нашей специализацией является поставка электронной компонентной базы двойного назначения, продукции таких производителей как XILINX, Intel (ex.ALTERA), Vicor, Microchip, Texas Instruments, Analog Devices, Mini-Circuits, Amphenol, Glenair.

Сотрудничество с глобальными дистрибьюторами электронных компонентов, предоставляет возможность заказывать и получать с международных складов практически любой перечень компонентов в оптимальные для Вас сроки.

На всех этапах разработки и производства наши партнеры могут получить квалифицированную поддержку опытных инженеров.

Система менеджмента качества компании отвечает требованиям в соответствии с ГОСТ Р ИСО 9001, ГОСТ РВ 0015-002 и ЭС РД 009

Офис по работе с юридическими лицами:

105318, г.Москва, ул.Щербаковская д.3, офис 1107, 1118, ДЦ «Щербаковский»

Телефон: +7 495 668-12-70 (многоканальный)

Факс: +7 495 668-12-70 (доб.304)

E-mail: info@moschip.ru

Skype отдела продаж:

moschip.ru

moschip.ru_4

moschip.ru_6

moschip.ru_9