



MICROCHIP

EVB-LAN9252-DIGIO
EtherCAT[®] Evaluation Board
User's Guide

Note the following details of the code protection feature on Microchip devices:

- Microchip products meet the specification contained in their particular Microchip Data Sheet.
- Microchip believes that its family of products is one of the most secure families of its kind on the market today, when used in the intended manner and under normal conditions.
- There are dishonest and possibly illegal methods used to breach the code protection feature. All of these methods, to our knowledge, require using the Microchip products in a manner outside the operating specifications contained in Microchip's Data Sheets. Most likely, the person doing so is engaged in theft of intellectual property.
- Microchip is willing to work with the customer who is concerned about the integrity of their code.
- Neither Microchip nor any other semiconductor manufacturer can guarantee the security of their code. Code protection does not mean that we are guaranteeing the product as “unbreakable.”

Code protection is constantly evolving. We at Microchip are committed to continuously improving the code protection features of our products. Attempts to break Microchip's code protection feature may be a violation of the Digital Millennium Copyright Act. If such acts allow unauthorized access to your software or other copyrighted work, you may have a right to sue for relief under that Act.

Information contained in this publication regarding device applications and the like is provided only for your convenience and may be superseded by updates. It is your responsibility to ensure that your application meets with your specifications. MICROCHIP MAKES NO REPRESENTATIONS OR WARRANTIES OF ANY KIND WHETHER EXPRESS OR IMPLIED, WRITTEN OR ORAL, STATUTORY OR OTHERWISE, RELATED TO THE INFORMATION, INCLUDING BUT NOT LIMITED TO ITS CONDITION, QUALITY, PERFORMANCE, MERCHANTABILITY OR FITNESS FOR PURPOSE. Microchip disclaims all liability arising from this information and its use. Use of Microchip devices in life support and/or safety applications is entirely at the buyer's risk, and the buyer agrees to defend, indemnify and hold harmless Microchip from any and all damages, claims, suits, or expenses resulting from such use. No licenses are conveyed, implicitly or otherwise, under any Microchip intellectual property rights.

Trademarks

The Microchip name and logo, the Microchip logo, dsPIC, FlashFlex, flexPWR, JukeBlox, KEELOQ, KEELOQ logo, Kleer, LANCheck, MediaLB, MOST, MOST logo, MPLAB, OptoLyzer, PIC, PICSTART, PIC³² logo, RightTouch, SpyNIC, SST, SST Logo, SuperFlash and UNI/O are registered trademarks of Microchip Technology Incorporated in the U.S.A. and other countries.

The Embedded Control Solutions Company and mTouch are registered trademarks of Microchip Technology Incorporated in the U.S.A.

Analog-for-the-Digital Age, BodyCom, chipKIT, chipKIT logo, CodeGuard, dsPICDEM, dsPICDEM.net, ECAN, In-Circuit Serial Programming, ICSP, Inter-Chip Connectivity, KleerNet, KleerNet logo, MiWi, MPASM, MPF, MPLAB Certified logo, MPLIB, MPLINK, MultiTRAK, NetDetach, Omniscient Code Generation, PICDEM, PICDEM.net, PICKit, PICTail, RightTouch logo, REAL ICE, SQI, Serial Quad I/O, Total Endurance, TSHARC, USBCheck, VariSense, ViewSpan, WiperLock, Wireless DNA, and ZENA are trademarks of Microchip Technology Incorporated in the U.S.A. and other countries.

SQTP is a service mark of Microchip Technology Incorporated in the U.S.A.

Silicon Storage Technology is a registered trademark of Microchip Technology Inc. in other countries.

GestIC is a registered trademarks of Microchip Technology Germany II GmbH & Co. KG, a subsidiary of Microchip Technology Inc., in other countries.

All other trademarks mentioned herein are property of their respective companies.

© 2014-2015, Microchip Technology Incorporated, Printed in the U.S.A., All Rights Reserved.

EtherCAT® is registered trademark and patented technology, licensed by Beckhoff Automation GmbH, Germany.

ISBN: 97816312773739

QUALITY MANAGEMENT SYSTEM
CERTIFIED BY DNV
== ISO/TS 16949 ==

Microchip received ISO/TS-16949:2009 certification for its worldwide headquarters, design and wafer fabrication facilities in Chandler and Tempe, Arizona; Gresham, Oregon and design centers in California and India. The Company's quality system processes and procedures are for its PIC® MCUs and dsPIC® DSCs, KEELOQ® code hopping devices, Serial EEPROMs, microperipherals, nonvolatile memory and analog products. In addition, Microchip's quality system for the design and manufacture of development systems is ISO 9001:2000 certified.

Object of Declaration: EVB-LAN9252-DIGIO

EU Declaration of Conformity

Manufacturer: Microchip Technology Inc.
2355 W. Chandler Blvd.
Chandler, Arizona, 85224-6199
USA

This declaration of conformity is issued by the manufacturer.

The development/evaluation tool is designed to be used for research and development in a laboratory environment. This development/evaluation tool is not a Finished Appliance, nor is it intended for incorporation into Finished Appliances that are made commercially available as single functional units to end users under EU EMC Directive 2004/108/EC and as supported by the European Commission's Guide for the EMC Directive 2004/108/EC (8th February 2010).

This development/evaluation tool complies with EU RoHS2 Directive 2011/65/EU.

This development/evaluation tool, when incorporating wireless and radio-telecom functionality, is in compliance with the essential requirement and other relevant provisions of the R&TTE Directive 1999/5/EC and the FCC rules as stated in the declaration of conformity provided in the module datasheet and the module product page available at www.microchip.com.

For information regarding the exclusive, limited warranties applicable to Microchip products, please see Microchip's standard terms and conditions of sale, which are printed on our sales documentation and available at www.microchip.com.

Signed for and on behalf of Microchip Technology Inc. at Chandler, Arizona, USA

Derek Carlson
VP Development Tools

12-Sep-14
Date

NOTES:

Table of Contents

Preface	6
Introduction.....	6
Document Layout	6
Conventions Used in this Guide	7
The Microchip Web Site	8
Development Systems Customer Change Notification Service	8
Customer Support	8
Document Revision History	9
 Chapter 1. Overview	
1.1 Introduction	10
1.2 References	11
1.3 Terms and Abbreviations	11
 Chapter 2. Board Details & Configuration	
2.1 Power	12
2.1.1 +5V Power	12
2.2 Resets	12
2.2.1 Power-on Reset	12
2.3 Clock	12
2.4 Configuration	13
2.4.1 Strap Options	14
2.4.2 LED Indicators	16
2.4.3 EEPROM Switch	17
2.4.4 DIG INPUT Mode	17
2.4.5 DIG OUTPUT Mode	17
2.4.6 DIG Bidirectional Mode	18
2.4.7 Control Signals	18
2.5 Mechanicals	19
 Chapter 3. LAN9252 EEPROM Programming	
3.1 Programming the LAN9252 EEPROM	20
 Appendix A. EVB-LAN9252-DIGIO Evaluation Board	
A.1 Introduction	23
 Appendix B. EVB-LAN9252-DIGIO Evaluation Board Schematics	
B.1 Introduction	24
 Appendix C. Bill of Materials (BOM)	
C.1 Introduction	32
 Worldwide Sales and Service	36

Preface

NOTICE TO CUSTOMERS

All documentation becomes dated, and this manual is no exception. Microchip tools and documentation are constantly evolving to meet customer needs, so some actual dialogs and/or tool descriptions may differ from those in this document. Please refer to our web site (www.microchip.com) to obtain the latest documentation available.

Documents are identified with a “DS” number. This number is located on the bottom of each page, in front of the page number. The numbering convention for the DS number is “DSXXXXA”, where “XXXX” is the document number and “A” is the revision level of the document.

For the most up-to-date information on development tools, see the MPLAB® IDE online help. Select the Help menu, and then Topics to open a list of available online help files.

INTRODUCTION

This chapter contains general information that will be useful to know before using the EVB-LAN9252-DIGIO. Items discussed in this chapter include:

- [Document Layout](#)
- [Conventions Used in this Guide](#)
- [The Microchip Web Site](#)
- [Development Systems Customer Change Notification Service](#)
- [Customer Support](#)
- [Document Revision History](#)

DOCUMENT LAYOUT

This document describes how to use the EVB-LAN9252-DIGIO as a development tool for the Microchip LAN9252 EtherCAT® slave controller. The manual layout is as follows:

- **Chapter 1. “Overview”** – Shows a brief description of the EVB-LAN9252-DIGIO.
- **Chapter 2. “Board Details & Configuration”** – Includes details and instructions for using the EVB-LAN9252-DIGIO.
- **Chapter 3. “LAN9252 EEPROM Programming”** – Includes details and instructions for programming the LAN9252 EEPROM.
- **Appendix A. “EVB-LAN9252-DIGIO Evaluation Board”** – This appendix shows the EVB-LAN9252-DIGIO.
- **Appendix B. “EVB-LAN9252-DIGIO Evaluation Board Schematics”** – This appendix shows the EVB-LAN9252-DIGIO schematics.
- **Appendix C. “Bill of Materials (BOM)”** – This appendix includes the EVB-LAN9252-DIGIO Bill of Materials (BOM).

CONVENTIONS USED IN THIS GUIDE

This manual uses the following documentation conventions:

DOCUMENTATION CONVENTIONS

Description	Represents	Examples
Arial font:		
Italic characters	Referenced books	<i>MPLAB[®] IDE User's Guide</i>
	Emphasized text	...is the <i>only</i> compiler...
Initial caps	A window	the Output window
	A dialog	the Settings dialog
	A menu selection	select Enable Programmer
Quotes	A field name in a window or dialog	"Save project before build"
Underlined, italic text with right angle bracket	A menu path	<u><i>File>Save</i></u>
Bold characters	A dialog button	Click OK
	A tab	Click the Power tab
N'Rnnnn	A number in verilog format, where N is the total number of digits, R is the radix and n is a digit.	4'b0010, 2'hF1
Text in angle brackets < >	A key on the keyboard	Press <Enter>, <F1>
Courier New font:		
Plain Courier New	Sample source code	#define START
	Filenames	autoexec.bat
	File paths	c:\mcc18\h
	Keywords	_asm, _endasm, static
	Command-line options	-Opa+, -Opa-
	Bit values	0, 1
	Constants	0xFF, 'A'
Italic Courier New	A variable argument	<i>file.o</i> , where <i>file</i> can be any valid filename
Square brackets []	Optional arguments	mcc18 [options] <i>file</i> [options]
Curly brackets and pipe character: { }	Choice of mutually exclusive arguments; an OR selection	errorlevel {0 1}
Ellipses...	Replaces repeated text	var_name [, var_name...]
	Represents code supplied by user	void main (void) { ... }

THE MICROCHIP WEB SITE

Microchip provides online support via our web site at www.microchip.com. This web site is used as a means to make files and information easily available to customers. Accessible by using your favorite Internet browser, the web site contains the following information:

- **Product Support** – Data sheets and errata, application notes and sample programs, design resources, user's guides and hardware support documents, latest software releases and archived software
- **General Technical Support** – Frequently Asked Questions (FAQs), technical support requests, online discussion groups, Microchip consultant program member listing
- **Business of Microchip** – Product selector and ordering guides, latest Microchip press releases, listing of seminars and events, listings of Microchip sales offices, distributors and factory representatives

DEVELOPMENT SYSTEMS CUSTOMER CHANGE NOTIFICATION SERVICE

Microchip's customer notification service helps keep customers current on Microchip products. Subscribers will receive e-mail notification whenever there are changes, updates, revisions or errata related to a specified product family or development tool of interest.

To register, access the Microchip web site at www.microchip.com, click on Customer Change Notification and follow the registration instructions.

The Development Systems product group categories are:

- **Compilers** – The latest information on Microchip C compilers, assemblers, linkers and other language tools. These include all MPLAB C compilers; all MPLAB assemblers (including MPASM assembler); all MPLAB linkers (including MPLINK object linker); and all MPLAB librarians (including MPLIB object librarian).
- **Emulators** – The latest information on Microchip in-circuit emulators. This includes the MPLAB REAL ICE and MPLAB ICE 2000 in-circuit emulators.
- **In-Circuit Debuggers** – The latest information on the Microchip in-circuit debuggers. This includes MPLAB ICD 3 in-circuit debuggers and PICkit 3 debug express.
- **MPLAB IDE** – The latest information on Microchip MPLAB IDE, the Windows Integrated Development Environment for development systems tools. This list is focused on the MPLAB IDE, MPLAB IDE Project Manager, MPLAB Editor and MPLAB SIM simulator, as well as general editing and debugging features.
- **Programmers** – The latest information on Microchip programmers. These include production programmers such as MPLAB REAL ICE in-circuit emulator, MPLAB ICD 3 in-circuit debugger and MPLAB PM3 device programmers. Also included are nonproduction development programmers such as PICSTART Plus and PIC-kit 2 and 3.

CUSTOMER SUPPORT

Users of Microchip products can receive assistance through several channels:

- Distributor or Representative
- Local Sales Office
- Field Application Engineer (FAE)
- Technical Support

Customers should contact their distributor, representative or field application engineer (FAE) for support. Local sales offices are also available to help customers. A listing of sales offices and locations is included in the back of this document.

Technical support is available through the web site at: <http://www.microchip.com/support>

DOCUMENT REVISION HISTORY

Revision	Section/Figure/Entry	Correction
DS50002332B (05-12-15)	All	Updated board name to “EVB-LAN9252-DIGIO” throughout document, corrected misc. typos and grammatical errors.
	Section 1.2 “References”	Updated list of application notes
DS50002332A	Initial Release of document	

Chapter 1. Overview

1.1 INTRODUCTION

The LAN9252 is a 2-port EtherCAT® slave controller with dual integrated Ethernet PHYs which each contain a full-duplex 100BASE-TX transceiver and support 100Mbps (100BASE-TX) operation. 100BASE-FX is supported via an external fiber transceiver.

Each port receives an EtherCAT® frame, performs frame checking and forwards it to the next port. Time stamps of received frames are generated when they are received. The Loop-back function of each port forwards the frames to the next logical port if there is either no link at a port, if the port is not available, or if the loop is closed for that port. The Loop-back function of port 0 forwards the frames to the EtherCAT® Processing Unit. The loop settings can be controlled by the EtherCAT® master.

Packets are forwarded in the following order:

Port 0 -> EtherCAT® Processing Unit -> Port 1 -> Port 2.

The EtherCAT® Processing Unit (EPU) receives, analyzes and processes the EtherCAT® data stream. The main purpose of the EtherCAT® Processing unit is to enable and coordinate access to the internal registers and the memory space of the ESC, which can be addressed both from the EtherCAT® master and from the local application. Data exchange between master and slave applications is comparable to a dual-ported memory (process memory), enhanced by special functions for consistency checking (SyncManager) and data mapping (FMMU). Each FMMU performs bitwise mapping of logical EtherCAT® system addresses to physical device addresses.

The scope of this document is to describe the EVB-LAN9252-DIGIO setup, which supports a Digital I/O PDI Interface and corresponding jumper configurations. The LAN9252 is connected to an RJ45 Ethernet jack with integrated magnetics for 100BASE-TX connectivity. A simplified block diagram of the EVB-LAN9252-DIGIO is shown in [Figure 1-1](#).

FIGURE 1-1: EVB-LAN9252-DIGIO BLOCK DIAGRAM

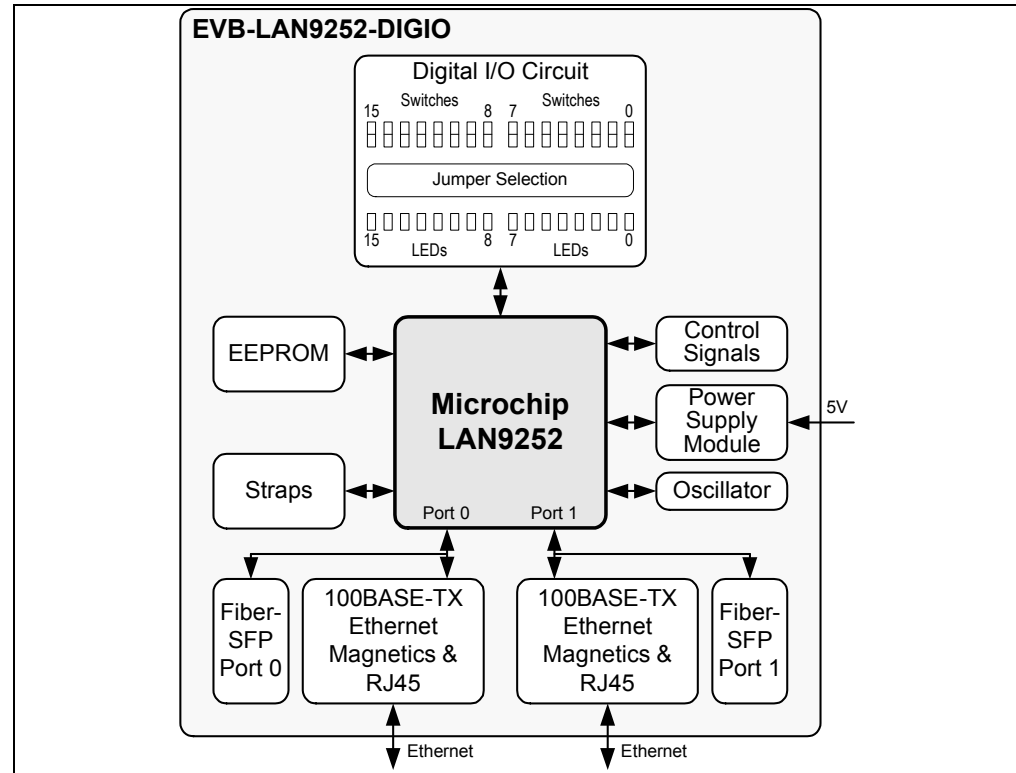

1.2 REFERENCES

Concepts and material available in the following documents may be helpful when reading this document. Visit www.microchip.com for the latest documentation.

- LAN9252 Data Sheet
- AN 8.13 Suggested Magnetics
- EVB-LAN9252-DIGIO Schematics
- AN1920 Microchip LAN9252 EEPROM Configuration and Programming
- AN1907 Microchip LAN9252 Migration from Beckhoff ET1100

1.3 TERMS AND ABBREVIATIONS

IDE - Integrated Development Environment
 ESC - EtherCAT® Slave Controller
 EVB - Engineering Validation Board
 HAL - Hardware Abstraction Layer
 HBI - Host Bus Interface
 SPI - Serial Protocol Interface
 SSC - Slave Stack Code

Chapter 2. Board Details & Configuration

This section includes sub-sections on the following EVB-LAN9252-DIGIO details:

- Power
- Resets
- Clock
- Configuration
- Mechanicals

2.1 POWER

2.1.1 +5V Power

Power is supplied to the LAN9252 by a +3.3V on-board regulator, which is powered by a +5V external wall adapter (Manufacturer: TRIAD MAGNETICS and P/N: WSU050-3000). The LAN9252 includes an internal +1.2V regulator which supplies power to the internal core logic. Assertion of the D1 Green LED indicates successful generation of +3.3V output. The SW1 switch must be in the ON position for the +5V to power the +3.3V regulator.

2.2 RESETS

2.2.1 Power-on Reset

A power-on reset occurs whenever power is initially applied to the LAN9252 or if the power is removed and reapplied to the LAN9252. This event resets all circuitry within the LAN9252. After initial power-on, the LAN9252 can be reset by pressing the reset switch SW2. The reset LED D2 will assert (Red) if when the LAN9252 is in reset condition. For stability, a delay of approximately 180ms is added from the +3.3V output to reset release.

2.3 CLOCK

The EVB-LAN9252-DIGIO utilizes an external 25Mhz 25ppm crystal from Cardinal Components Inc. (P/N: CSM1Z-A5B2C5-40-25.0D18-F).

Board Details & Configuration

2.4 CONFIGURATION

The following sub-sections describe the various board features and configuration settings. A top view of the EVB-LAN9252-DIGIO is shown in Figure 2-1.

FIGURE 2-1: EVB-LAN9252-DIGIO TOP VIEW WITH CALLOUTS

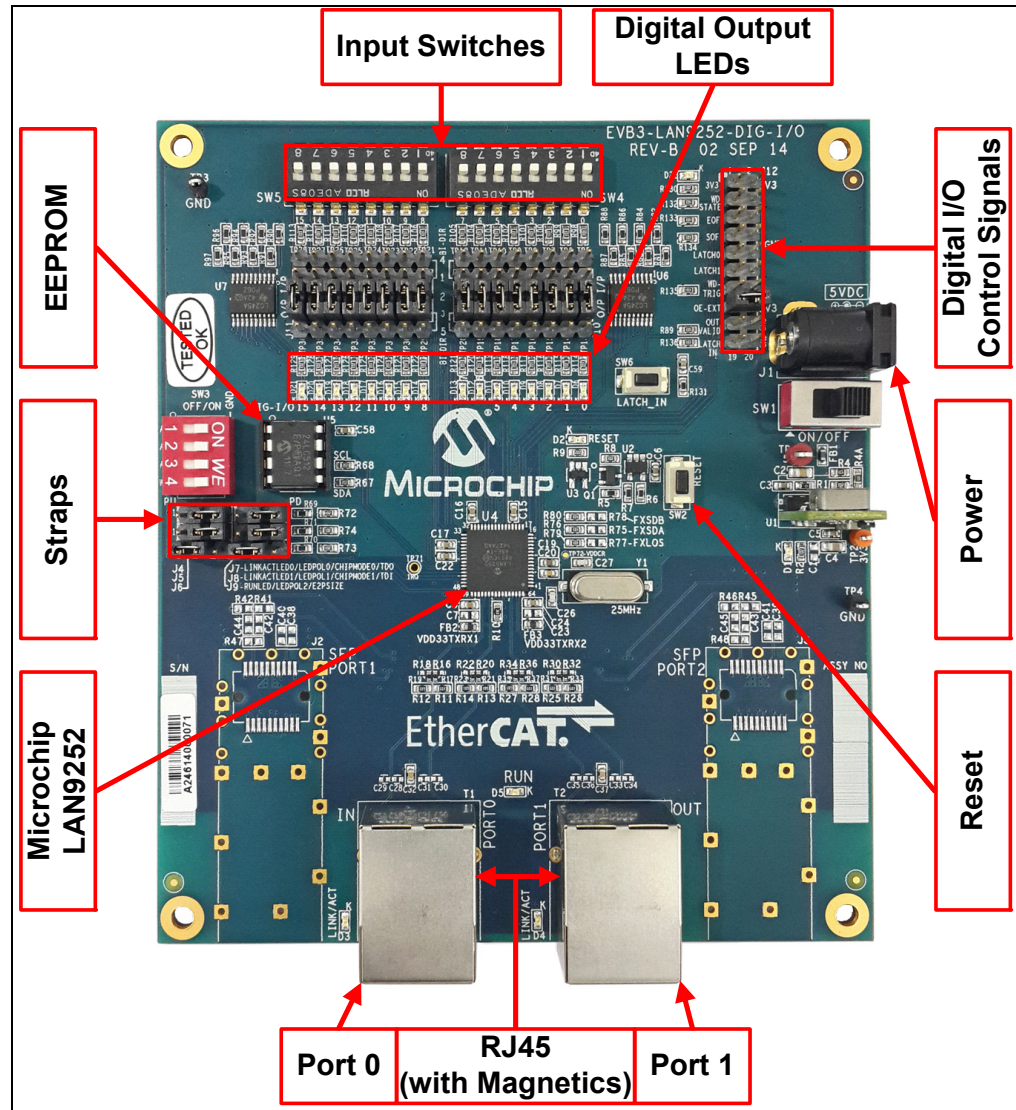

2.4.1 Strap Options

2.4.1.1 CHIP MODE SELECTION

Table 2-1 details the LAN9252 chip mode configuration straps.

TABLE 2-1: CHIP MODE CONFIGURATION STRAP

Header	Description	Pins	Settings
J4,J5,J7,J8	Chip mode configuration strap inputs. This strap determines the number of active ports and port types.	1-2 2-3	Short 1-2 for high (pull-up) (Not supported in this EVB) Short 2-3 for low (pull-down) (default)

Note: This EVB supports Chip mode 00 which is 2-port mode, where Port 0 = PHY A and Port 1 = PHY B. This requires J4, J5, J7, and J8 to be pulled-down (2-3) shorted. All other configurations are not supported by this EVB.

2.4.1.2 EEPROM SIZE CONFIGURATION

The EEPROM size configuration strap (J6 & J9) determines the supported EEPROM size range. A low selects 1Kbits (128 x 8) through 16Kbits (2K x 8)_24C16. A high selects 32Kbits (4K x 8) through 512Kbits (64K x 8) or 4Mbits (512K x 8)_24C512.

TABLE 2-2: EEPROM SIZE CONFIGURATION STRAP

Header	Description	Pins	Settings
J6, J9	EEPROM size configuration strap inputs. This strap determines the supported EEPROM size range.	1-2 2-3	Short 1-2 for high (pull-up) (default) Short 2-3 for low (pull-down)

2.4.1.3 COPPER AND FIBER STRAPS

The LAN9252 supports 100BASE-TX (Copper) and 100BASE-FX (Fiber) modes. In 100BASE-FX operation, the presence of the receive signal is indicated by the external transceiver as either an open-drain, CMOS level, Loss of Signal (SFP) or a LVPECL Signal Detect (SFF).

This EVB supports 100BASE-TX (Copper) and SFP 100BASE-FX (Fiber) modes. By default Copper Mode is active. Fiber Mode is supported as an assembly option. To select the Copper or Fiber Mode, the respective strap and signal routing resistor assembly options must to be configured.

Note: Vendor part number for SFP: Finisar/FTLF1217P2

Board Details & Configuration

2.4.1.3.1 Copper Mode

The EVB-LAN9252-DIGIO is set to Copper Mode by default. Table 2-3 details the required strap resistor settings for Copper Mode operation.

TABLE 2-3: COPPER MODE STRAP RESISTORS

Resistors	Description
R79 (10K)	Configures Port 0 & 1 to Copper Mode
R76, R80 (10K)	Configures Port 0 and Port 1 to Copper Mode, respectively

Note: R75, R77, and R78 must not be populated (DNP).

Additionally, the signal routing resistors detailed in Table 2-4 must be assembled for Copper Mode operation.

TABLE 2-4: COPPER MODE SIGNAL ROUTING RESISTORS

Resistors	Description
R17, R19, R21, R23	Port 0 Copper Mode enabled
R31, R33, R35, R37	Port 1 Copper mode enabled

Note: R16, R18, R20, R22, R30, R32, R34, and R36 (0402 package) must not be populated (DNP).

2.4.1.3.2 Fiber Mode

The EVB-LAN9252-DIGIO supports SFP type 100BASE-FX. To enable Fiber Mode, the respective strap and signal routing resistors must be configured.

Note: Copper Mode related resistors must be DNP while Fiber Mode is active (See **Section 2.4.1.3.1 “Copper Mode”**).

Table 2-5 details the required strap resistor settings for Fiber Mode operation.

TABLE 2-5: FIBER MODE STRAP RESISTORS

Resistors	Description
R77 (10K)	Configures Port 0 & 1 to FX-LOS Mode
R75, R78 (10K)	Configures Port 0 and Port 1 to Fiber Mode, respectively

Note: R76, R79, and R80 must not be populated (DNP).

Additionally, the signal routing resistors detailed in Table 2-6 must be assembled for Fiber Mode operation.

TABLE 2-6: FIBER MODE SIGNAL ROUTING RESISTORS

Resistors	Description
R16, R18, R20, R22	Port 0 Fiber Mode enabled
R30, R32, R34, R36	Port 1 Fiber mode enabled

Note: R17, R19, R21, R23, R31, R33, R35, and R37 (0402 package) must not be populated (DNP).

2.4.1.3.3 FX-LOS Fiber Mode Strap

FX-LOS strap details are shown in Table 2-7. These strap settings determine if the ports are to operate in FX-LOS Fiber Mode or FX-SD/Copper Mode.

TABLE 2-7: FX-LOS MODE STRAP SETTINGS

R77 (10K)	R79 (10K)	Reference Voltage (V)	Function
Populate	DNP	3.3	A level above 2V selects FX-LOS for Port 0 and Port 1
Populate	Populate	1.5	A level greater than 1.5V and below 2V selects FX-LOS for Port 0 and FX-SD / copper twisted pair for Port 1, further determined by FXSDB
DNP	Populate	0 (Default)	A level of 0V selects FX-SD / copper twisted pair for Ports 0 and 1, further determined by FXSDA and FXSDB

Note: The above strap details describe the LAN9252 function. This EVB does not support SFF Fiber Mode. Therefore, FX-SD related straps are not applicable.

2.4.2 LED Indicators

The D3 and D4 LEDs are used to indicate the Link/Activity status on the corresponding EVB ports, as detailed in Table 2-8. The Link/Act LED should be ON at each port when the cable is present. If the Link/Act LED is not ON, it indicates there is an issue with the connection or cable.

TABLE 2-8: D3 AND D4 LINK/ACTIVITY LED STATUS INDICATORS

State	Description
Off	Link is down
Flashing Green	Link is up with activity
Steady Green	Link is up with no activity

Additionally, the D5 LED is used as a RUN indicator (green) to show the AL status of the EtherCAT® State Machine (ESM), as detailed in Table 2-9.

TABLE 2-9: D5 RUN LED STATUS INDICATOR

State	Description
Off	The device is in the INITIALIZATION state
Blinking (on 200ms, off 200ms)	The device is in the PRE-OPERATIONAL state
Single Flash (on 200ms, off 1000ms)	The device is in the SAFE-OPERATIONAL state
On	The device is in the OPERATIONAL state
Flickering (on 50ms, off 50ms)	The device is booting and has not yet entered the INITIALIZATION state, or the device is in the BOOTSTRAP state and firmware download is in progress. (Optional. Off when not implemented.)

2.4.3 EEPROM Switch

The EVB-LAN9252-DIGIO utilizes 0x50 (7-bit) I²C slave addressing. The SW3 switch can be used to select the A0, A1, and A2 address bits, as shown in Figure 2-2 and Table 2-10. The eighth bit of the slave address determines if the master device wants to read or write to the EEPROM (24C512).

FIGURE 2-2: SLAVE ADDRESS ALLOCATION

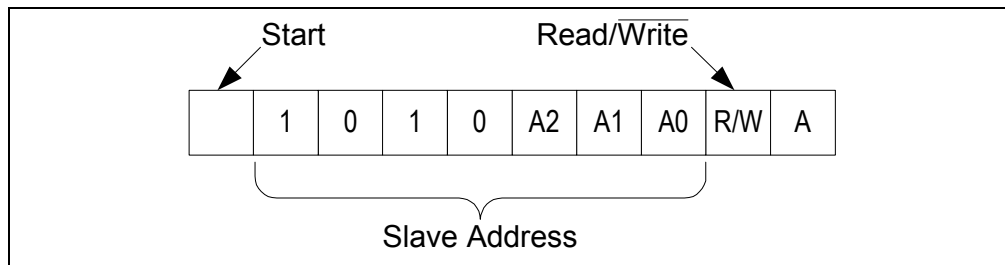

TABLE 2-10: EEPROM SWITCH

Switch	Description	Settings
SW3	I2C EEPROM address selection switch (A0, A1, A2). See Figure 2-2.	ON for logic 0 (default) OFF for logic 1

2.4.4 DIG INPUT Mode

The DIG INPUT Mode can be selected through the headers J10 and J11:

- Logic 1 : (Default) SW4 & SW5 Off position. DIG I/P 0 to 15 tied to pull-up (R98 to R113)
- Logic 0 : The respective knob of 2-way, 8-position dip switch (SW4 & SW5) need to be moved to ON position. Signals can be selected individually.

TABLE 2-11: DIGITAL I/O INPUT MODE SELECTION

Header	Description	Short Pins
J10	Digital Input 0 to 7	1&2, 4&5, 7&8, 10&11, 13&14, 16&17, 19&20, 22&23
J11	Digital Input 8 to 15	1&2, 4&5, 7&8, 10&11, 13&14, 16&17, 19&20, 22&23

2.4.5 DIG OUTPUT Mode

The DIG OUTPUT Mode can be selected through the headers J10 and J11. The updated Digital I/O values can be seen on the LEDs (D6 to D21):

- Logic 1 : LED illuminated
- Logic 0 : LED not illuminated.

Note: LED (D6 to D21) anode connected to ASIC.

TABLE 2-12: DIGITAL I/O OUTPUT MODE SELECTION (DEFAULT MODE)

Header	Description	Short Pins
J10	Digital I/O 0 to 7	2&3, 5&6, 8&9, 11&12, 14&15, 17&18, 20&21, 23&24
J11	Digital I/O 8 to 15	2&3, 5&6, 8&9, 11&12, 14&15, 17&18, 20&21, 23&24

Note: The control signal OE_EXT should be connected high by shorting J12 pins 15 and 16.

2.4.6 DIG Bidirectional Mode

The DIG Bidirectional Mode can be selected by shorting the respective test point pins with the headers J10 and J11, as detailed in Table 2-13. The input and output signal states in this mode are the same as detailed in **Section 2.4.4 “DIG INPUT Mode”** and **Section 2.4.5 “DIG OUTPUT Mode”**.

TABLE 2-13: DIGITAL I/O BIDIRECTIONAL MODE DESCRIPTION

Description	Short Pins
Digital I/O 0 to 7	TP5 & J10.1, TP6 & J10.4, TP7 & J10.7, TP8 & J10.10 TP9 & J10.13, TP10 & J10.16, TP11 & J10.19, TP12 & J10.22, TP13&J10.3, TP14&J10.6, TP15&J10.9, TP16& J10.12, TP17&J10.15, TP18&J10.18, TP19& J10.21, TP20&J10.24
Digital I/O 8 to 15	TP21 & J11.1, TP22 & J11.4, TP23 & J11.7, TP24 & J11.10, TP25 & J11.13, TP26 & J11.16, TP27 & J11.19, TP28 & J11.22, TP29&J11.3, TP30&J11.6, TP31&J11.9, TP32& J11.12, TP33&J11.15, TP34&J11.18,TP35& J11.21, TP36&J11.24

2.4.7 Control Signals

All control signals can be probed and controlled via the J12 header, as shown in Table 2-14.

TABLE 2-14: J12 HEADER CONTROL SIGNAL MAPPING

J12 Pin Number	J12 Signal	J12 Pin Number	J12 Signal
1	3V3	2	3V3
3	WD_STATE	4	GND
5	EOF	6	GND
7	SOF	8	GND
9	LATCH0	10	GND
11	LATCH1	12	GND
13	WD_TRIG	14	GND
15	OE_EXIT	16	3V3
17	OUTVALID	18	GND
19	LATCH_IN	20	GND

Note: J12 pins 15 & 16 must be shorted in output mode.

2.4.7.1 WD_STATE

This pin is the SyncManager Watchdog State output. A “0” indicates the watchdog has expired. The state of this signal can be seen in the LED D22.

Note: This signal is not driven (high impedance) until the EEPROM is loaded.

2.4.7.2 LATCH_IN

This pin is the external data latch signal. The input data is sampled each time a rising edge of LATCH_IN is recognized. By default, this signals is pulled high through R131and can be made low using switch SW6.

2.5 MECHANICALS

FIGURE 2-3: EVB-LAN9252-DIGIO MECHANICAL DIMENSIONS

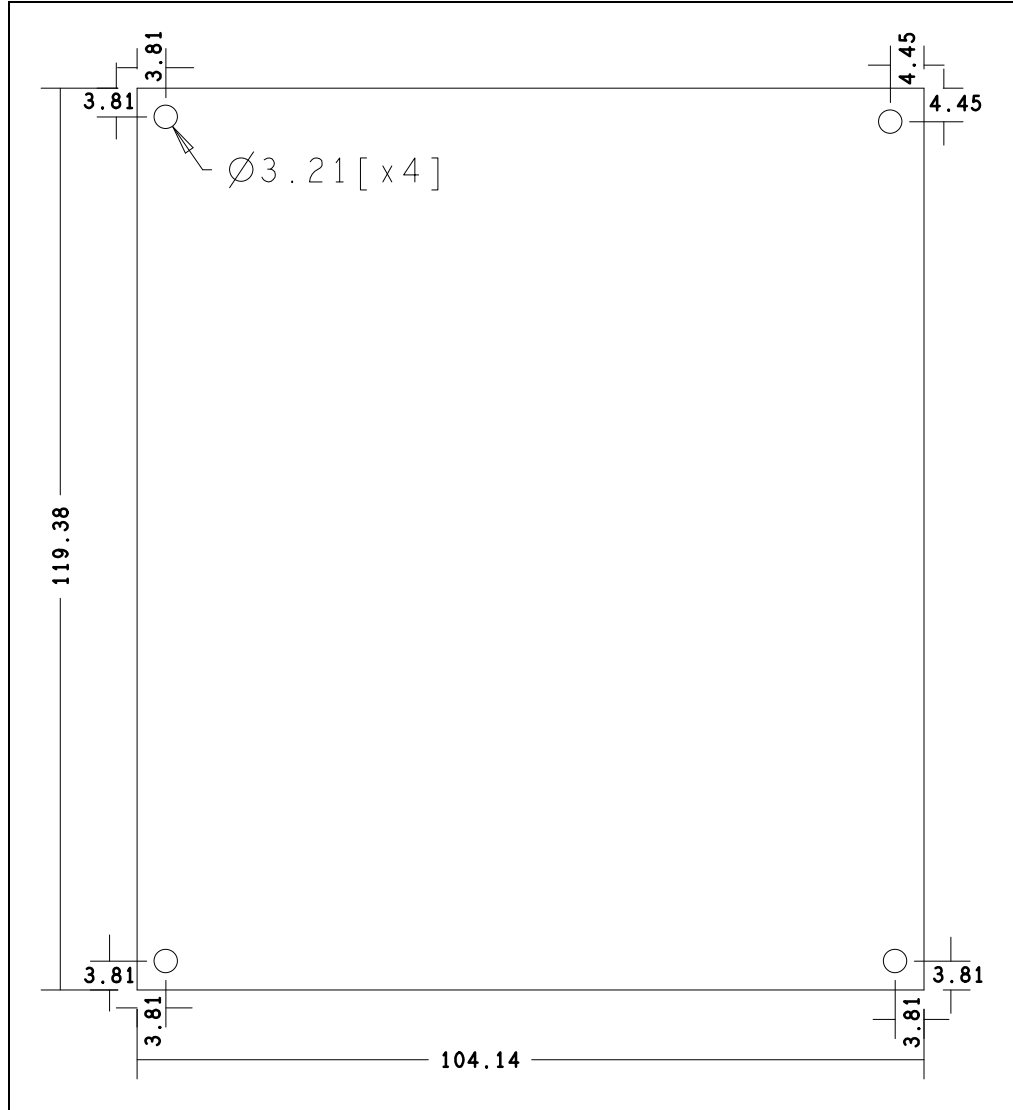

Chapter 3. LAN9252 EEPROM Programming

3.1 PROGRAMMING THE LAN9252 EEPROM

The LAN9252 configures itself to the desired mode (SPI, 6 HBI modes) by reading the strap settings located in EEPROM. The LAN9252 EEPROM is programmed and validated via the TwinCAT master tool. The programming procedure is as follows:

Note 1: This example utilizes the TwinCAT tool. Procedures may differ when using other EtherCAT® master tools.

2: Ensure the system network properties are configured properly for the EtherCAT® frames, Ethernet cable linking your system, and EtherCAT® slave board.

1. Load the corresponding ESI file in the directory path “C:\TwinCAT\Io\EtherCAT”. For this demo, the ESI file for the 16-Bit Multiplexed Single-Phase Mode is used.
2. If TwinCAT installed successfully, a TwinCAT icon will be shown in the bottom-right corner of the desktop. After clicking the icon, a pop-up list will display. Select “System Manager”, as shown in Figure 3-1.

FIGURE 3-1: TWINCAT SYSTEM MANAGER

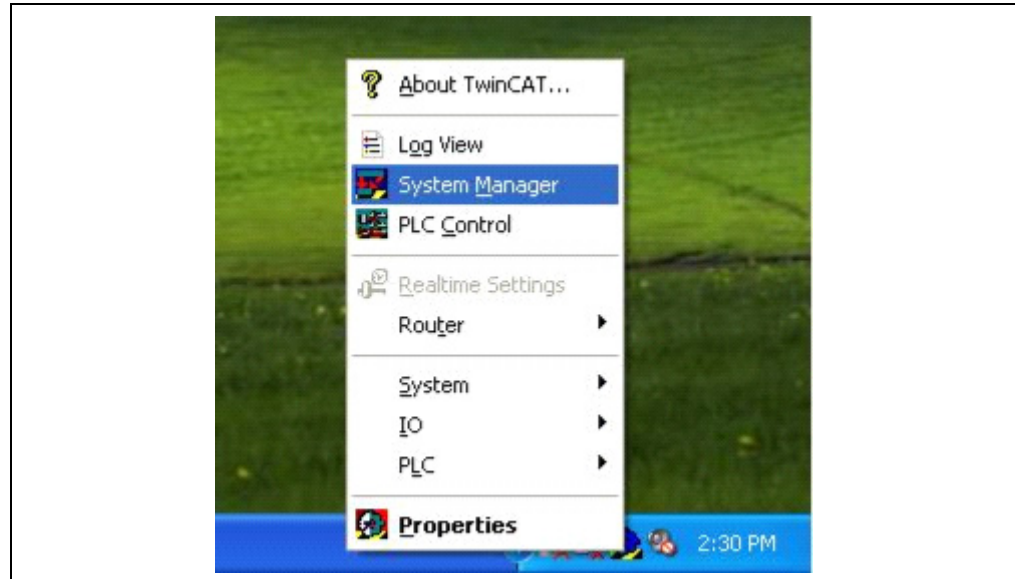

LAN9252 EEPROM Programming

3. If any devices are present, delete them accordingly by clicking the device and selecting “Delete Device”, as shown in Figure 3-2.

FIGURE 3-2: TWINCAT DELETE DEVICE

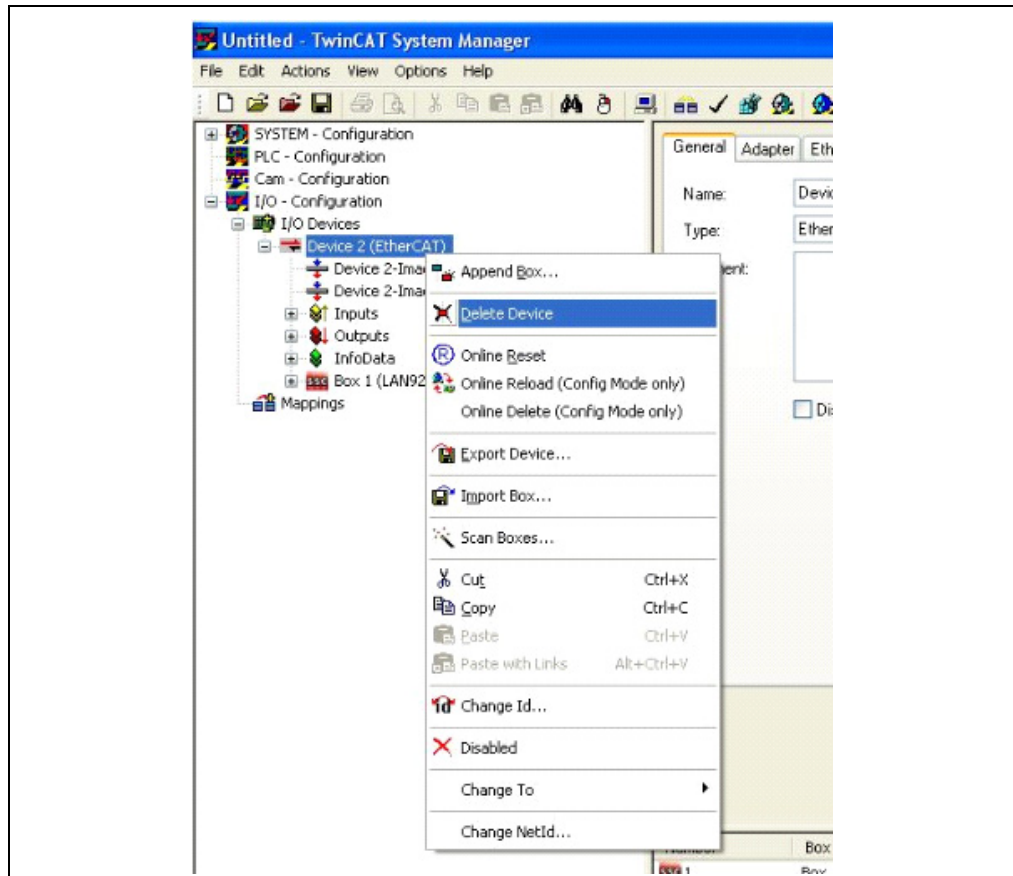

4. Scan for EtherCAT® slave devices by clicking “I/O devices” and selecting “Scan Devices”, as shown in Figure 3-3.

FIGURE 3-3: TWINCAT SCAN DEVICES

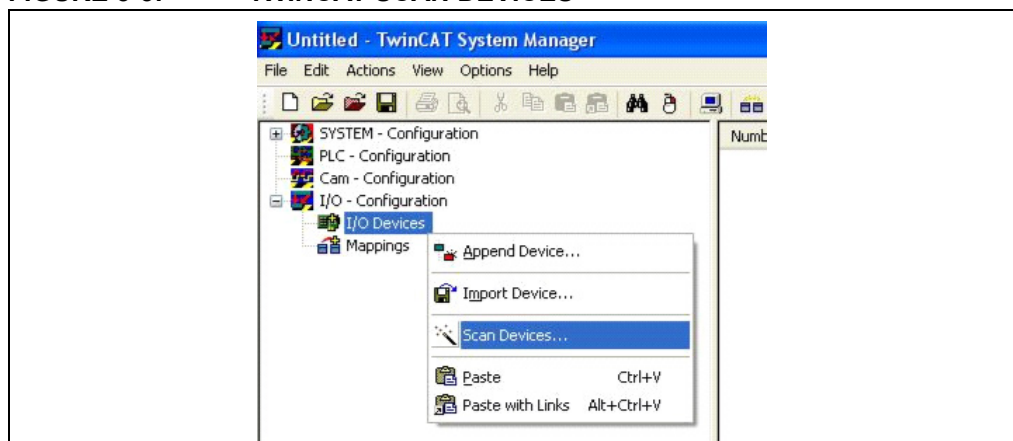

5. After scanning is complete, the right panel of the TwinCAT window will appear as shown in Figure 3-4.

FIGURE 3-4: TWINCAT DEVICE LIST

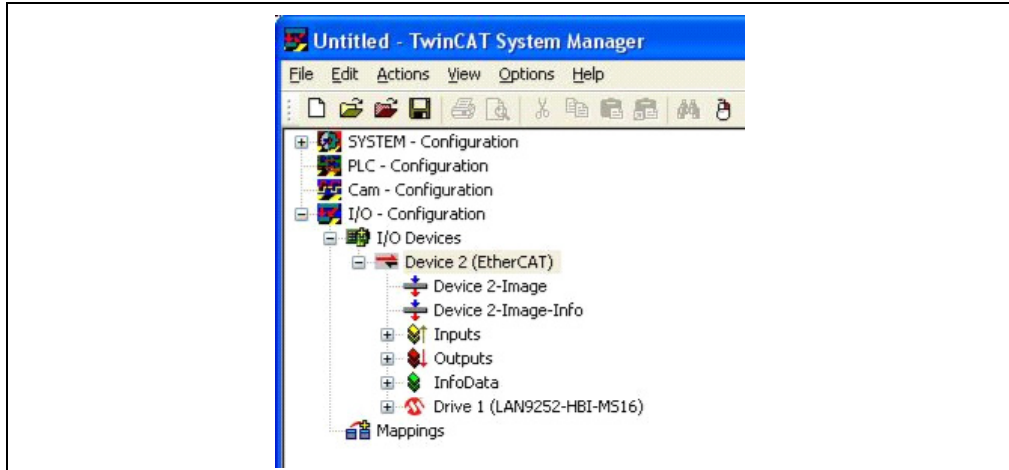

6. After a successful scan, click the “Device 2 (EtherCAT)” drop down bar on the left panel of the TwinCAT tool (as highlighted in Figure 3-4). Then click the “Online” tab on the right-side panel of the TwinCAT tool, as shown in Figure 3-5. Right click the LAN9252 listing and select “EEPROM Update” from the contextual menu.

FIGURE 3-5: TWINCAT EEPROM UPDATE

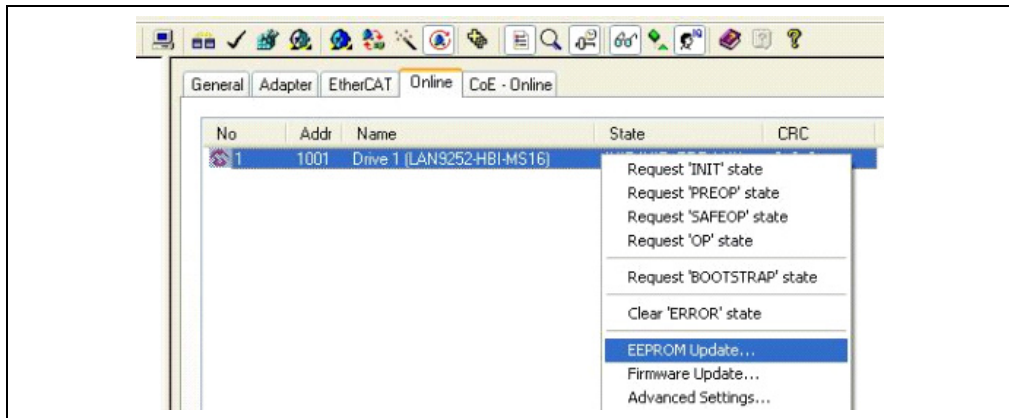

7. Upon selecting “EEPROM Update”, the Write EEPROM window will open. Click the “OK” button to initiate EEPROM programming.

FIGURE 3-6: TWINCAT WRITE EEPROM

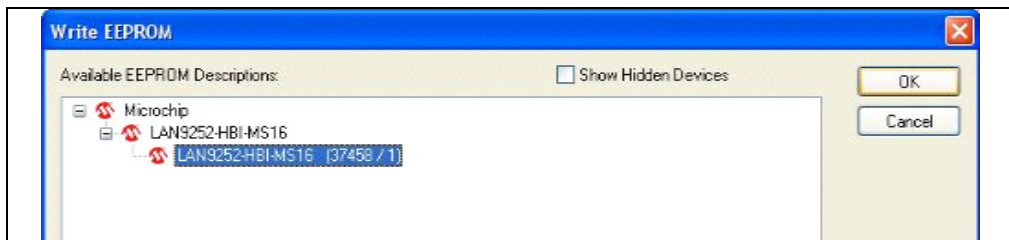

Appendix A. EVB-LAN9252-DIGIO Evaluation Board

A.1 INTRODUCTION

This appendix shows the EVB-LAN9252-DIGIO Evaluation Board.

FIGURE A-1: EVB-LAN9252-DIGIO EVALUATION BOARD

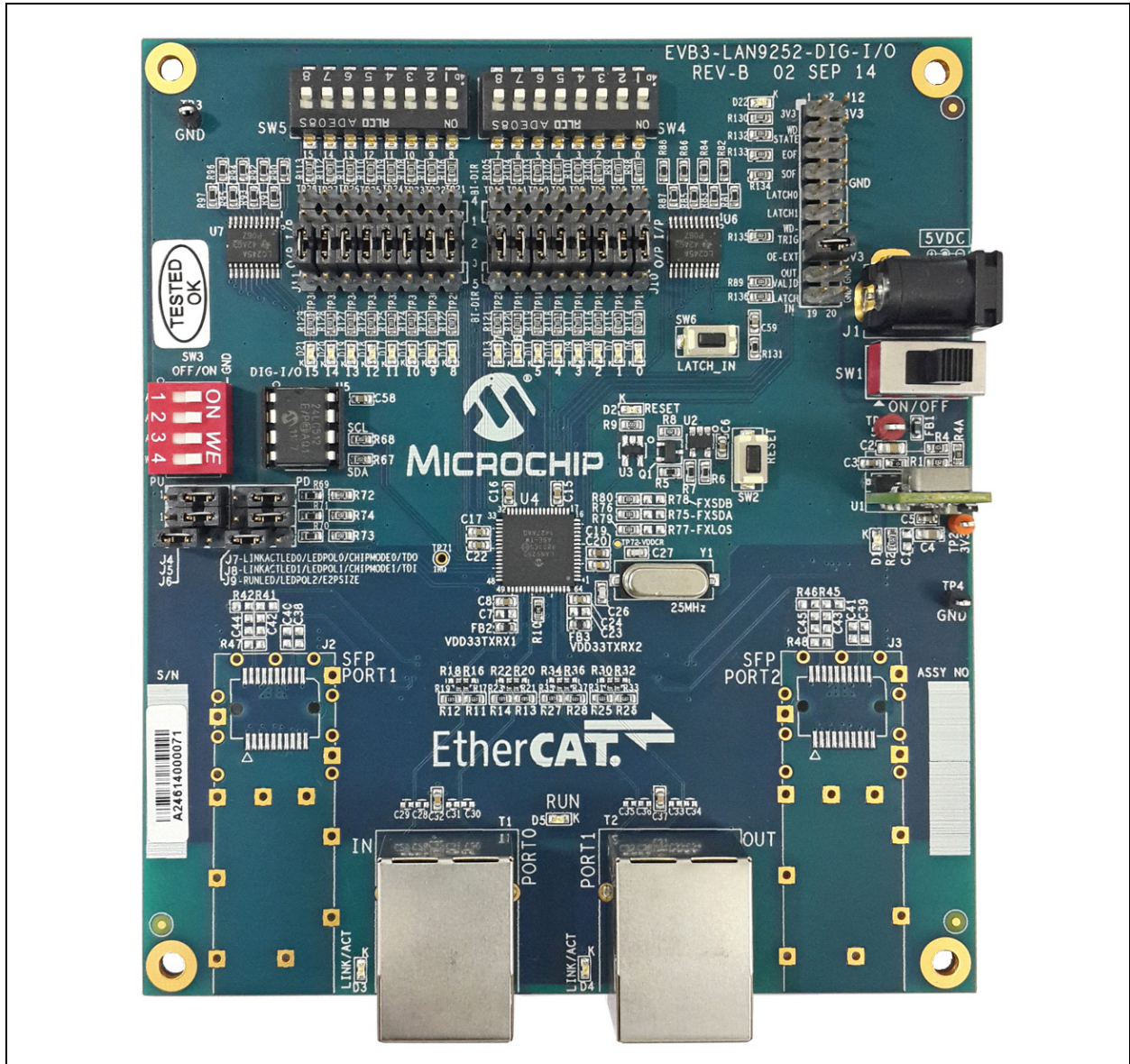



MICROCHIP

**EVB-LAN9252-DIGIO
USER'S GUIDE**

Appendix B. EVB-LAN9252-DIGIO Evaluation Board Schematics

B.1 INTRODUCTION

This appendix shows the EVB-LAN9252-DIGIO Evaluation Board Schematics.

FIGURE B-1: EVB-LAN9252-DIGIO SCHEMATIC POWER SUPPLY & RESET

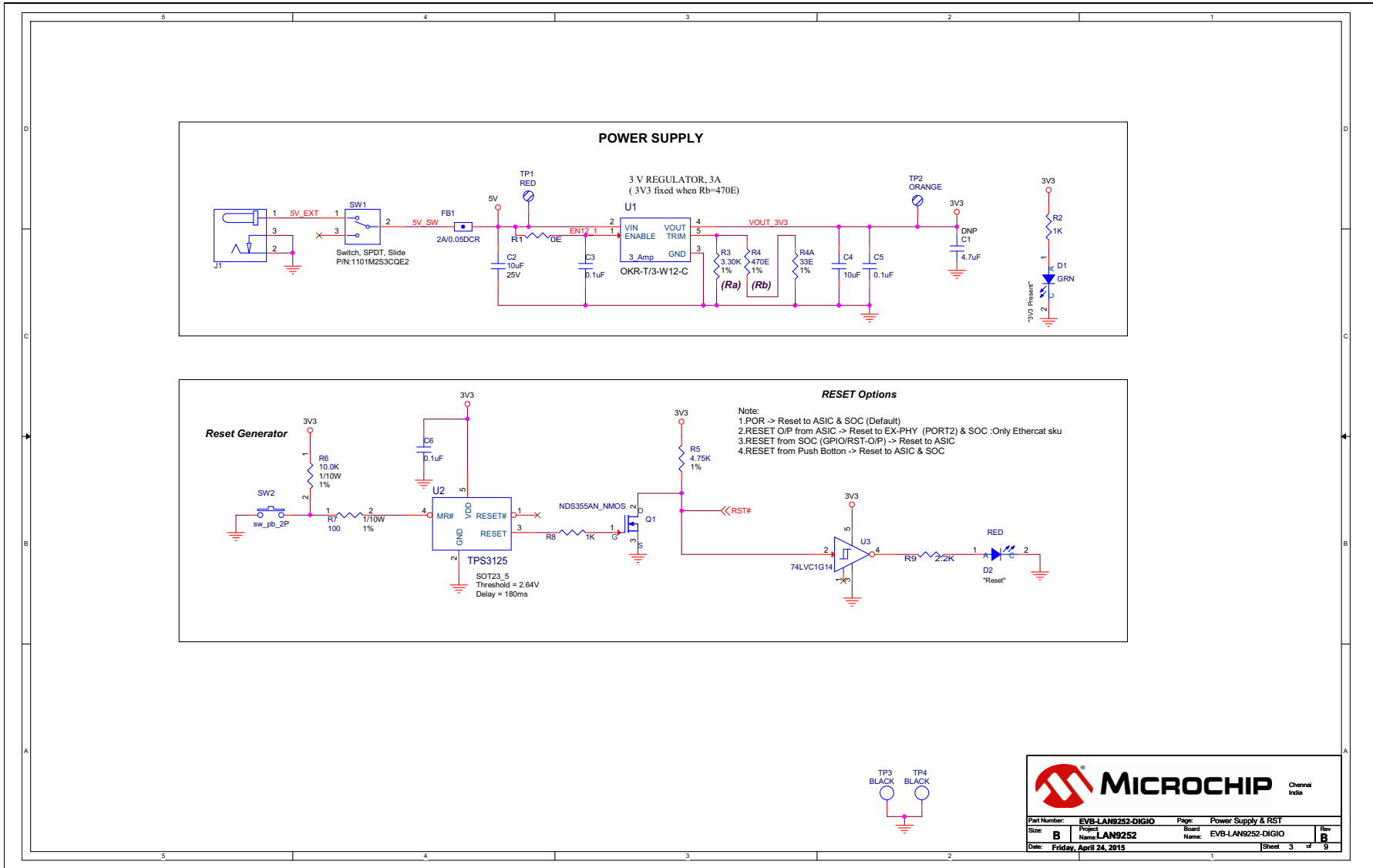

FIGURE B-2: EVB-LAN9252-DIGIO SCHEMATIC LAN9252 PT1

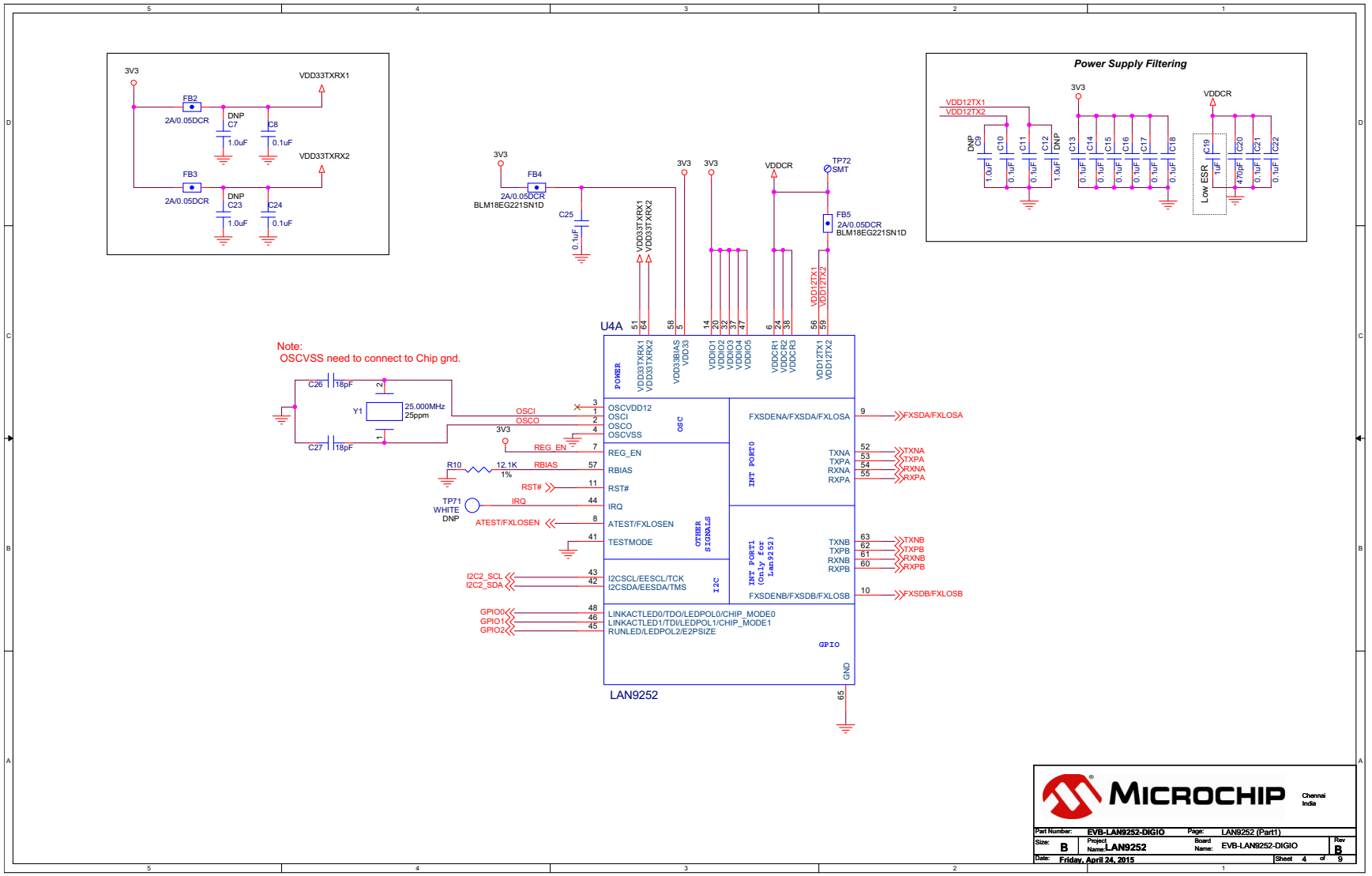
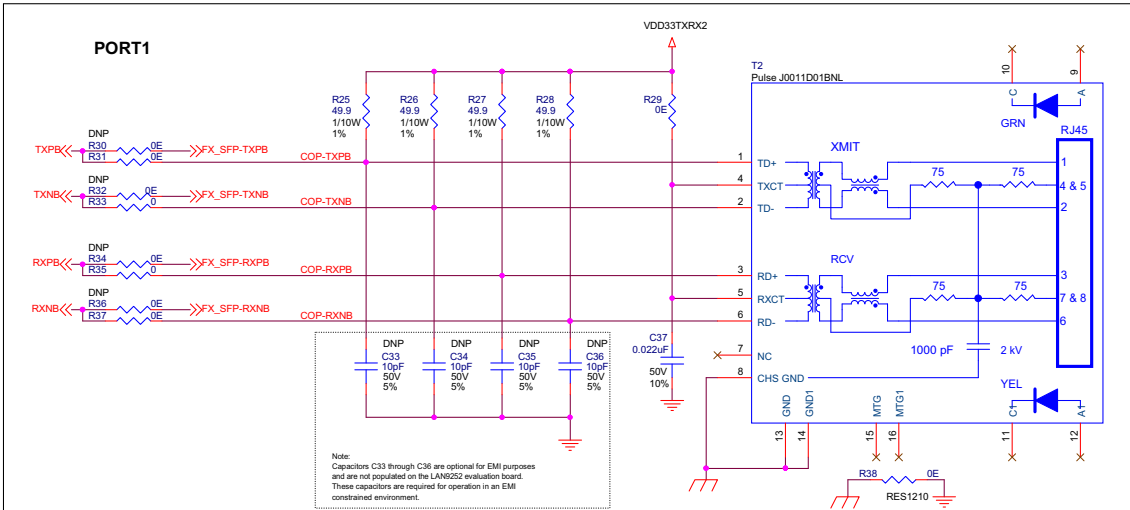
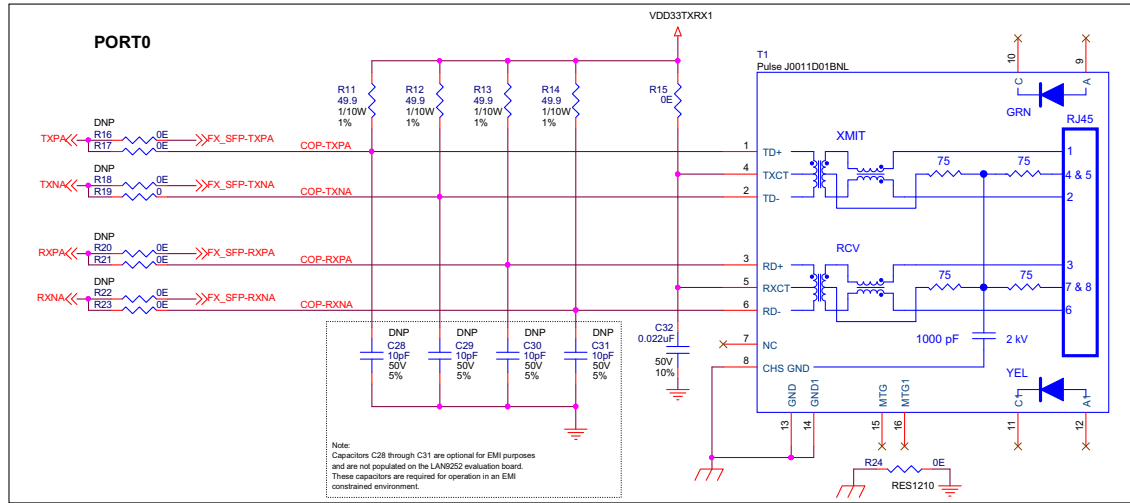

FIGURE B-3: EVB-LAN9252-DIGIO SCHEMATIC COPPER MODE INTERFACE



MICROCHIP Channel India

Part Number:	EVB-LAN9252-DIGIO	Page:	Copper Mode Interface
Size:	B	Project Name:	LAN9252
Date:	Friday, April 24, 2015	Board Name:	EVB-LAN9252-DIGIO
		Sheet	5 of 9

FIGURE B-4: EVB-LAN9252-DIGIO SCHEMATIC SFP INTERFACE

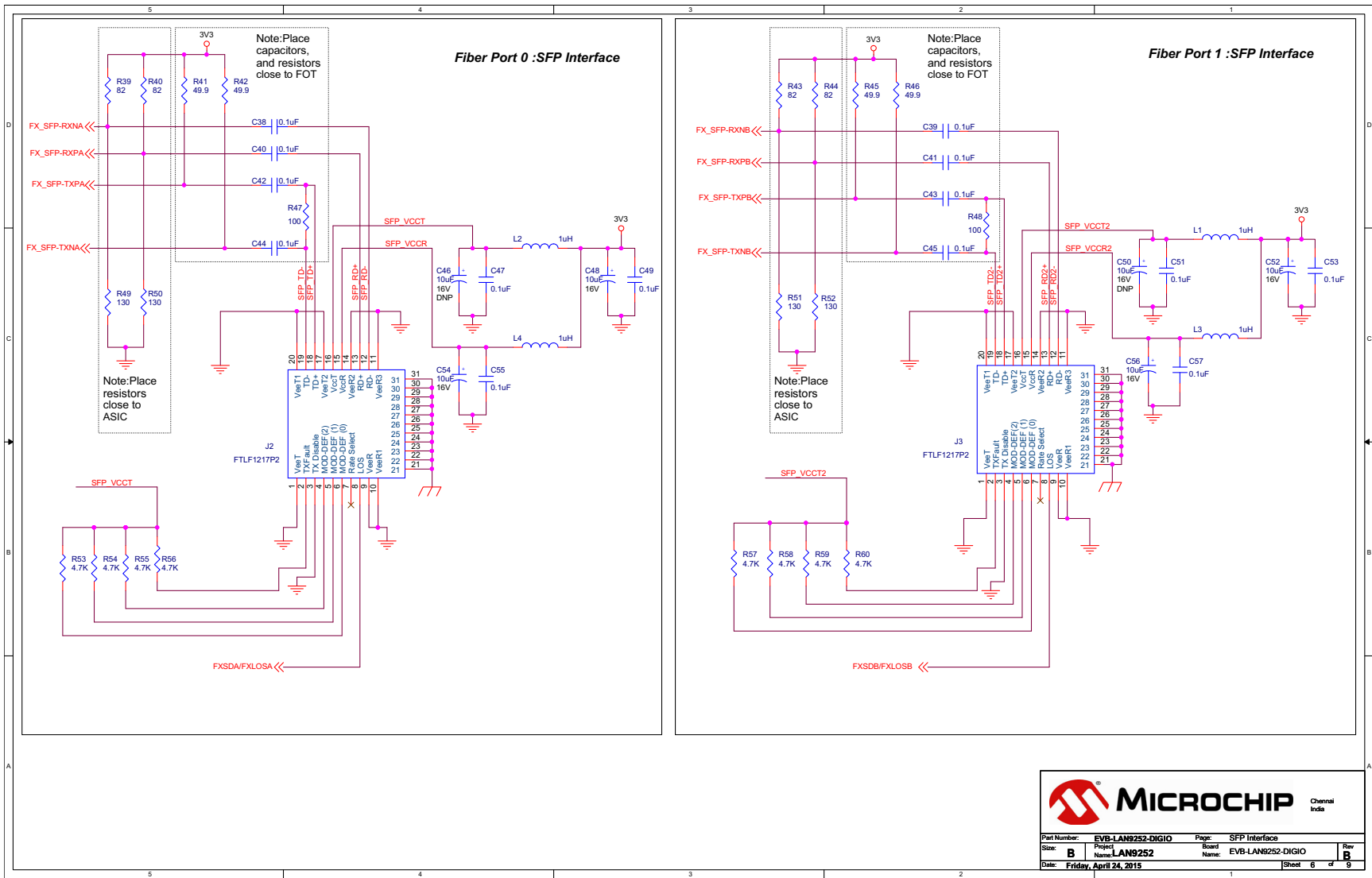

MICROCHIP Chennai India

Part Number:	EVB-LAN9252-DIGIO	Page:	SFP Interface
Size:	B	Project Name:	LAN9252
Date:	Friday, April 24, 2015	Board Name:	EVB-LAN9252-DIGIO
		Rev:	1
		Sheet:	6 of 9

FIGURE B-5: EVB-LAN9252-DIGIO SCHEMATIC STRAP, GPIO, I2C & FXLOS

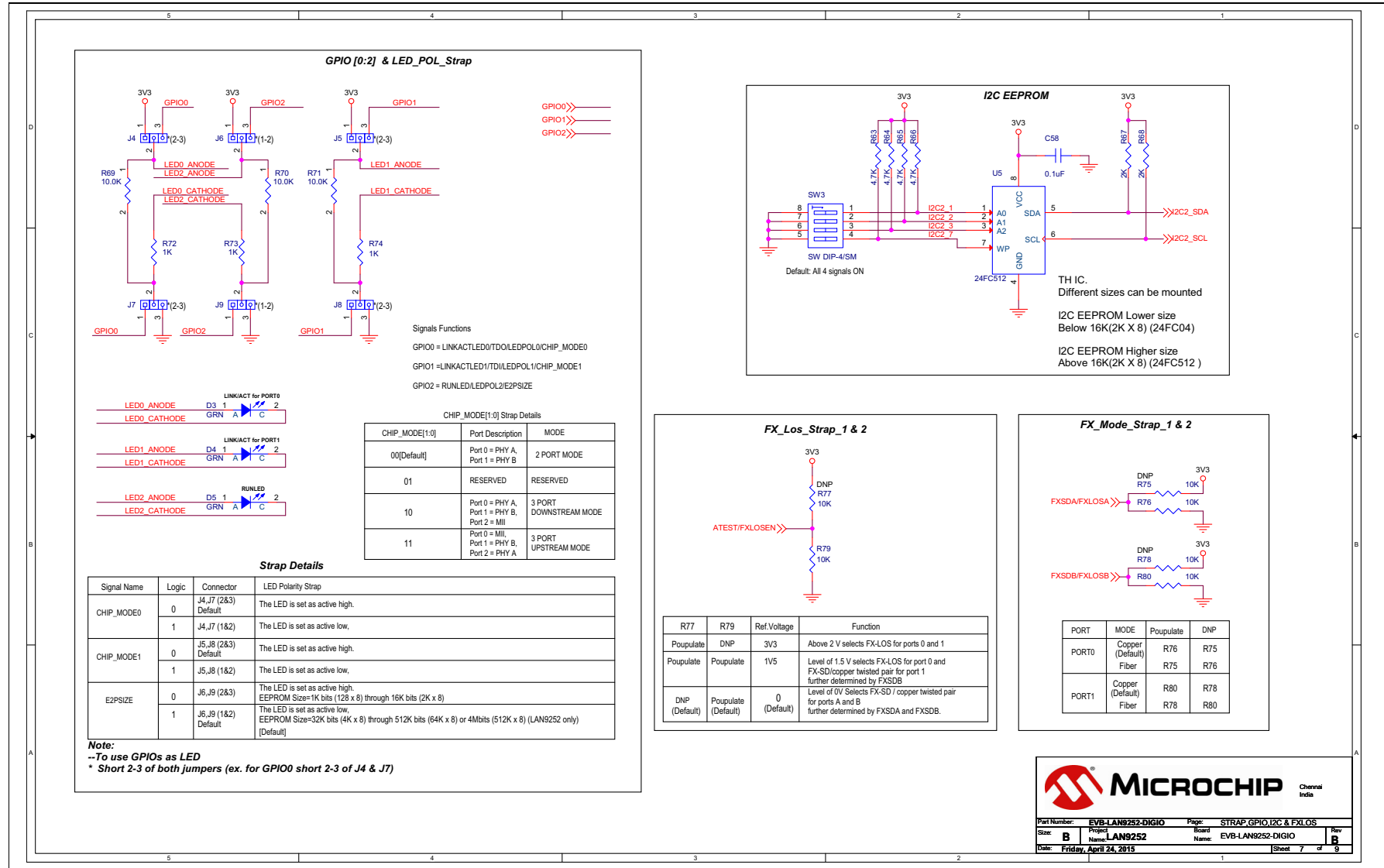

MICROCHIP Channel Inds

Part Number:	EVB-LAN9252-DIGIO	Page:	STRAP,GPIO,I2C & FXLOS
Size:	B	Project Name:	EVB-LAN9252-DIGIO
Date:	Friday, April 24, 2015	Sheet:	7 of 9

FIGURE B-6: EVB-LAN9252-DIGIO SCHEMATIC LAN9252 PT2

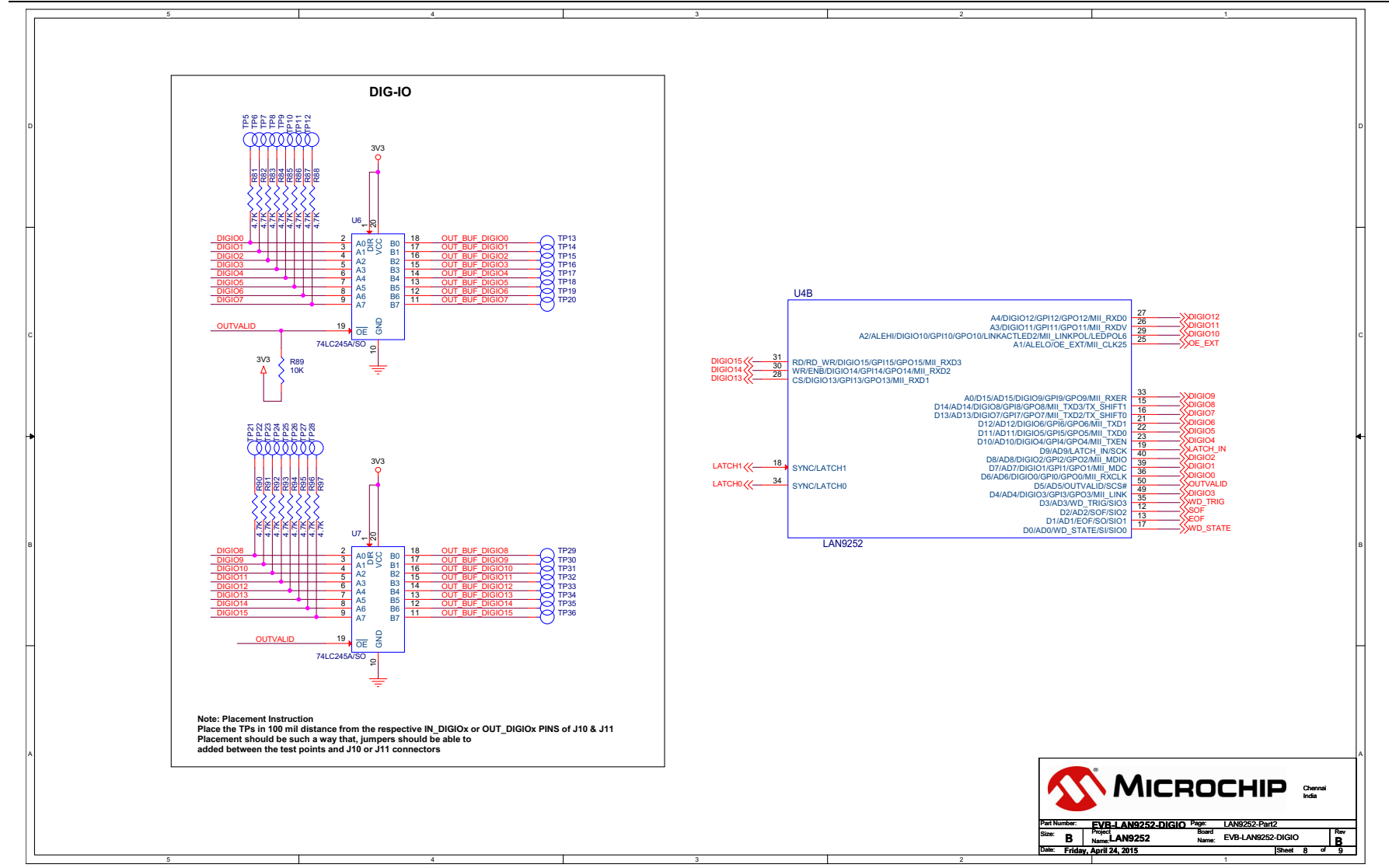
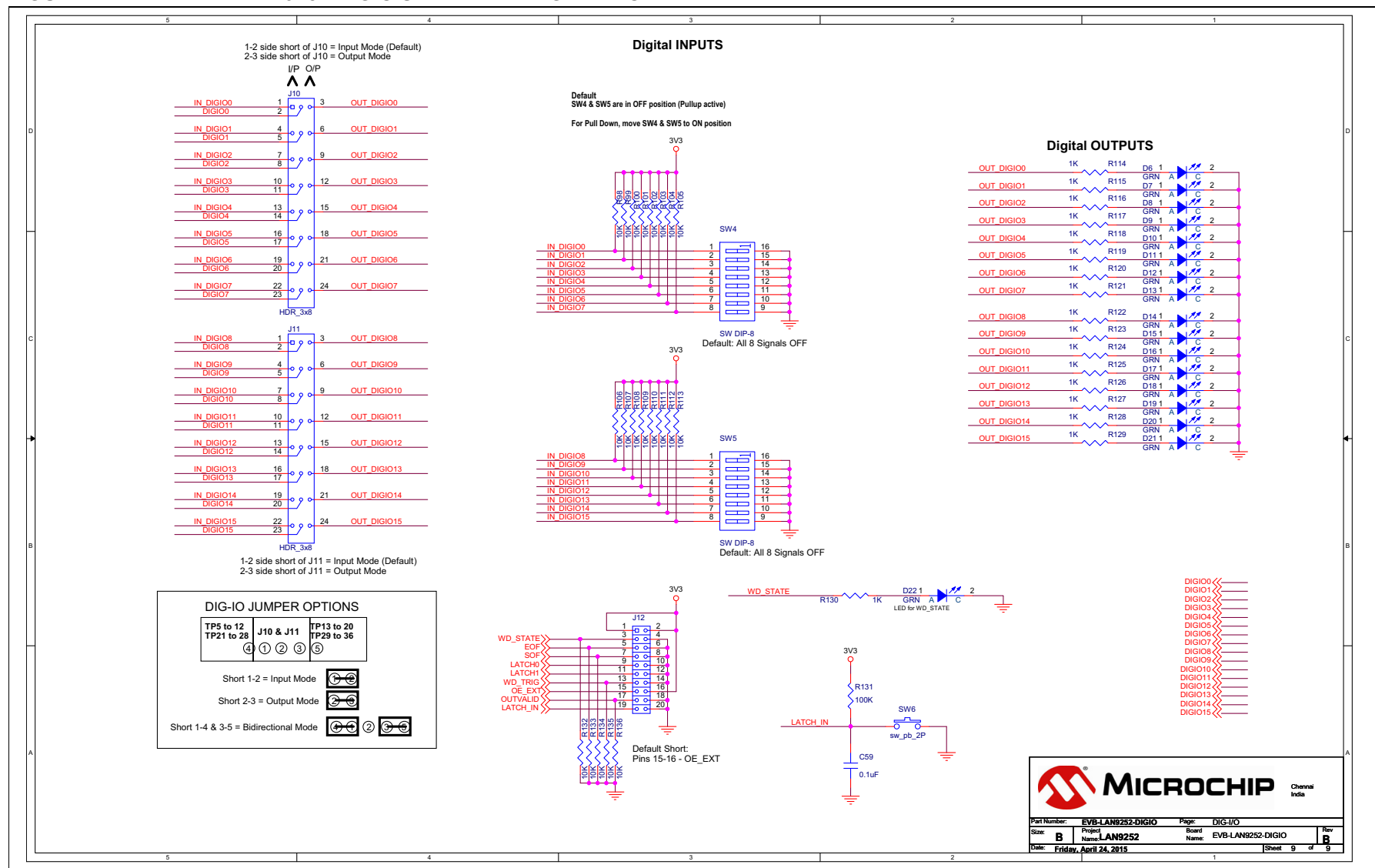

FIGURE B-7: EVB-LAN9252-DIGIO SCHEMATIC DIGITAL I/O



MICROCHIP Channel India

Part Number:	EVB-LAN9252-DIGIO	Page:	DIG-I/O
Size:	B	Project Name:	LAN9252
Date:	Friday, April 24, 2015	Board Name:	EVB-LAN9252-DIGIO
		Rev:	B
		Sheet:	9 of 9



Appendix C. Bill of Materials (BOM)

C.1 INTRODUCTION

This appendix includes the EVB-LAN9252-DIGIO Evaluation Board Bill of Materials (BOM).

Item	Quantity	Reference	Part	PCB Footprint	DNP	Vender	Vender Part NO
1	2	C2,C4	10uF	CAP0805	No	Murata	GRM21BR61E106KA73L
2	18	C3,C5,C6,C8,C10,C11,C13,C14,C15,C16,C17,C18,C21,C22,C24,C25,C58,C59	0.1uF	CAP0603	No	Murata	GRM188R71E104KA01D
3	1	C19	1uF	CAP0603	No	Murata	GRM188R61C105KA93D
4	1	C20	470pF	CAP0603	No	Kemet	C0603C471K3RACTU
5	2	C26,C27	18pF	CAP0603	No	Murata	GRM1885C1H180JA01D
6	2	C32,C37	0.022uF	CAP0603	No	Kemet	C0603C223K5RACTU
7	21	D1,D3,D4,D5,D6,D7,D8,D9,D10,D11,D12,D13,D14,D15,D16,D17,D18,D19,D20,D21,D22	GRN	LED0603	No	Würth electronics	150 060 GS7 500 0
8	1	D2	RED	LED0603	No	Würth electronics	150 060 RS7 500 0
9	5	FB1,FB2,FB3,FB4,FB5	2A/0.05DCR	RES0603	No	Murata	BLM18EG221SN1D
10	1	J1	SKT_PWR_2R0mm_4A_THRU_RA	th_conn_pwrjack_dc-210_rt	No	Cui Stack	PJ-002AH
11	6	J4,J5,J6,J7,J8,J9	HDR_1x3	TH_CONN_1X3P	No	FCI	68000-103HLF
12	2	J10,J11	HDR_3x8	TH_CONN_3x8P	No	FCI	68000-108HLF
13	1	J12	2x10	TH_CONN_2x10P	No	FCI	67997-220HLF
14	1	Q1	NDS355AN_NMOS	sot23-NDS	No	Fairchild	NDS355AN
15	3	R1,R15,R29	0E	RES0603	No	Panasonic	ERJ-3GEY0R00V
16	22	R2,R8,R72,R73,R74,R114,R115,R116,R117,R118,R119,R120,R121,R122,R123,R124,R125,R126,R127,R128,R129,R130	1K	RES0603	No	Panasonic	ERJ-3GEYJ102V
17	1	R3	3.30K	RES0603	No	Yageo America	9C06031A3301FKHFT
18	1	R4	470E	RES0603	No	BOURNS	CR0603-FX-4700ELF
19	1	R4A	33E	RES0603	No	BOURNS	CR0603-FX-33R0ELF
20	1	R5	4.75K	RES0603	No	Panasonic	ERJ-3EKF4751V
21	4	R6,R69,R70,R71	10.0K	RES0603	No	Panasonic	ERJ-3EKF1002V
22	1	R7	100	RES0603	No	Panasonic	ERJ-3EKF1000V
23	1	R9	2.2K	RES0603	No	Panasonic	ERJ-3GEYJ222V
24	1	R10	12.1K	RES0603	No	Rohm	MCR01MZPF1202
25	8	R11,R12,R13,R14,R25,R26,R27,R28	49.9	RES0603	No	Yageo America	9C06031A49R9FKHFT
26	8	R17,R19,R21,R23,R31,R33,R35,R37	0E	RES0402	No	Panasonic	ERJ-2GE0R00X

27	2	R24,R38	0E	RES1210	No	Vishay	CRCW12100000Z0EA
28	2	R67,R68	2K	RES0603	No	Panasonic	ERJ-3GEYJ202V
29	25	R76,R79,R80,R89,R98,R99,R100,R101,R102,R103,R104,R105,R106,R107,R108,R109,R110,R111,R112,R113,R132,R133,R134,R135,R136	10K	RES0603	No	Panasonic	ERJ-3GEYJ103V
30	1	R131	100K	RES0603	No	Panasonic	ERJ-3EKF1003V
31	20	R81,R82,R83,R84,R85,R86,R87,R88,R90,R91,R92,R93,R94,R95,R96,R97,R63,R64,R65,R66	4.7K	RES0603	No	Panasonic	ERJ-3EKF4701V
32	1	SW1	SW-SPDT-SLIDE	sw_ck_1101m2s3cq2	No	C&K	1101M2S3CQE2
33	2	SW2,SW6	sw_pb_2P	sw_pb_2P	No	Panasonic	EVQ-PJU04K
34	1	SW3	SW DIP-4/SM	TH_SW_DIP4	No	Würth electronics	418117270904
35	2	SW4,SW5	SW DIP-8	SW_DIP_SMT_8P-ade08s04	No	TE	1-1825058-9/ade08s04
36	1	TP1	RED	TH_TP_60D40	No	Keystone	5000
37	1	TP2	ORANGE	TH_TP_60D40	No	Keystone	5003
38	2	TP3,TP4	BLACK	TH_TP_60D40	No	Keystone	5001
39	32	TP5,TP6,TP7,TP8,TP9,TP10,TP11,TP12,TP13,TP14,TP15,TP16,TP17,TP18,TP19,TP20,TP21,TP22,TP23,TP24,TP25,TP26,TP27,TP28,TP29,TP30,	WHITE	TH_TP	No	FCI	68000-101HLF
40	2	T1,T2	Pulse - J0011D01BNL	th_conn_pulse_rj45_j0026	No	Pulse Electronics	J0011D01BNL
41	1	U1	3_Amp	TH_DC-DC_VERT_5PIN_P67	No	Murata	OKR-T/3-W12-C
42	1	U2	TPS3125	SOT23_5	No	TI	TPS3125L30DBVR
43	1	U3	74LVC1G14	SOT23_5	No	TI	SN74LVC1G14DBVR
44	1	U4	LAN9252	IC_QFN64	No	Microchip	LAN9252
45	1	U5	24FC512	IC_DIP8_300	No	Microchip	24FC512-I/P
46	2	U6,U7	74LC245A/SO	IC_SO20-MO-153	No	TI	SN74LVC245APWR
47	1	Y1	25.000MHz	XTAL_HCM49	No	Cardinal Components Inc.	CSM1Z-A5B2C5-40-25.0D18-F

Do NOT Populate components:							
Item	Quantity	Reference	Part	PCB Footprint	DNP	Vender	Vender Part NO
1	1	C1	4.7uF	CAP0603	DNP	Murata	GRM188R60J475KE19D
2	4	C7,C9,C12,C23	1.0uF	CAP0603	DNP	Murata	GRM188R61C105KA93D
3	8	C28,C29,C30,C31,C33,C34,C35,C36	10pF	CAP0402	DNP	Murata	GRM1885C1H100JA01D
4	14	C38,C39,C40,C41,C42,C43,C44,C45,C47,C49, C51,C53,C55,C57	0.1uF	CAP0603	DNP	Murata	GRM188R71E104KA01D
5	6	C46,C48,C50,C52,C54,C56	10uF	CAP_B_3528	DNP	Kemet	B45190E3106K209
6	2	J2,J3	FTLF1217P2	CONN_FX_SFP_FTLF1217P2	DNP	Finisar	775-1011-ND
7	4	L1,L2,L3,L4	1uH	L0805	DNP		
8	8	R16,R18,R20,R22,R30,R32,R34,R36	0	RES0402	DNP		
9	4	R39,R40,R43,R44	82	RES0603	DNP	Panasonic	ERJ-3EKF1300V
10	4	R41,R42,R45,R46	49.9	RES0603	DNP	Yageo America	9C06031A49R9FKHFT
11	2	R47,R48	100	RES0603	DNP	Panasonic	ERJ-3EKF1000V
12	4	R49,R50,R51,R52	130	RES0603	DNP	Panasonic	ERJ-3EKF1300V
13	8	R53,R54,R55,R56,R57,R58,R59,R60	4.7K	RES0603	DNP	Panasonic	ERJ-3EKF4701V
14	3	R75,R77,R78	10K	RES0603	DNP	Panasonic	ERJ-3GEYJ103V
15	1	TP71	WHITE	TH_TP_60D40	DNP	Keystone	5002
16	1	TP72	SMT	tp-smd40	DNP	NA	NA



MICROCHIP

Worldwide Sales and Service

AMERICAS

Corporate Office
2355 West Chandler Blvd.
Chandler, AZ 85224-6199
Tel: 480-792-7200
Fax: 480-792-7277
Technical Support:
<http://www.microchip.com/support>
Web Address:
www.microchip.com

Atlanta
Duluth, GA
Tel: 678-957-9614
Fax: 678-957-1455

Austin, TX
Tel: 512-257-3370

Boston
Westborough, MA
Tel: 774-760-0087
Fax: 774-760-0088

Chicago
Itasca, IL
Tel: 630-285-0071
Fax: 630-285-0075

Cleveland
Independence, OH
Tel: 216-447-0464
Fax: 216-447-0643

Dallas
Addison, TX
Tel: 972-818-7423
Fax: 972-818-2924

Detroit
Novi, MI
Tel: 248-848-4000

Houston, TX
Tel: 281-894-5983

Indianapolis
Noblesville, IN
Tel: 317-773-8323
Fax: 317-773-5453

Los Angeles
Mission Viejo, CA
Tel: 949-462-9523
Fax: 949-462-9608

New York, NY
Tel: 631-435-6000

San Jose, CA
Tel: 408-735-9110

Canada - Toronto
Tel: 905-673-0699
Fax: 905-673-6509

ASIA/PACIFIC

Asia Pacific Office
Suites 3707-14, 37th Floor
Tower 6, The Gateway
Harbour City, Kowloon
Hong Kong
Tel: 852-2943-5100
Fax: 852-2401-3431

Australia - Sydney
Tel: 61-2-9868-6733
Fax: 61-2-9868-6755

China - Beijing
Tel: 86-10-8569-7000
Fax: 86-10-8528-2104

China - Chengdu
Tel: 86-28-8665-5511
Fax: 86-28-8665-7889

China - Chongqing
Tel: 86-23-8980-9588
Fax: 86-23-8980-9500

China - Dongguan
Tel: 86-769-8702-9880

China - Hangzhou
Tel: 86-571-8792-8115
Fax: 86-571-8792-8116

China - Hong Kong SAR
Tel: 852-2943-5100
Fax: 852-2401-3431

China - Nanjing
Tel: 86-25-8473-2460
Fax: 86-25-8473-2470

China - Qingdao
Tel: 86-532-8502-7355
Fax: 86-532-8502-7205

China - Shanghai
Tel: 86-21-5407-5533
Fax: 86-21-5407-5066

China - Shenyang
Tel: 86-24-2334-2829
Fax: 86-24-2334-2393

China - Shenzhen
Tel: 86-755-8864-2200
Fax: 86-755-8203-1760

China - Wuhan
Tel: 86-27-5980-5300
Fax: 86-27-5980-5118

China - Xian
Tel: 86-29-8833-7252
Fax: 86-29-8833-7256

ASIA/PACIFIC

China - Xiamen
Tel: 86-592-2388138
Fax: 86-592-2388130

China - Zhuhai
Tel: 86-756-3210040
Fax: 86-756-3210049

India - Bangalore
Tel: 91-80-3090-4444
Fax: 91-80-3090-4123

India - New Delhi
Tel: 91-11-4160-8631
Fax: 91-11-4160-8632

India - Pune
Tel: 91-20-3019-1500

Japan - Osaka
Tel: 81-6-6152-7160
Fax: 81-6-6152-9310

Japan - Tokyo
Tel: 81-3-6880-3770
Fax: 81-3-6880-3771

Korea - Daegu
Tel: 82-53-744-4301
Fax: 82-53-744-4302

Korea - Seoul
Tel: 82-2-554-7200
Fax: 82-2-558-5932 or
82-2-558-5934

Malaysia - Kuala Lumpur
Tel: 60-3-6201-9857
Fax: 60-3-6201-9859

Malaysia - Penang
Tel: 60-4-227-8870
Fax: 60-4-227-4068

Philippines - Manila
Tel: 63-2-634-9065
Fax: 63-2-634-9069

Singapore
Tel: 65-6334-8870
Fax: 65-6334-8850

Taiwan - Hsin Chu
Tel: 886-3-5778-366
Fax: 886-3-5770-955

Taiwan - Kaohsiung
Tel: 886-7-213-7828

Taiwan - Taipei
Tel: 886-2-2508-8600
Fax: 886-2-2508-0102

Thailand - Bangkok
Tel: 66-2-694-1351
Fax: 66-2-694-1350

EUROPE

Austria - Wels
Tel: 43-7242-2244-39
Fax: 43-7242-2244-393

Denmark - Copenhagen
Tel: 45-4450-2828
Fax: 45-4485-2829

France - Paris
Tel: 33-1-69-53-63-20
Fax: 33-1-69-30-90-79

Germany - Dusseldorf
Tel: 49-2129-3766400

Germany - Munich
Tel: 49-89-627-144-0
Fax: 49-89-627-144-44

Germany - Pforzheim
Tel: 49-7231-424750

Italy - Milan
Tel: 39-0331-742611
Fax: 39-0331-466781

Italy - Venice
Tel: 39-049-7625286

Netherlands - Drunen
Tel: 31-416-690399
Fax: 31-416-690340

Poland - Warsaw
Tel: 48-22-3325737

Spain - Madrid
Tel: 34-91-708-08-90
Fax: 34-91-708-08-91

Sweden - Stockholm
Tel: 46-8-5090-4654

UK - Wokingham
Tel: 44-118-921-5800
Fax: 44-118-921-5820

01/27/15

Mouser Electronics

Authorized Distributor

Click to View Pricing, Inventory, Delivery & Lifecycle Information:

[Microchip:](#)

[EVB-LAN9252-DIGIO](#)

Данный компонент на территории Российской Федерации

Вы можете приобрести в компании MosChip.

Для оперативного оформления запроса Вам необходимо перейти по данной ссылке:

<http://moschip.ru/get-element>

Вы можете разместить у нас заказ для любого Вашего проекта, будь то серийное производство или разработка единичного прибора.

В нашем ассортименте представлены ведущие мировые производители активных и пассивных электронных компонентов.

Нашей специализацией является поставка электронной компонентной базы двойного назначения, продукции таких производителей как XILINX, Intel (ex.ALTERA), Vicor, Microchip, Texas Instruments, Analog Devices, Mini-Circuits, Amphenol, Glenair.

Сотрудничество с глобальными дистрибьюторами электронных компонентов, предоставляет возможность заказывать и получать с международных складов практически любой перечень компонентов в оптимальные для Вас сроки.

На всех этапах разработки и производства наши партнеры могут получить квалифицированную поддержку опытных инженеров.

Система менеджмента качества компании отвечает требованиям в соответствии с ГОСТ Р ИСО 9001, ГОСТ РВ 0015-002 и ЭС РД 009

Офис по работе с юридическими лицами:

105318, г.Москва, ул.Щербаковская д.3, офис 1107, 1118, ДЦ «Щербаковский»

Телефон: +7 495 668-12-70 (многоканальный)

Факс: +7 495 668-12-70 (доб.304)

E-mail: info@moschip.ru

Skype отдела продаж:

moschip.ru

moschip.ru_4

moschip.ru_6

moschip.ru_9