

Wire Wound Common Mode Choke for HDMI

ACM-21H



RoHS/RoHS II compliant



2.0 x 1.2 x 1.2mm

FEATURES:

- Small size and low profile
- Virtually no effect on high speed signals due to suppressed differential mode impedance
- Elimination of common mode noise in high speed, differential mode signal transmission lines such as HDMI

APPLICATIONS:

- HDMI, DVI, etc

STANDARD SPECIFICATIONS

Abracon P/N:	ACM-21H
Operating Temperature & Humidity:	-40°C to +85°C
Storage Temperature & Humidity:	-10°C to +40°C, Humidity < 70%RH (In tape and reel)

Part Number	Impedance @100MHz	DCR	I _R	Rated Voltage	Insulation Resistance
Units	Ω ± 25%	Ω (max.)	mA	Vdc	MΩ (min.)
ACM-21H-670	67	0.30	320	20	10
ACM-21H-900	90	0.40	280	20	10
ACM-21H-121	120	0.40	280	20	10

Test Conditions

Impedance (Common mode and differential mode): LCR Meter Agilent 4287A/E4991A

DCR: Agilent 4338B/34420

I_R: Electric power, Electrical current meter, Thermometer

Definition of Rated Current (I_R): The direct electric current as chip surface temperature rise just 20°C against chip initial surface temperature.

Insertion Loss: Network Analyzer Agilent E5071C

Insulation Resistance: High resistance meter Agilent 4339B

PART IDENTIFICATION:

ACM-21H- -



Impedance Code

Please refer to the table above

Packaging

Blank: bulk
T: Tape and Reel (2k pcs/reel)

Wire Wound Common Mode Choke for HDMI

ACM-21H



RoHS/RoHS II compliant



2.0 x 1.2 x 1.2mm

ELECTRICAL CHARACTERISTIC CURVE:

Impedance vs. Frequency

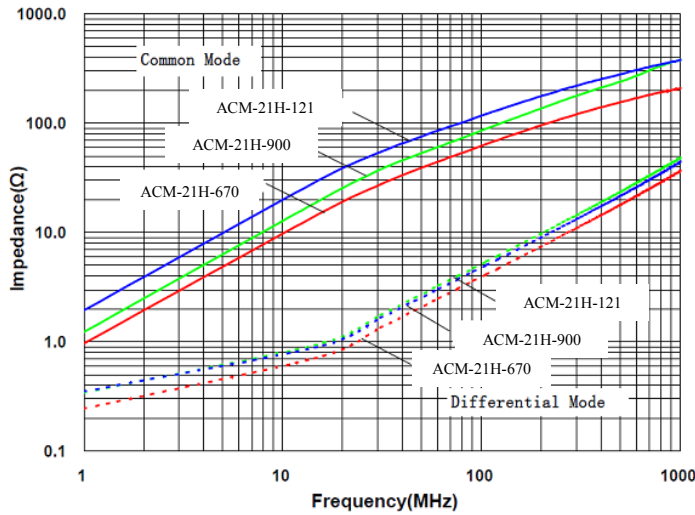

Insertion Loss

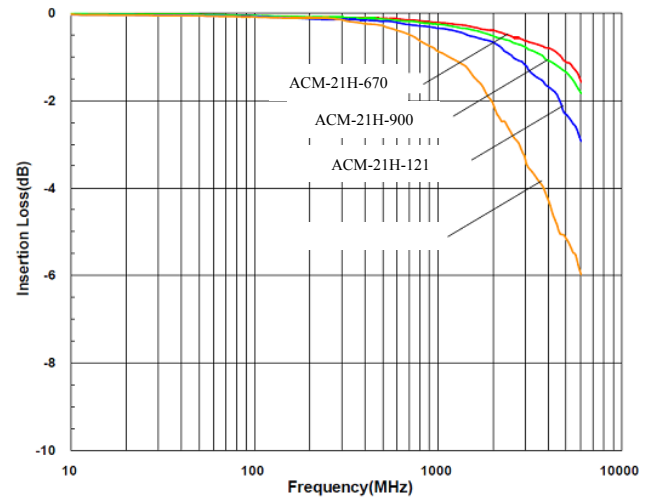

Characteristic Impedance

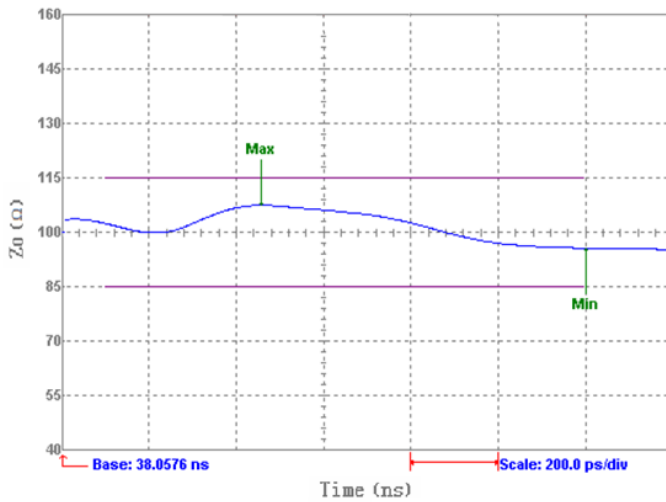

Eye Diagram

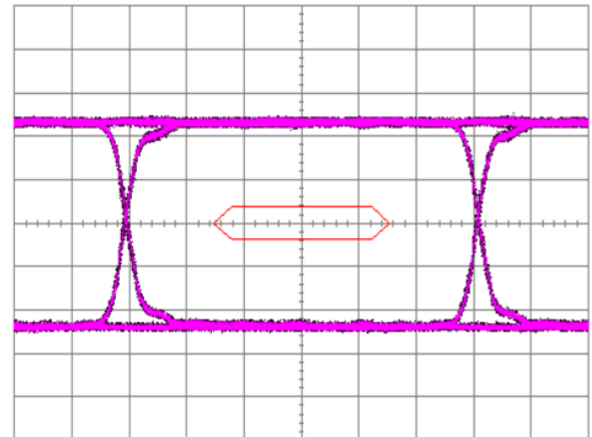

Wire Wound Common Mode Choke for HDMI

ACM-21H



RoHS/RoHS II compliant



2.0 x 1.2 x 1.2mm

OUTLINE DIMENSIONS:

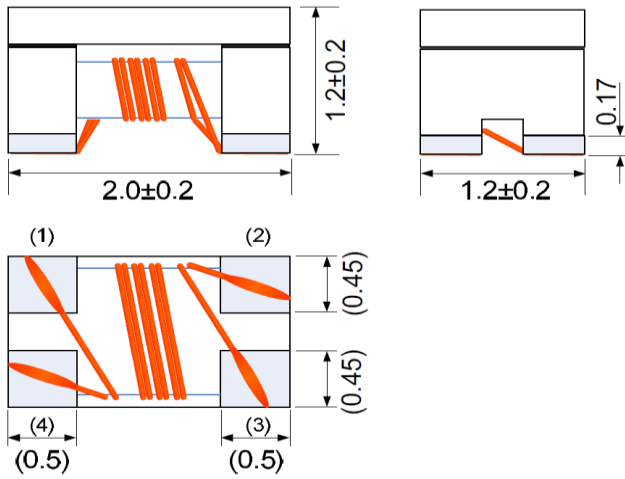

Recommended Land Pattern

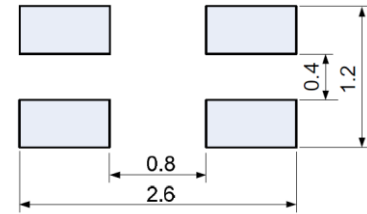

Schematic

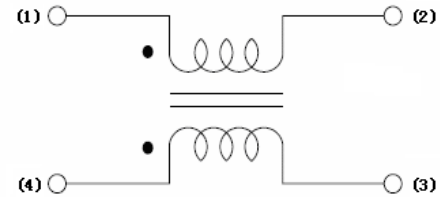

Materials

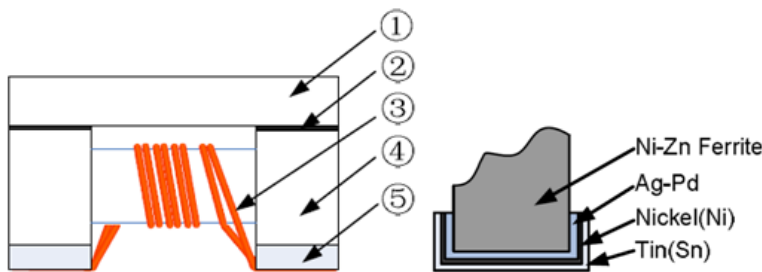

No.	Part Name	Material Name
①	Lid	Ni-Zn Ferrite
②	Epoxy	Epoxy resin
③	Wire	Polyurethane system enameled copper wire
④	Core	Ni-Zn Ferrite
⑤	Electrode structure	(Ag-Pd)+Ni+Sn plating

REFLOW PROFILE:

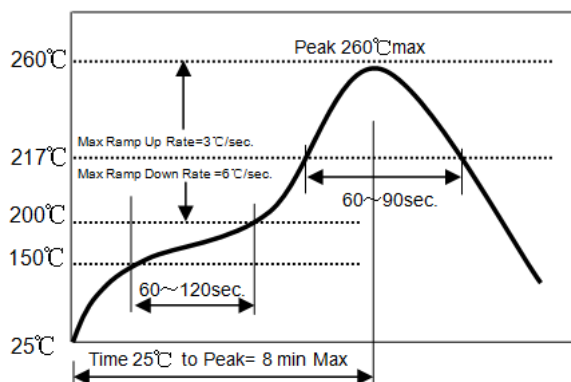

- △ Preheat condition: $150 \sim 200^{\circ}\text{C} / 60 \sim 120$ sec.
- △ Allowed time above 217°C : $60 \sim 90$ sec.
- △ Max temp: 260°C
- △ Max time at max temp: 10 sec.
- △ Solder paste: Sn/3.0Ag/0.5Cu
- △ Allowed Reflow time: 2 times max.

ABRACON IS
ISO 9001:2008
CERTIFIED



Visit www.abracon.com for Terms & Conditions of Sale
30332 Esperanza, Rancho Santa Margarita, California 92688
tel 949-546-8000 | fax 949-546-8001 | www.abracon.com

Revised: 02.19.14

Wire Wound Common Mode Choke for HDMI

ACM-21H



RoHS/RoHS II compliant



2.0 x 1.2 x 1.2mm

TAPE & REEL: 2000pcs/reel

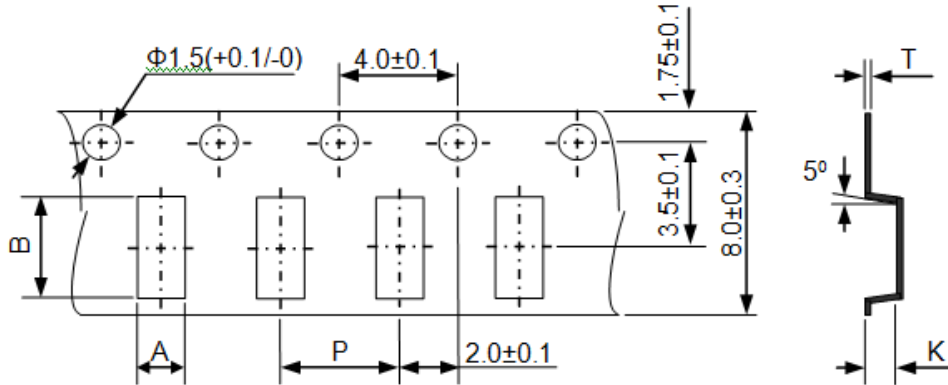

A	B	P	K	T
1.55 ± 0.2	2.25 ± 0.2	4.0 ± 0.1	1.45 ± 0.1	0.2 ± 0.1

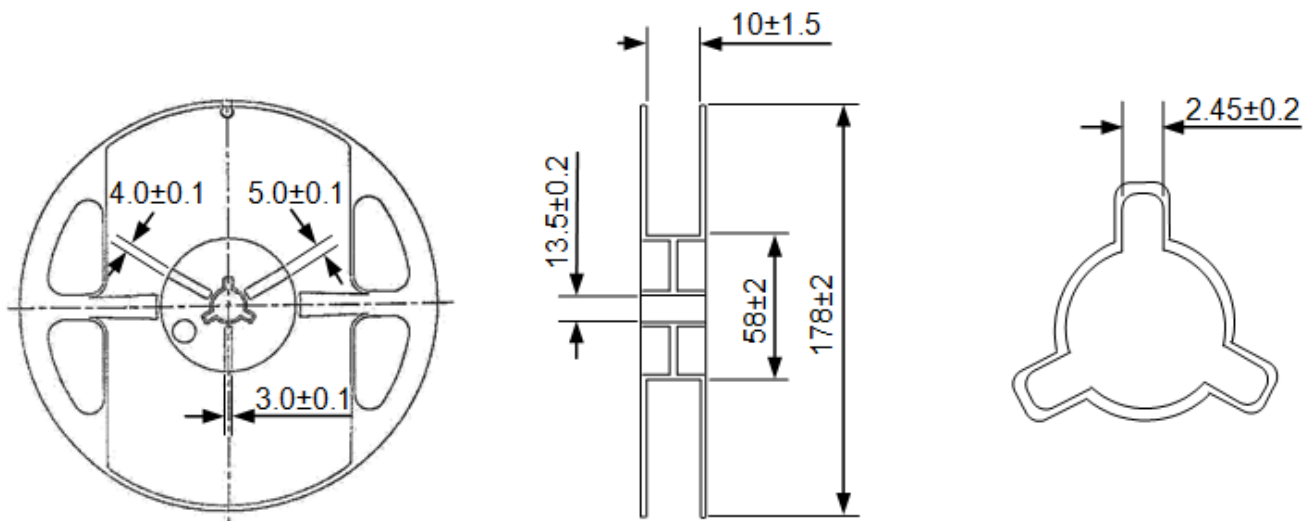

Dimension: mm

ATTENTION: Abracon Corporation's products are COTS – Commercial-Off-The-Shelf products; suitable for Commercial, Industrial and, where designated, Automotive Applications. Abracon's products are not specifically designed for Military, Aviation, Aerospace, Life-dependant Medical applications or any application requiring high reliability where component failure could result in loss of life and/or property. For applications requiring high reliability and/or presenting an extreme operating environment, written consent and authorization from Abracon Corporation is required. Please contact Abracon Corporation for more information.

ABRACON IS
ISO 9001:2008
CERTIFIED



Visit www.abracon.com for Terms & Conditions of Sale **Revised: 02.19.14**
30332 Esperanza, Rancho Santa Margarita, California 92688
tel 949-546-8000 | fax 949-546-8001 | www.abracon.com

Данный компонент на территории Российской Федерации

Вы можете приобрести в компании MosChip.

Для оперативного оформления запроса Вам необходимо перейти по данной ссылке:

<http://moschip.ru/get-element>

Вы можете разместить у нас заказ для любого Вашего проекта, будь то серийное производство или разработка единичного прибора.

В нашем ассортименте представлены ведущие мировые производители активных и пассивных электронных компонентов.

Нашей специализацией является поставка электронной компонентной базы двойного назначения, продукции таких производителей как XILINX, Intel (ex.ALTERA), Vicor, Microchip, Texas Instruments, Analog Devices, Mini-Circuits, Amphenol, Glenair.

Сотрудничество с глобальными дистрибьюторами электронных компонентов, предоставляет возможность заказывать и получать с международных складов практически любой перечень компонентов в оптимальные для Вас сроки.

На всех этапах разработки и производства наши партнеры могут получить квалифицированную поддержку опытных инженеров.

Система менеджмента качества компании отвечает требованиям в соответствии с ГОСТ Р ИСО 9001, ГОСТ РВ 0015-002 и ЭС РД 009

Офис по работе с юридическими лицами:

105318, г.Москва, ул.Щербаковская д.3, офис 1107, 1118, ДЦ «Щербаковский»

Телефон: +7 495 668-12-70 (многоканальный)

Факс: +7 495 668-12-70 (доб.304)

E-mail: info@moschip.ru

Skype отдела продаж:

moschip.ru

moschip.ru_4

moschip.ru_6

moschip.ru_9