



Is Now Part of



ON Semiconductor®

To learn more about ON Semiconductor, please visit our website at
www.onsemi.com

Please note: As part of the Fairchild Semiconductor integration, some of the Fairchild orderable part numbers will need to change in order to meet ON Semiconductor's system requirements. Since the ON Semiconductor product management systems do not have the ability to manage part nomenclature that utilizes an underscore (_), the underscore (_) in the Fairchild part numbers will be changed to a dash (-). This document may contain device numbers with an underscore (_). Please check the ON Semiconductor website to verify the updated device numbers. The most current and up-to-date ordering information can be found at www.onsemi.com. Please email any questions regarding the system integration to Fairchild_questions@onsemi.com.

ON Semiconductor and the ON Semiconductor logo are trademarks of Semiconductor Components Industries, LLC dba ON Semiconductor or its subsidiaries in the United States and/or other countries. ON Semiconductor owns the rights to a number of patents, trademarks, copyrights, trade secrets, and other intellectual property. A listing of ON Semiconductor's product/patent coverage may be accessed at www.onsemi.com/site/pdf/Patent-Marking.pdf. ON Semiconductor reserves the right to make changes without further notice to any products herein. ON Semiconductor makes no warranty, representation or guarantee regarding the suitability of its products for any particular purpose, nor does ON Semiconductor assume any liability arising out of the application or use of any product or circuit, and specifically disclaims any and all liability, including without limitation special, consequential or incidental damages. Buyer is responsible for its products and applications using ON Semiconductor products, including compliance with all laws, regulations and safety requirements or standards, regardless of any support or applications information provided by ON Semiconductor. "Typical" parameters which may be provided in ON Semiconductor data sheets and/or specifications can and do vary in different applications and actual performance may vary over time. All operating parameters, including "Typicals" must be validated for each customer application by customer's technical experts. ON Semiconductor does not convey any license under its patent rights nor the rights of others. ON Semiconductor products are not designed, intended, or authorized for use as a critical component in life support systems or any FDA Class 3 medical devices or medical devices with a same or similar classification in a foreign jurisdiction or any devices intended for implantation in the human body. Should Buyer purchase or use ON Semiconductor products for any such unintended or unauthorized application, Buyer shall indemnify and hold ON Semiconductor and its officers, employees, subsidiaries, affiliates, and distributors harmless against all claims, costs, damages, and expenses, and reasonable attorney fees arising out of, directly or indirectly, any claim of personal injury or death associated with such unintended or unauthorized use, even if such claim alleges that ON Semiconductor was negligent regarding the design or manufacture of the part. ON Semiconductor is an Equal Opportunity/Affirmative Action Employer. This literature is subject to all applicable copyright laws and is not for resale in any manner.



FAN4800AU / FAN4800CU PFC/ PWM Controller Combination

Features

- Pin-to-Pin Compatible with ML4800, FAN4800, CM6800, and CM6800A
- PWM Configurable for Current-Mode or Feed-Forward Voltage-Mode Operation
- Internally Synchronized Leading-Edge PFC and Trailing-Edge PWM in One IC
- Low Operating Current
- Innovative Switching-Charge Multiplier Divider
- Average-Current-Mode for Input-Current Shaping
- PFC Over-Voltage and Under-Voltage Protections
- PFC Feedback Open-Loop Protection
- Cycle-by-Cycle Current Limiting for PFC/PWM
- Power-on Sequence Control and Soft-Start
- Line Sagging Protection
- $f_{RTCT}=4 \cdot f_{PFC}=4 \cdot f_{PWM}$ for FAN4800AU
- $f_{RTCT}=4 \cdot f_{PFC}=2 \cdot f_{PWM}$ for FAN4800CU

Applications

- Desktop PC Power Supply
- Internet Server Power Supply
- LCD TV/ Monitor Power Supply
- UPS
- Battery Charger
- DC Motor Power Supply
- Monitor Power Supply
- Telecom System Power Supply
- Distributed Power

Related Resources

- [AN-8027 — FAN480X PFC+PWM Combination Controller Application](#)

Description

The highly integrated FAN4800AU/CU parts are specially designed for power supplies that consist of boost PFC and PWM. They require very few external components to achieve versatile protections and compensation. They are available in 16-pin DIP and SOP packages.

The PWM can be used in current or Voltage Mode. In Voltage Mode, feed-forward from the PFC output bus can reduce secondary output ripple.

To evaluate FAN4800AU/CU for replacing existing FAN4800A/C, FAN4800AS/CS, old version FAN4800 and ML4800 boards, six things must be completed before the fine-tuning procedure:

1. Change R_{AC} resistor from the old value to a higher resistor value: 6 M Ω to 8 M Ω .
2. Change RT/CT pin from the existing values to $R_T=6.8$ k Ω and $C_T=1000$ pF to have $f_{PFC}=64$ kHz and $f_{PWM}=64$ kHz.
3. The VRMS pin needs to be 1.224 V at $V_{IN}=85$ V $_{AC}$ for universal input application with line input from 85 V $_{AC}$ to 270 V $_{AC}$.
4. Change ISENSE pin filter from the exiting values to $R_{Filter}=51$ Ω and $C_{Filter}=0.01$ μ F for higher bandwidth.
5. At full load, the average V_{VEA} must be ~ 4.5 V and ripple on V_{VEA} needs to be less than 400 mV.
6. For the SS pin, the soft-start current has been reduced to half the FAN4800 capacitor.

There are two differences from FAN4800AS/CS to FAN4800AU/CU:

- Add Line Sagging Protection
- Fix Inductance Current Instability during AC Cycle Drop Test

Ordering Information

Part Number	Operating Temperature Range	PFC:PWM Frequency Ratio	Package	Packing Method
FAN4800AUN	-40°C to +105°C	1:1	16-Pin Dual Inline Package (DIP)	Tube
FAN4800CUN		1:2		
FAN4800AUM		1:1	16-Pin Small Outline Package (SOP)	
FAN4800CUM		1:2		

Block Diagram



Figure 1. Function Block Diagram

Application Diagrams



Figure 2. Current Mode



Figure 3. Voltage Mode

Marking Information

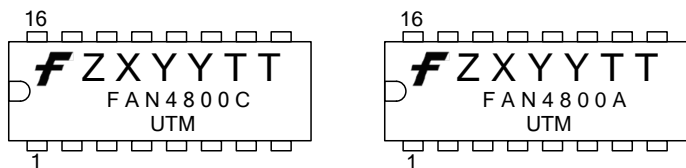

Figure 4. DIP Top Mark

- F – Fairchild Logo
- Z – Plant Code
- X – 1-Digit Year Code
- YY – 2-Digit Week Code
- TT – 2-Digit Die-Run Code
- T – Package Type (N:DIP)
- M – Manufacture Flow Code

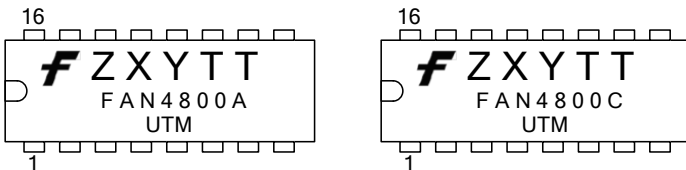

Figure 5. SOP Top Mark

- F – Fairchild Logo
- Z – Plant Code
- X – 1-Digit Year Code
- Y – 1-Digit Week Code
- TT – 2-Digit Die-Run Code
- T – Package Type (M:SOP)
- M – Manufacture Flow Code

Pin Configuration

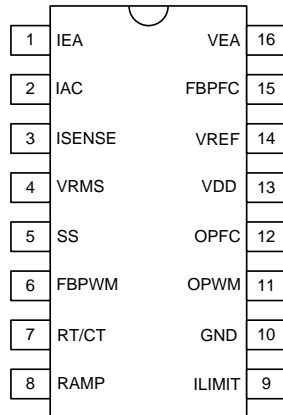

Figure 6. Pin Configuration (Top View)

Pin Definitions

Pin #	Name	Description
1	IEA	Output of PFC Current Amplifier. The signal from this pin is compared with an internal sawtooth to determine the pulse width for the PFC gate drive.
2	IAC	Input AC Current. For normal operation, this input provides a current reference for the multiplier. The suggested maximum I_{AC} is 65 μ A.
3	ISENSE	PFC Current Sense. The inverting input of the PFC current amplifier and the output of multiplier and PFC I_{LIMIT} comparator.
4	VRMS	Line-Voltage Detection. The pin is used for the PFC multiplier.
5	SS	PWM Soft-Start. During startup, the SS pin charges an external capacitor with a 10 μ A constant current source. The voltage on FBPWM is clamped by SS during startup. If a protection condition occurs and/or PWM is disabled, the SS pin is quickly discharged.
6	FBPWM	PWM Feedback Input. The control input for voltage-loop feedback of PWM stage.
7	RT/CT	Oscillator RC Timing Connection. Oscillator timing node; timing set by R_T and C_T .
8	RAMP	PWM RAMP Input. In Current Mode, this pin functions as the current-sense input. In Voltage Mode, it is the feed-forward sense input from PFC output 380 V (feed-forward ramp).
9	ILIMIT	Peak Current Limit Setting for PWM. The peak current limit setting for PWM.
10	GND	Ground
11	OPWM	PWM Gate Drive. The totem-pole output drive for the PWM MOSFET. This pin is internally clamped under 19 V to protect the MOSFET.
12	OPFC	PFC Gate Drive. The totem-pole output drive for PFC MOSFET. This pin is internally clamped under 15 V to protect the MOSFET.
13	VDD	Supply. The power supply pin. The threshold voltages for startup and turn-off are 11 V and 9.3 V, respectively. The operating current is lower than 10 mA.
14	VREF	Reference Voltage. Buffered output for the internal 7.5 V reference.
15	FBPFC	Voltage Feedback Input for PFC. The feedback input for PFC voltage loop. The inverting input of PFC error amplifier. This pin is connected to the PFC output through a divider network.
16	VEA	Output of PFC Voltage Amplifier. The error amplifier output for PFC voltage feedback loop. A compensation network is connected between this pin and ground.

Absolute Maximum Ratings

Stresses exceeding the absolute maximum ratings may damage the device. The device may not function or be operable above the recommended operating conditions and stressing the parts to these levels is not recommended. In addition, extended exposure to stresses above the recommended operating conditions may affect device reliability. The absolute maximum ratings are stress ratings only.

Symbol	Parameter	Min.	Max.	Unit
V _{DD}	DC Supply Voltage		30	V
V _H	Voltage on SS, FBPWM, RAMP, VREF Pins	-0.3	30.0	V
V _{PFC-OUT}	Voltage on OPFC Pin		V _{DD} +0.3V	V
V _{PWM-OUT}	Voltage on OPWM Pin		V _{DD} +0.3V	V
V _L	Voltage on IAC, VRMS, RT/CT, ILIMIT, FBPFC, VEA Pins	-0.3	7.0	V
V _{IEA}	Voltage on IEA Pin	0	V _{VREF} +0.3	V
V _N	Voltage on ISENSE Pin	-5.0	0.7	V
I _{AC}	Input AC Current		1	mA
I _{REF}	VREF Output Current		5	mA
I _{PFC-OUT}	Peak PFC OUT Current, Source or Sink		0.5	A
I _{PWM-OUT}	Peak PWM OUT Current, Source or Sink		0.5	A
P _D	Power Dissipation T _A < 50°C		800	mW
Θ _{JA}	Thermal Resistance (Junction to Air)	DIP	80.80	°C/W
		SOP	104.10	
Θ _{JC}	Thermal Resistance (Junction to Case)	DIP	35.38	°C/W
		SOP	40.41	
T _J	Operating Junction Temperature	-40	+125	°C
T _{STG}	Storage Temperature Range	-55	+150	°C
T _L	Lead Temperature(Soldering)		+260	°C
ESD	Electrostatic Discharge Capability	Human Body Model, JESD22-A114	6.0	kV
		Charged Device Model, JESD22-C101	2.0	

Notes:

- All voltage values, except differential voltage, are given with respect to GND pin.
- Stresses beyond those listed under Absolute Maximum Ratings may cause permanent damage to the device.

Recommended Operating Conditions

The Recommended Operating Conditions table defines the conditions for actual device operation. Recommended operating conditions are specified to ensure optimal performance to the datasheet specifications. Fairchild does not recommend exceeding them or designing to Absolute Maximum Ratings.

Symbol	Parameter	Min.	Max.	Unit
T _A	Operating Ambient Temperature	-40	+105	°C

Electrical Characteristics

Unless otherwise noted, $V_{DD}=15\text{ V}$, $T_A=25^\circ\text{C}$, $T_A=T_J$, $R_T=6.8\text{ k}\Omega$, and $C_T=1000\text{ pF}$.

Symbol	Parameter	Condition	Min.	Typ.	Max.	Unit
V_{DD} Section						
I _{DD-ST}	Startup Current	$V_{DD}=V_{TH-ON}-0.1\text{ V}$, OPFC OPWM Open		30	80	μA
I _{DD-OP}	Operating Current	$V_{DD}=13\text{ V}$, OPFC OPWM Open	2.0	2.6	5.0	mA
V _{TH-ON}	Turn-on Threshold Voltage		10	11	12	V
ΔV_{TH}	Hysteresis		1.3		1.9	V
V _{DD-OVP}	V _{DD} OVP		27	28	29	V
ΔV_{DD-OVP}	V _{DD} OVP Hysteresis			1		V
Oscillator						
f _{OSC-RT/CT}	RT/CT Frequency		240	256	268	kHz
f _{OSC}	PFC & PWM Frequency	$R_T=6.8\text{ k}\Omega$, $C_T=1000\text{ pF}$	60	64	67	kHz
	FAN4800CU PWM Frequency		120	128	134	
f _{DV}	Voltage Stability ⁽³⁾	$11\text{ V} \leq V_{DD} \leq 22\text{ V}$			2	%
f _{DT}	Temperature Stability ⁽³⁾	$-40^\circ\text{C} \sim +105^\circ\text{C}$			2	%
f _{TV}	Total Variation (PFC & PWM) ⁽³⁾	Line, Temperature	58		70	kHz
f _{RV}	Ramp Voltage	Valley to Peak		2.8		V
I _{OSC-DIS}	Discharge Current	$V_{RAMP}=0\text{ V}$, $V_{RT/CT}=2.5\text{ V}$	6.5		15.0	mA
f _{RANGE}	Frequency Range		50		75	kHz
t _{PFC-DEAD}	PFC Dead Time	$R_T=6.8\text{ k}\Omega$, $C_T=1000\text{ pF}$	400	600	800	ns
V_{REF}						
V _{VREF}	Reference Voltage	$I_{VREF}=0\text{ mA}$, $C_{VREF}=0.1\text{ }\mu\text{F}$	7.4	7.5	7.6	V
ΔV_{VREF1}	Load Regulation of Reference Voltage	$C_{VREF}=0.1\text{ }\mu\text{F}$, $I_{VREF}=0\text{ mA}$ to 3.5 mA $V_{DD}=14\text{ V}$, Rise/Fall Time $> 20\text{ }\mu\text{s}$		30	50	mV
ΔV_{VREF2}	Line Regulation of Reference Voltage	$C_{VREF}=0.1\text{ }\mu\text{F}$, $V_{DD}=11\text{ V}$ to 22 V			25	mV
$\Delta V_{VREF-DT}$	Temperature Stability ⁽³⁾	$-40^\circ\text{C} \sim +105^\circ\text{C}$		0.4	0.5	%
$\Delta V_{VREF-TV}$	Total Variation ⁽³⁾	Line, Load, Temperature	7.35		7.65	V
$\Delta V_{VREF-LS}$	Long-Term Stability ⁽³⁾	$T_J=125^\circ\text{C}$, $0 \sim 1000\text{ Hours}$	5		25	mV
I _{VREF-MAX.}	Maximum Current	$V_{VREF} > 7.35\text{ V}$	5			mA
PFC OVP Comparator						
V _{PFC-OVP}	Over-Voltage Protection		2.70	2.75	2.80	V
$\Delta V_{PFC-OVP}$	PFC OVP Hysteresis		200	250	300	mV
Low-Power Detect Comparator						
V _{VEAOFF}	VEA Voltage OFF OPFC		0.2	0.3	0.4	V
V_{IN} OK Comparator						
V _{RD-FBPFC}	Voltage Level on FBPFC to Enable OPWM During Startup		2.3	2.4	2.5	V
$\Delta V_{RD-FBPFC}$	Hysteresis		1.0	1.1	1.2	V

Continued on the following page...

Electrical Characteristics (Continued)Unless otherwise noted, $V_{DD}=15\text{ V}$, $T_A=25^\circ\text{C}$, $T_A=T_J$, $R_T=6.8\text{ k}\Omega$, and $C_T=1000\text{ pF}$.

Symbol	Parameter	Condition	Min.	Typ.	Max.	Unit
Voltage Error Amplifier						
V_{REF}	Reference Voltage		2.45	2.50	2.55	V
A_v	Open-Loop Gain ⁽³⁾		35	42		dB
G_{m_v}	Transconductance	$V_{NONINV}=V_{INV}$, $V_{VEA}=3.75\text{ V}$	50	70	90	μmho
$I_{FBPFC-L}$	Maximum Source Current	$V_{FBPFC}=2\text{ V}$, $V_{VEA}=1.5\text{ V}$	40	50		μA
$I_{FBPFC-H}$	Maximum Sink Current	$V_{FBPFC}=3\text{ V}$, $V_{VEA}=6\text{ V}$		-50	-40	μA
I_{BS}	Input Bias Current		-1		1	μA
V_{VEA-H}	Output High Voltage on V_{VEA}		5.8	6.0		V
V_{VEA-L}	Output Low Voltage on V_{VEA}			0.1	0.4	V
Current Error Amplifier						
G_{m_I}	Transconductance	$V_{NONINV}=V_{INV}$, $V_{IEA}=3.75\text{ V}$	70	88	105	μmho
V_{OFFSET}	Input Offset Voltage	$V_{VEA}=0\text{ V}$, IAC Open	-10		10	mV
V_{IEA-H}	Output High Voltage		6.8	7.4	7.8	V
V_{IEA-L}	Output Low Voltage			0.1	0.4	V
I_L	Source Current	$V_{ISENSE}=-0.6\text{ V}$, $V_{IEA}=1.5\text{ V}$	35	50		μA
I_H	Sink Current	$V_{ISENSE}=+0.6\text{ V}$, $V_{IEA}=4.0\text{ V}$		-50	-35	μA
A_I	Open-Loop Gain ⁽³⁾		40	50		dB
TriFault Detect™						
$t_{FBPFC-OPEN}$	Time to FBPFC Open	$V_{FBPFC}=V_{PFC-UVP}$ to FBPFC OPEN, 470 pF from FBPFC to GND		2	4	ms
$V_{PFC-UVP}$	PFC Feedback Under-Voltage Protection		0.4	0.5	0.6	V
Gain Modulator						
I_{AC}	Input for AC Current ⁽³⁾	Multiplier Linear Range	0		65	μA
GAIN	Gain Modulator ⁽⁴⁾	$I_{AC}=17.67\text{ }\mu\text{A}$, $V_{RMS}=1.080\text{ V}$ $V_{FBPFC}=2.25\text{ V}$		7.94		
		$I_{AC}=20\text{ }\mu\text{A}$, $V_{RMS}=1.224\text{ V}$ $V_{FBPFC}=2.25\text{ V}$		7.02		
		$I_{AC}=25.69\text{ }\mu\text{A}$, $V_{RMS}=1.585\text{ V}$ $V_{FBPFC}=2.25\text{ V}$		4.18		
		$I_{AC}=51.62\text{ }\mu\text{A}$, $V_{RMS}=3.169\text{ V}$ $V_{FBPFC}=2.25\text{ V}$		1.05		
		$I_{AC}=62.23\text{ }\mu\text{A}$, $V_{RMS}=3.803\text{ V}$ $V_{FBPFC}=2.25\text{ V}$		0.73		
BW	Bandwidth ⁽³⁾	$I_{AC}=40\text{ }\mu\text{A}$			2	kHz
$V_o(gm)$	Output Voltage= $5.7\text{ k}\Omega \times (I_{SENSE}-I_{OFFSET})$	$I_{AC}=50\text{ }\mu\text{A}$, $V_{RMS}=1.224\text{ V}$ $V_{FBPFC}=2.25\text{ V}$	0.76	0.80	0.84	V
PFC I_{LIMIT} Comparator						
$V_{PFC-ILIMIT}$	Peak Current Limit Threshold Voltage, Cycle-by-Cycle Limit		-1.2	-1.3	-1.4	V
ΔV_{PK}	PFC I_{LIMIT} -Gain Modulator Output	$I_{AC}=17.67\text{ }\mu\text{A}$, $V_{RMS}=1.08\text{ V}$ $V_{FBPFC}=2.25\text{ V}$	400			mV

Continued on the following page...

Electrical Characteristics (Continued)Unless otherwise noted, $V_{DD}=15\text{ V}$, $T_A=25^\circ\text{C}$, $T_A=T_J$, $R_T=6.8\text{ k}\Omega$, and $C_T=1000\text{ pF}$.

Symbol	Parameter	Condition	Min.	Typ.	Max.	Unit
PFC Output Driver						
$V_{GATE-CLAMP}$	Gate Output Clamping Voltage	$V_{DD}=22\text{ V}$	13	15	17	V
V_{GATE-L}	Gate Low Voltage	$V_{DD}=15\text{ V}$, $I_O=100\text{ mA}$			1.5	V
V_{GATE-H}	Gate High Voltage	$V_{DD}=13\text{ V}$, $I_O=100\text{ mA}$	8			V
t_R	Gate Rising Time	$V_{DD}=15\text{ V}$, $C_L=4.7\text{ nF}$, O/P= 2 V to 9 V	40	70	120	ns
t_F	Gate Falling Time	$V_{DD}=15\text{ V}$, $C_L=4.7\text{ nF}$, O/P=9 V to 2 V	40	60	110	ns
$D_{PFC-MAX}$	Maximum Duty Cycle	$V_{IEA}<1.2\text{ V}$	94	97		%
$D_{PFC-MIN}$	Minimum Duty Cycle	$V_{IEA}>4.5\text{ V}$			0	%
PWM I_{LIMIT} Comparator						
$V_{PWM-ILIMIT}$	Threshold Voltage		0.95	1.00	1.05	V
t_{PD}	Propagation Delay to Output			250		ns
$t_{PWM-BNK}$	Leading-Edge Blanking Time		170	250	350	ns
PWM Output Driver						
$V_{GATE-CLAMP}$	Gate Output Clamping Voltage	$V_{DD}=22\text{ V}$	18	19	20	V
V_{GATE-L}	Gate Low Voltage	$V_{DD}=15\text{ V}$, $I_O=100\text{ mA}$			1.5	V
V_{GATE-H}	Gate High Voltage	$V_{DD}=13\text{ V}$, $I_O=100\text{ mA}$	8			V
t_R	Gate Rising Time	$V_{DD}=15\text{ V}$, $C_L=4.7\text{ nF}$, O/P=2 V to 9 V	30	60	120	ns
t_F	Gate Falling Time	$V_{DD}=15\text{ V}$, $C_L=4.7\text{ nF}$, O/P=9 V to 2 V	30	50	110	ns
$D_{PWM-MAX}$	Maximum Duty Cycle		49.0	49.5	50.0	%
V_{PWM-LS}	PWM Comparator Level Shift		1.3	1.5	1.8	V
Soft-Start						
V_{SS-MAX}	Maximum Voltage	$V_{DD}=15\text{ V}$	9.5	10.0	10.5	V
I_{SS}	Soft-Start Current			10		μA
Brownout						
$V_{RMS-UVL}$	VRMS Threshold LOW		1.00	1.05	1.10	V
$V_{RMS-UVH}$	VRMS Threshold HIGH		1.85	1.90	1.95	V
$\Delta V_{RMS-UVP}$	Hysteresis		750	850	950	mV
t_{UVP}	Under- Voltage Protection Delay		750	1000	1250	ms
Sagging Protection						
$V_{RMS-SAG}$	VRMS Threshold SAG LOW		0.80	0.85	0.90	V
t_{SAG}	SAG Protection Delay		28	33	38	ms

Notes:

- This parameter, although guaranteed by design, is not 100% production tested.
- This gain is the maximum gain of modulation with a given V_{RMS} voltage when V_{VEA} is saturated to HIGH.

Typical Characteristics

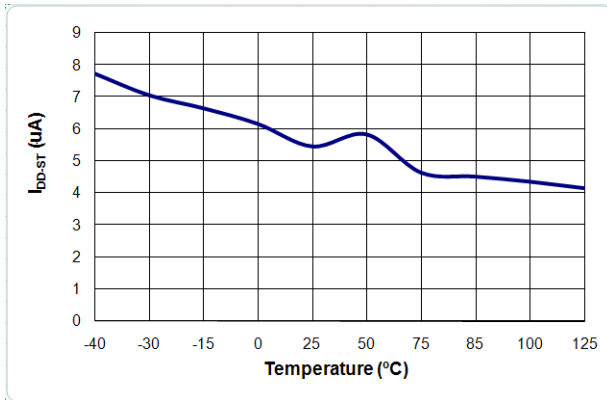

Figure 7. I_{DD-ST} vs. Temperature

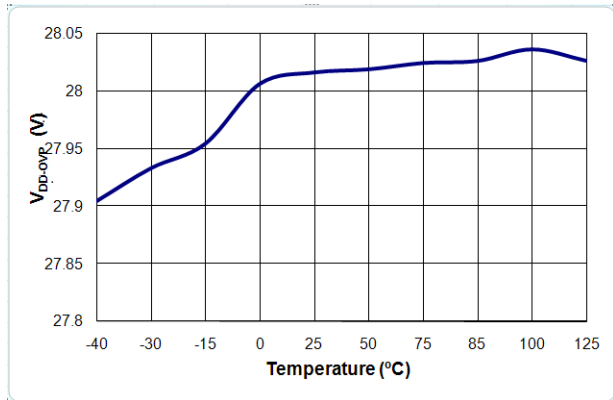

Figure 8. V_{DD-OVP} vs. Temperature

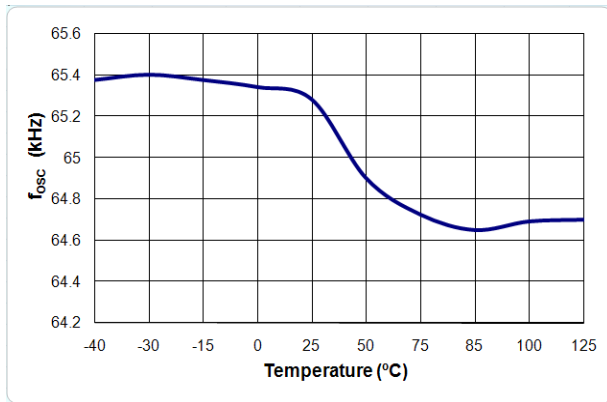

Figure 9. f_{osc} vs. Temperature



Figure 10. V_{VREF} vs. Temperature

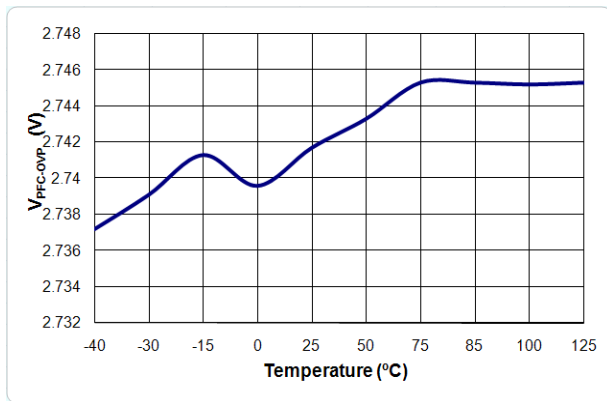

Figure 11. V_{PFC-OVP} vs. Temperature



Figure 12. V_{REF} vs. Temperature

Typical Characteristics

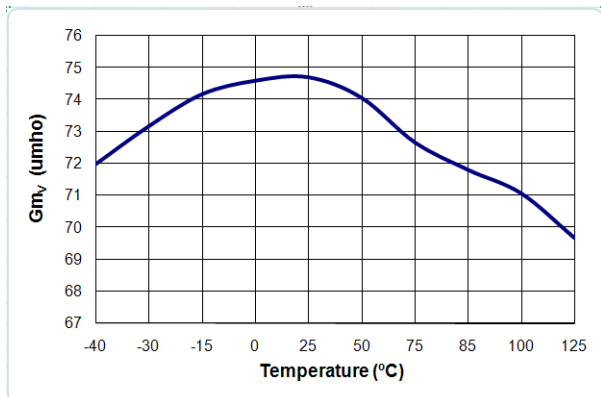

Figure 13. G_{mV} vs. Temperature

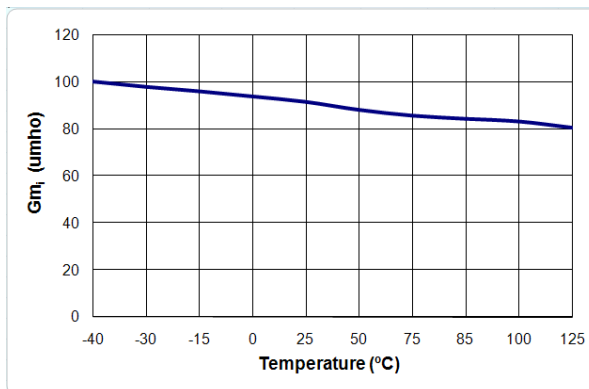

Figure 14. G_{mI} vs. Temperature

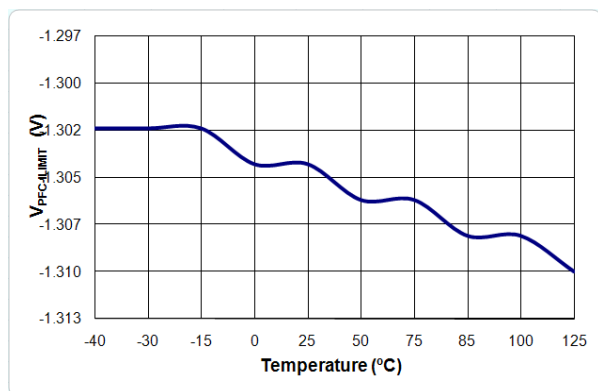

Figure 15. $V_{PFC-ILIMIT}$ vs. Temperature

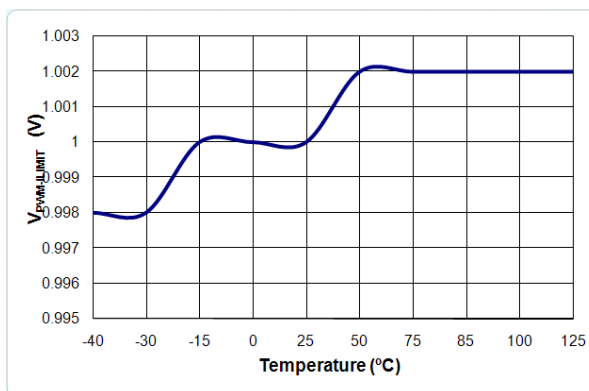

Figure 16. $V_{PWM-ILIMIT}$ vs. Temperature

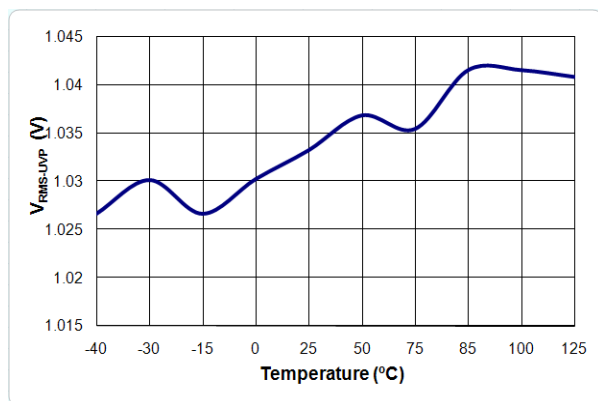

Figure 17. $V_{RMS-UIVP}$ vs. Temperature

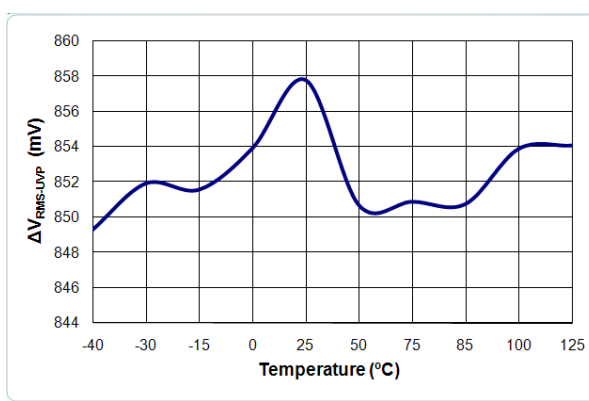

Figure 18. $\Delta V_{RMS-UIVP}$ vs. Temperature

Typical Characteristics

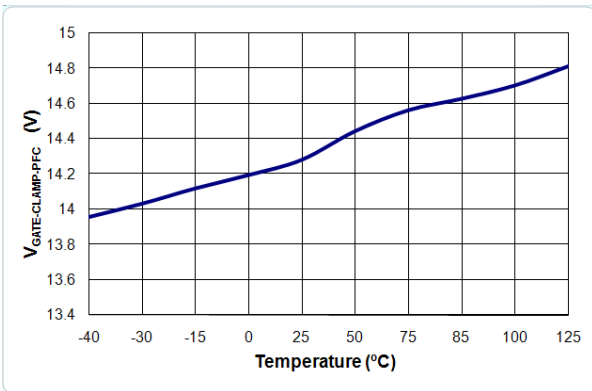

Figure 19. V_{GATE-CLAMP-PFC} vs. Temperature

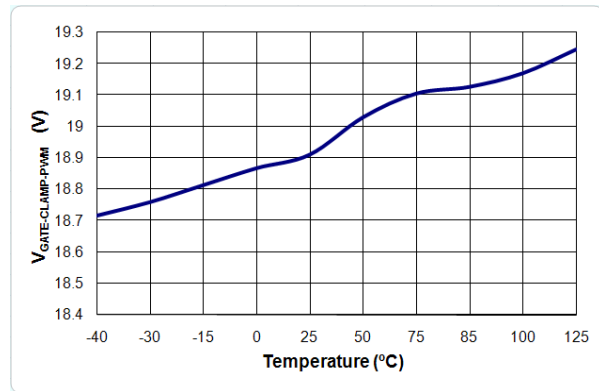

Figure 20. V_{GATE-CLAMP-PWM} vs. Temperature

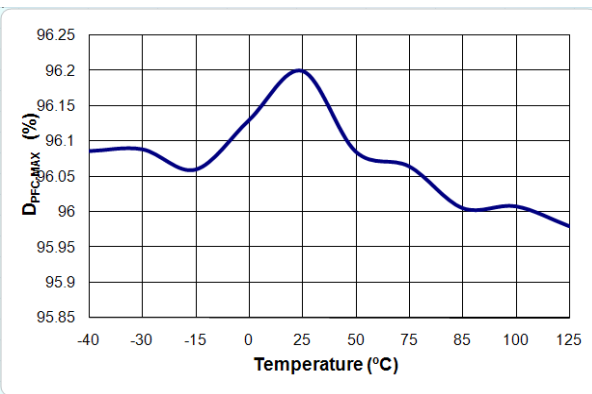

Figure 21. D_{PFC-MAX} vs. Temperature

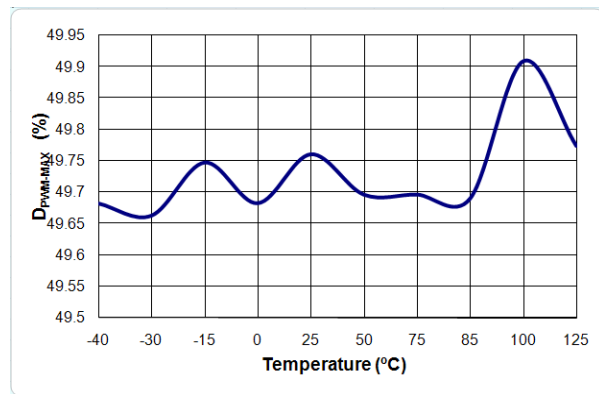

Figure 22. D_{PWM-MAX} vs. Temperature



Figure 23. I_{SS} vs. Temperature

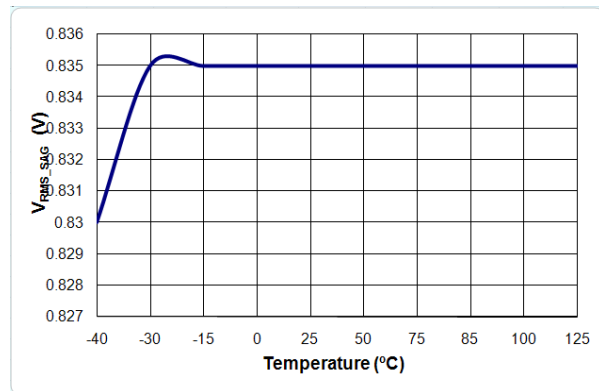

Figure 24. V_{RMS-SAG} vs. Temperature

Functional Description

Oscillator

The internal oscillator frequency is determined by the timing resistor and capacitor on the RT/CT pins as shown in Figure 25. The frequency of the internal oscillator is given by:

$$f_{osc} = \frac{1}{0.56 \cdot R_T \cdot C_T + 360C_T} \quad (1)$$

Because the PWM stage generally uses a forward converter, it is necessary to limit the maximum duty cycle at 50%. To have a small tolerance of the maximum duty cycle, a frequency divider with toggle flip-flops is used, as illustrated in Figure 25. The operation frequency of PFC and PWM stage is 1/4 of oscillator frequency. (For FAN4800CU, the operation frequencies for PFC and PWM stages are 1/4 and 1/2 of oscillator frequency, respectively).

The dead time for the PFC gate drive signal is determined by:

$$t_{DEAD} = 360C_T \quad (2)$$

The dead time should be smaller than 2% of the switching period to minimize line current distortion around the line zero crossing.

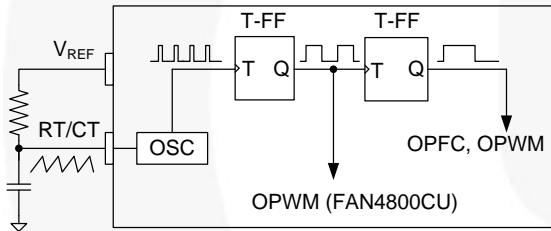

Figure 25. Oscillator Configuration



Figure 26. Timing Diagram



Figure 27. Interleaved Leading / Trailing Edge Modulation

Figure 27 shows the interleaved leading / trailing edge modulation, where the turn-off of the PFC drive signal is synchronized to the turn-on of the PWM drive signal. This technique allows the PFC output diode current to flow directly into the downstream DC/DC converter, minimizing the current ripple of PFC output capacitor.

Gain Modulator

Gain modulator is the key block for the PFC stage because it provides the reference to the current control error amplifier for the input current shaping, as shown in Figure 28. The output current of the gain modulator is a function of V_{EA} , I_{AC} , and V_{RMS} . The gain of the gain modulator is given as a ratio between I_{MO} and I_{AC} with a given V_{RMS} when V_{EA} is saturated to HIGH. The gain is inversely proportional to V_{RMS}^2 , as shown in Figure 29, to implement line feed-forward. This automatically adjusts the reference of current control error amplifier according to the line voltage, such that the input power of PFC converter is not changed with line voltage (as shown in Figure 30).

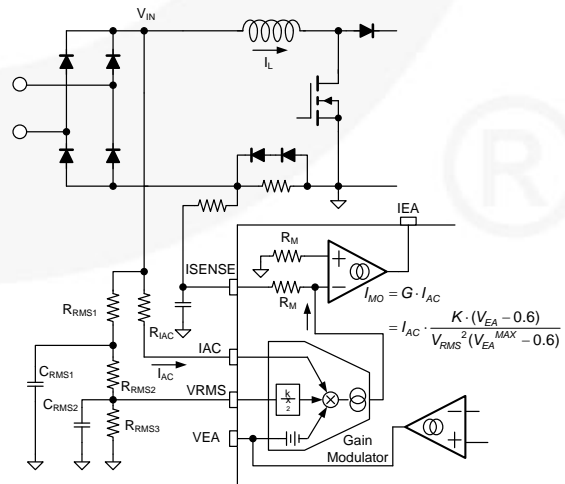

Figure 28. Gain Modulator Block

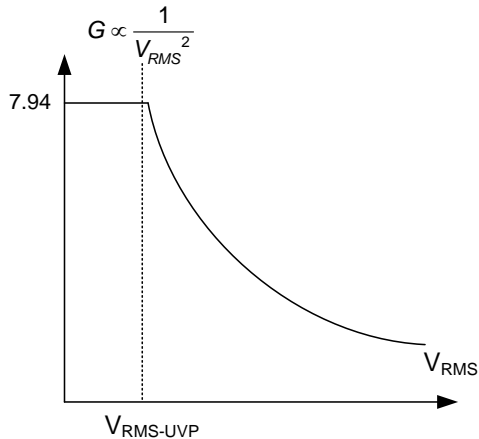

Figure 29. Modulation Gain Characteristics

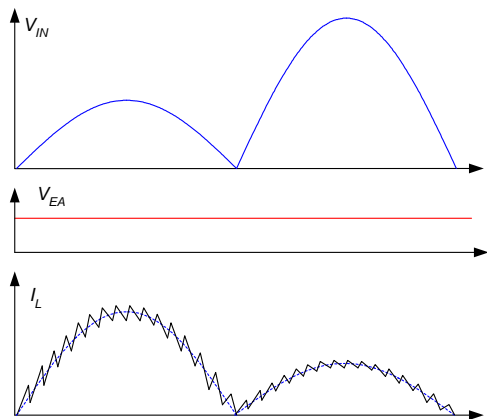

Figure 30. Line Feed-Forward Operation

To sense the RMS value of the line voltage, averaging circuit with two poles is typically employed, as shown in Figure 28. Notice that the input voltage of the PFC is clamped at the peak of the line voltage once the PFC stops switching because the junction capacitance of the bridge diode is not discharged, as shown in Figure 31. Therefore, the voltage divider for V_{RMS} should be designed considering the brownout protection trip-point and minimum operation line voltage.

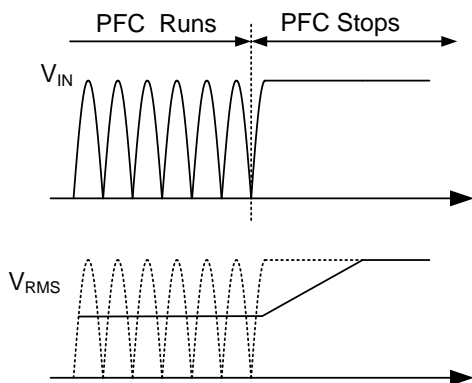

Figure 31. V_{RMS} According to the PFC Operation

The rectified sinusoidal signal is obtained by the current flowing into the IAC pin. The resistor R_{IAC} should be large enough to prevent saturation of the gain modulator, calculating as:

$$\frac{\sqrt{2}V_{LINE}^{MIN}}{R_{IAC}} \cdot G^{MAX} < 140\mu A \quad (3)$$

where V_{LINE}^{MIN} is the line voltage that trips brownout protection, G^{MAX} is the maximum modulator gain when V_{RMS} is 1.08 V (which can be found in the datasheet), and 140 μA is the maximum output current of the gain modulator.

Current Control of Boost Stage

The FAN4800AU/CU employs two control loops for power factor correction, as shown in Figure 32: a current-control loop and a voltage-control loop. The current-control loop shapes inductor current as shown in Figure 33 based on the reference signal obtained at the IAC pin calculated as:

$$I_L \cdot R_{CS1} = I_{MO} \cdot R_M = I_{AC} \cdot G \cdot R_M \quad (4)$$

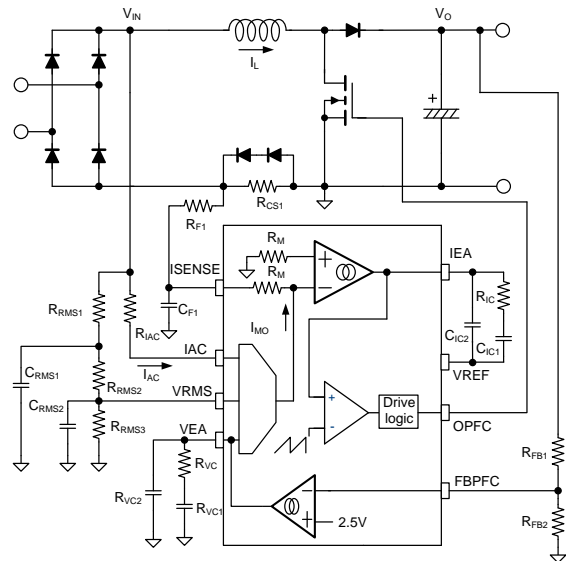

Figure 32. Gain Modulation Block

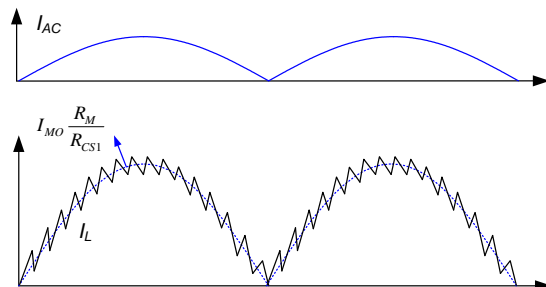

Figure 33. Inductor Current Shaping

The current-control feedback loop also has a pulse-by-pulse current limit comparator that forces the PFC switch to turn off until the next switching cycle if the ISENSE pin voltage drops below -1.3 V.

Voltage Control of Boost Stage

The voltage-control loop regulates PFC output voltage using an internal error amplifier such that the FB voltage is the same as the internal reference of 2.5 V.

Brownout Protection

The built-in internal brownout protection comparator monitors the voltage of the VRMS pin. Once VRMS pin voltage is lower than 1.05 V, the PFC stage is shut down to protect the system from over current. FAN4800AU/CU starts up the boost stage once VRMS voltage increases above 1.9 V.

TriFault Detect™

To improve power supply reliability, reduce system component count, and simplify compliance to UL 1950 safety standards, the FAN4800AU/CU includes Fairchild's TriFault Detect technology.

In a feedback path failure, the output voltage of the PFC can exceed safe operating limits. TriFault Detect protects the power supply from a failure related to the output feedback by monitoring the FBPFC voltage.

TriFault Detect is an entirely internal circuit. It requires no external components to serve its protective function.



Figure 34. TriFault Detect™

PWM Stage

The PWM stage is capable of Current Mode or Voltage Mode operation. In Current-Mode, the PWM ramp (RAMP) is usually derived directly from a current-sensing resistor or current transformer in the primary side of the output stage, and is thereby representative of the current flowing in the converter's output stage. I_{LIMIT}, which provides cycle-by-cycle current limiting, is typically connected to RAMP in such applications.

For Voltage-Mode operation, RAMP can be connected to a separate RC timing network to generate a voltage ramp against which the FBPWM voltage is compared. Under these conditions, the voltage feed-forward from the PFC bus can be used for better line transient response.

No voltage error amplifier is included in the PWM stage, as this function is generally performed by KA431, in the secondary side. To facilitate the design of opto-coupler feedback circuitry, an offset voltage is built into the inverting input of PWM comparator. This allows FBPWM to command a zero percent duty cycle when its pin voltage is below 1.5 V.



Figure 35. PWM Ramp Generation Circuit

PWM Current Limit

The I_{LIMIT} pin is a direct input to the cycle-by-cycle current limiter for the PWM section. If the input voltage at this pin exceeds 1 V, the output of the PWM is disabled for until the start of the next PWM clock cycle.

V_{IN} OK Comparator

The V_{IN}OK comparator monitors the output of the PFC stage and inhibits the PWM stage if this voltage is less than 2.4 V (96% of its nominal value). Once this voltage goes above 2.4 V, the PWM stage begins soft-start. The PWM stage is shut down when FBPFC voltage drops below 1.3 V.

PWM Soft-Start (SS)

PWM startup is controlled by the soft-start capacitor. A current source of 10 μA supplies the charging current for the soft-start capacitor. PWM startup is prohibited until the soft-start capacitor voltage reaches 1.5 V.

AC Line Drops Out

FAN4800AU/CU is designed such that the operation of PFC part is not perturbed by AC line dropout. Once line voltage disappears, the error amplifier can be saturated, resulting in abnormal current waveforms when the line voltage is recovered if proper preventive measures are not employed.

With a limited gain modulator operation, FAN4800AU/CU guarantees stable PFC operation even when AC line is recovered from dropout, as shown in Figure 36.

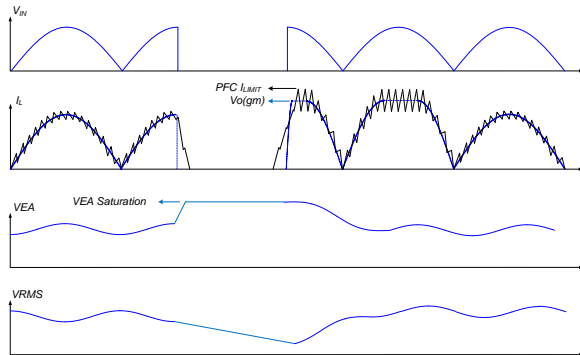

Figure 36. AC Cycle Drop

Line Sag Protection

When the line sags below its normal operational range, the PFC part keeps operating until the brownout protection is triggered, which has 1 s debounce time. Due to the low line voltage, the gain modulator for current loop is saturated and input current of PFC is limited, resulting in a drop of the PFC output voltage at heavy-load condition. Since the PWM part has a V_{IN} OK comparator that shuts down PWM operation when the FBPF voltage drops below 1.3 V, the downstream DC-DC converter can stop operation while the PFC output voltage drops during line sag. Once the downstream converter stops operation, even the limited PFC input current can charge up the PFC output since the PFC part has no load current. Because this can cause repeated startup and shutdown of downstream converter during line sag, FAN4800AU/CU has line sag protection.

There are two conditions that trigger line sag protection, as shown in Figure 37 and Figure 38. The first condition is when V_{RMS} is lower than $V_{RMS-SAG}$ (0.85 V) for longer than t_{SAG} (33 ms), as shown in Figure 37. The second condition is when V_{RMS} is lower than $V_{RMS-SAG}$ (0.85 V) and V_{FBPFC} is lower than V_{IN-OFF} (1.3 V), as shown in Figure 38. Once line sag protection is triggered, the PWM and the PFC stop operation until V_{RMS} increases above 1.9 V.

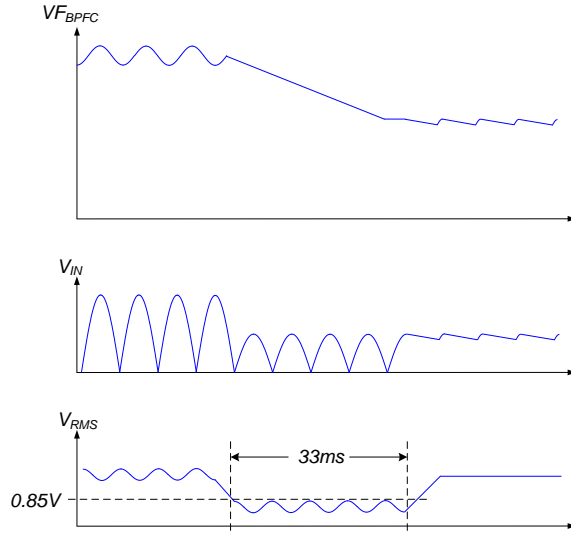

Figure 37. The First Condition of Sag Protection

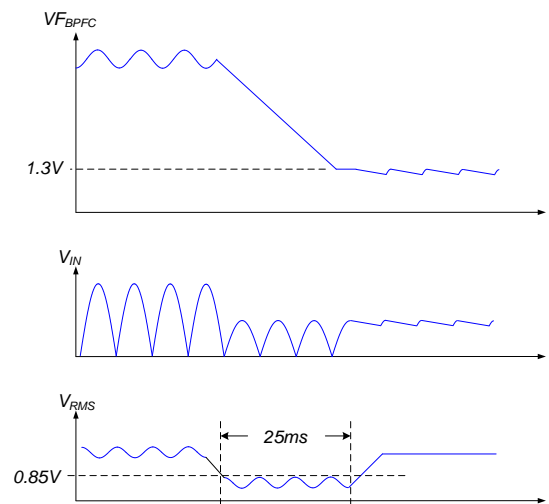

Figure 38. The Second condition of Sag Protection



NOTES:

- A. CONFORMS TO JEDEC MS-001, VARIATION BB
- B. ALL DIMENSIONS ARE IN MILLIMETERS
- C. DIMENSIONS ARE EXCLUSIVE OF BURRS, MOLD FLASH, AND TIE BAR PROTRUSIONS
- D. DIMENSIONS AND TOLERANCES PER ASME Y14.5M-2009
- E. DRAWING FILENAME: MKT-N16Erev3





TOP VIEW



LAND PATTERN RECOMMENDATION



FRONT VIEW

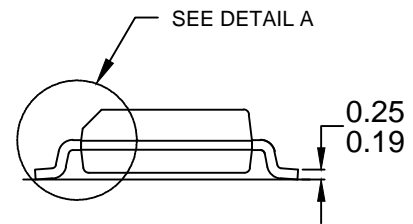

DETAIL A

SCALE: 2:1

NOTES:

- A) THIS PACKAGE CONFORMS TO JEDEC MS-012, VARIATION AC, ISSUE C.
- B) ALL DIMENSIONS ARE IN MILLIMETERS.
- C) DIMENSIONS ARE EXCLUSIVE OF BURRS, MOLD FLASH AND TIE BAR PROTRUSIONS
- D) CONFORMS TO ASME Y14.5M-2009
- E) LANDPATTERN STANDARD:
SOIC127P600X175-16AM
- F) DRAWING FILE NAME: M16AREV13.



ON Semiconductor and  are trademarks of Semiconductor Components Industries, LLC dba ON Semiconductor or its subsidiaries in the United States and/or other countries. ON Semiconductor owns the rights to a number of patents, trademarks, copyrights, trade secrets, and other intellectual property. A listing of ON Semiconductor's product/patent coverage may be accessed at www.onsemi.com/site/pdf/Patent-Marking.pdf. ON Semiconductor reserves the right to make changes without further notice to any products herein. ON Semiconductor makes no warranty, representation or guarantee regarding the suitability of its products for any particular purpose, nor does ON Semiconductor assume any liability arising out of the application or use of any product or circuit, and specifically disclaims any and all liability, including without limitation special, consequential or incidental damages. Buyer is responsible for its products and applications using ON Semiconductor products, including compliance with all laws, regulations and safety requirements or standards, regardless of any support or applications information provided by ON Semiconductor. "Typical" parameters which may be provided in ON Semiconductor data sheets and/or specifications can and do vary in different applications and actual performance may vary over time. All operating parameters, including "Typicals" must be validated for each customer application by customer's technical experts. ON Semiconductor does not convey any license under its patent rights nor the rights of others. ON Semiconductor products are not designed, intended, or authorized for use as a critical component in life support systems or any FDA Class 3 medical devices or medical devices with a same or similar classification in a foreign jurisdiction or any devices intended for implantation in the human body. Should Buyer purchase or use ON Semiconductor products for any such unintended or unauthorized application, Buyer shall indemnify and hold ON Semiconductor and its officers, employees, subsidiaries, affiliates, and distributors harmless against all claims, costs, damages, and expenses, and reasonable attorney fees arising out of, directly or indirectly, any claim of personal injury or death associated with such unintended or unauthorized use, even if such claim alleges that ON Semiconductor was negligent regarding the design or manufacture of the part. ON Semiconductor is an Equal Opportunity/Affirmative Action Employer. This literature is subject to all applicable copyright laws and is not for resale in any manner.

PUBLICATION ORDERING INFORMATION

LITERATURE FULFILLMENT:

Literature Distribution Center for ON Semiconductor
19521 E. 32nd Pkwy, Aurora, Colorado 80011 USA
Phone: 303-675-2175 or 800-344-3860 Toll Free USA/Canada
Fax: 303-675-2176 or 800-344-3867 Toll Free USA/Canada
Email: orderlit@onsemi.com

N. American Technical Support: 800-282-9855 Toll Free
USA/Canada
Europe, Middle East and Africa Technical Support:
Phone: 421 33 790 2910
Japan Customer Focus Center
Phone: 81-3-5817-1050

ON Semiconductor Website: www.onsemi.com
Order Literature: <http://www.onsemi.com/orderlit>
For additional information, please contact your local
Sales Representative

Mouser Electronics

Authorized Distributor

Click to View Pricing, Inventory, Delivery & Lifecycle Information:

[ON Semiconductor:](#)

[FAN4800CUM](#) [FAN4800CUN](#)

Данный компонент на территории Российской Федерации

Вы можете приобрести в компании MosChip.

Для оперативного оформления запроса Вам необходимо перейти по данной ссылке:

<http://moschip.ru/get-element>

Вы можете разместить у нас заказ для любого Вашего проекта, будь то серийное производство или разработка единичного прибора.

В нашем ассортименте представлены ведущие мировые производители активных и пассивных электронных компонентов.

Нашей специализацией является поставка электронной компонентной базы двойного назначения, продукции таких производителей как XILINX, Intel (ex.ALTERA), Vicor, Microchip, Texas Instruments, Analog Devices, Mini-Circuits, Amphenol, Glenair.

Сотрудничество с глобальными дистрибьюторами электронных компонентов, предоставляет возможность заказывать и получать с международных складов практически любой перечень компонентов в оптимальные для Вас сроки.

На всех этапах разработки и производства наши партнеры могут получить квалифицированную поддержку опытных инженеров.

Система менеджмента качества компании отвечает требованиям в соответствии с ГОСТ Р ИСО 9001, ГОСТ РВ 0015-002 и ЭС РД 009

Офис по работе с юридическими лицами:

105318, г.Москва, ул.Щербаковская д.3, офис 1107, 1118, ДЦ «Щербаковский»

Телефон: +7 495 668-12-70 (многоканальный)

Факс: +7 495 668-12-70 (доб.304)

E-mail: info@moschip.ru

Skype отдела продаж:

moschip.ru

moschip.ru_4

moschip.ru_6

moschip.ru_9