

PLEASE CHECK WWW.MOLEX.COM FOR LATEST PART INFORMATION

Part Number: [0473001022](#)
Status: **Active**
Overview: slimline serial ata odd connectors
Description: 1.00mm(.039"), 1.27mm (.050") Pitch Slimline Serial ATA Plug for Optical Disk Drive with DIP Standard Type Soldering Tabs, Right Angle, 0.76µm (30µ") Gold (Au) Plating, with Peg, 5.4mm (.213") Mounted Height, Lead-free

Documents:

[3D Model](#) [Product Specification PS-47300-001 \(PDF\)](#)
[Drawing \(PDF\)](#) [RoHS Certificate of Compliance \(PDF\)](#)

Agency Certification

CSA LR 19980

General

Product Family PCB Headers
 Series [47300](#)
 Application Board-to-Board
 Comments Soldering Standard Type
 Overview [slimline serial ata odd connectors](#)
 Product Name Serial ATA, Slimline Serial ATA

Physical

Breakaway No
 Circuits (Loaded) 13
 Circuits (maximum) 13
 Durability (mating cycles max) 500
 First Mate / Last Break Yes
 Flammability 94V-0
 Glow-Wire Compliant No
 Guide to Mating Part Yes
 Keying to Mating Part Yes
 Lock to Mating Part No
 Material - Plating Mating Gold
 Material - Plating Termination Tin
 Material - Resin High Temperature Thermoplastic
 Number of Rows 1
 Orientation Right Angle
 PCB Locator Yes
 PCB Retention Yes
 Packaging Type Embossed Tape on Reel
 Pitch - Mating Interface (in) 0.039 In, 0.050 In
 Pitch - Mating Interface (mm) 1.00 mm, 1.27 mm
 Pitch - Term. Interface (in) 0.039 In, 0.050 In
 Pitch - Term. Interface (mm) 1.00 mm, 1.27 mm
 Plating min: Mating (µin) 30
 Plating min: Mating (µm) 0.76
 Plating min: Termination (µin) 39
 Plating min: Termination (µm) 1
 Polarized to Mating Part Yes
 Polarized to PCB Yes
 Stackable No
 Temperature Range - Operating -35°C to +85°C
 Termination Interface: Style Surface Mount

Electrical

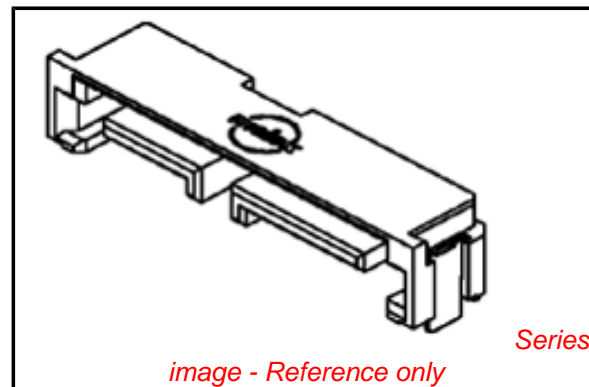

EU RoHS

ELV and RoHS Compliant
REACH SVHC Contains SVHC: No
Halogen-Free Status

China RoHS



Need more information on product environmental compliance?

Email productcompliance@molex.com
 For a multiple part number RoHS Certificate of Compliance, [click here](#)

Please visit the [Contact Us](#) section for any non-product compliance questions.

Search Parts in this Series

[47300Series](#)

Mates With

[47628](#) , [47639](#), [47645](#), [47650](#), [78380](#),
[48321](#), [48325](#), [48330](#), [48336](#), [47657](#)
 Slimline Serial ATA Receptacles

Current - Maximum per Contact	1.5A
Voltage - Maximum	15V DC

Solder Process Data

Duration at Max. Process Temperature (seconds)	10
Lead-free Process Capability	Reflow Capable (SMT only)
Max. Cycles at Max. Process Temperature	1
Process Temperature max. C	260

Material Info

Reference - Drawing Numbers

Packaging Specification	PK-47300-001, PK-47300-003
Product Specification	PS-47300-001
Sales Drawing	SD-47300-100

This document was generated on 05/26/2010

PLEASE CHECK WWW.MOLEX.COM FOR LATEST PART INFORMATION

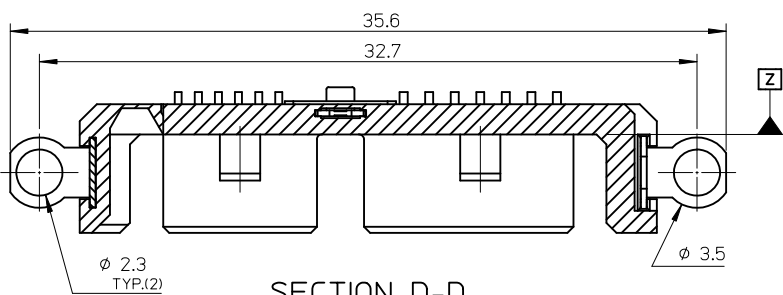

SECTION D-D

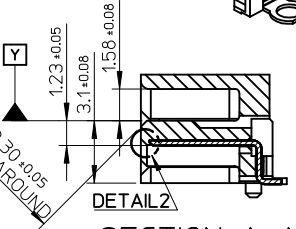
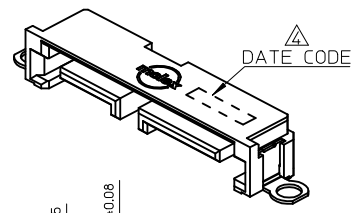

SECTION A-A

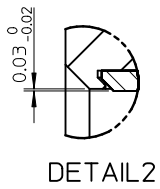
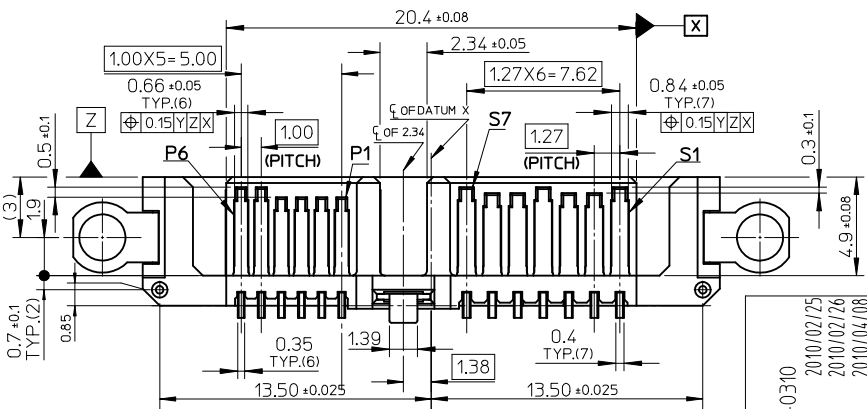
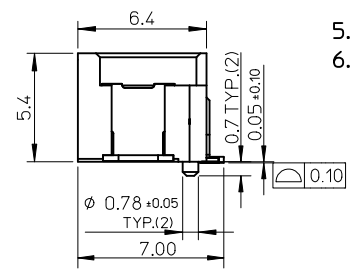
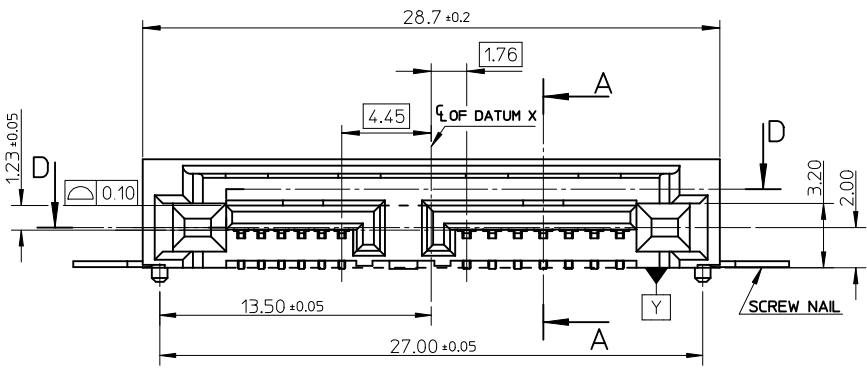

DETAIL2

NOTES :

- 1.MATERIAL :
HOUSING : HIGH TEMPERATURE THERMOPLASTIC,
30% G.F., UL94V-0, BLACK
TERMINAL : COPPER ALLOY, THICKNESS=0.25 MM
SCREW NAIL : STAINLESS, THICKNESS=0.30 MM
SOLDERING NAIL : COPPER ALLOY, THICKNESS=0.30 MM
- 2.PLATING :
TERMINAL :
CONTACT AREA : GOLD PLATING 0.1 MICRONS MIN.
SOLDERING AREA : MATTE TIN PLATING 1.0 MICRONS MIN.
UNDERPLATING : NICKEL PLATING 2.5 MICRONS MIN.
SOLDERING NAIL : MATTE TIN PLATING 1.0 MICRONS MIN.
OVER NICKEL PLATING 1.0 MICRONS MIN.
- 3.PRODUCT SPECIFICATION: PS-47300-001.
- DATE CODE FORMAT: YY/MM/DD/XX/S, 'XX' IS USED TO MARK
TERMINAL GOLD PLATING SPEC,
'05' IS FOR FL5H; '15' IS FOR 15u"; '30' IS FOR 30u".
'S' IS A SPECIAL LETTER FOR FACTORY TO TRACK.
- 5.PRODUCT PACKAGE SPEC: PK-47300-001.
- 6.THE PRODUCT COMPLIANT TO RoSH DIRECTIVE 2002/95/EC
AND ELV DIRECTIVE 2000/53/EC.

P/N	CONTACT PLATING	NAIL
47300-1000	GOLD FLASH	
47300-1002	GOLD 0.38 MICRONS MIN	STAINLESS STEEL, NO PLATING
47300-1004	GOLD 0.76 MICRONS MIN	
47300-1001	GOLD FLASH	
47300-1003	GOLD 0.38 MICRONS MIN	PHOSPHOR BRONZE, MATTE TIN PLATING
47300-1005	GOLD 0.76 MICRONS MIN	

REVISED	EC NO: SH2010-0310	DRWING: GLLI	CHKD: CH'KD:	APPR: RZHANG	DESCRIPTION	QUALITY SYMBOLS		GENERAL TOLERANCES (UNLESS SPECIFIED)		DIMENSION STYLE		SCALE		DESIGN UNITS		THIRD ANGLE PROJECTION	
						mm	INCH	MM ONLY	4:1	METRIC	THIRD ANGLE PROJECTION						
0	0	0	0	0	0	4 PLACES	± ---	± ---	DRAWN BY	DATE	TITLE						
0	0	0	0	0	0	3 PLACES	± ---	± ---	GLLI	2010/02/25	SLIMLINE SATA PLUG FOR OPTIC DISK DRIVER						
0	0	0	0	0	0	2 PLACES	± ---	± ---	CHECKED BY	DATE	SCREW STANDARD TYPE						
0	0	0	0	0	0	1 PLACE	± ---	± ---	APPROVED BY	DATE	MOLEX INCORPORATED						
ANGULAR ± 3 °						DRAFT WHERE APPLICABLE MUST REMAIN WITHIN DIMENSIONS		SEE TABLE		DOCUMENT NO.		SD-47300-100		SHEET NO.			
REVISED						SIZE		THIS DRAWING CONTAINS INFORMATION THAT IS PROPRIETARY TO MOLEX INCORPORATED AND SHOULD NOT BE USED WITHOUT WRITTEN PERMISSION									

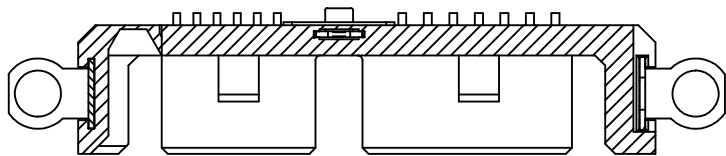

SECTION D1-D1

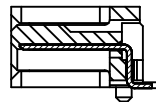

SECTION A1-A1

NOTES : OTHER DIMENSIONS AND NOTES REFER TO SHEET-1.

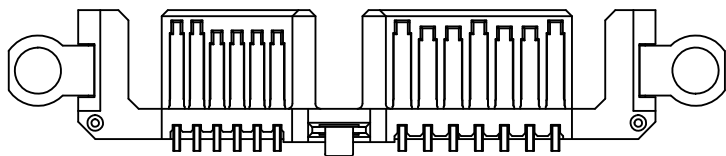
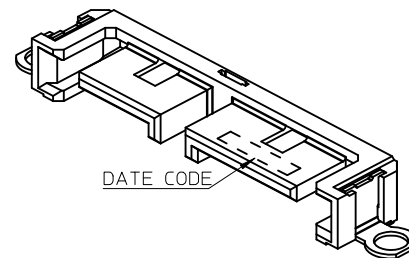
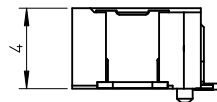
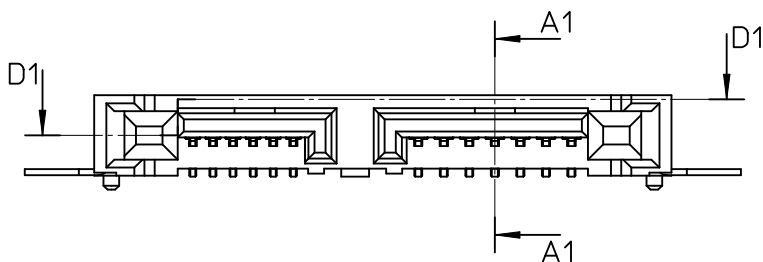

P/N	CONTACT PLATING	NAIL
47300-1014	GOLD FLASH	
47300-1012	GOLD 0.38 MICRONS MIN	STAINLESS STEEL, NO PLATING
47300-1010	GOLD 0.76 MICRONS MIN	
47300-1015	GOLD FLASH	
47300-1013	GOLD 0.38 MICRONS MIN	PHOSPHOR BRONZE, MATTE TIN PLATING
47300-1011	GOLD 0.76 MICRONS MIN	

REVISED EC NO: SH2010-0310 DRWNG: GLL1 CHKD: APPR: RZHANG REV	DESCRIPTION 2010/02/25 2010/02/26 2010/04/08	QUALITY SYMBOLS	GENERAL TOLERANCES (UNLESS SPECIFIED)	DIMENSION STYLE	SCALE	DESIGN UNITS	THIRD ANGLE PROJECTION	
		$\nabla_F=0$ $\nabla_E=0$ $\nabla_D=0$	mm INCH 4 PLACES ± --- ± --- 3 PLACES ± --- ± --- 2 PLACES ± --- ± --- 1 PLACE ± --- ± --- ANGULAR ± 3 °	MM ONLY	4:1	METRIC	DRAWN BY: GLL1 DATE: 2010/02/25 CHECKED BY: DATE: APPROVED BY: RZHANG DATE: 2010/02/26	TITLE SLIMLINE SATA PLUG FOR OPTIC DISK DRIVER SCREW LOW TYPE MOLEX INCORPORATED DOCUMENT NO. SD-47300-100 SHEET NO. 2 OF 7
		DRAFT WHERE APPLICABLE MUST REMAIN WITHIN DIMENSIONS		SEE TABLE	THIS DRAWING CONTAINS INFORMATION THAT IS PROPRIETARY TO MOLEX INCORPORATED AND SHOULD NOT BE USED WITHOUT WRITTEN PERMISSION			
				SIZE A3				

10 9 8 7 6 5 4 3 2 1

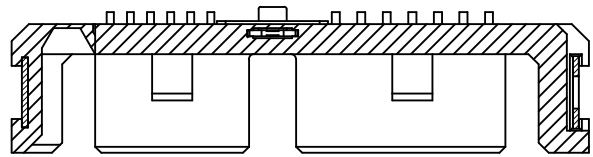

SECTION D-D

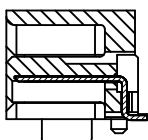

SECTION A-A

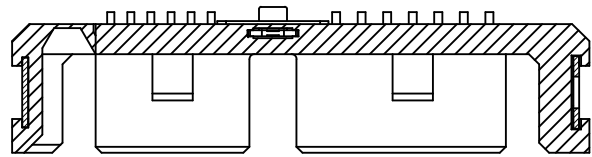

SECTION Z-Z

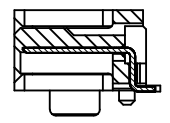

SECTION Y-Y

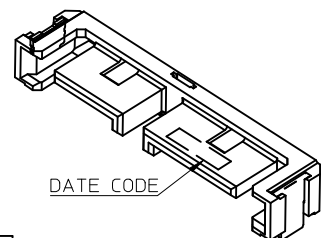
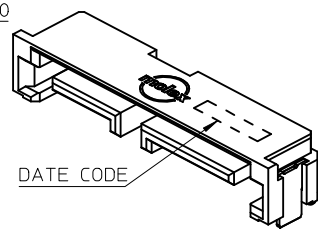
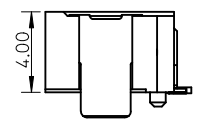
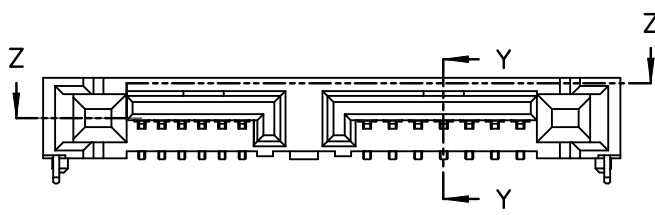
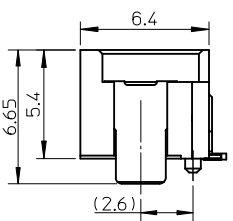
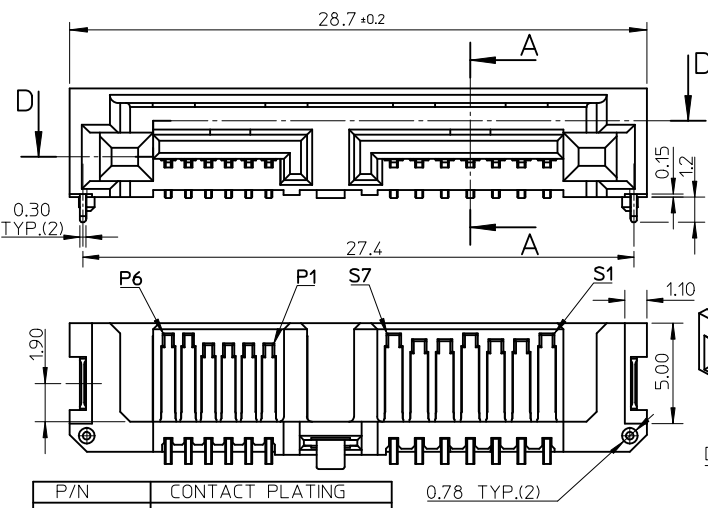

P/N	CONTACT PLATING
47300-1022	GOLD 0.76 MICRONS MIN
47300-1021	GOLD 0.38 MICRONS MIN
47300-1023	GOLD FLASH

P/N	CONTACT PLATING
47300-1032	GOLD 0.76 MICRONS MIN
47300-1031	GOLD 0.38 MICRONS MIN
47300-1030	GOLD FLASH

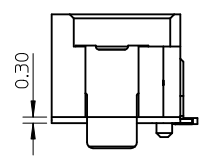
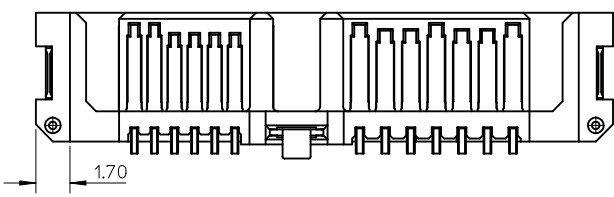

NOTES: ONLY FOR 47300-1020, OTHER DIMENSION AND NOTES REFER TO 47300-1023.

NOTES : OTHER DIMENSIONS AND NOTES REFER TO 47300-102X.

- NOTES :
- MATERIAL :
SOLDERING PEG : COPPER ALLOY
 - PLATING :
SOLDERING PEG :
MATTE TIN PLATING 1.0 MICRONS MIN.
OVER NICKEL PLATING 1.0 MICRONS MIN.
 - PRODUCT PACKAGE SPEC: PK-47300-003.
 - OTHER NOTES AND DIMENSIONS REFER TO SHEET-1.

REVISED	DESCRIPTION	QUALITY SYMBOLS
J	REV	▽F=0
J	REV	▽F=0
J	REV	▽F=0

GENERAL TOLERANCES (UNLESS SPECIFIED)	
	mm INCH
4 PLACES	± --- ± ---
3 PLACES	± --- ± ---
2 PLACES	± --- ± ---
1 PLACE	± --- ± ---
ANGULAR ± 3 °	
DRAFT WHERE APPLICABLE MUST REMAIN WITHIN DIMENSIONS	

DIMENSION STYLE	
MM ONLY	
DRAWN BY	DATE
GLL I	2010/02/25
CHECKED BY	DATE
APPROVED BY	DATE
RZHANG	2010/02/26
MATERIAL NO.	
SEE TABLE OR NOTES	
SIZE	
A3	

SCALE	DESIGN UNITS	THIRD ANGLE PROJECTION
4:1	METRIC	☉
TITLE		
SLIMLINE SATA PLUG FOR OPTIC DISK DRIVER		
SOLDERING STANDARD TYPE		
MOLEX INCORPORATED		
DOCUMENT NO.	SHEET NO.	
SD-47300-100	4 OF 7	
THIS DRAWING CONTAINS INFORMATION THAT IS PROPRIETARY TO MOLEX INCORPORATED AND SHOULD NOT BE USED WITHOUT WRITTEN PERMISSION		

9 8 7 6 5 4 3 2 1

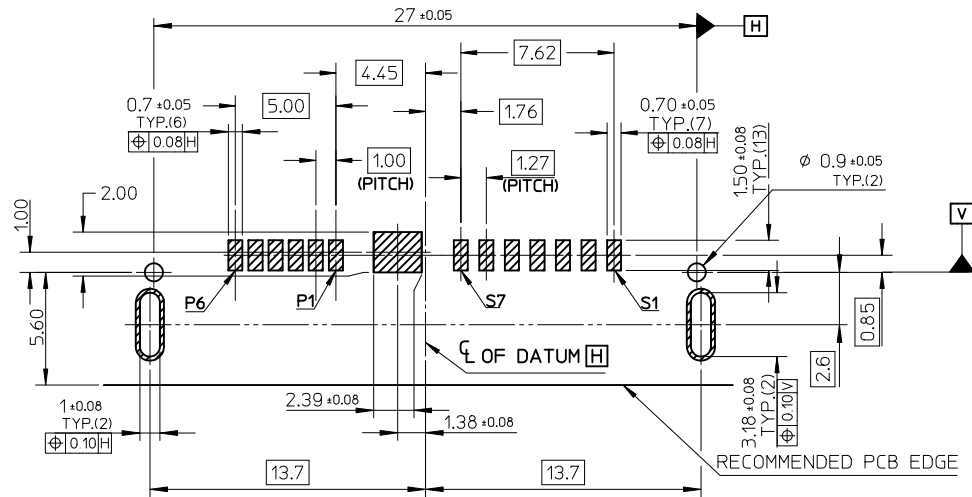

RECOMMEND PCB LAYOUT (THICKNESS=0.8)

REMARK:
THE PCB LAYOUT IS ONLY FOR 47300-102X AND 47300-103X.

REVISED EC NO: SH2010-0310 DRWNG: GLL I CHKD: 2010/02/26 APPR: RZHANG 2010/04/08	QUALITY SYMBOLS F=0 F=0 F=0	GENERAL TOLERANCES (UNLESS SPECIFIED)		DIMENSION STYLE MM ONLY	SCALE 4:1	DESIGN UNITS METRIC	THIRD ANGLE PROJECTION		
		4 PLACES ± --- ± ---	mm INCH	DRAWN BY GLL I	DATE 2010/02/25	TITLE SLIMLINE SATA PLUG FOR OPTIC DISK DRIVER SOLDERING TYPE			
		3 PLACES ± --- ± ---		CHECKED BY DATE		MOLEX INCORPORATED			
		2 PLACES ± --- ± ---		APPROVED BY RZHANG		DATE 2010/02/26	DOCUMENT NO. SD-47300-100		
		1 PLACE ± --- ± ---		MATERIAL NO. SEE REMARK		SHEET NO. 5 OF 7			
		ANGULAR ± 3 °		THIS DRAWING CONTAINS INFORMATION THAT IS PROPRIETARY TO MOLEX INCORPORATED AND SHOULD NOT BE USED WITHOUT WRITTEN PERMISSION					
DRAFT WHERE APPLICABLE MUST REMAIN WITHIN DIMENSIONS									

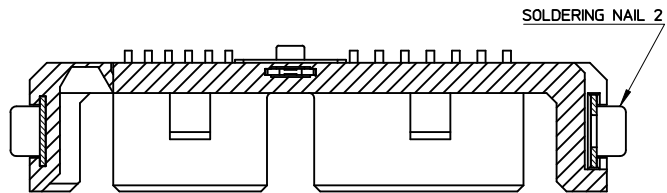

SECTION D-D

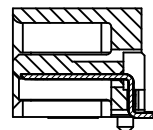

SECTION A-A

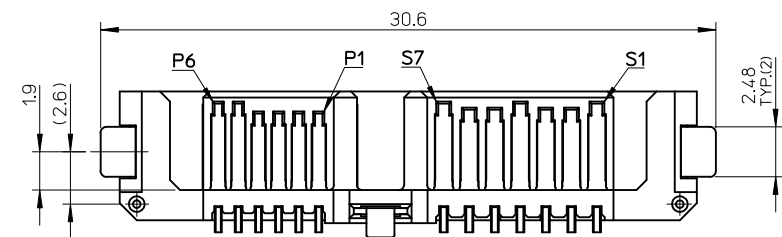
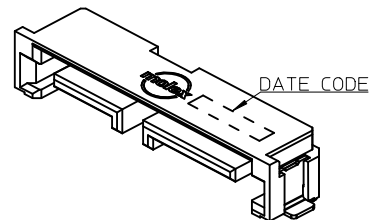
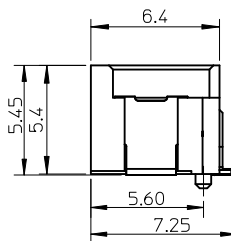
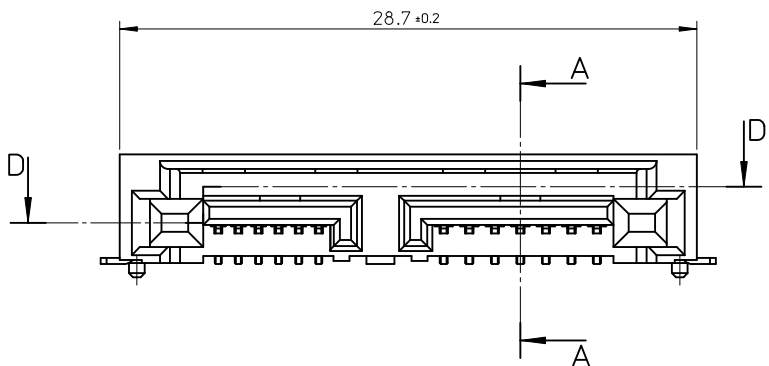

P/N	CONTACT PLATING
47300-1042	GOLD 0.76 MICRONS MIN
47300-1041	GOLD 0.38 MICRONS MIN
47300-1040	GOLD FLASH

NOTES :

- MATERIAL :
SOLDERING NAIL 2 : COPPER ALLOY
- PLATING :
SOLDERING NAIL 2 : MATTE TIN PLATING 1.0 MICRONS MIN.
OVER NICKEL PLATING 1.0 MICRONS MIN.
- OTHER NOTES AND DIMENSIONS REFER TO SHEET-1.

REVISED EC NO: SH2010-0310 DRWN:GLL 2010/02/25 CHKD: 2010/07/26 APPR:RZHANG 2010/04/08	DESCRIPTION QUALITY SYMBOLS $\nabla_A = 0$ $\nabla_G = 0$ $\nabla_P = 0$	GENERAL TOLERANCES (UNLESS SPECIFIED)		DIMENSION STYLE MM ONLY	SCALE 4:1	DESIGN UNITS METRIC	THIRD ANGLE PROJECTION		
		4 PLACES ± --- ± --- 3 PLACES ± --- ± --- 2 PLACES ± --- ± --- 1 PLACE ± --- ± ---	mm INCH	DRAWN BY GLL I	DATE 2010/02/25	TITLE SLIMLINE SATA PLUG FOR OPTIC DISK DRIVER FITTING STANDARD TYPE			
		ANGULAR ± 3 °		APPROVED BY RZHANG	DATE 2010/02/26	MOLEX INCORPORATED			
		DRAFT WHERE APPLICABLE MUST REMAIN WITHIN DIMENSIONS		MATERIAL NO. SEE TABLE	DOCUMENT NO. SD-47300-100	SHEET NO. 6 OF 7			

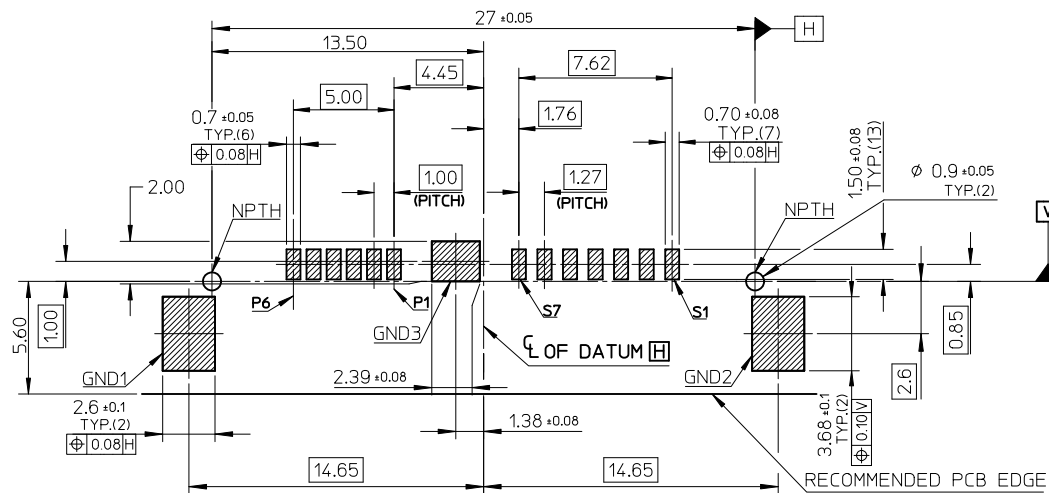

RECOMMEND PCB LAYOUT

REMARK:
THE PCB LAYOUT IS ONLY FOR 47300-104X

REVISED IEC NO: SH2010-0310 DRWNG:GLL1 CHYKD: APPR:RZHANG	2010/02/25 2010/02/26 2010/04/08	QUALITY SYMBOLS $\nabla_F = 0$ $\nabla_F = 0$ $\nabla_F = 0$	GENERAL TOLERANCES (UNLESS SPECIFIED)		DIMENSION STYLE MM ONLY	SCALE 4:1	DESIGN UNITS METRIC	THIRD ANGLE PROJECTION		
			4 PLACES ± --- ± --- 3 PLACES ± --- ± --- 2 PLACES ± --- ± --- 1 PLACE ± --- ± ---	DRAWN BY: GLL1 DATE: 2010/02/25	TITLE SLIMLINE SATA PLUG FOR OPTIC DISK DRIVER FITTING TYPE					
			ANGULAR ± 3 °	CHECKED BY: DATE:	APPROVED BY: RZHANG DATE: 2010/02/26	MOLEX INCORPORATED				
			DRAFT WHERE APPLICABLE MUST REMAIN WITHIN DIMENSIONS	MATERIAL NO. SEE REMARK	DOCUMENT NO. SD-47300-100	SHEET NO. 7 OF 7				

Данный компонент на территории Российской Федерации

Вы можете приобрести в компании MosChip.

Для оперативного оформления запроса Вам необходимо перейти по данной ссылке:

<http://moschip.ru/get-element>

Вы можете разместить у нас заказ для любого Вашего проекта, будь то серийное производство или разработка единичного прибора.

В нашем ассортименте представлены ведущие мировые производители активных и пассивных электронных компонентов.

Нашей специализацией является поставка электронной компонентной базы двойного назначения, продукции таких производителей как XILINX, Intel (ex.ALTERA), Vicor, Microchip, Texas Instruments, Analog Devices, Mini-Circuits, Amphenol, Glenair.

Сотрудничество с глобальными дистрибьюторами электронных компонентов, предоставляет возможность заказывать и получать с международных складов практически любой перечень компонентов в оптимальные для Вас сроки.

На всех этапах разработки и производства наши партнеры могут получить квалифицированную поддержку опытных инженеров.

Система менеджмента качества компании отвечает требованиям в соответствии с ГОСТ Р ИСО 9001, ГОСТ РВ 0015-002 и ЭС РД 009

Офис по работе с юридическими лицами:

105318, г.Москва, ул.Щербаковская д.3, офис 1107, 1118, ДЦ «Щербаковский»

Телефон: +7 495 668-12-70 (многоканальный)

Факс: +7 495 668-12-70 (доб.304)

E-mail: info@moschip.ru

Skype отдела продаж:

moschip.ru

moschip.ru_4

moschip.ru_6

moschip.ru_9