

# BGA7127

400 MHz to 2700 MHz 0.5 W high linearity silicon amplifier

Rev. 3 — 3 December 2010

Product data sheet

## 1. Product profile

### 1.1 General description

The MMIC is a one-stage amplifier, offered in a low-cost leadless surface-mount package. It delivers 28 dBm output power at 1 dB gain compression and a superior performance up to 2700 MHz. Its power saving features include simple quiescent current adjustment, which allows class-AB operation and logic-level shutdown control to reduce the supply current to 4  $\mu$ A.

### 1.2 Features and benefits

- 400 MHz to 2700 MHz frequency operating range
- 12 dB small signal gain at 2 GHz
- 28 dBm output power at 1 dB gain compression
- Integrated active biasing
- External matching allows broad application optimization of the electrical performance
- 5 V single supply operation
- All pins ESD protected

### 1.3 Applications

- Broadband CPE/MoCA
- WLAN/ISM/RFID
- Wireless infrastructure (base station, repeater, backhaul systems)
- Industrial applications
- E-metering
- Satellite Master Antenna TV (SMATV)

### 1.4 Quick reference data

**Table 1. Quick reference data**

Input and output impedances matched to 50  $\Omega$ ,  $\overline{SHDN} = HIGH$  (shutdown disabled). Typical values at  $V_{CC} = 5$  V;  $I_{CC} = 180$  mA;  $T_{case} = 25$  °C; unless otherwise specified.

Symbol	Parameter	Conditions	Min	Typ	Max	Unit
f	frequency		[1] 400	-	2700	MHz
$G_p$	power gain	f = 2140 MHz	10.5	12.0	13.5	dB
$P_{L(1dB)}$	output power at 1 dB gain compression	f = 2140 MHz	26.5	28.0	-	dBm
$IP3_O$	output third-order intercept point	f = 2140 MHz	[2] 39.0	42.0	-	dBm

[1] Operation outside this range is possible but not guaranteed.

[2]  $P_L = 17$  dBm per tone; spacing = 1 MHz.



## 2. Pinning information

### 2.1 Pinning

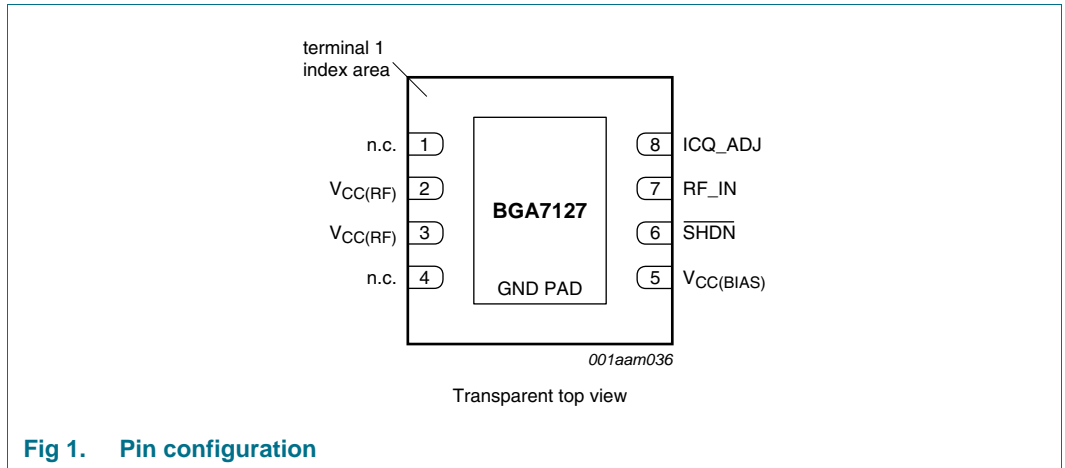


Fig 1. Pin configuration

### 2.2 Pin description

Table 2. Pin description

Symbol	Pin	Description
n.c.	1, 4	not connected
$V_{CC(RF)}$	2, 3	RF output for the power amplifier and DC supply input for the RF transistor collector [1]
$V_{CC(BIAS)}$	5	bias supply voltage [2]
$\overline{SHDN}$	6	shutdown control function enabled / disabled
RF_IN	7	RF input for the power amplifier [1]
ICQ_ADJ	8	quiescent collector current adjustment by an external resistor
GND	GND pad	RF ground and DC ground [3]

[1] This pin is DC-coupled and requires an external DC-blocking capacitor.

[2] RF decoupled.

[3] The center metal base of the SOT908-1 also functions as heatsink for the power amplifier.

## 3. Ordering information

Table 3. Ordering information

Type number	Package		Version
	Name	Description	
BGA7127	HVSON8	plastic thermal enhanced very thin small outline package; no leads; 8 terminals; body 3 × 3 × 0.85 mm	SOT908-1

### 4. Functional diagram

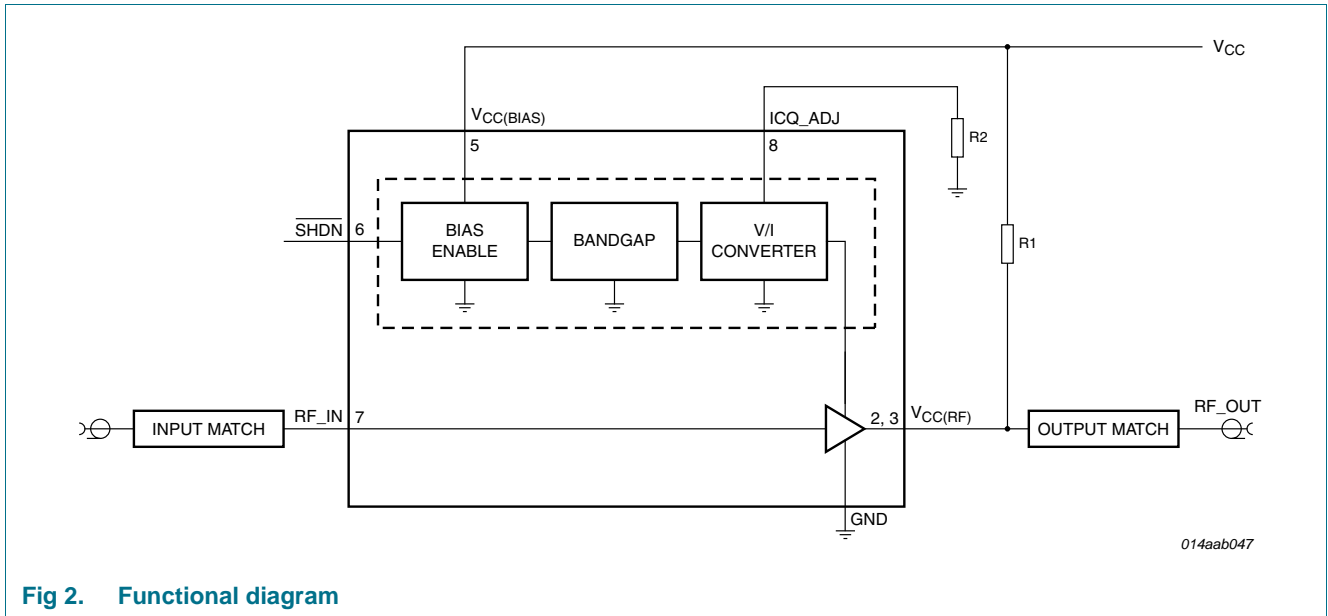


Fig 2. Functional diagram

### 5. Shutdown control

Table 4. Shutdown control settings

Mode	Mode description	Function description	SHDN	V <sub>ctrl(sd)</sub> (V)		I <sub>ctrl(sd)</sub> (μA)	
				Min	Max	Min	Max
Idle	medium power MMIC fully off; minimal supply current	shutdown control enabled	0	0	0.7	-	2
TX	medium power MMIC transmit mode	shutdown control disabled	1	2.5	V <sub>CC(BIAS)</sub>	-	3

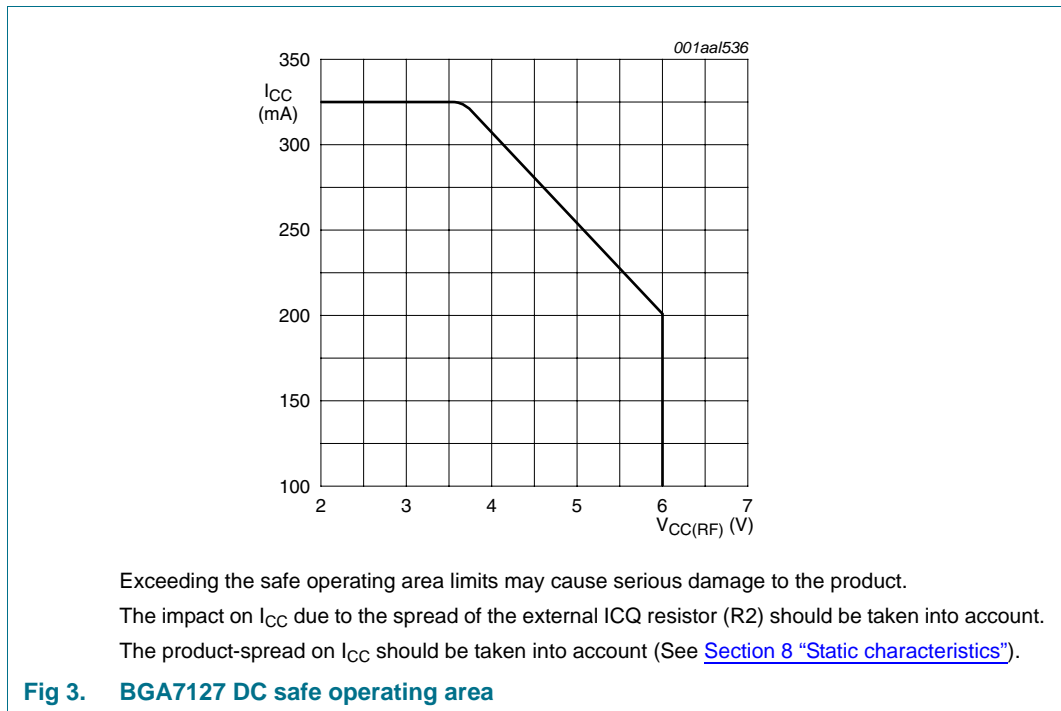
## 6. Limiting values

**Table 5. Limiting values**

In accordance with the Absolute Maximum Rating System (IEC 60134).

Symbol	Parameter	Conditions	Min	Max	Unit
$V_{CC(RF)}$	RF supply voltage		[1] -	6.0	V
$V_{CC(BIAS)}$	bias supply voltage		[1] -	6.0	V
$I_{CC}$	supply current		[1][2] -	325	mA
$V_{ctrl(sd)}$	shutdown control voltage		[3] 0.0	$V_{CC(BIAS)}$	V
$P_{i(RF)}$	RF input power	$f = 2140$ MHz; switched	[4] -	25	dBm
$T_{case}$	case temperature		-40	+85	°C
$T_j$	junction temperature		-	150	°C
$V_{ESD}$	electrostatic discharge voltage	Human Body Model (HBM); According JEDEC standard 22-A114E	-	2000	V
		Charged Device Model (CDM); According JEDEC standard 22-C101B	-	500	V

- [1] See [Figure 3](#) for safe operating area.
- [2] The supply current is adjustable. See [Section 8.1 "Supply current adjustment"](#) and [Section 12 "Application information"](#).
- [3] If  $V_{ctrl(sd)}$  exceeds  $V_{CC(BIAS)}$ , the internal ESD circuit can be damaged. The recommended preventive measure is to limit the  $I_{ctrl(sd)}$  to 20 mA. If the SHDN function is not used, the  $\overline{SHDN}$  pin should be connected to  $V_{CC(BIAS)}$ .
- [4] Withstands switching between zero and maximum  $P_{i(RF)}$ .



## 7. Thermal characteristics

**Table 6. Thermal characteristics**

Symbol	Parameter	Conditions	Typ	Max	Unit
$R_{th(j-mb)}$	thermal resistance from junction to mounting base	$T_{case} = 85\text{ °C}; V_{CC} = 5\text{ V}; I_{CC} = 180\text{ mA}$	[1] 28	-	K/W

[1] Defined as thermal resistance from junction to GND pad.

## 8. Static characteristics

**Table 7. Static characteristics**

Input and output impedances matched to 50 Ω,  $\overline{SHDN} = HIGH$  (shutdown disabled). Typical values at  $V_{CC} = 5.0\text{ V}; T_{case} = 25\text{ °C}$ ; unless otherwise specified.

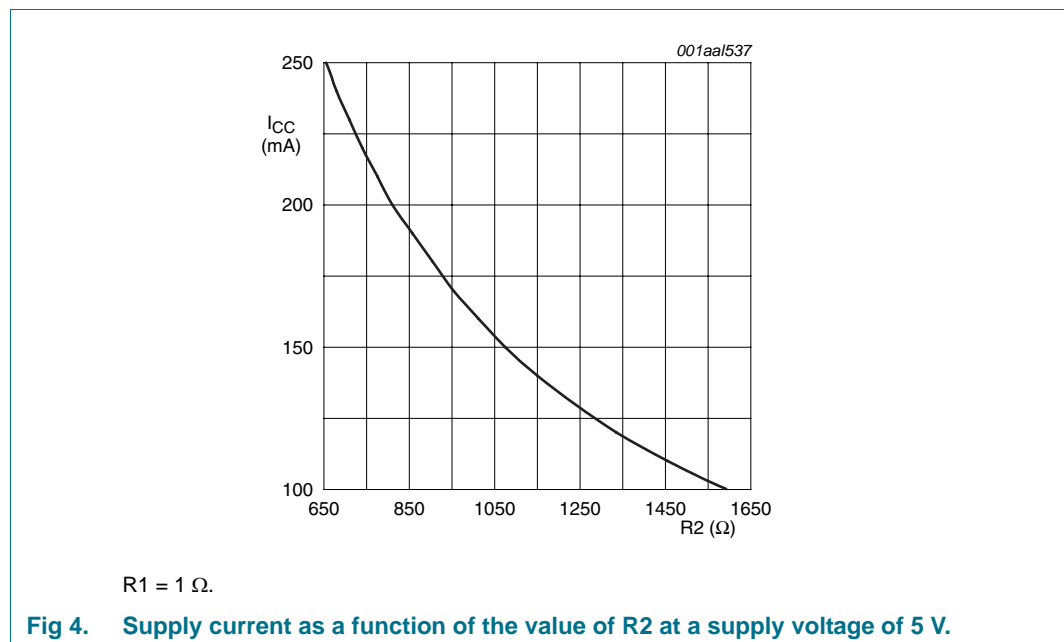
Symbol	Parameter	Conditions	Min	Typ	Max	Unit
$I_{CC}$	supply current		[1] 100	-	250	mA
		$R1 = 1\text{ }\Omega; R2 = 909\text{ }\Omega, E96$	[2] 160	180	200	mA
		$R1 = 1.8\text{ }\Omega; R2 = 909\text{ }\Omega, E96$	[2] 160	180	200	mA
		during shutdown; pin $\overline{SHDN} = LOW$ (shutdown enabled)	-	4	6	μA

[1] The supply current is adjustable. See [Section 8.1 "Supply current adjustment"](#) and [Section 12 "Application information"](#).

[2] See [Section 12 "Application information"](#).

### 8.1 Supply current adjustment

The supply current can be adjusted by changing the value of external ICQ resistor (R2).



## 9. Dynamic characteristics

**Table 8. Dynamic characteristics**

Input and output impedances matched to 50  $\Omega$ ,  $\overline{\text{SHDN}} = \text{HIGH}$  (shutdown disabled). Typical values at  $V_{CC} = 5 \text{ V}$ ;  $I_{CC} = 180 \text{ mA}$ ;  $T_{\text{case}} = 25 \text{ }^\circ\text{C}$ ; see [Section 12 "Application information"](#); unless otherwise specified.

Symbol	Parameter	Conditions	Min	Typ	Max	Unit
f	frequency		[1] 400	-	2700	MHz
G <sub>p</sub>	power gain	f = 940 MHz	[2] -	20.0	-	dB
		f = 1960 MHz	[2] -	13.0	-	dB
		f = 2140 MHz	[2] 10.5	12.0	13.5	dB
		f = 2445 MHz	[2] -	10.5	-	dB
P <sub>L(1dB)</sub>	output power at 1 dB gain compression	f = 940 MHz	-	27.5	-	dBm
		f = 1960 MHz	-	28.5	-	dBm
		f = 2140 MHz	26.5	28.0	-	dBm
		f = 2445 MHz	-	27.5	-	dBm
IP <sub>3O</sub>	output third-order intercept point	f = 940 MHz	[3] -	41.5	-	dBm
		f = 1960 MHz	[3] -	42.5	-	dBm
		f = 2140 MHz	[3] 39.0	42.0	-	dBm
		f = 2445 MHz	[3] -	41.5	-	dBm
NF	noise figure	f = 940 MHz	-	3.1	-	dB
		f = 1960 MHz	-	4.5	-	dB
		f = 2140 MHz	-	4.6	-	dB
		f = 2445 MHz	-	4.7	-	dB
RL <sub>in</sub>	input return loss	f = 940 MHz	[2] -	-25	-	dB
		f = 1960 MHz	[2] -	-9	-	dB
		f = 2140 MHz	[2] -	-9	-	dB
		f = 2445 MHz	[2] -	-11	-	dB
RL <sub>out</sub>	output return loss	f = 940 MHz	[2] -	-12	-	dB
		f = 1960 MHz	[2] -	-14	-	dB
		f = 2140 MHz	[2] -	-10	-	dB
		f = 2445 MHz	[2] -	-17	-	dB

[1] Operation outside this range is possible but not guaranteed.

[2] Defined at P<sub>i</sub> = -40 dBm; small signal conditions.

[3] P<sub>L</sub> = 17 dBm; tone spacing = 1 MHz.

## 9.1 Scattering parameters

**Table 9. Scattering parameters, MMIC only**

$V_{CC} = 5\text{ V}$ ;  $I_{CC} = 180\text{ mA}$ ;  $T_{case} = 25\text{ }^{\circ}\text{C}$ .

f (MHz)	S <sub>11</sub>		S <sub>21</sub>		S <sub>12</sub>		S <sub>22</sub>	
	Magnitude (ratio)	Angle (degree)	Magnitude (ratio)	Angle (degree)	Magnitude (ratio)	Angle (degree)	Magnitude (ratio)	Angle (degree)
400	0.92	178	8.64	91	0.01	45	0.75	-173
500	0.91	176	6.95	88	0.01	49	0.76	-175
600	0.91	174	5.88	86	0.01	51	0.75	-176
700	0.91	172	5.05	83	0.02	53	0.75	-178
800	0.91	170	4.47	81	0.02	55	0.74	-180
900	0.91	167	4.01	79	0.02	55	0.74	179
1000	0.90	165	3.64	76	0.02	54	0.75	177
1100	0.90	163	3.30	74	0.02	52	0.76	175
1200	0.90	161	3.0	71	0.02	51	0.75	173
1300	0.91	159	2.75	69	0.03	50	0.76	172
1400	0.91	156	2.53	67	0.03	51	0.76	171
1500	0.92	155	2.33	65	0.03	52	0.77	170
1600	0.92	153	2.16	64	0.03	52	0.77	169
1700	0.92	152	2.01	62	0.03	51	0.78	168
1800	0.92	152	1.86	61	0.03	48	0.78	168
1900	0.93	151	1.75	60	0.03	49	0.79	168
2000	0.93	152	1.64	60	0.03	51	0.80	168
2100	0.93	151	1.56	59	0.04	52	0.80	169
2200	0.93	151	1.48	58	0.04	52	0.80	169
2300	0.92	151	1.43	57	0.04	52	0.80	170
2400	0.92	151	1.38	57	0.04	52	0.79	171
2500	0.90	152	1.33	57	0.04	51	0.80	172
2600	0.90	152	1.29	56	0.04	50	0.79	173
2700	0.89	152	1.27	55	0.05	50	0.78	173

## 10. Reliability information

**Table 10. Reliability**

Life test	Conditions	Intrinsic failure rate
HTOL	according to JESD85; confidence level 60 %; $T_j = 55\text{ }^{\circ}\text{C}$ ; activation energy = 0.7 eV; acceleration factor determined according to the Arrhenius equation.	4

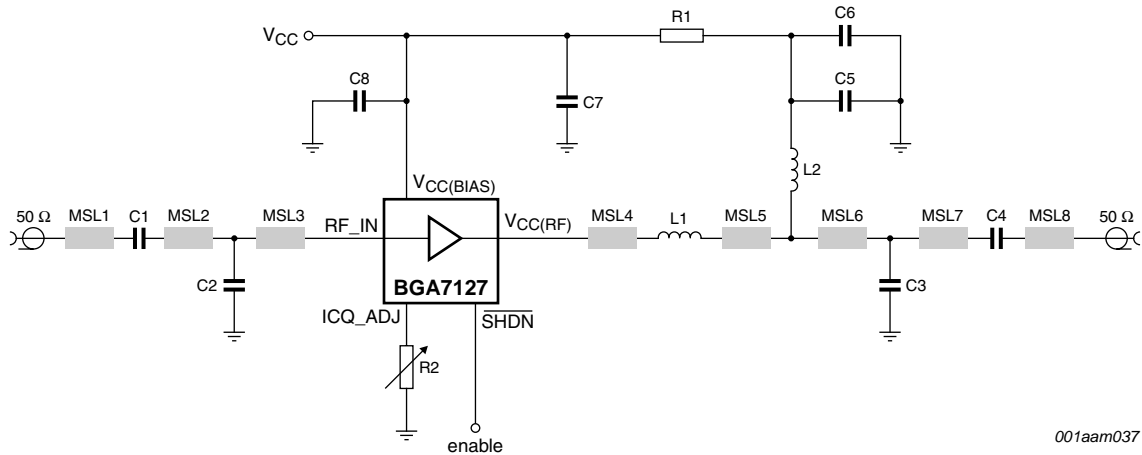
## 11. Moisture sensitivity

**Table 11. Moisture sensitivity level**

Test methodology	Class
JESD-22-A113	1

## 12. Application information

### 12.1 920 MHz to 960 MHz at 5 V; 180 mA

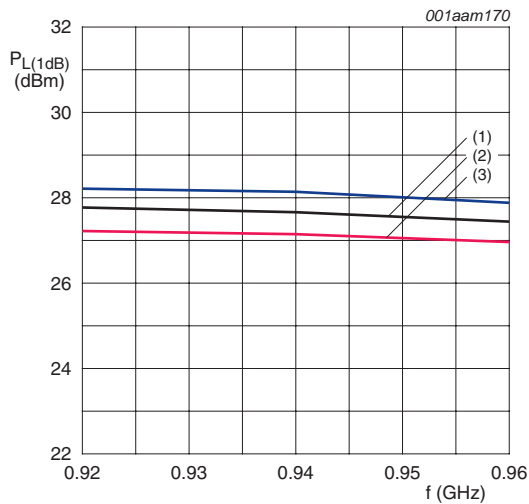


See [Table 12](#) for a list of components.

PCB board specification:

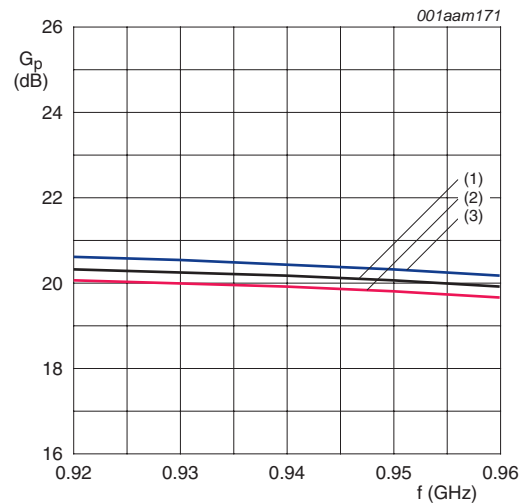
Rogers RO4003C; height = 0.508 mm;  $\epsilon_r = 3.38$ ; copper thickness = 35  $\mu\text{m}$ .

**Fig 5. 920 MHz to 960 MHz application schematic**



- (1)  $T_{\text{case}} = 25\text{ }^\circ\text{C}$
- (2)  $T_{\text{case}} = 85\text{ }^\circ\text{C}$
- (3)  $T_{\text{case}} = -40\text{ }^\circ\text{C}$

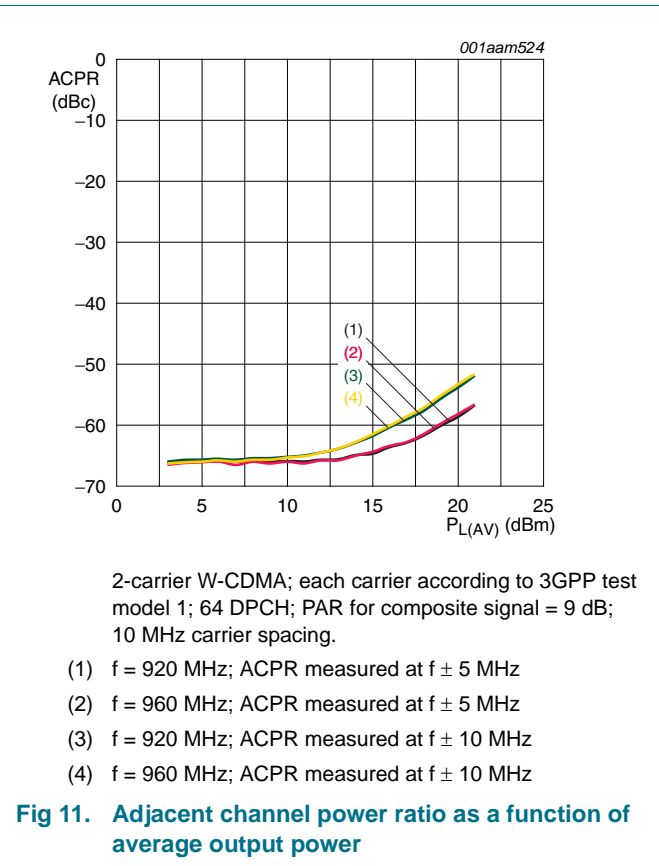
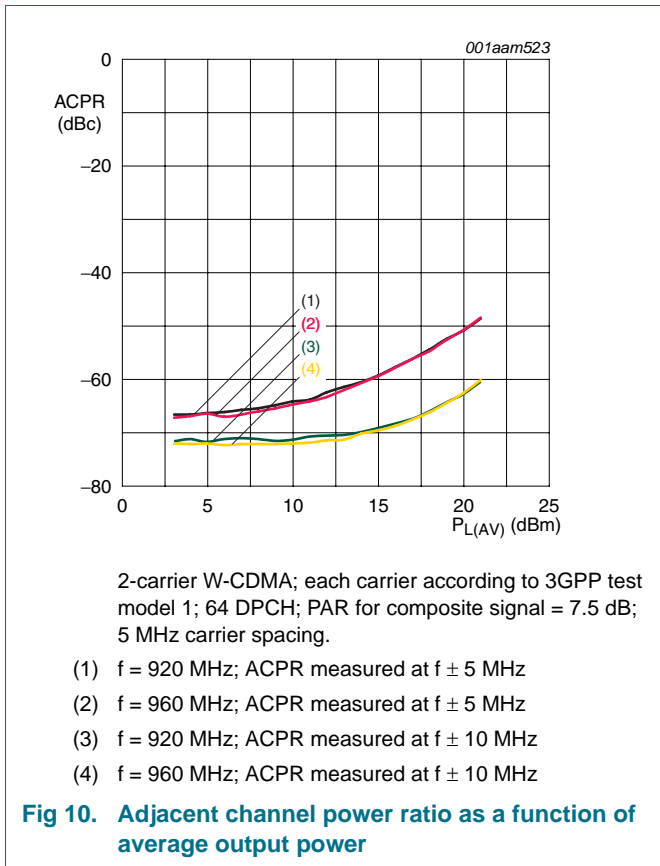
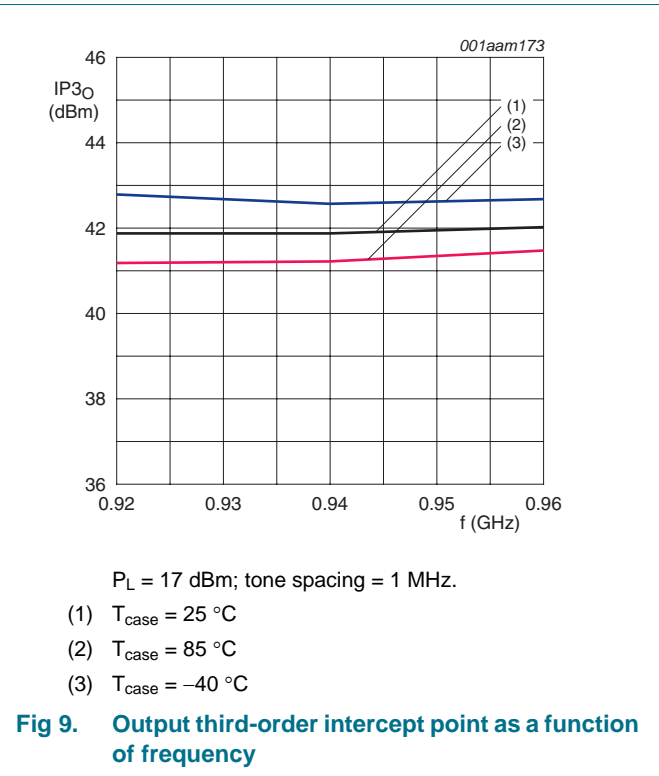
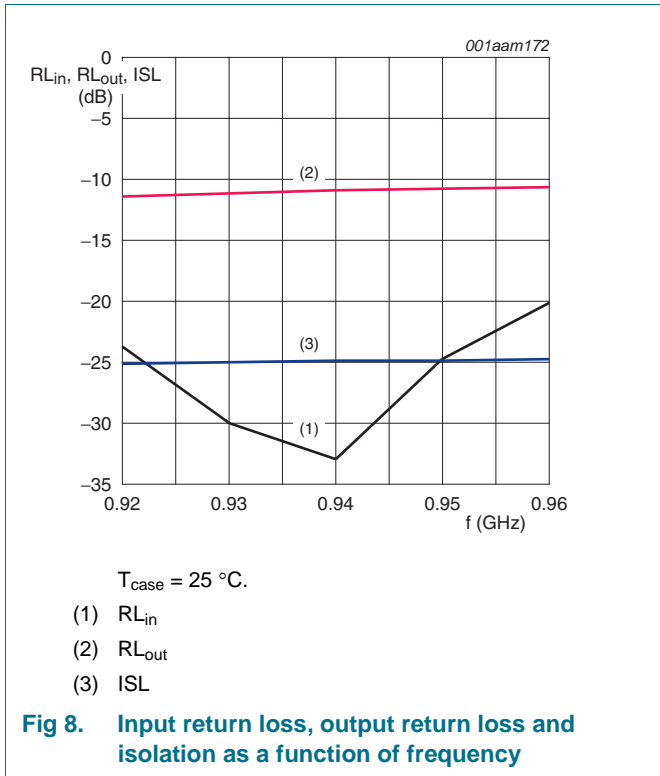
**Fig 6. Output power at 1 dB gain compression as a function of frequency**

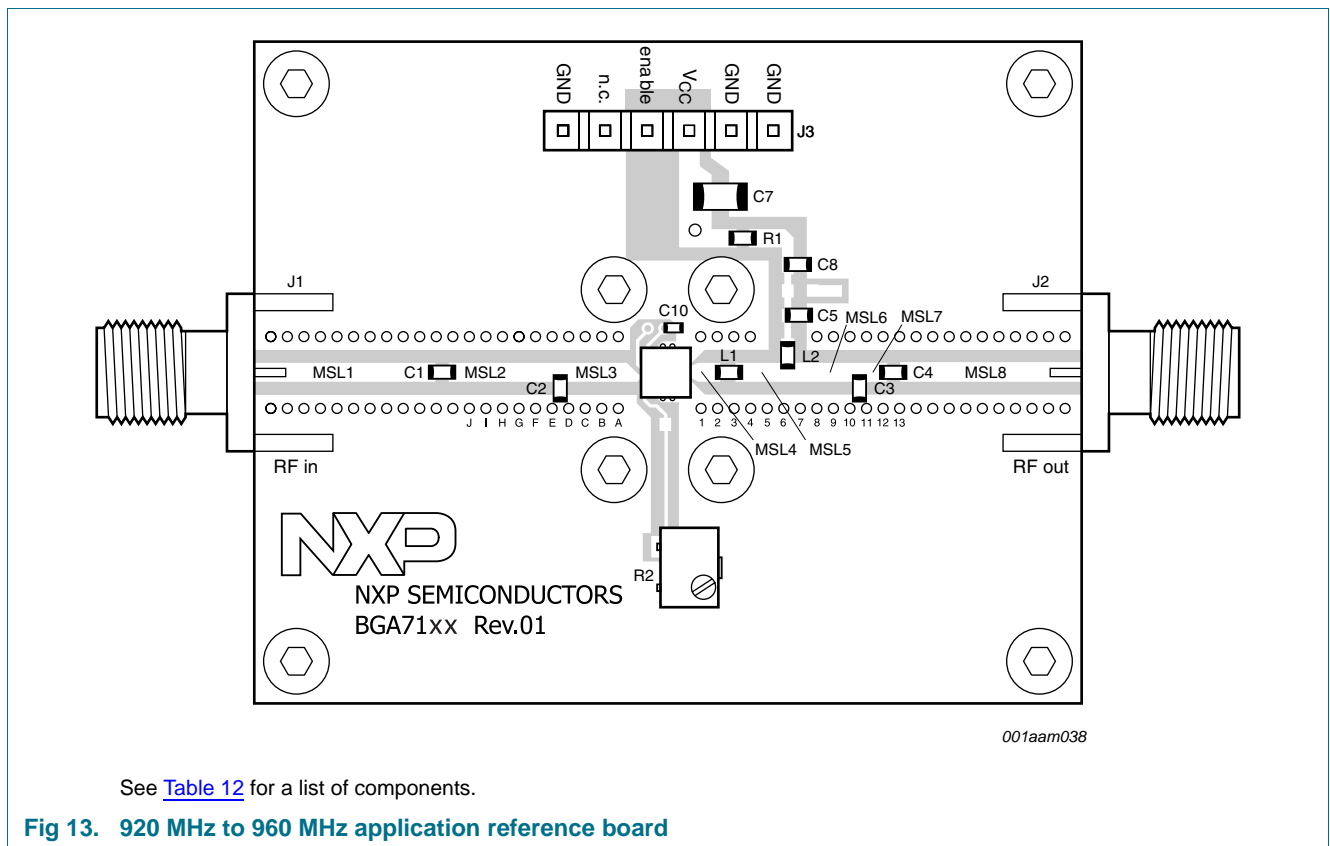
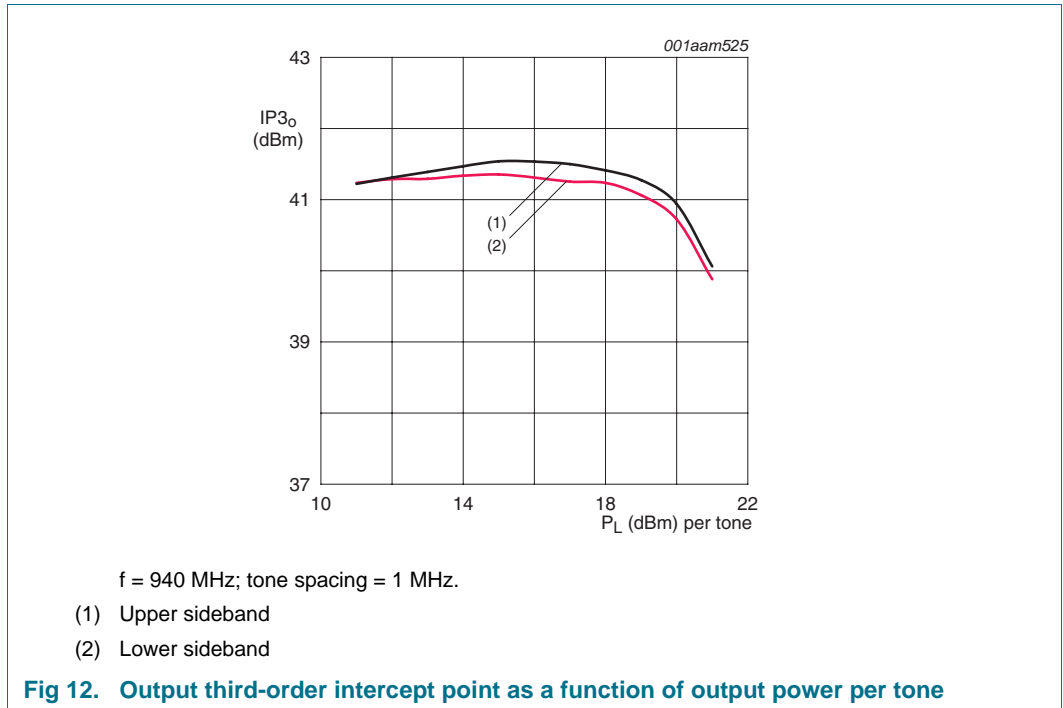


- (1)  $T_{\text{case}} = 25\text{ }^\circ\text{C}$
- (2)  $T_{\text{case}} = 85\text{ }^\circ\text{C}$
- (3)  $T_{\text{case}} = -40\text{ }^\circ\text{C}$

**Fig 7. Power gain as a function of frequency**



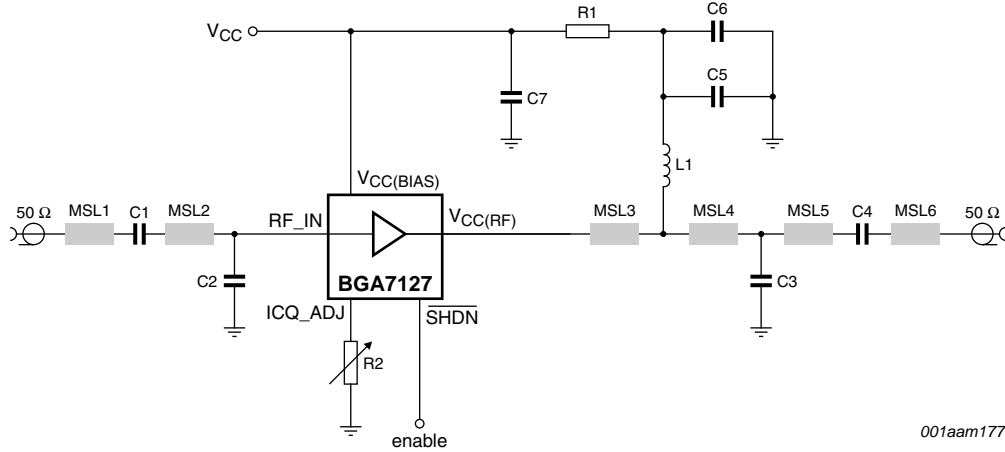




**Table 12. 920 MHz to 960 MHz list of components**See [Figure 5](#) and [Figure 13](#) for component layout.Printed-Circuit Board (PCB): Rogers RO4003C stack; height = 0.508 mm; copper plating thickness = 35  $\mu$ m.

Component	Description	Value	Function	Remarks
C1, C4	capacitor	68 pF	DC blocking	GRM1885C1H680JA01D
C2	capacitor	9.1 pF	input match	Murata GRM1885C1H9R1CZ01D
C3	capacitor	5.1 pF	output match	Murata GRM1885C1H5R1CZ01D
C5	capacitor	10 nF	RF decoupling	Murata GRM1885C1H1R0CZ01D
C6	capacitor	1 $\mu$ F	LF decoupling	AVX 06033D105KAT2A
C7	capacitor	10 $\mu$ F	LF decoupling	AVX 1206ZG106ZAT2A
C8	capacitor	12 pF	noise decoupling	Murata GRM1555C1H120JZ01D
J1, J2	RF connector	SMA		Emerson Network Power 142-0701-841
J3	DC connector	6 pins		MOLEX
L1	inductor	2.2 nH	output match	Tyco Electronics 36501J2N2JTDG
L2	inductor	22 nH	DC Feed	Tyco Electronics 36501J022JTDG
	PCB	RO4003C stack		KOVO
MSL1	micro stripline	1.14 mm $\times$ 0.8 mm $\times$ 10.95 mm	input match	Width (W) $\times$ Spacing (S) $\times$ Length (L)
MSL2	micro stripline	1.14 mm $\times$ 0.8 mm $\times$ 6.8 mm	input match	Width (W) $\times$ Spacing (S) $\times$ Length (L)
MSL3	micro stripline	1.14 mm $\times$ 0.8 mm $\times$ 4.4 mm	input match	Width (W) $\times$ Spacing (S) $\times$ Length (L)
MSL4	micro stripline	1.14 mm $\times$ 0.8 mm $\times$ 2.0 mm	output match	Width (W) $\times$ Spacing (S) $\times$ Length (L)
MSL5	micro stripline	1.14 mm $\times$ 0.8 mm $\times$ 3.2 mm	output match	Width (W) $\times$ Spacing (S) $\times$ Length (L)
MSL6	micro stripline	1.14 mm $\times$ 0.8 mm $\times$ 4.2 mm	output match	Width (W) $\times$ Spacing (S) $\times$ Length (L)
MSL7	micro stripline	1.14 mm $\times$ 0.8 mm $\times$ 1.8 mm	output match	Width (W) $\times$ Spacing (S) $\times$ Length (L)
MSL8	micro stripline	1.14 mm $\times$ 0.8 mm $\times$ 10.95 mm	output match	Width (W) $\times$ Spacing (S) $\times$ Length (L)
R1	resistor	1.8 $\Omega$		Yageo RC0603FR-071R8L
R2	resistor	2 k $\Omega$ trimmer	bias adjustment	Bourns 3214W-1-202E

12.2 1930 MHz to 1990 MHz at 5 V; 180 mA

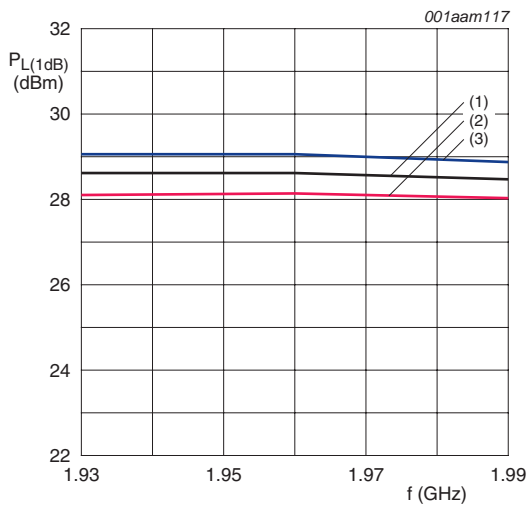


See [Table 13](#) for a list of components.

PCB board specification:

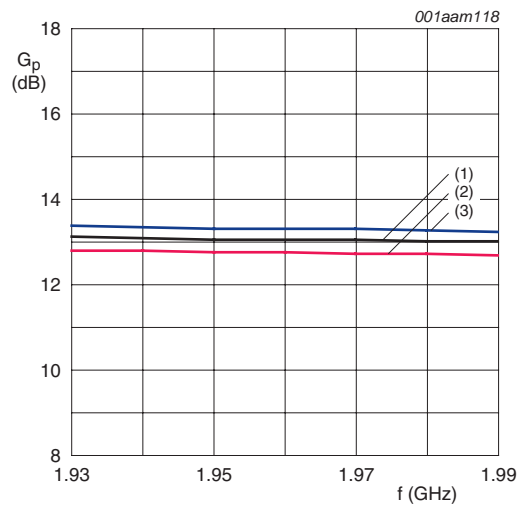
Rogers RO4003C; height = 0.508 mm;  $\epsilon_r = 3.38$ ; copper thickness = 35  $\mu\text{m}$ .

Fig 14. 1930 MHz to 1990 MHz application schematic



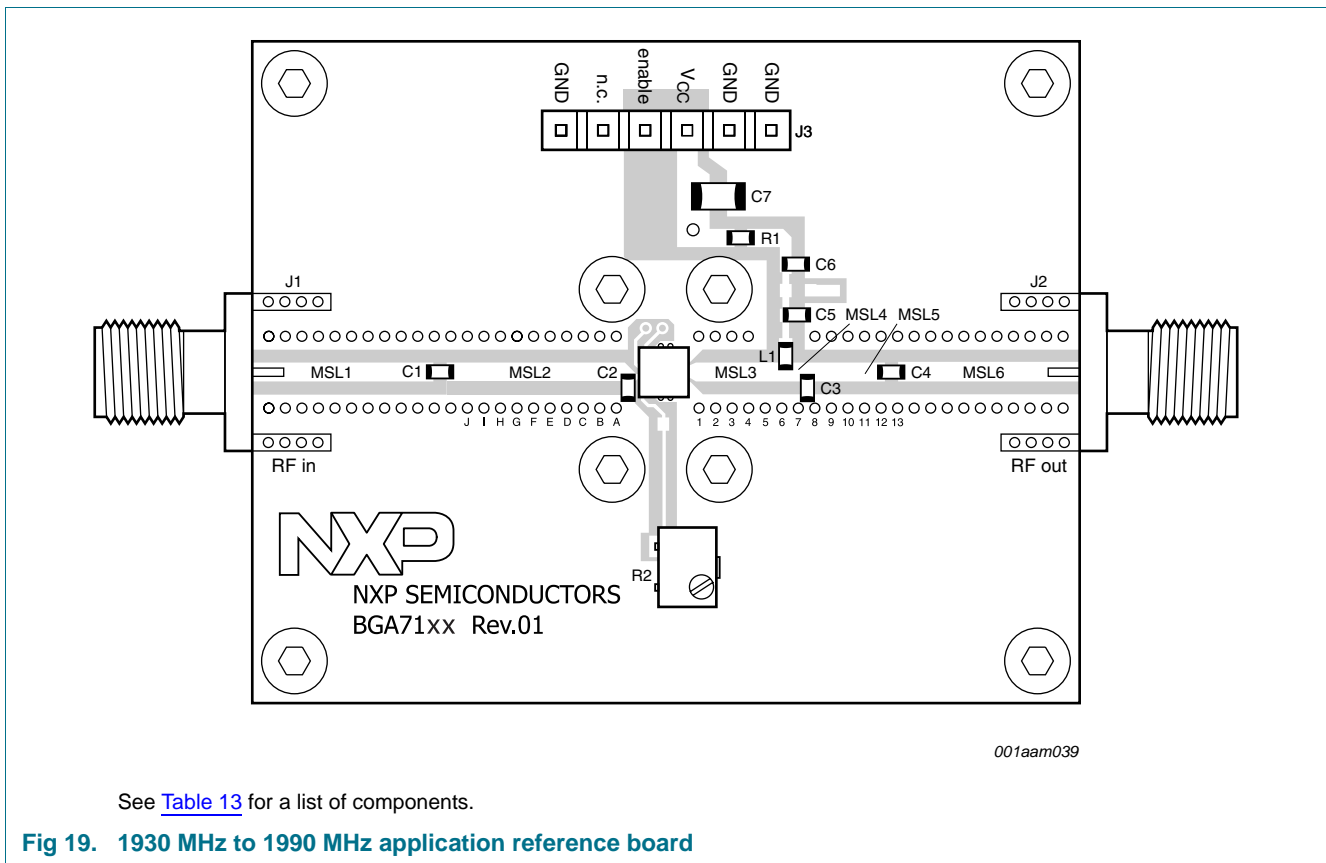
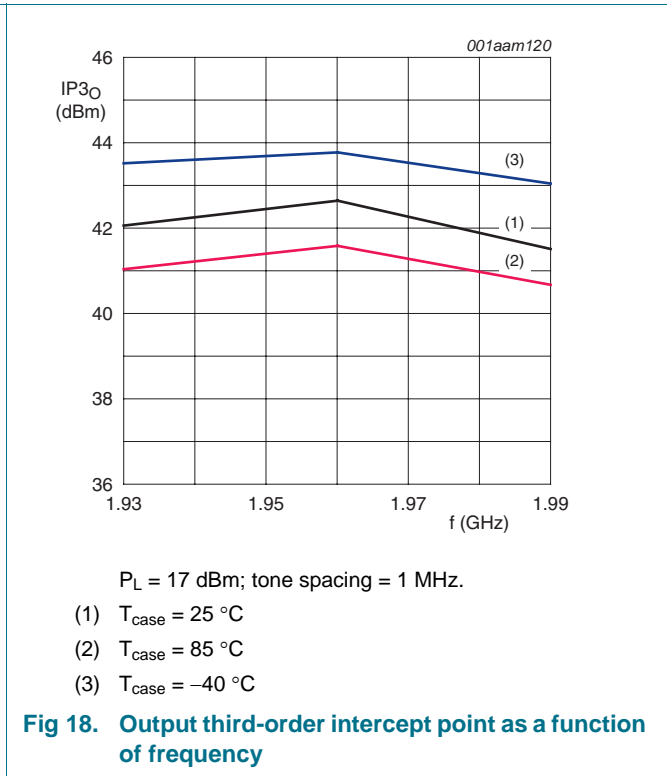
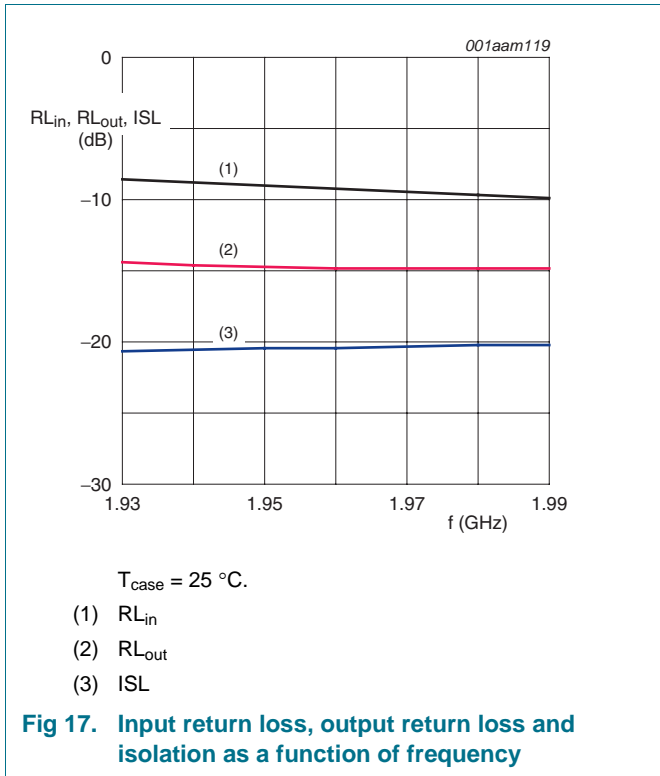
- (1)  $T_{\text{case}} = 25\text{ }^\circ\text{C}$
- (2)  $T_{\text{case}} = 85\text{ }^\circ\text{C}$
- (3)  $T_{\text{case}} = -40\text{ }^\circ\text{C}$

Fig 15. Output power at 1 dB gain compression as a function of frequency



- (1)  $T_{\text{case}} = 25\text{ }^\circ\text{C}$
- (2)  $T_{\text{case}} = 85\text{ }^\circ\text{C}$
- (3)  $T_{\text{case}} = -40\text{ }^\circ\text{C}$

Fig 16. Power gain as a function of frequency



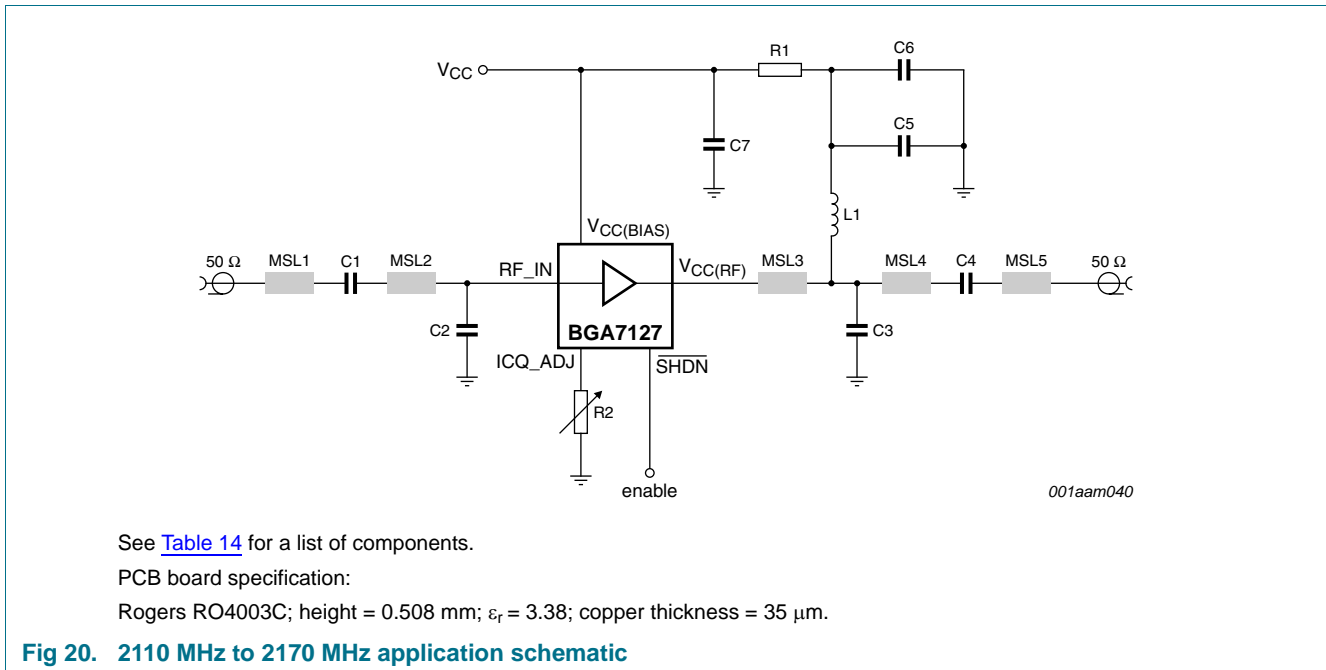
**Table 13. 1930 MHz to 1990 MHz list of components**

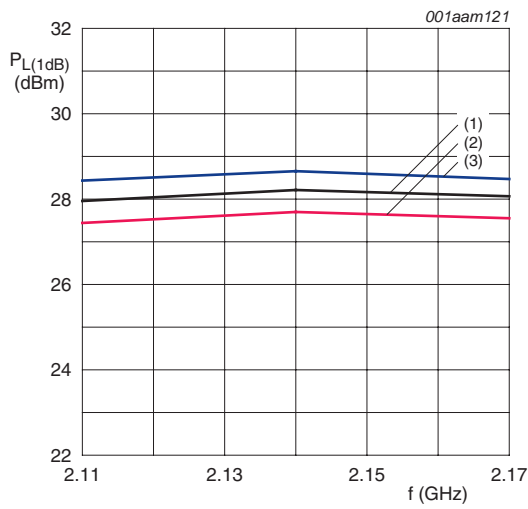
See [Figure 14](#) and [Figure 19](#) for component layout.

Printed-Circuit Board (PCB): Rogers RO4003C stack; height = 0.508 mm; copper plating thickness = 35 μm.

Component	Description	Value	Function	Remarks
C1,C4	capacitor	15 pF	DC blocking	GRM1885C1H150JA01D
C2	capacitor	2.7 pF	input match	Murata, GRM1885C1H2R7CZ01D
C3	capacitor	1.8 pF	output match	Murata, GRM1885C1H1R8CZ01D
C5	capacitor	15 pF	RF decoupling	Murata, GRM1885C1H150JA01D
C6	capacitor	100 nF	LF decoupling	AVX, 0603YC104KAT2A
C7	capacitor	10 μF	LF decoupling	AVX, 1206ZG106ZAT2A
J1,J2	RF connector	SMA		Emerson Network Power, 142-0701-841
J3	DC connector	6 pins		MOLEX
L1	inductor	22 nH	DC Feed	Tyco Electronics, 36501J022JTGD
MSL1	micro stripline	1.14 mm × 0.8 mm × 10.95 mm	input match	Width (W) × Spacing (S) × Length (L)
MSL2	micro stripline	1.14 mm × 0.8 mm × 11.4 mm	input match	Width (W) × Spacing (S) × Length (L)
MSL3	micro stripline	1.14 mm × 0.8 mm × 5.9 mm	output match	Width (W) × Spacing (S) × Length (L)
MSL4	micro stripline	1.14 mm × 0.8 mm × 1.4 mm	output match	Width (W) × Spacing (S) × Length (L)
MSL5	micro stripline	1.14 mm × 0.8 mm × 4.6 mm	output match	Width (W) × Spacing (S) × Length (L)
MSL6	micro stripline	1.14 mm × 0.8 mm × 10.95 mm	output match	Width (W) × Spacing (S) × Length (L)
R1	resistor	1 Ω		Yageo, RC0603FR-071RL
R2	resistor	2 kΩ trimmer	bias adjustment	Bourns, 3214W-1-202E

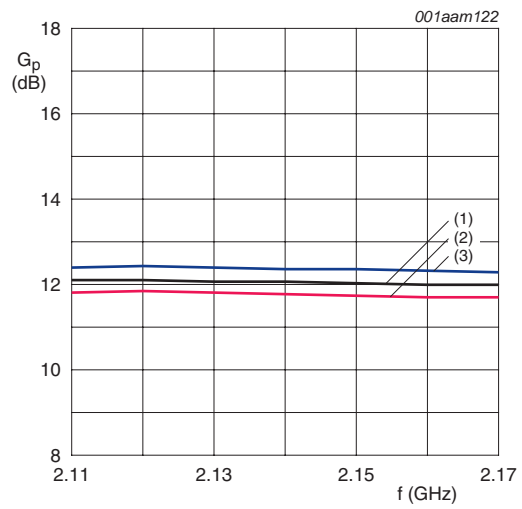
**12.3 2110 MHz to 2170 MHz at 5 V; 180 mA**





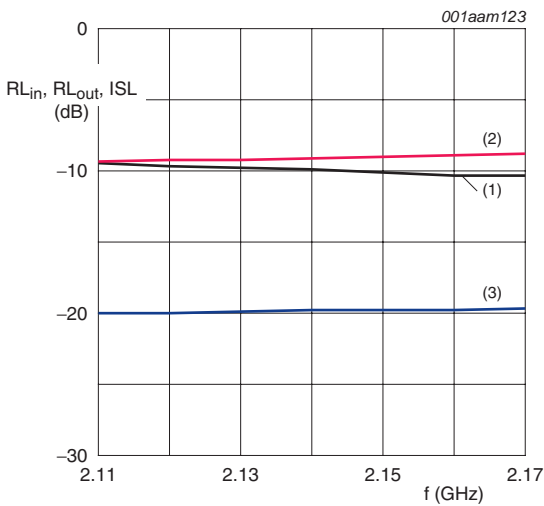
- (1)  $T_{case} = 25\text{ }^{\circ}\text{C}$
- (2)  $T_{case} = 85\text{ }^{\circ}\text{C}$
- (3)  $T_{case} = -40\text{ }^{\circ}\text{C}$

Fig 21. Output power at 1 dB gain compression as a function of frequency



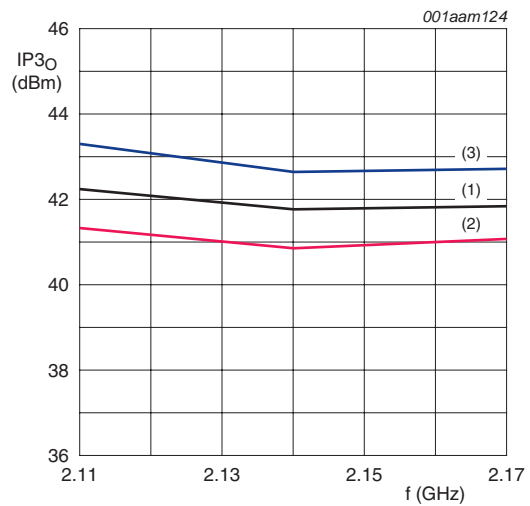
- (1)  $T_{case} = 25\text{ }^{\circ}\text{C}$
- (2)  $T_{case} = 85\text{ }^{\circ}\text{C}$
- (3)  $T_{case} = -40\text{ }^{\circ}\text{C}$

Fig 22. Power gain as a function of frequency



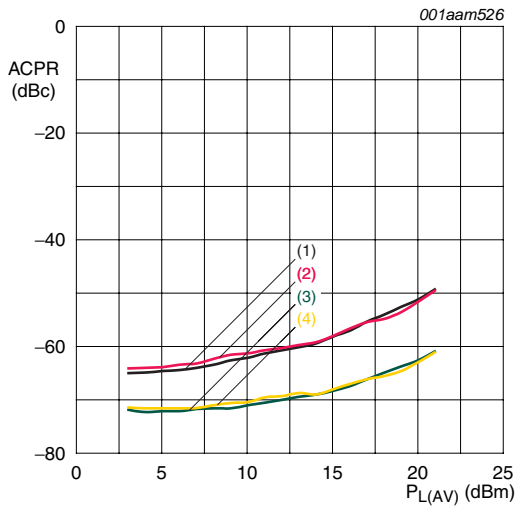
- $T_{case} = 25\text{ }^{\circ}\text{C}$ .
- (1)  $RL_{in}$
  - (2)  $RL_{out}$
  - (3) ISL

Fig 23. Input return loss, output return loss and isolation as a function of frequency



- $P_L = 17\text{ dBm}$ ; tone spacing = 1 MHz.
- (1)  $T_{case} = 25\text{ }^{\circ}\text{C}$
  - (2)  $T_{case} = 85\text{ }^{\circ}\text{C}$
  - (3)  $T_{case} = -40\text{ }^{\circ}\text{C}$

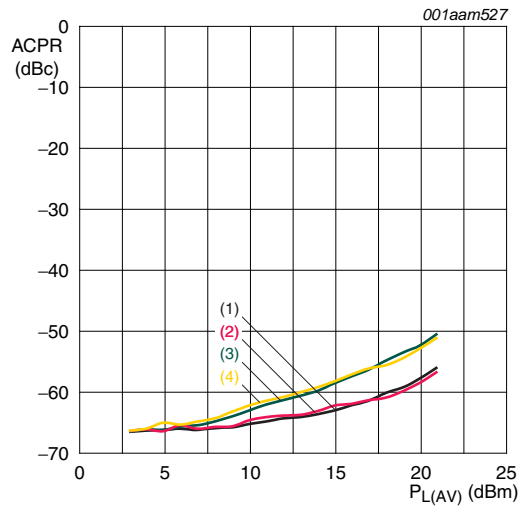
Fig 24. Output third-order intercept point as a function of frequency



2-carrier W-CDMA; each carrier according to 3GPP test model 1; 64 DPCH; PAR for composite signal = 7.5 dB; 5 MHz carrier spacing.

- (1)  $f = 2110$  MHz; ACPR measured at  $f \pm 5$  MHz
- (2)  $f = 2170$  MHz; ACPR measured at  $f \pm 5$  MHz
- (3)  $f = 2110$  MHz; ACPR measured at  $f \pm 10$  MHz
- (4)  $f = 2170$  MHz; ACPR measured at  $f \pm 10$  MHz

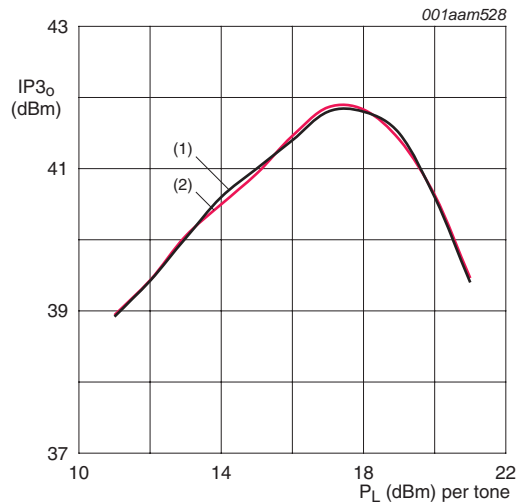
**Fig 25. Adjacent channel power ratio as a function of average output power**



2-carrier W-CDMA; each carrier according to 3GPP test model 1; 64 DPCH; PAR for composite signal = 9 dB; 10 MHz carrier spacing.

- (1)  $f = 2110$  MHz; ACPR measured at  $f \pm 5$  MHz
- (2)  $f = 2170$  MHz; ACPR measured at  $f \pm 5$  MHz
- (3)  $f = 2110$  MHz; ACPR measured at  $f \pm 10$  MHz
- (4)  $f = 2170$  MHz; ACPR measured at  $f \pm 10$  MHz

**Fig 26. Adjacent channel power ratio as a function of average output power**

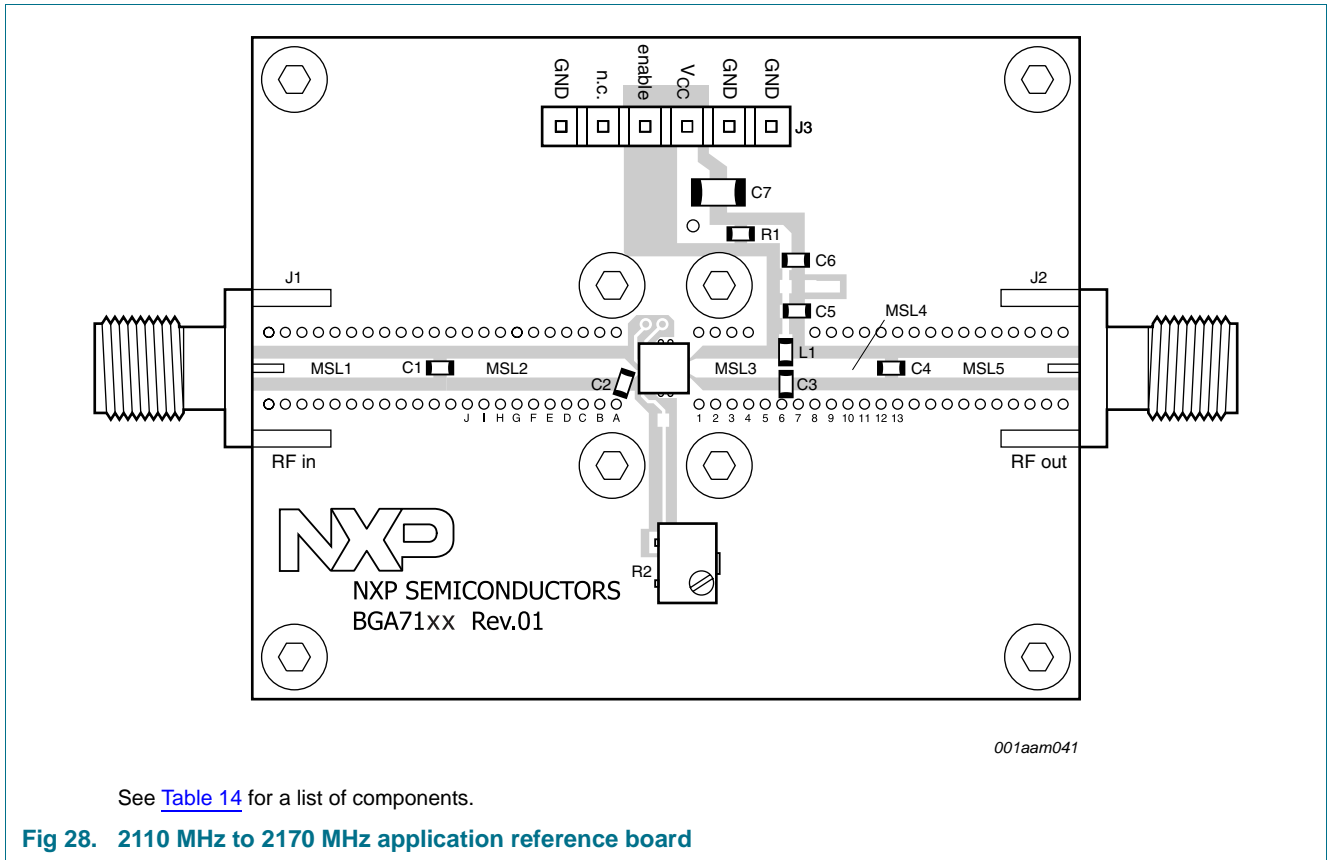


$f = 2140$  MHz; tone spacing = 1 MHz.

- (1) Upper sideband
- (2) Lower sideband

**Fig 27. Output third-order intercept point as a function of output power per tone**





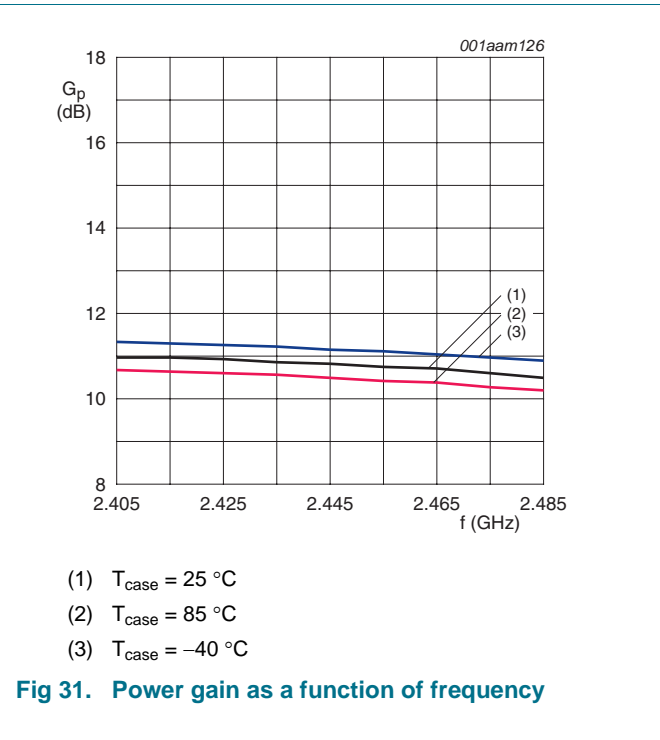
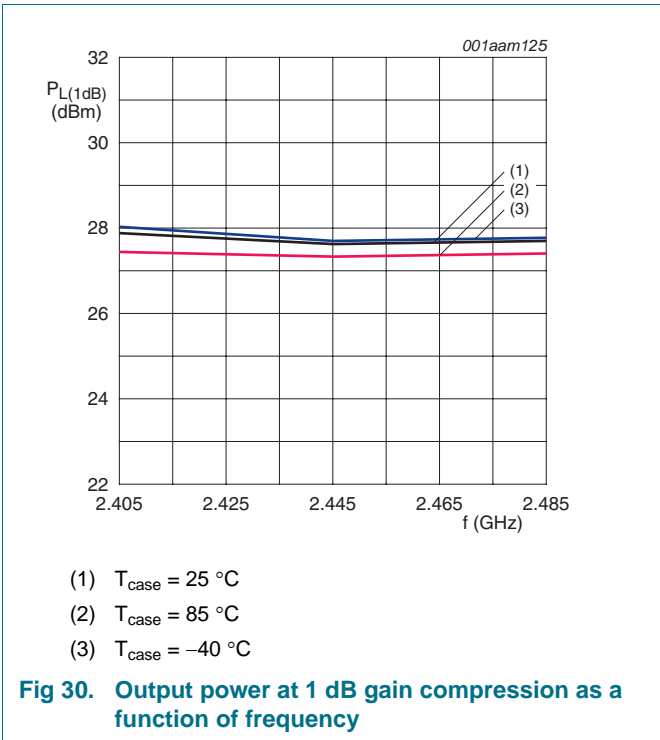
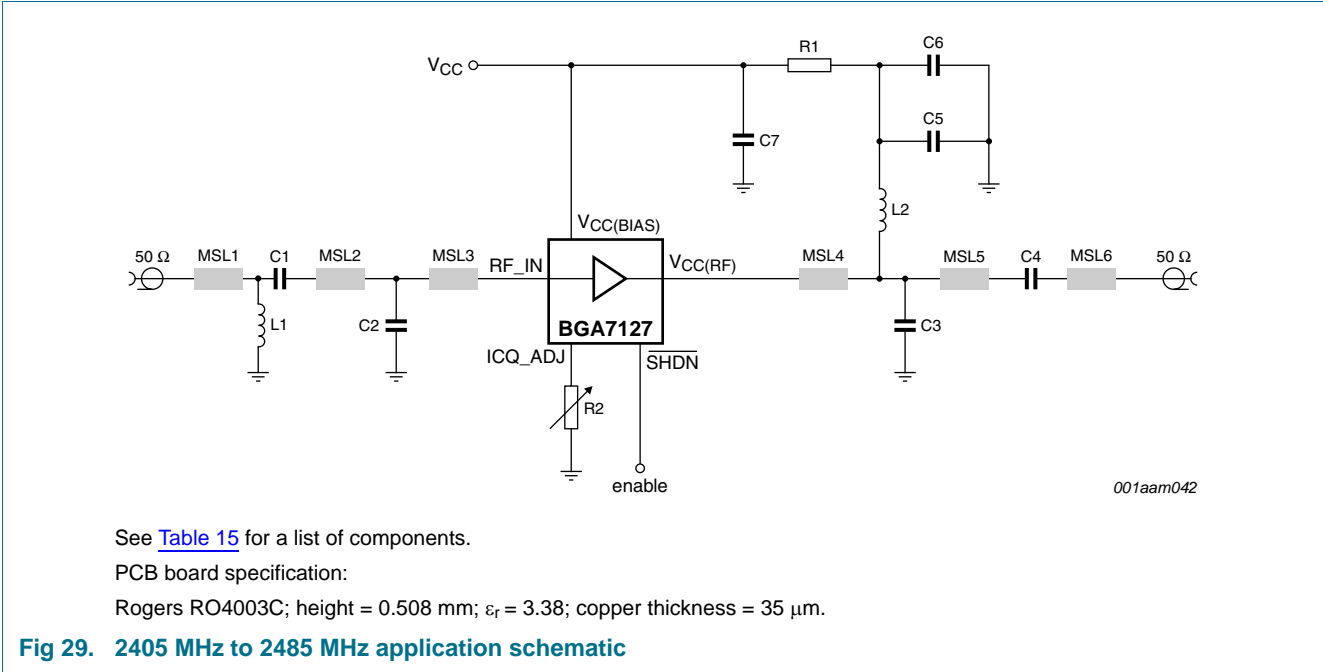
**Table 14. 2110 MHz to 2170 MHz list of components**

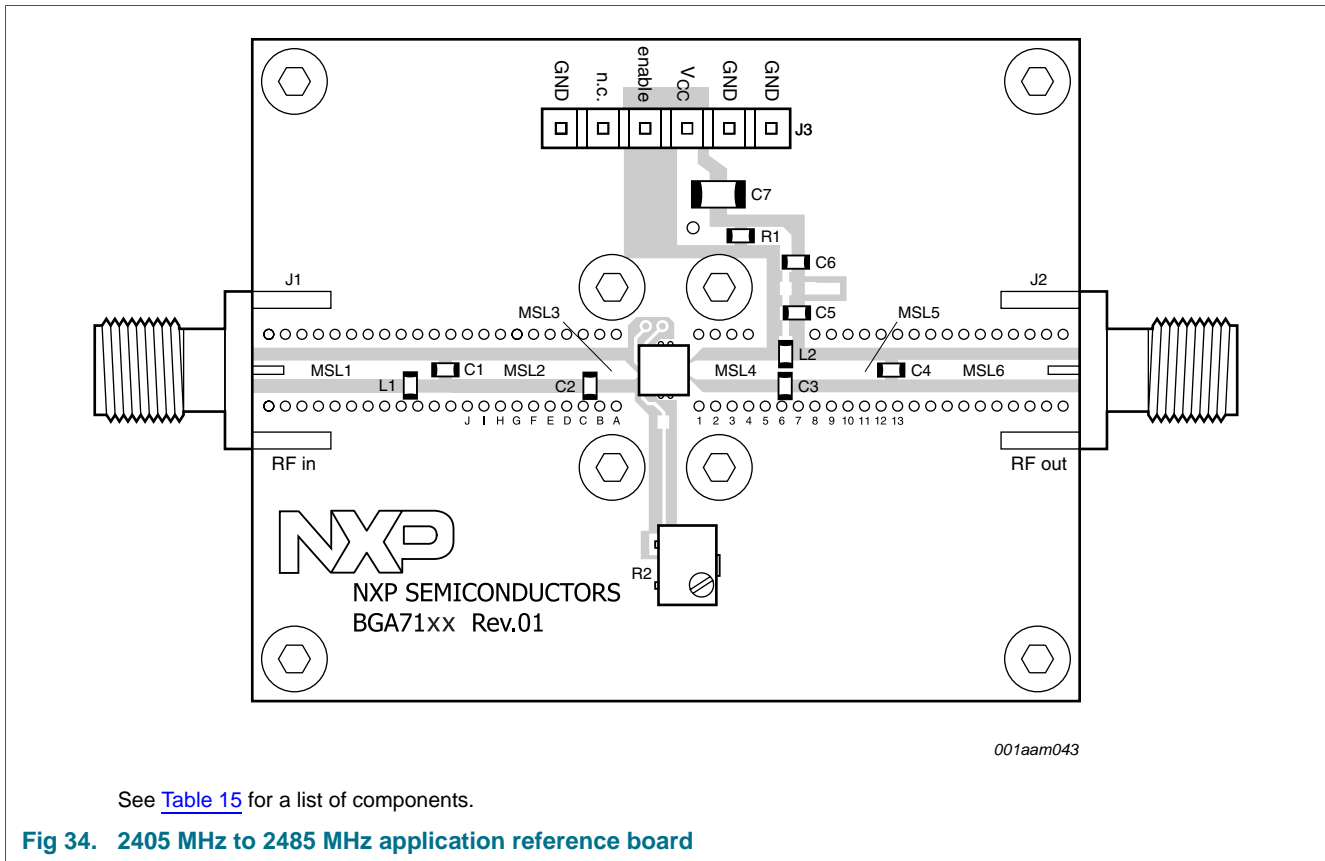
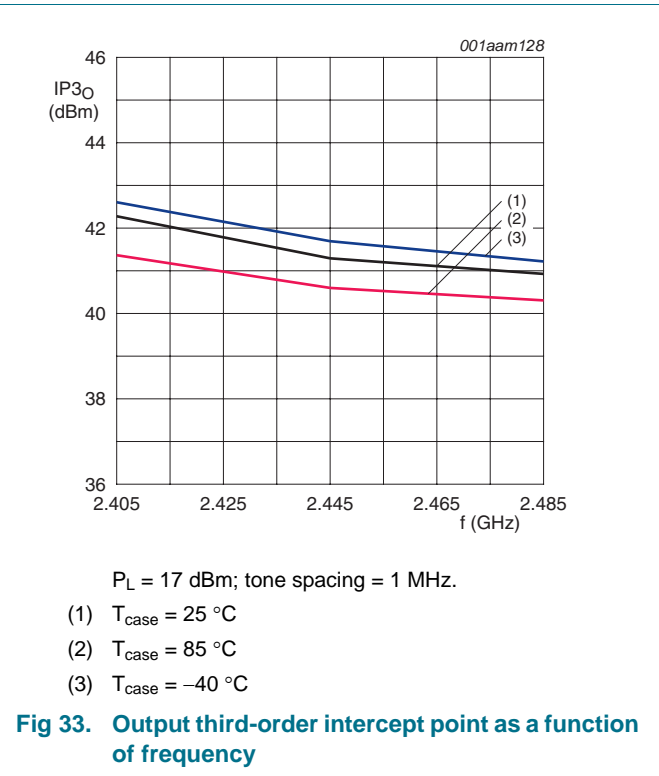
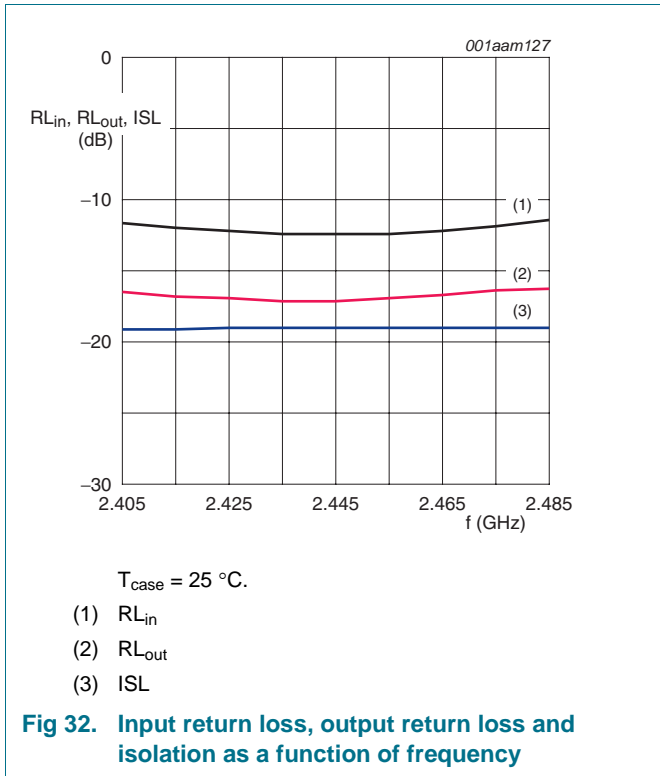
See [Figure 20](#) and [Figure 28](#) for component layout.

Printed-Circuit Board (PCB): Rogers RO4003C stack; height = 0.508 mm; copper plating thickness = 35 μm.

Component	Description	Value	Function	Remarks
C1,C4	capacitor	15 pF	DC blocking	Murata, GRM1885C1H150JA01D
C2	capacitor	2.4 pF	input match	Murata, GRM1885C1H2R4CZ01D
C3	capacitor	1.5 pF	output match	Murata, GRM1885C1H1R5CZ01D
C5	capacitor	15 pF	RF decoupling	Murata, GRM1885C1H150JA01D
C6	capacitor	100 nF	LF decoupling	AVX, 0603YC104KAT2A
C7	capacitor	10 μF	LF decoupling	AVX, 1206ZG106ZAT2A
J1,J2	RF connector	SMA		Emerson Network Power, 142-0701-841
J3	DC connector	6 pins		MOLEX
L1	inductor	22 nH	DC Feed	Tyco Electronics, 36501J022JTDG
MSL1	micro stripline	1.14 mm × 0.8 mm × 10.95 mm	input match	Width (W) × Spacing (S) × Length (L)
MSL2	micro stripline	1.14 mm × 0.8 mm × 11.2 mm	input match	Width (W) × Spacing (S) × Length (L)
MSL3	micro stripline	1.14 mm × 0.8 mm × 5.9 mm	output match	Width (W) × Spacing (S) × Length (L)
MSL4	micro stripline	1.14 mm × 0.8 mm × 6.0 mm	output match	Width (W) × Spacing (S) × Length (L)
MSL5	micro stripline	1.14 mm × 0.8 mm × 10.95 mm	output match	Width (W) × Spacing (S) × Length (L)
R1	resistor	1 Ω		Yageo, RC0603FR-071RL
R2	resistor	2 kΩ trimmer	bias adjustment	Bourns, 3214W-1-202E

**12.4 2405 MHz to 2485 MHz at 5 V; 180 mA**





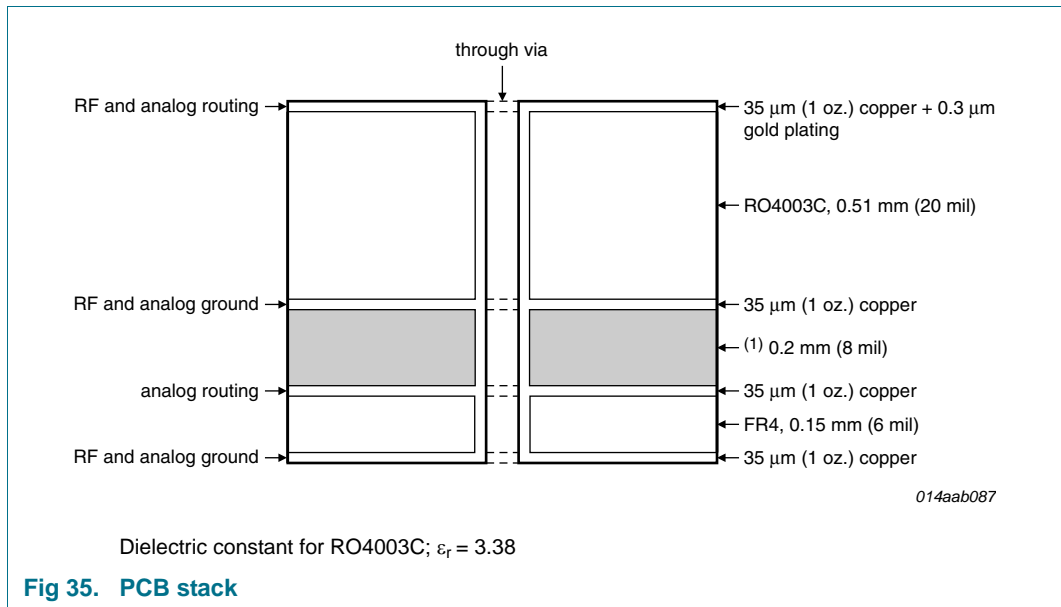
**Table 15. 2405 MHz to 2485 MHz list of components**

See [Figure 29](#) and [Figure 34](#) for component layout.

Printed-Circuit Board (PCB): Rogers RO4003C stack; height = 0.508 mm; copper plating thickness = 35  $\mu$ m.

Component	Description	Value	Function	Remarks
C1,C4	capacitor	15 pF	DC blocking	GRM1885C1H150JA01D
C2	capacitor	1.5 pF	input match	Murata, GRM1885C1H1R5CZ01D
C3	capacitor	1.5 pF	output match	Murata, GRM1885C1H1R5CZ01D
C5	capacitor	15 pF	RF decoupling	Murata, GRM1885C1H150JA01D
C6	capacitor	100 nF	LF decoupling	AVX, 0603YC104KAT2A
C7	capacitor	10 $\mu$ F	LF decoupling	AVX, 1206ZG106ZAT2A
L1	inductor	3.3 nH	input match	Tyco Electronics, 36501J3N3JTDG
L2	inductor	22 nH	DC Feed	Tyco Electronics, 36501J022JTDG
MSL1	micro stripline	1.14 mm $\times$ 0.8 mm $\times$ 10.95 mm	input match	Width (W) $\times$ Spacing (S) $\times$ Length (L)
MSL2	micro stripline	1.14 mm $\times$ 0.8 mm $\times$ 8.6 mm	input match	Width (W) $\times$ Spacing (S) $\times$ Length (L)
MSL3	micro stripline	1.14 mm $\times$ 0.8 mm $\times$ 2.8 mm	input match	Width (W) $\times$ Spacing (S) $\times$ Length (L)
MSL4	micro stripline	1.14 mm $\times$ 0.8 mm $\times$ 6.0 mm	output match	Width (W) $\times$ Spacing (S) $\times$ Length (L)
MSL5	micro stripline	1.14 mm $\times$ 0.8 mm $\times$ 5.9 mm	output match	Width (W) $\times$ Spacing (S) $\times$ Length (L)
MSL6	micro stripline	1.14 mm $\times$ 0.8 mm $\times$ 10.95 mm	output match	Width (W) $\times$ Spacing (S) $\times$ Length (L)
R1	resistor	1 $\Omega$		Yageo, RC0603FR-071RL
R2	resistor	2 k $\Omega$ trimmer	bias adjustment	Bourns, 3214W-1-202E

**12.5 PCB stack**

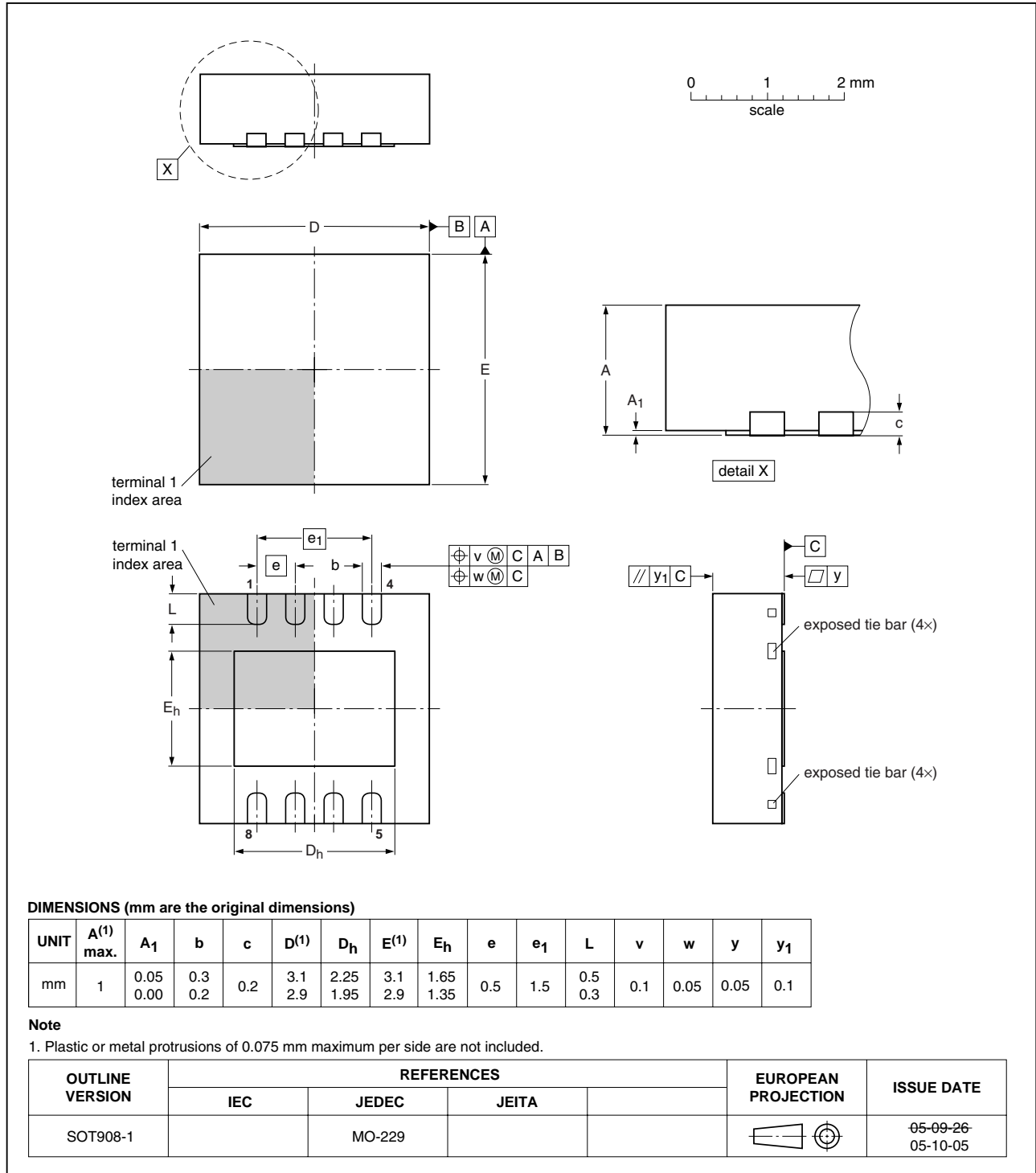


**Fig 35. PCB stack**

### 13. Package outline

**HVSON8: plastic thermal enhanced very thin small outline package; no leads; 8 terminals; body 3 x 3 x 0.85 mm**

**SOT908-1**



**Fig 36. Package outline SOT908-1 (HVSON8)**

## 14. Abbreviations

Table 16. Abbreviations

Acronym	Description
3GPP	3rd Generation Partnership Project
CPE	Customer-Premises Equipment
DC	Direct Current
DPCH	Dedicated Physical CHannel
ESD	ElectroStatic Discharge
HTOL	High Temperature Operating Life
ISM	Industrial, Scientific and Medical
MMIC	Monolithic Microwave Integrated Circuit
MoCA	Multimedia over Coax Alliance
RFID	Radio Frequency IDentification
SMA	SubMiniature version A
TX	Transmit
W-CDMA	Wideband Code Division Multiple Access
WLAN	Wireless Local Area Network

## 15. Revision history

Table 17. Revision history

Document ID	Release date	Data sheet status	Change notice	Supersedes
BGA7127 v.3	20101203	Product data sheet	-	BGA7127 v.2
Modifications:	<ul style="list-style-type: none"> <li>• <a href="#">Figure 10 on page 9</a>: Figure has been changed</li> <li>• <a href="#">Figure 11 on page 9</a>: Figure has been changed</li> <li>• <a href="#">Figure 25 on page 16</a>: Figure has been changed</li> <li>• <a href="#">Figure 26 on page 16</a>: Figure has been changed</li> <li>• Some page- layout enhancements have been made</li> </ul>			
BGA7127 v.2	20100913	Product data sheet	-	BGA7127 v.1
BGA7127 v.1	20100726	Product data sheet	-	-

## 16. Legal information

### 16.1 Data sheet status

Document status <sup>[1][2]</sup>	Product status <sup>[3]</sup>	Definition
Objective [short] data sheet	Development	This document contains data from the objective specification for product development.
Preliminary [short] data sheet	Qualification	This document contains data from the preliminary specification.
Product [short] data sheet	Production	This document contains the product specification.

[1] Please consult the most recently issued document before initiating or completing a design.

[2] The term 'short data sheet' is explained in section "Definitions".

[3] The product status of device(s) described in this document may have changed since this document was published and may differ in case of multiple devices. The latest product status information is available on the Internet at URL <http://www.nxp.com>.

### 16.2 Definitions

**Draft** — The document is a draft version only. The content is still under internal review and subject to formal approval, which may result in modifications or additions. NXP Semiconductors does not give any representations or warranties as to the accuracy or completeness of information included herein and shall have no liability for the consequences of use of such information.

**Short data sheet** — A short data sheet is an extract from a full data sheet with the same product type number(s) and title. A short data sheet is intended for quick reference only and should not be relied upon to contain detailed and full information. For detailed and full information see the relevant full data sheet, which is available on request via the local NXP Semiconductors sales office. In case of any inconsistency or conflict with the short data sheet, the full data sheet shall prevail.

**Product specification** — The information and data provided in a Product data sheet shall define the specification of the product as agreed between NXP Semiconductors and its customer, unless NXP Semiconductors and customer have explicitly agreed otherwise in writing. In no event however, shall an agreement be valid in which the NXP Semiconductors product is deemed to offer functions and qualities beyond those described in the Product data sheet.

### 16.3 Disclaimers

**Limited warranty and liability** — Information in this document is believed to be accurate and reliable. However, NXP Semiconductors does not give any representations or warranties, expressed or implied, as to the accuracy or completeness of such information and shall have no liability for the consequences of use of such information.

In no event shall NXP Semiconductors be liable for any indirect, incidental, punitive, special or consequential damages (including - without limitation - lost profits, lost savings, business interruption, costs related to the removal or replacement of any products or rework charges) whether or not such damages are based on tort (including negligence), warranty, breach of contract or any other legal theory.

Notwithstanding any damages that customer might incur for any reason whatsoever, NXP Semiconductors' aggregate and cumulative liability towards customer for the products described herein shall be limited in accordance with the *Terms and conditions of commercial sale* of NXP Semiconductors.

**Right to make changes** — NXP Semiconductors reserves the right to make changes to information published in this document, including without limitation specifications and product descriptions, at any time and without notice. This document supersedes and replaces all information supplied prior to the publication hereof.

**Suitability for use** — NXP Semiconductors products are not designed, authorized or warranted to be suitable for use in life support, life-critical or safety-critical systems or equipment, nor in applications where failure or

malfunction of an NXP Semiconductors product can reasonably be expected to result in personal injury, death or severe property or environmental damage. NXP Semiconductors accepts no liability for inclusion and/or use of NXP Semiconductors products in such equipment or applications and therefore such inclusion and/or use is at the customer's own risk.

**Applications** — Applications that are described herein for any of these products are for illustrative purposes only. NXP Semiconductors makes no representation or warranty that such applications will be suitable for the specified use without further testing or modification.

Customers are responsible for the design and operation of their applications and products using NXP Semiconductors products, and NXP Semiconductors accepts no liability for any assistance with applications or customer product design. It is customer's sole responsibility to determine whether the NXP Semiconductors product is suitable and fit for the customer's applications and products planned, as well as for the planned application and use of customer's third party customer(s). Customers should provide appropriate design and operating safeguards to minimize the risks associated with their applications and products.

NXP Semiconductors does not accept any liability related to any default, damage, costs or problem which is based on any weakness or default in the customer's applications or products, or the application or use by customer's third party customer(s). Customer is responsible for doing all necessary testing for the customer's applications and products using NXP Semiconductors products in order to avoid a default of the applications and the products or of the application or use by customer's third party customer(s). NXP does not accept any liability in this respect.

**Limiting values** — Stress above one or more limiting values (as defined in the Absolute Maximum Ratings System of IEC 60134) will cause permanent damage to the device. Limiting values are stress ratings only and (proper) operation of the device at these or any other conditions above those given in the Recommended operating conditions section (if present) or the Characteristics sections of this document is not warranted. Constant or repeated exposure to limiting values will permanently and irreversibly affect the quality and reliability of the device.

**Terms and conditions of commercial sale** — NXP Semiconductors products are sold subject to the general terms and conditions of commercial sale, as published at <http://www.nxp.com/profile/terms>, unless otherwise agreed in a valid written individual agreement. In case an individual agreement is concluded only the terms and conditions of the respective agreement shall apply. NXP Semiconductors hereby expressly objects to applying the customer's general terms and conditions with regard to the purchase of NXP Semiconductors products by customer.

**No offer to sell or license** — Nothing in this document may be interpreted or construed as an offer to sell products that is open for acceptance or the grant, conveyance or implication of any license under any copyrights, patents or other industrial or intellectual property rights.

**Export control** — This document as well as the item(s) described herein may be subject to export control regulations. Export might require a prior authorization from national authorities.

**Quick reference data** — The Quick reference data is an extract of the product data given in the Limiting values and Characteristics sections of this document, and as such is not complete, exhaustive or legally binding.

**Non-automotive qualified products** — Unless this data sheet expressly states that this specific NXP Semiconductors product is automotive qualified, the product is not suitable for automotive use. It is neither qualified nor tested in accordance with automotive testing or application requirements. NXP Semiconductors accepts no liability for inclusion and/or use of non-automotive qualified products in automotive equipment or applications.

In the event that customer uses the product for design-in and use in automotive applications to automotive specifications and standards, customer (a) shall use the product without NXP Semiconductors' warranty of the

product for such automotive applications, use and specifications, and (b) whenever customer uses the product for automotive applications beyond NXP Semiconductors' specifications such use shall be solely at customer's own risk, and (c) customer fully indemnifies NXP Semiconductors for any liability, damages or failed product claims resulting from customer design and use of the product for automotive applications beyond NXP Semiconductors' standard warranty and NXP Semiconductors' product specifications.

## 16.4 Trademarks

Notice: All referenced brands, product names, service names and trademarks are the property of their respective owners.

## 17. Contact information

For more information, please visit: <http://www.nxp.com>

For sales office addresses, please send an email to: [salesaddresses@nxp.com](mailto:salesaddresses@nxp.com)



**18. Contents**

**1 Product profile . . . . . 1**

1.1 General description . . . . . 1

1.2 Features and benefits . . . . . 1

1.3 Applications . . . . . 1

1.4 Quick reference data . . . . . 1

**2 Pinning information . . . . . 2**

2.1 Pinning . . . . . 2

2.2 Pin description . . . . . 2

**3 Ordering information . . . . . 2**

**4 Functional diagram . . . . . 3**

**5 Shutdown control . . . . . 3**

**6 Limiting values . . . . . 4**

**7 Thermal characteristics . . . . . 5**

**8 Static characteristics . . . . . 5**

8.1 Supply current adjustment . . . . . 5

**9 Dynamic characteristics . . . . . 6**

9.1 Scattering parameters . . . . . 7

**10 Reliability information . . . . . 7**

**11 Moisture sensitivity . . . . . 7**

**12 Application information . . . . . 8**

12.1 920 MHz to 960 MHz at 5 V; 180 mA . . . . . 8

12.2 1930 MHz to 1990 MHz at 5 V; 180 mA . . . . . 12

12.3 2110 MHz to 2170 MHz at 5 V; 180 mA . . . . . 14

12.4 2405 MHz to 2485 MHz at 5 V; 180 mA . . . . . 18

12.5 PCB stack . . . . . 20

**13 Package outline . . . . . 21**

**14 Abbreviations . . . . . 22**

**15 Revision history . . . . . 22**

**16 Legal information . . . . . 23**

16.1 Data sheet status . . . . . 23

16.2 Definitions . . . . . 23

16.3 Disclaimers . . . . . 23

16.4 Trademarks . . . . . 24

**17 Contact information . . . . . 24**

**18 Contents . . . . . 25**

Please be aware that important notices concerning this document and the product(s) described herein, have been included in section 'Legal information'.

# Mouser Electronics

Authorized Distributor

Click to View Pricing, Inventory, Delivery & Lifecycle Information:

[NXP:](#)

[BGA7127,118](#)

## Данный компонент на территории Российской Федерации

### Вы можете приобрести в компании MosChip.

Для оперативного оформления запроса Вам необходимо перейти по данной ссылке:

<http://moschip.ru/get-element>

Вы можете разместить у нас заказ для любого Вашего проекта, будь то серийное производство или разработка единичного прибора.

В нашем ассортименте представлены ведущие мировые производители активных и пассивных электронных компонентов.

Нашей специализацией является поставка электронной компонентной базы двойного назначения, продукции таких производителей как XILINX, Intel (ex.ALTERA), Vicor, Microchip, Texas Instruments, Analog Devices, Mini-Circuits, Amphenol, Glenair.

Сотрудничество с глобальными дистрибьюторами электронных компонентов, предоставляет возможность заказывать и получать с международных складов практически любой перечень компонентов в оптимальные для Вас сроки.

На всех этапах разработки и производства наши партнеры могут получить квалифицированную поддержку опытных инженеров.

Система менеджмента качества компании отвечает требованиям в соответствии с ГОСТ Р ИСО 9001, ГОСТ РВ 0015-002 и ЭС РД 009

### Офис по работе с юридическими лицами:

105318, г.Москва, ул.Щербаковская д.3, офис 1107, 1118, ДЦ «Щербаковский»

Телефон: +7 495 668-12-70 (многоканальный)

Факс: +7 495 668-12-70 (доб.304)

E-mail: [info@moschip.ru](mailto:info@moschip.ru)

Skype отдела продаж:

moschip.ru

moschip.ru\_4

moschip.ru\_6

moschip.ru\_9