

3.2Gbps SFP VCSEL Driver with Diagnostic Monitors

General Description

The MAX3740A is a high-speed VCSEL driver for small-form-factor (SFF) and small-form-factor pluggable (SFP) fiber optic LAN transmitters. It contains a bias generator, a laser modulator, and comprehensive safety features. The automatic power control (APC) adjusts the laser bias current to maintain average optical power over changes in temperature and laser properties. The driver accommodates common cathode and differential configurations.

The MAX3740A operates up to 3.2Gbps. It can switch up to 15mA of laser modulation current and source up to 15mA of bias current. Adjustable temperature compensation is provided to keep the optical extinction ratio within specifications over the operating temperature range. The MAX3740A interfaces with the Dallas DS1858 to meet SFF-8472 timing and diagnostic requirements. The MAX3740A accommodates various VCSEL packages, including low-cost TO-46 headers.

The MAX3740A safety circuit detects faults that could cause hazardous light levels and disables the VCSEL output. The safety circuits are compliant with SFF and SFP multisource agreements (MSA).

The MAX3740A is available in a compact 4mm × 4mm, 24-pin thin QFN package and operates over the -40°C to +85°C temperature range.

Applications

Multirate (1Gbps to 3.2Gbps) SFP/SFF Modules
Gigabit Ethernet Optical Transmitters
Fibre Channel Optical Transmitters
Infiniband Optical Transmitters

Features

- ◆ Supports all SFF-8472 Digital Diagnostics
- ◆ 2mA to 15mA Modulation Current
- ◆ 1mA to 15mA Bias Current
- ◆ Optional Peaking Current to Improve VCSEL Edge Speed
- ◆ Supports Common Cathode and Differential Configuration
- ◆ Automatic Power Control
- ◆ Safety Circuits Compliant with SFF and SFP MSAs
- ◆ 4mm × 4mm, 24-Pin Thin QFN Package

Ordering Information

PART	TEMP RANGE	PIN-PACKAGE
MAX3740AETG	-40°C to +85°C	24 Thin QFN-EP*
MAX3740AETG+	-40°C to +85°C	24 Thin QFN-EP*

+Denotes a lead(Pb)-free/RoHS-compliant package.

*EP = Exposed pad.

Typical Application Circuit

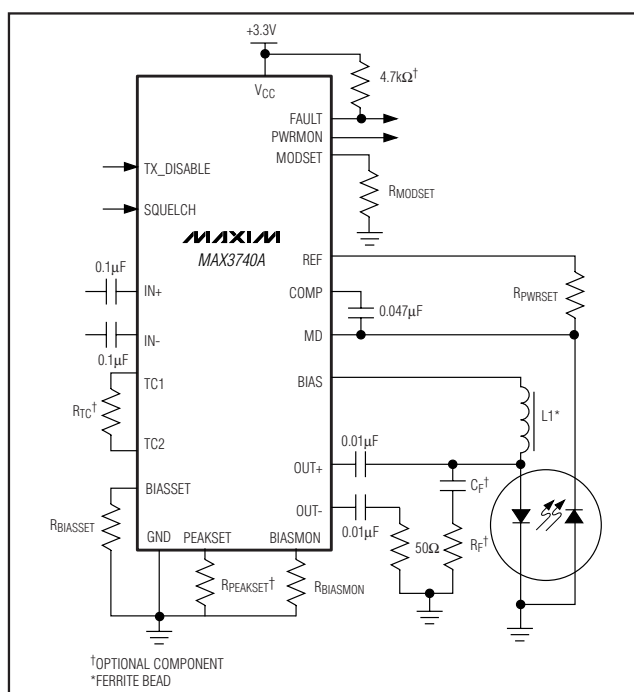

3.2Gbps SFP VCSEL Driver with Diagnostic Monitors

ABSOLUTE MAXIMUM RATINGS

Supply Voltage (V _{CC})	-0.5V to 6.0V	Continuous Power Dissipation (T _A = +85°C) 24-Lead Thin QFN (derate 20.8mW/°C above +85°C)	1354mW
Voltage at TX_DISABLE, IN+, IN-, FAULT, SQUELCH, TC1, TC2, MODSET, PEAKSET, BIASSET, BIAS, BIASMON, COMP, MD, REF, PWRMON	-0.5V to (V _{CC} + 0.5V)	Operating Temperature Range	-40°C to +85°C
Voltage at OUT+, OUT-	(V _{CC} - 2V) to (V _{CC} + 2V)	Storage Temperature Range	-55°C to +150°C
Current into FAULT	-1mA to +25mA	Lead Temperature (soldering, 10s)	+300°C
Current into OUT+, OUT-	60mA		

Stresses beyond those listed under "Absolute Maximum Ratings" may cause permanent damage to the device. These are stress ratings only, and functional operation of the device at these or any other conditions beyond those indicated in the operational sections of the specifications is not implied. Exposure to absolute maximum rating conditions for extended periods may affect device reliability.

ELECTRICAL CHARACTERISTICS

(V_{CC} = +2.97V to +3.63V, T_A = -40°C to +85°C. Typical values are at V_{CC} = +3.3V, TC1 and TC2 are shorted, PEAKSET open, T_A = +25°C, unless otherwise noted.)

PARAMETER	SYMBOL	CONDITIONS	MIN	TYP	MAX	UNITS
Supply Current	I _{CC}	SQUELCH set low, TX_DISABLE set low, peaking is not used (Note 1)	I _{MOD} = 2mA _{p-p}		32	mA
		Additional current when peaking is used (Note 2)	I _{MOD} = 15mA _{p-p}		55 68	
			Additional current when SQUELCH is high		15 20	
		Additional current when SQUELCH is high		5 10		
	I _{CC-SHDN}	Total current when TX_DISABLE is high	3.9 5			
FAULT OUTPUT						
Output High Voltage	V _{OH}	R _{LOAD} = 10kΩ to 2.97V	2.4			V
Output Low Voltage	V _{OL}	R _{LOAD} = 4.7kΩ to 3.63V			0.4	V
TX_DISABLE INPUT						
Input Impedance			4.7		10.0	kΩ
Input High Voltage	V _{IH}		2.0			V
Input Low Voltage	V _{IL}				0.8	V
Power-Down Time		The time for I _{CC} to reach I _{CC-SHDN} when TX_DISABLE transitions high		50		μs
SQUELCH						
Squelch Threshold			25		85	mV _{p-p}
Squelch Hysteresis			10			mV _{p-p}
Time to Squelch Data		(Note 3)	0.02		5.00	μs
Time to Resume from Squelch		(Note 3)	0.02		5.00	μs
BIAS GENERATOR (Note 4)						
Bias Current	I _{BIAS}	Minimum			1	mA
		Maximum	15			
Accuracy of Programmed Bias Current	ΔBIAS	5mA ≤ I _{BIAS} ≤ 15mA	-8		+8	%
		1mA ≤ I _{BIAS} ≤ 5mA	-12		+12	

3.2Gbps SFP VCSEL Driver with Diagnostic Monitors

MAX3740A

ELECTRICAL CHARACTERISTICS (continued)

($V_{CC} = +2.97V$ to $+3.63V$, $T_A = -40^\circ C$ to $+85^\circ C$. Typical values are at $V_{CC} = +3.3V$, TC1 and TC2 are shorted, PEAKSET open, $T_A = +25^\circ C$, unless otherwise noted.)

PARAMETER	SYMBOL	CONDITIONS	MIN	TYP	MAX	UNITS
Bias Current During Fault	I_{BIAS_OFF}	Current out of the BIAS pin		1.5	10	μA
BIASMON Gain		$1mA < I_{BIAS} < 3mA$	0.0875	0.105	0.1375	mA/mA
		$3mA \leq I_{BIAS} \leq 15mA$	0.085	0.105	0.125	
BIASMON Stability		(Notes 5,6)	-10		+10	%
AUTOMATIC POWER CONTROL (APC)						
MD Nominal Voltage	V_{MD}	APC loop is closed	1	$V_{REF} - 0.16$	2	V
Voltage at REF	V_{REF}		1.2	1.8	2.2	V
MD Voltage During Fault				0		V
MD Input Current		Normal operation (FAULT = low)	-2	0.7	+2	μA
APC Time Constant		$C_{COMP} = 0.047\mu F$ (Note 6)	5	20		μs
PWRMON Nominal Gain		$V_{PWRMON} / (V_{REF} - V_{MD})$	1.85	2.15	2.45	V/V
LASER MODULATOR (Note 7)						
Data Input Voltage Swing	V_{ID}	Minimum			250	mV _{P-P}
		Maximum	2200			
Output Resistance		Single-ended resistance at OUT+		80	105	Ω
		Single-ended resistance at OUT-		72	100	
Modulation Current	I_{MOD}	Minimum			2	mA _{P-P}
		Maximum	15			
Minimum Peaking Current Range				0.2		mA
Maximum Peaking Current Range				2		mA
Peaking Current Duration				80		ps
Tolerance of Programmed Modulation Current		TC1 is shorted to TC2	-10		+10	%
Minimum Programmable Temperature Coefficient				0		ppm/ $^\circ C$
Maximum Programmable Temperature Coefficient		Temperature range $0^\circ C$ to $+70^\circ C$		+5000		ppm/ $^\circ C$
Modulation Transition Time	t_R, t_F	$5mA \leq I_{MOD} \leq 15mA$, 20% to 80% (Note 6)		65	95	ps
Deterministic Jitter	DJ	$5mA \leq I_{MOD} \leq 15mA$, 3.2Gbps (Notes 6, 8)		12	20	ps _{P-P}
Random Jitter	RJ	(Note 6)		1.3	4	ps _{RMS}
Laser Modulation During Fault or while Squelch is Active	I_{MOD_OFF}			15	50	μA_{P-P}
Input Resistance		Differential resistance	85	100	115	Ω
Input Bias Voltage	V_{IN}			$V_{CC} - 0.3$		V

3.2Gbps SFP VCSEL Driver with Diagnostic Monitors

ELECTRICAL CHARACTERISTICS (continued)

($V_{CC} = +2.97V$ to $+3.63V$, $T_A = -40^\circ C$ to $+85^\circ C$. Typical values are at $V_{CC} = +3.3V$, TC1 and TC2 are shorted, PEAKSET open, $T_A = +25^\circ C$, unless otherwise noted.)

PARAMETER	SYMBOL	CONDITIONS	MIN	TYP	MAX	UNITS
SAFETY FEATURES (see the <i>Typical Operating Characteristics</i> section)						
High-Current Fault Threshold	V_{BMTH}	$V_{BIASMON} > V_{BMTH}$ causes a fault	0.7	0.8	0.9	V
V_{BIAS} Fault Threshold	V_{BTH}	V_{BIAS} referenced to V_{CC}	-0.250	-0.2	-0.150	V
Power-Monitor Fault Threshold	V_{PMTH}	$V_{PWRMON} > V_{PMTH}$ causes a fault	0.7	0.8	0.9	V
TX Disable Time	t_{OFF}	Time from rising edge of TX_DISABLE to $I_{BIAS} = I_{BIAS_OFF}$ and $I_{MOD} = I_{MOD_OFF}$ (Note 6)		1.8	5	μs
TX Disable Negate Time	t_{ON}	Time from rising edge of TX_DISABLE to I_{BIAS} and I_{MOD} at 99% of steady state (Note 6)		55	500	μs
Fault Reset Time	t_{INIT1}	Time to set $V_{FAULT} =$ low after power-on or after rising edge of TX_DISABLE (Note 6)		60	200	ms
Power-On Time	t_{INIT2}	Time after power-on to transmitter-on with TX_DISABLE low (Note 6)		60	200	ms
Fault Assert Time	t_{FAULT}	Time from fault occurrence to $V_{FAULT} =$ high; $C_{FAULT} < 20pF$, $R_{FAULT} = 4.7k\Omega$ (Note 6)		1.4	50	μs
Fault Delay Time	t_{FLTDLY}	Time from fault to $I_{BIAS} = I_{BIAS_OFF}$ and $I_{MOD} = I_{MOD_OFF}$ (Note 6)		1	5	μs
TX_DISABLE Reset	t_{RESET}	Time TX_DISABLE must be held high to reset FAULT (Note 6)			1	μs

Note 1: Supply current measurements exclude I_{BIAS} from the total current.

Note 2: Tested with $R_{PEAK} = 1.18k\Omega$.

Note 3: Measured by applying a pattern that contains $20\mu s$ of K28.5, followed by $5\mu s$ of zeros, then $20\mu s$ of K28.5, followed by $5\mu s$ of ones. Data rate is equal to 2.5Gbps, with inputs filtered using 1.8GHz Bessel filters.

Note 4: $V_{BIAS} < V_{CC} - 0.7V$.

Note 5: Variation of bias monitor gain for any single part over the range of V_{CC} , temperature, $3mA < I_{BIAS} < 15mA$.

Note 6: Guaranteed by design and characterization.

Note 7: Measured electrically with a 50Ω load AC-coupled to OUT+.

Note 8: Deterministic jitter is the peak-to-peak deviation from the ideal time crossings measured with a K28.5 bit pattern at 3.2Gbps (00111110101100000101).

3.2Gbps SFP VCSEL Driver with Diagnostic Monitors

MAX3740A

Typical Operating Characteristics

($V_{CC} = +3.3V$, $R_{TC} = 0\Omega$, PEAKSET open, measured electrically with a 50Ω load AC-coupled to OUT+, $T_A = +25^\circ C$, unless otherwise noted.)

ELECTRICAL EYE

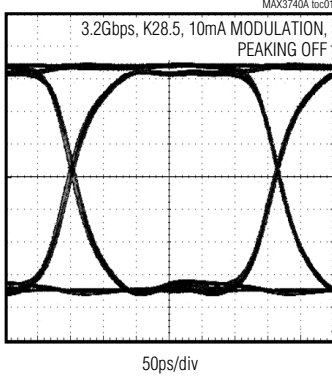

ELECTRICAL EYE WITH PEAKING

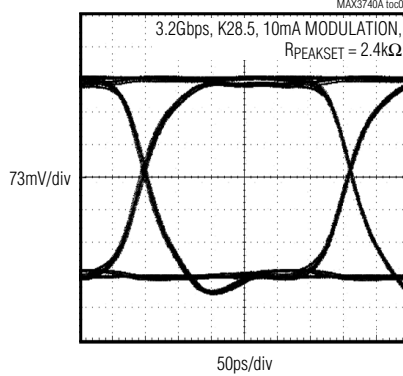

ELECTRICAL EYE WITH MAX PEAKING

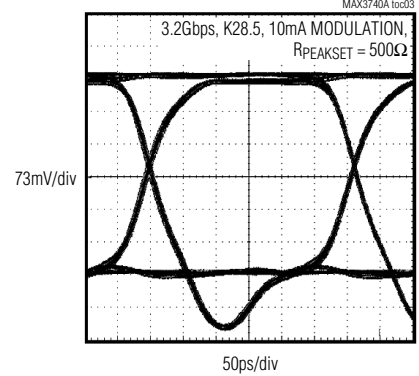

OPTICAL EYE

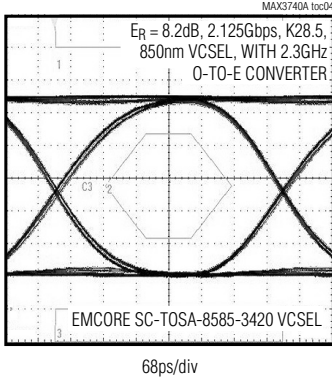

OPTICAL EYE

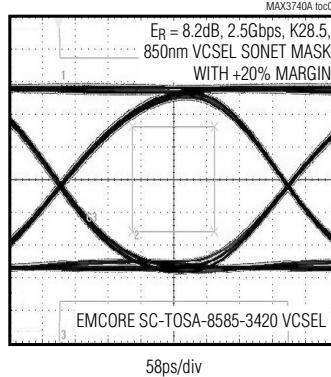

IBIASMON vs. BIAS CURRENT

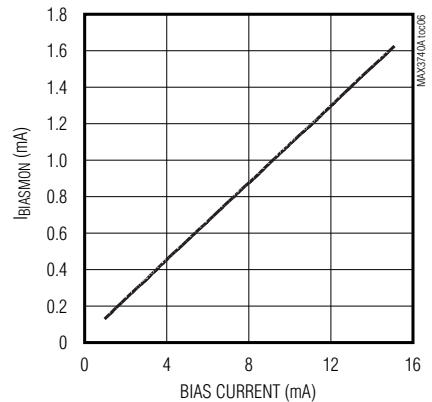

DETERMINISTIC JITTER vs. MODULATION CURRENT

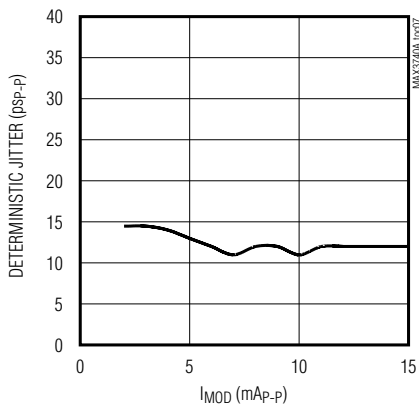

RANDOM JITTER vs. MODULATION CURRENT

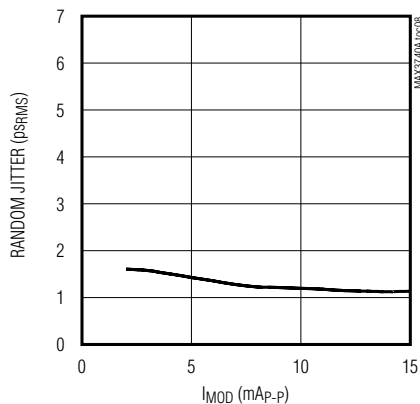

TRANSITION TIME vs. MODULATION CURRENT

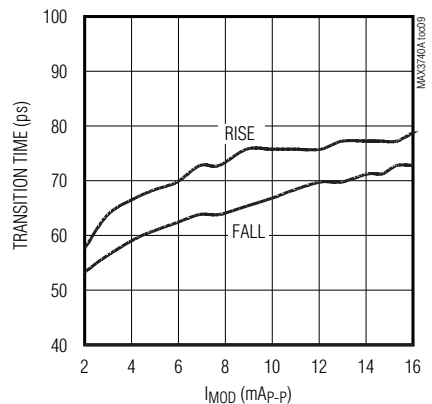

3.2Gbps SFP VCSEL Driver with Diagnostic Monitors

Typical Operating Characteristics (continued)

($V_{CC} = +3.3V$, $R_{TC} = 0\Omega$, PEAKSET open, measured electrically with a 50Ω load AC-coupled to OUT+, $T_A = +25^\circ C$, unless otherwise noted.)

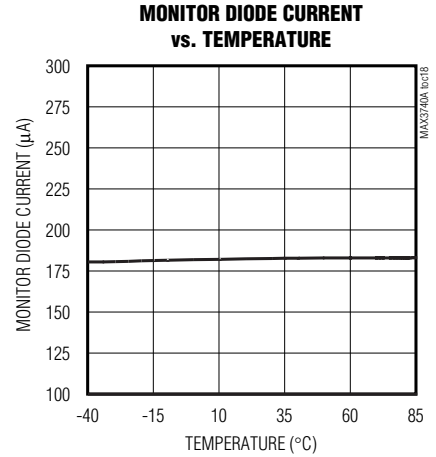
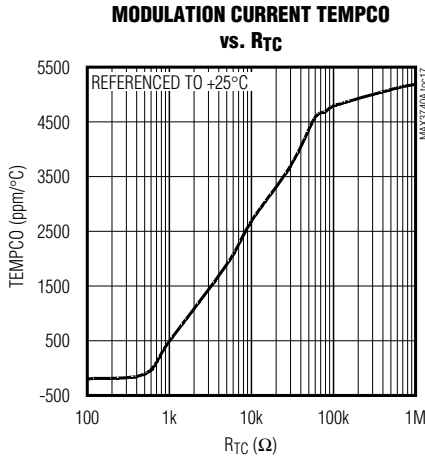
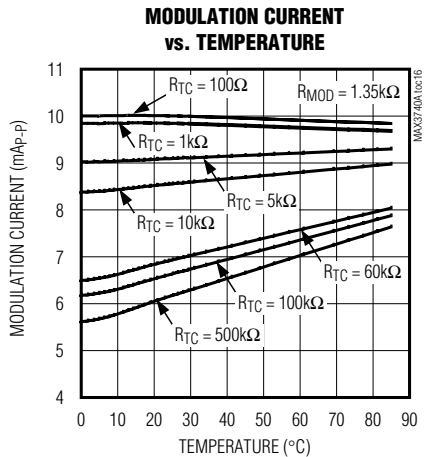
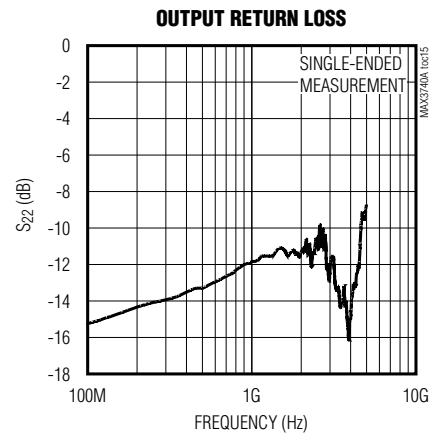
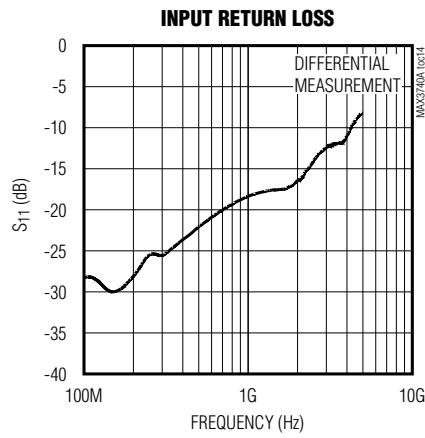
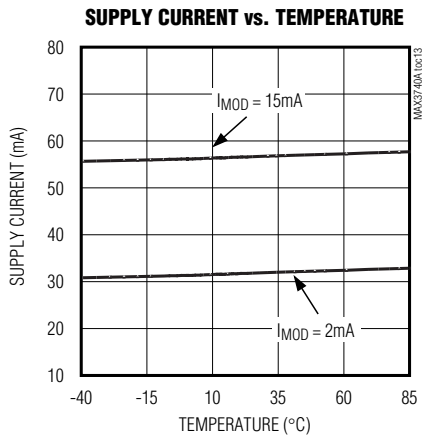
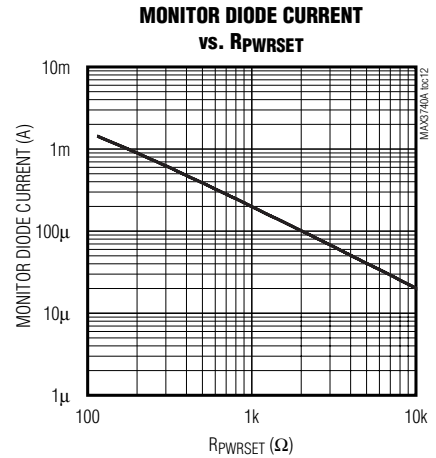
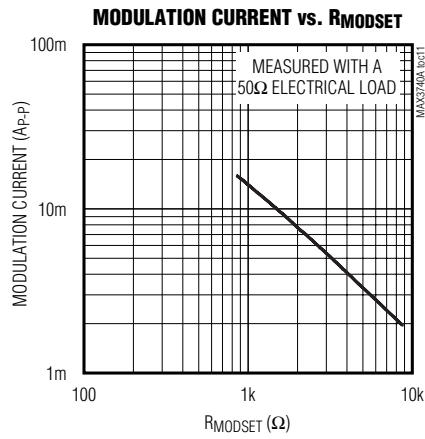
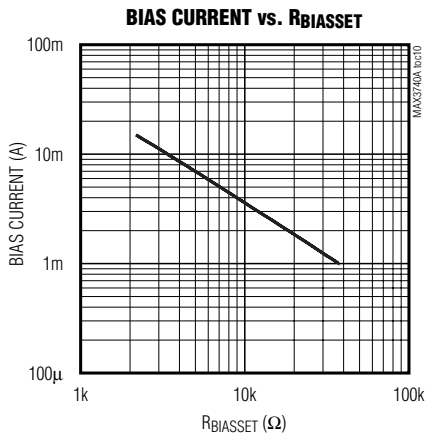

3.2Gbps SFP VCSEL Driver with Diagnostic Monitors

MAX3740A

Typical Operating Characteristics (continued)

($V_{CC} = +3.3V$, $R_{TC} = 0\Omega$, PEAKSET open, measured electrically with a 50Ω load AC-coupled to OUT+, $T_A = +25^\circ C$, unless otherwise noted.)

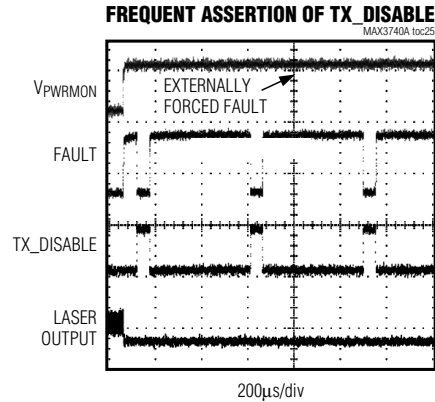
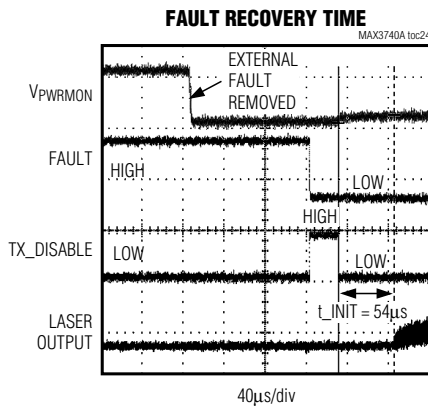
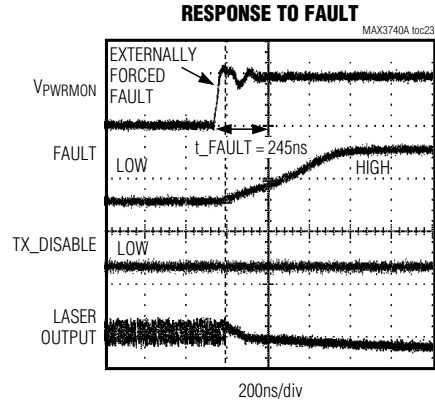
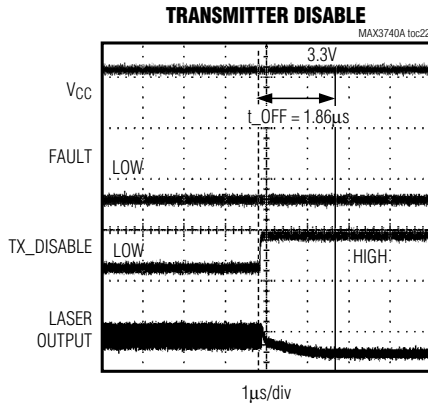
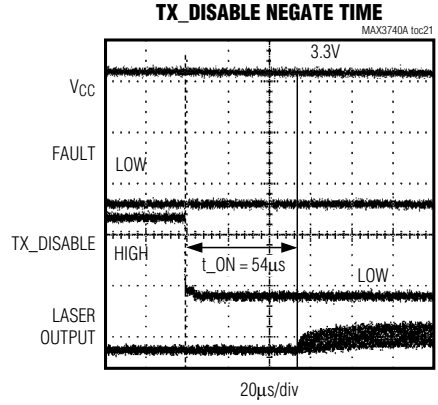
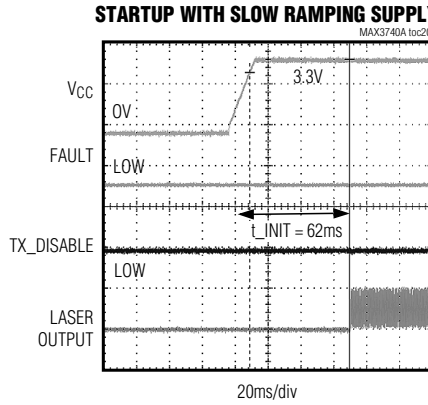
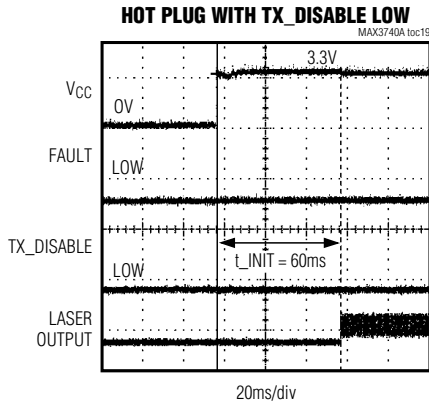

3.2Gbps SFP VCSEL Driver with Diagnostic Monitors

Pin Description

PIN	NAME	FUNCTION
1, 10, 13	GND	Ground
2	TX_DISABLE	Transmit Disable. Driver output is disabled when TX_DISABLE is high or left unconnected. The driver output is enabled when the pin is asserted low.
3	IN+	Noninverted Data Input
4	IN-	Inverted Data Input
5	FAULT	Fault Indicator. Open-drain output with ESD protection. FAULT is asserted high during a fault condition.
6	SQUELCH	Squelch Enable. Squelch is enabled when the pin is set high. Squelch is disabled when the pin is set low or left open.
7, 16, 20	VCC	+3.3V Supply Voltage
8	TC1	Temperature Compensation Set Pin 1. A resistor placed between TC1 and TC2 (R_{TC}) programs the temperature coefficient of the modulation current.
9	TC2	Temperature Compensation Set Pin 2. A resistor placed between TC1 and TC2 (R_{TC}) programs the temperature coefficient of the modulation current.
11	MODSET	Modulation Set. A resistor connected from MODSET to ground (R_{MODSET}) sets the desired modulation current amplitude.
12	PEAKSET	Peaking Current Set. A resistor connected between PEAKSET and ground ($R_{PEAKSET}$) programs the peaking current amplitude. To disable peaking, leave PEAKSET open.
14	OUT-	Inverted Modulation-Current Output
15	OUT+	Noninverted Modulation-Current Output
17	BIASSET	Bias Current Set. When a closed-loop configuration is used, connect a $1.7k\Omega$ resistor between ground and BIASSET to set the maximum bias current. When an open configuration is used, connect a resistor between BIASSET and ground ($R_{BIASSET}$) to program the VCSEL bias current.
18	BIAS	Bias Current Output
19	BIASMON	Bias Current Monitor. The output of BIASMON is a sourced current proportional to the bias current. A resistor connected between BIASMON and ground ($R_{BIASMON}$) can be used to form a ground-referenced bias monitor.
21	COMP	Compensation Pin. A capacitor between COMP and MD compensates the APC. A typical value of $0.047\mu F$ is recommended. For open-loop configuration, short the COMP pin to GND to deactivate the APC.
22	MD	Monitor Diode Connection
23	REF	Reference Pin. Reference monitor used for APC. A resistor between REF and MD (R_{PWRSET}) sets the photo monitor current when the APC loop is closed.
24	PWRMON	Average Power Monitor. The pin is used to monitor the transmit optical power. For open-loop configuration, connect PWRMON to GND.
—	EP	Exposed Pad. Ground. Must be soldered to the circuit board ground for proper thermal and electrical performance. See the <i>Layout Considerations</i> section.

3.2Gbps SFP VCSEL Driver with Diagnostic Monitors

MAX3740A

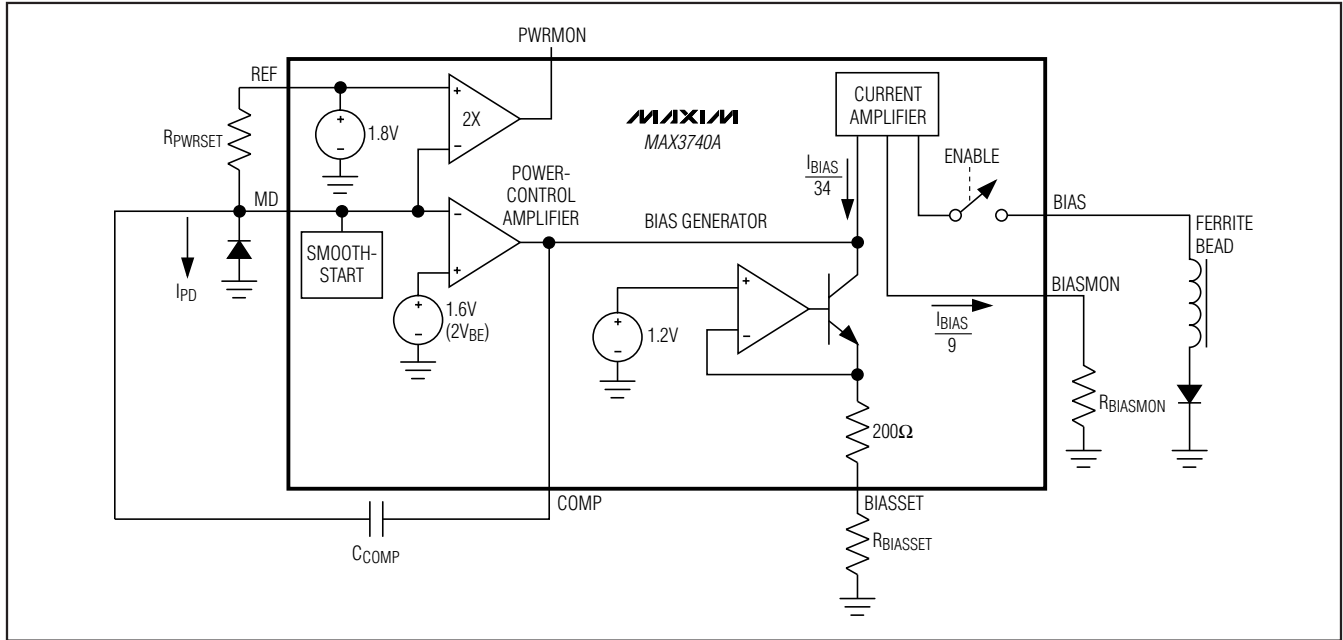

Figure 1. Bias Generator

Detailed Description

The MAX3740A contains a bias generator with automatic power control (APC), safety circuit, and a laser modulator with optional peaking compensation.

Bias Generator

Figure 1 shows the bias generator circuitry that contains a power-control amplifier and smooth-start circuitry. An internal PNP transistor provides DC laser current to bias the laser in a light-emitting state. The APC circuitry adjusts the laser-bias current to maintain average power over temperature and changing laser properties. The smooth-start circuitry prevents current spikes to the laser during power-up or enable, ensuring compliance with safety requirements and extending the life of the laser.

The MD input is connected to the cathode of a monitor diode, which is used to sense laser power. The BIAS output is connected to the anode of the laser through an inductor or ferrite bead. The power-control amplifier drives a current amplifier to control the laser's bias current. During a fault condition, the bias current is disabled.

The PWRMON output provides a voltage proportional to average laser power given by:

$$V_{PWRMON} = 2 \times I_{PD} \times R_{PWRSET}$$

The BIASMON output provides a current proportional to the laser bias current given by:

$$I_{BIASMON} = I_{BIAS} / 9$$

When APC is not used (no monitor diode, open-loop configuration) connect the COMP and PWRMON pins to GND. In this mode, the bias current is set by the resistor $R_{BIASSET}$. When a closed-loop configuration is used, connect a 1.7k Ω resistor between ground and BIASSET to set the maximum bias current.

Safety Circuit

The safety circuit contains an input disable (TX_DISABLE), a latched fault output (FAULT), and fault detectors (Figure 2). This circuit monitors the operation of the laser driver and forces a shutdown (disables laser) if a fault is detected (Table 1). Table 2 contains the circuit's response to various single-point failures. The transmit fault condition is latched until reset by a toggle of TX_DISABLE or V_{CC}. The FAULT pin should be pulled high with a 4.7k Ω to 10k Ω resistor.

Table 1. Fault Conditions

PIN	FAULT CONDITION
BIAS	$V_{BIAS} > V_{CC} - 0.2V$
BIASMON	$V_{BIASMON} > 0.8V$
PWRMON	$V_{PWRMON} > 0.8V$

3.2Gbps SFP VCSEL Driver with Diagnostic Monitors

Table 2. Circuit Response to Various Single-Point Faults (Closed-Loop APC Configuration)

PIN NAME	CIRCUIT RESPONSE TO V _{CC} SHORT	CIRCUIT RESPONSE TO GND SHORT
FAULT	Does not affect laser power.	Does not affect laser power.
TX_DISABLE	Modulation and bias current are disabled.	Normal condition for circuit operation.
IN+	Does not affect laser power.	Does not affect laser power.
IN-	Does not affect laser power.	Does not affect laser power.
SQUELCH	Does not affect laser power.	Does not affect laser power.
TC1	Does not affect laser power.	Does not affect laser power.
TC2	The laser modulation is increased, but average power is not affected.	Modulation current is disabled.
MODSET	Modulation current is disabled.	The laser modulation is increased, but average power is not affected.
PEAKSET	Does not affect laser power.	Does not affect laser power.
OUT+	Modulation current is disabled.	Modulation current is disabled.
OUT-	Does not affect laser power.	Does not affect laser power.
BIASSET	Laser bias is disabled.	Fault state* occurs.
BIAS	Fault state* occurs. Note that VCSEL emissions may continue; care must be taken to prevent this condition.	Disables VCSEL.
BIASMON	Fault state* occurs.	Does not affect laser power.
COMP	The bias current is reduced, and the average power of the laser output is reduced.	I _{BIAS} increases to the value determined by R _{BIASSET} ; if the bias monitor fault threshold is exceeded, a fault is signaled.
MD	I _{BIAS} increases to the value determined by R _{BIASSET} ; if the bias-monitor fault threshold is exceeded, a fault is signaled.	The bias current is reduced, and the average power of the laser output is reduced.
REF	I _{BIAS} increases to the value determined by R _{BIASSET} ; if the bias-monitor fault threshold is exceeded, a fault is signaled.	The bias current is reduced, and the average power of the laser output is reduced.
PWRMON	Fault state* occurs.	Does not affect laser power.

*A fault state asserts the FAULT pin, disables the modulator output, and disables the bias output.

Modulation Circuit

The modulation circuitry consists of an input buffer, a current mirror, and a high-speed current switch (Figure 3). The modulator drives up to 15mA of modulation into a 50Ω VCSEL load.

The amplitude of the modulation current is set with resistors at MODSET and temperature coefficient (TC1, TC2) pins. The resistor at MODSET (R_{MODSET}) programs the temperature-stable portion of the modulation current, and the resistor between TC1 and TC2 (R_{TC}) programs the temperature coefficient of the modulation current. For appropriate R_{TC} and R_{MODSET} values, see the *Typical Operating Characteristics* section.

Design Procedure

Select Laser

Select a communications-grade laser with a rise time of 260ps or better for 1.25Gbps, or 130ps or better for 2.5Gbps applications. Use a high-efficiency laser that requires low modulation current and generates a low-voltage swing. Trim the leads to reduce laser package inductance. The typical package leads have inductance of 25nH per inch (1nH/mm). This inductance causes a large voltage swing across the laser. A compensation filter network can also be used to reduce ringing, edge speed, and voltage swing (see the *Designing the Compensation Filter Network* section).

3.2Gbps SFP VCSEL Driver with Diagnostic Monitors

MAX3740A

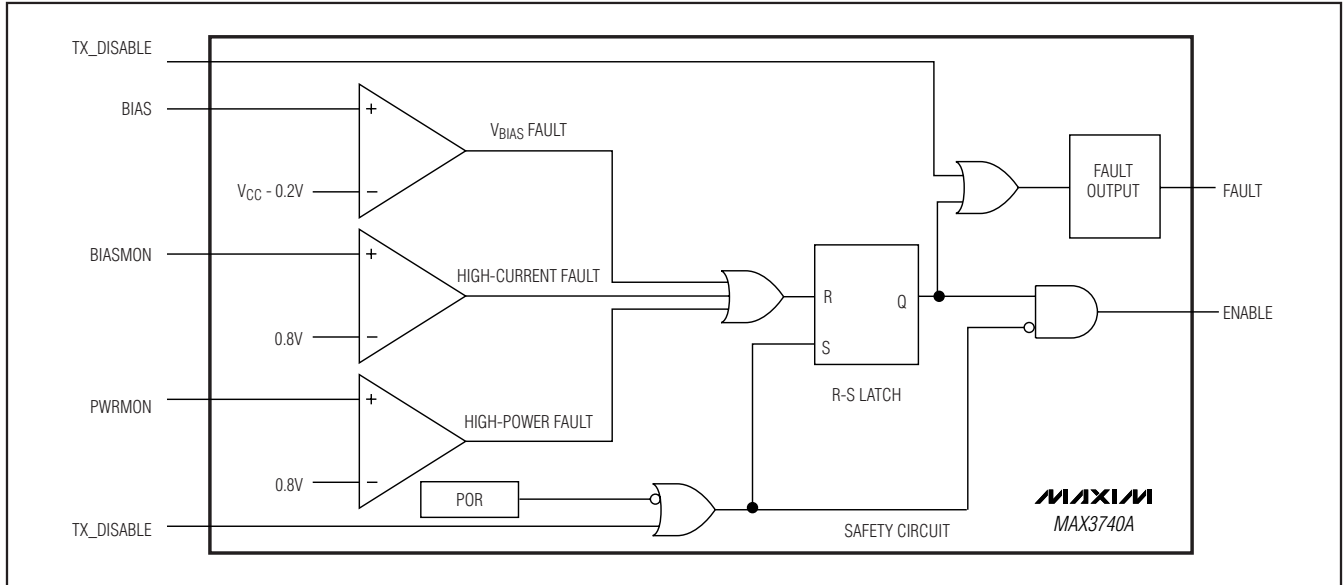

Figure 2. Safety Circuit

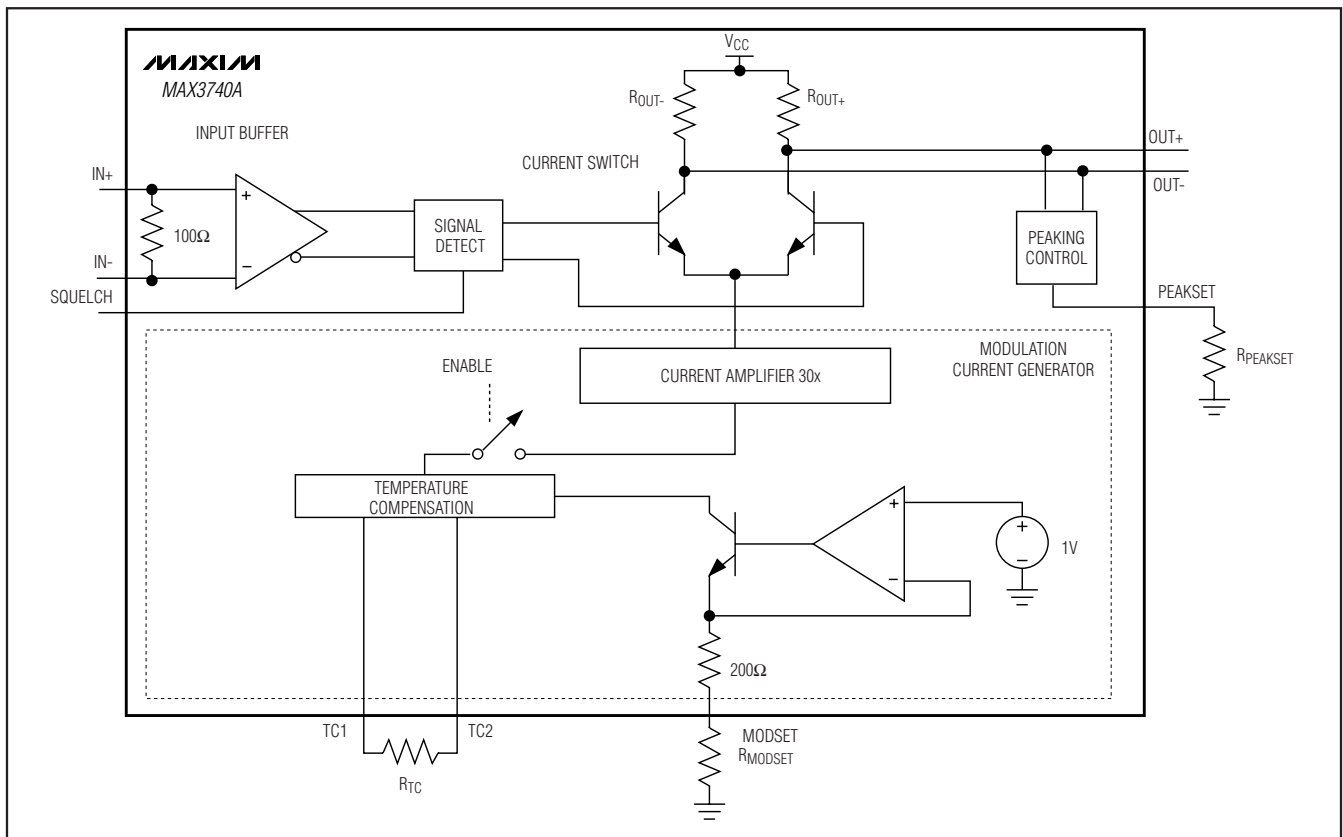

Figure 3. Modulation Circuit

3.2Gbps SFP VCSEL Driver with Diagnostic Monitors

Programming Modulation Current

The modulation current output of the MAX3740A is controlled by a resistor (R_{MODSET}) placed between MODSET and ground. The R_{MODSET} resistor controls the amount of current being sourced to the VCSEL. The modulation current is given by the following:

$$I_{MOD} = [(I_{MODSET}) \times 30] \times \left[\frac{R_{OUT+}}{R_{OUT+} + R_{LOAD}} \right]$$

$$I_{MOD} = \left[\left(\frac{1}{200 + R_{MODSET}} \right) \times 30 \right] \times \left[\frac{R_{OUT+}}{R_{OUT+} + R_{LOAD}} \right]$$

It is important to note that the modulation current being sourced by the MAX3740A is affected by the load impedance of the VCSEL. The Modulation Current vs. R_{MODSET} graph in the *Typical Operating Characteristics* shows the current into a 50Ω electrical load.

Programming Bias Current

The bias current output of the MAX3740A is controlled by a resistor ($R_{BIASSET}$) placed between BIASSET and ground. In open-loop operation the $R_{BIASSET}$ controls the bias current level of the VCSEL. In closed-loop operation the $R_{BIASSET}$ controls the maximum bias current provided by the APC. The bias current is given by the following:

$$I_{BIAS} = (I_{BIASSET}) \times 34$$

$$I_{BIAS} = \left(\frac{1.2}{200 + R_{BIASSET}} \right) \times 34$$

The Bias Current vs. $R_{BIASSET}$ graph is also shown in the *Typical Operating Characteristics*.

Photodiode Selection

To ensure stable operation of the APC circuit, the time constant of the MD node should be shorter than the APC time constant. ($t_{APC} = 5\mu s$ if $C_{APC} = 0.047\mu F$).

$$t_{MD} \leq \frac{t_{APC}}{20}, \quad R_{MD} \times C_{MD} \leq \frac{5\mu s}{20} = 250ns$$

For typical $I_{PD} = 400\mu A$, $R_{PWRSET} = 500\Omega$, select a photodiode with capacitance less than $500pF$.

Programming Modulation-Current Tempco

Compute the required modulation tempco from the slope efficiency of the laser at $T_A = +25^\circ C$ and at a higher temperature. Then select the value of R_{TC} from the *Typical Operating Characteristics*. For example, suppose a laser has a slope efficiency (SE) of

$0.021mW/mA$ at $+25^\circ C$, which reduces to $0.018mW/mA$ at $+85^\circ C$. The temperature coefficient is given by the following:

$$\text{Laser tempco} = \frac{(SE_{85} - SE_{25})}{SE_{25} \times (85 - 25)} \times 1E6$$

$$= -2380ppm/^\circ C$$

From the *Typical Operating Characteristics*, the value of R_{TC} , which offsets the tempco of the laser, is $9k\Omega$. If modulation temperature compensation is not desired, short TC1 and TC2.

Programming the APC Loop

Program the average optical power by adjusting R_{PWRSET} . To select the resistance, determine the desired monitor current to be maintained over temperature and lifetime. See the Monitor Diode Current vs. R_{PWRSET} graph in the *Typical Operating Characteristics* section, and select the value of R_{PWRSET} that corresponds to the required current.

Input Termination Requirements

The MAX3740A data inputs are SFP MSA compatible. On-chip 100Ω differential input impedance is provided for optimal termination (Figure 4). Because of the on-chip biasing network, the MAX3740A inputs self-bias to the proper operating point to accommodate AC-coupling.

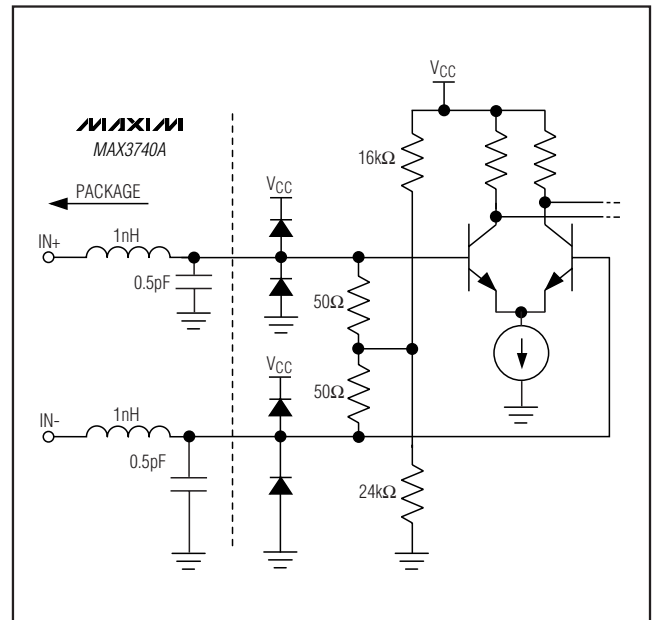

Figure 4. Simplified Input Structure

3.2Gbps SFP VCSEL Driver with Diagnostic Monitors

MAX3740A

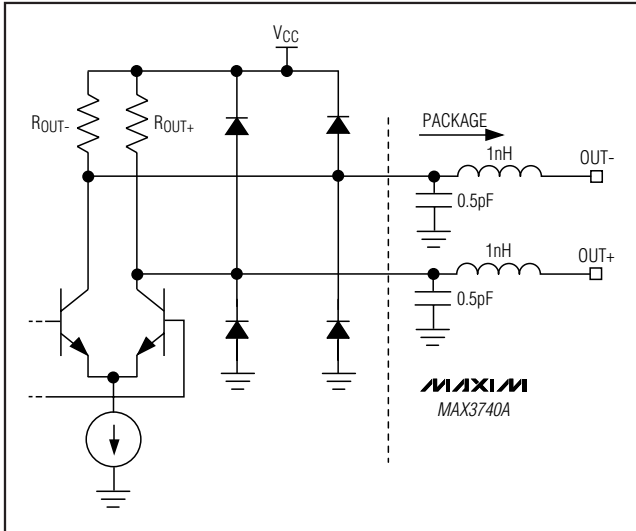

Figure 5. Simplified Output Structure

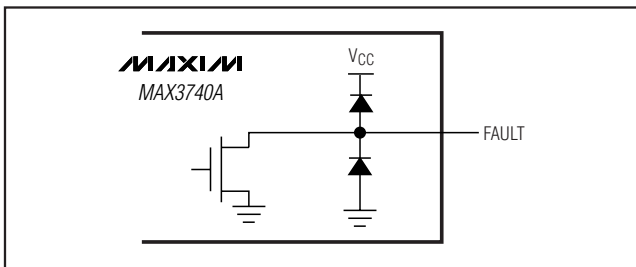

Figure 6. Fault Circuit Interface

Applications Information

Interface Models

Figures 4 and 5 show simplified input and output circuits for the MAX3740A laser driver. Figure 6 shows the fault circuit interface.

Layout Considerations

To minimize inductance, keep the connections between the MAX3740A output pins and laser diode as short as possible. Use good high-frequency layout techniques and multilayer boards with uninterrupted ground planes to minimize EMI and crosstalk.

Designing the Compensation Filter Network

Laser package inductance causes the laser impedance to increase at high frequencies, leading to ringing, overshoot, and degradation of the laser output. A laser compensation filter network can be used to reduce the laser impedance at high frequencies, thereby reducing output ringing and overshoot.

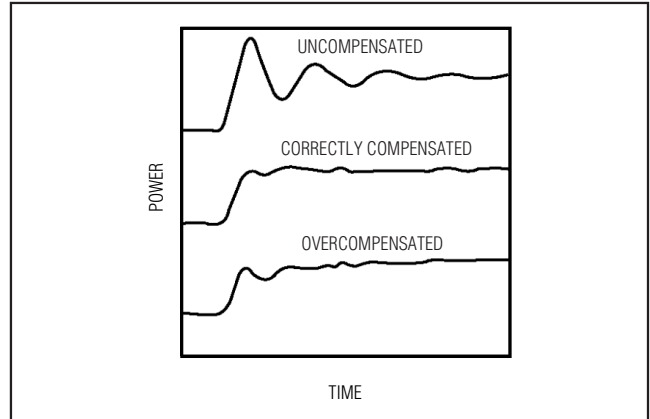

Figure 7. Laser Compensation

The compensation components (R_F and C_F) are most easily determined by experimentation. Begin with $R_F = 50\Omega$ and $C_F = 1\text{pF}$. Increase C_F until the desired transmitter response is obtained (Figure 7). Refer to Application Note HFAN-2-0: *Interfacing Maxim Laser Drives with Laser Diodes* for more information.

Exposed-Pad (EP) Package

The exposed pad on the 24-pin thin QFN provides a very low thermal resistance path for heat removal from the IC. The pad is also electrical ground on the MAX3740A and must be soldered to the circuit board ground for proper thermal and electrical performance. Refer to Maxim Application Note HFAN-08.1: *Thermal Considerations for QFN and Other Exposed-Pad Packages* for additional information.

Laser Safety and IEC 825

The International Electrotechnical Commission (IEC) determines standards for hazardous light emissions from fiber optic transmitters. IEC 825 defines the maximum light output for various hazard levels. The MAX3740A provides features that facilitate compliance with IEC 825. A common safety precaution is single-point fault tolerance, whereby one unplanned short, open, or resistive connection does not cause excess light output. Using this laser driver alone does not ensure that a transmitter design is compliant with IEC 825. The entire transmitter circuit and component selections must be considered. Customers must determine the level of fault tolerance required by their applications, recognizing that Maxim products are not designed or authorized for use as components in systems intended for surgical implant into the body, for applications intended to support or sustain life, or for any other application where the failure of a Maxim product could create a situation where personal injury or death may occur.

3.2Gbps SFP VCSEL Driver with Diagnostic Monitors

Functional Diagram

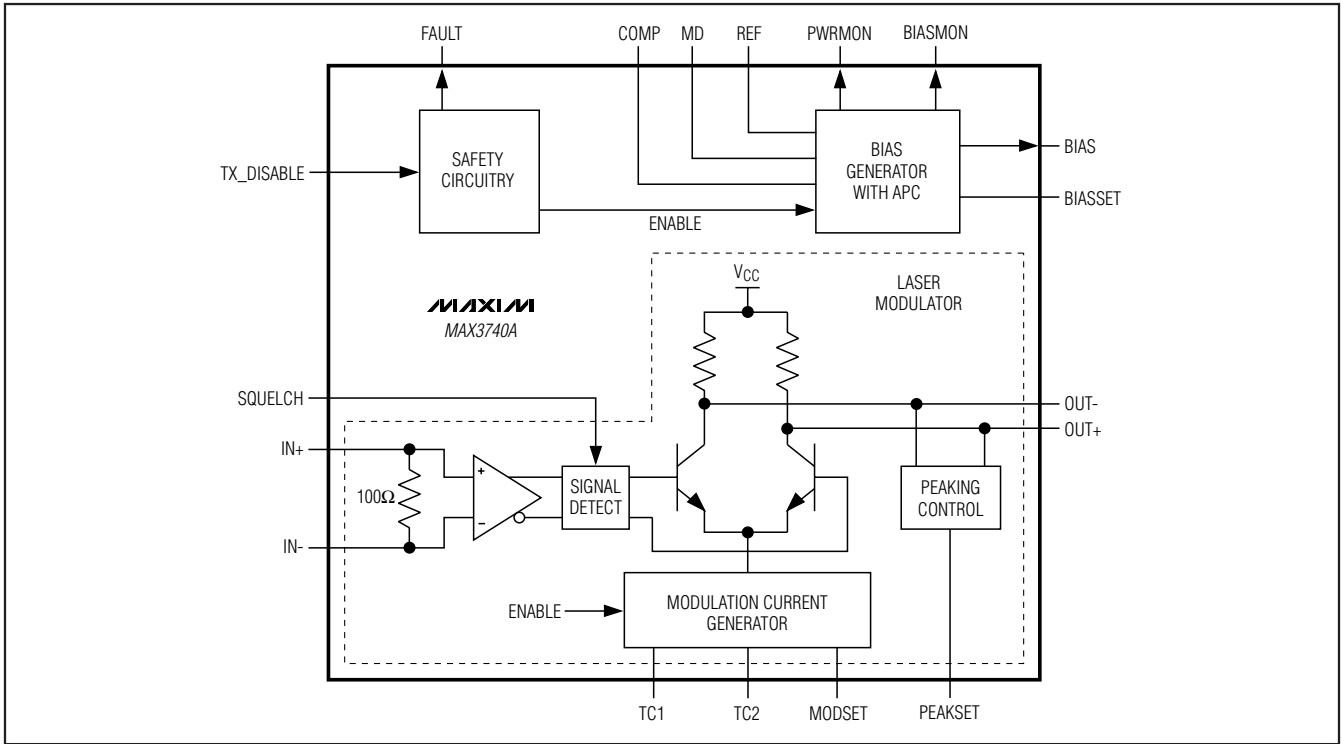

Chip Information

TRANSISTOR COUNT: 3806

PROCESS: SiGe BIPOLAR

Package Information

For the latest package outline information and land patterns, go to www.maxim-ic.com/packages. Note that a "+", "#", or "-" in the package code indicates RoHS status only. Package drawings may show a different suffix character, but the drawing pertains to the package regardless of RoHS status.

PACKAGE TYPE	PACKAGE CODE	DOCUMENT NO.
24 TQFN-EP (4mm x 4mm x 0.75mm)	T2444-4	21-0139

Pin Configuration

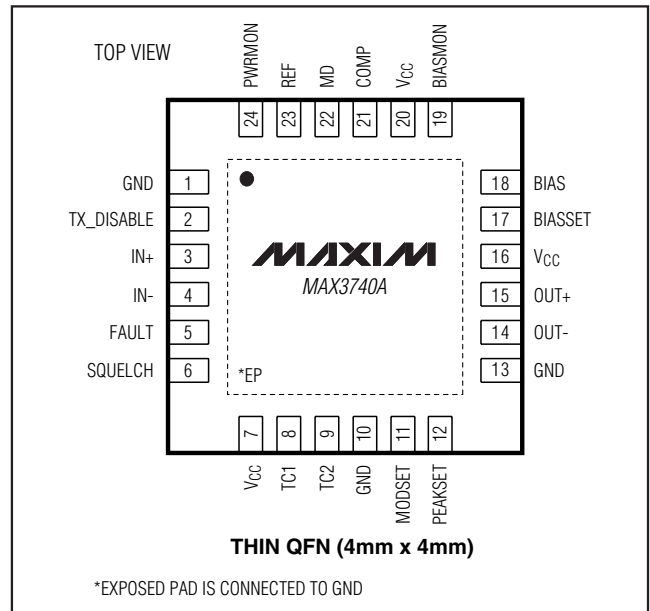

3.2Gbps SFP VCSEL Driver with Diagnostic Monitors

Revision History

REVISION NUMBER	REVISION DATE	DESCRIPTION	PAGES CHANGED
0	12/03	Initial release.	—
1	6/04	Added a lead-free package to the <i>Ordering Information</i> table.	1
2	5/06	In the <i>Electrical Characteristics</i> table, modified the MD Nominal Voltage parameter of $V_{REF} - 0.2V$ (typ) to $V_{REF} - 0.16V$ (typ).	3
		Modified Figure 1 to clarify the meaning of the arrow labeled I_{PD} .	9
3	1/10	Updated the <i>Package Information</i> section to correct the package code.	14

MAX3740A

Maxim cannot assume responsibility for use of any circuitry other than circuitry entirely embodied in a Maxim product. No circuit patent licenses are implied. Maxim reserves the right to change the circuitry and specifications without notice at any time.

Maxim Integrated Products, 120 San Gabriel Drive, Sunnyvale, CA 94086 408-737-7600 _____ 15

Данный компонент на территории Российской Федерации

Вы можете приобрести в компании MosChip.

Для оперативного оформления запроса Вам необходимо перейти по данной ссылке:

<http://moschip.ru/get-element>

Вы можете разместить у нас заказ для любого Вашего проекта, будь то серийное производство или разработка единичного прибора.

В нашем ассортименте представлены ведущие мировые производители активных и пассивных электронных компонентов.

Нашей специализацией является поставка электронной компонентной базы двойного назначения, продукции таких производителей как XILINX, Intel (ex.ALTERA), Vicor, Microchip, Texas Instruments, Analog Devices, Mini-Circuits, Amphenol, Glenair.

Сотрудничество с глобальными дистрибьюторами электронных компонентов, предоставляет возможность заказывать и получать с международных складов практически любой перечень компонентов в оптимальные для Вас сроки.

На всех этапах разработки и производства наши партнеры могут получить квалифицированную поддержку опытных инженеров.

Система менеджмента качества компании отвечает требованиям в соответствии с ГОСТ Р ИСО 9001, ГОСТ РВ 0015-002 и ЭС РД 009

Офис по работе с юридическими лицами:

105318, г.Москва, ул.Щербаковская д.3, офис 1107, 1118, ДЦ «Щербаковский»

Телефон: +7 495 668-12-70 (многоканальный)

Факс: +7 495 668-12-70 (доб.304)

E-mail: info@moschip.ru

Skype отдела продаж:

moschip.ru

moschip.ru_4

moschip.ru_6

moschip.ru_9